



**Version 5**

**User Manual**



# Table of Contents

<b>1</b>	<b>HAZARD WARNING</b>	<b>.....16</b>
<b>2</b>	<b>CONFORMITY AND ELECTRICAL INFORMATION</b>	<b>.....17</b>
<b>3</b>	<b>WHAT'S NEW ?</b>	<b>.....21</b>
<b>4</b>	<b>FIRST STEPS AND TROUBLESHOOTING</b>	<b>.....64</b>
4.1	PRODUCT OVERVIEW	.....65
4.2	How to connect via VNC Remote	.....69
4.3	How to see the taskbar	.....73
4.4	How to ping other computers and check your IP and MAC address	.....74
4.5	How to check and change the resolution	.....77
4.6	How to access log files	.....78
4.7	How to install a new Pandoras Box version	.....80
4.8	How to copy files to a remote PC	.....82
4.9	How to copy content to your hard drive	.....83
4.10	How to copy content to the project	.....86
4.11	Basic steps in the user interface	.....89
<b>5</b>	<b>PANDORAS BOX</b>	<b>.....94</b>
5.1	CONTENT	.....94
5.1.1	DISPLAY & CONTENT FORMATS	.....94
5.1.2	DEFINING CONTENT RESOLUTION	.....94
5.1.3	OUTPUT RESOLUTION TABLE	.....94
5.1.4	AUDIO FORMATS	.....94
5.1.5	IMAGE FORMATS	.....94
5.1.6	IMAGE SEQUENCE FORMATS	.....94
5.1.7	VIDEO FORMATS	.....94
5.1.8	ENCODING	.....94
5.1.8.1	ENCODER EXTENSION	.....104
5.1.8.2	ENCODING (up to Version 4.5)	.....109
5.1.8.3	COOLUX CODEC	.....115
5.1.8.4	QUICKTIME CONVERTER	.....117
5.2	USER INTERFACE - MASTER	.....126
5.2.1	STARTUP DIALOG	.....126
5.2.2	MENU BAR	.....126
5.2.2.1	FILE MENU	.....129
5.2.2.2	EDIT MENU	.....130
5.2.2.3	TABS MENU	.....131
5.2.2.4	TOOLS MENU	.....132
5.2.2.5	BACKUP MENU	.....132
5.2.3	TABS OVERVIEW	.....126
5.2.3.1	ACTIVE VALUES	.....135
5.2.3.2	AEON FX	.....136
5.2.3.3	ASSETS	.....137
5.2.3.4	CONFIGURATION	.....139
5.2.3.4.1	DEVICES / PARAMETERS	.....139
5.2.3.4.2	RESOURCES	.....141
5.2.3.4.3	SEQUENCE	.....144
5.2.3.4.4	NETWORK	.....146
5.2.3.4.5	REMOTE CONTROL PROTOCOLS	.....146
5.2.3.4.6	STARTUP	.....149
5.2.3.4.7	UNIT MANAGEMENT	.....149
5.2.3.4.8	PREVIEW DISPLAY	.....151
5.2.3.4.9	LOCAL PREVIEW	.....153
5.2.3.4.10	RENDER ENGINE	.....153

5.2.3.4.11	ASIO AUDIO	....156
5.2.3.4.12	EXTENSIONS	....157
5.2.3.4.13	SMPTE TIME CODE	....157
5.2.3.4.14	WEB SERVER	....158
5.2.3.4.15	CACHE	....159
5.2.3.5	CONTROLLER SETUP	.....159
5.2.3.6	CURVE EDITOR	.....161
5.2.3.7	DEVICE CONTROL	.....164
5.2.3.7.1	PARAMETER VALUE READOUT	....164
5.2.3.7.2	PARAMETER VALUE RANGES	....164
5.2.3.7.3	CHANGING PARAMETER VALUES	....165
5.2.3.7.4	LINKING PARAMETERS	....165
5.2.3.7.5	EXPAND & COLLAPSE PARAMETER SECTIONS	....167
5.2.3.8	DEVICE TREE	.....168
5.2.3.8.1	BUILD-UP	....170
5.2.3.8.2	CONTEXT MENUS	....172
5.2.3.8.3	DEVICE SELECTION	....176
5.2.3.8.4	STRUCTURE OF THE DEVICE VIEW	....178
5.2.3.9	DEVICE TYPES	.....181
5.2.3.10	DEVICE VIEWER	.....182
5.2.3.11	ENCODER EXTENSION TAB	.....182
5.2.3.12	FIREFLY PARTICLES	.....182
5.2.3.13	GROUP VIEW	.....187
5.2.3.14	INSPECTOR	.....188
5.2.3.14.1	FILE INSPECTOR	....190
5.2.3.14.1.1	ATTACHING FILES	..192
5.2.3.14.2	BROWSER INSPECTOR	....192
5.2.3.14.3	CANVAS INSPECTOR	....193
5.2.3.14.4	IMAGE SEQUENCE INSPECTOR	....194
5.2.3.14.5	OBJECT INSPECTOR	....195
5.2.3.14.6	PLAYLIST INSPECTOR	....196
5.2.3.14.7	TEXT INSPECTOR	....197
5.2.3.14.8	FOLDER INSPECTOR	....198
5.2.3.14.9	TAB BUTTON INSPECTOR	....199
5.2.3.14.10	SEQUENCE INSPECTOR	....200
5.2.3.14.11	CLIP SUMMARY INSPECTOR	....201
5.2.3.14.12	CLIP INSPECTOR	....202
5.2.3.14.13	PARAMETER KEYFRAME INSPECTOR	....203
5.2.3.14.14	CUE INSPECTOR	....204
5.2.3.14.15	DEVICE INSPECTOR	....206
5.2.3.14.16	VIDEO AND GRAPHIC LAYER INSPECTOR	....208
5.2.3.14.17	POINTER INSPECTOR	....210
5.2.3.14.18	LIGHT LAYER INSPECTOR	....211
5.2.3.14.19	TRACK INSPECTOR	....213
5.2.3.14.20	CAMERA INSPECTOR	....214
5.2.3.14.21	OUTPUT INSPECTOR	....215
5.2.3.15	MEDIA ENCRYPTION	.....216
5.2.3.15.1	ENCRYPTING MEDIA	....218
5.2.3.15.2	DECRYPTING MEDIA	....221
5.2.3.15.3	UPDATING A POLICY	....222
5.2.3.16	PATCH	.....222
5.2.3.16.1	SITE PATCH	....223
5.2.3.16.2	SEQUENCE PATCH	....228
5.2.3.16.3	DMX START ADDRESS	....228
5.2.3.17	PLAYLIST	.....229
5.2.3.18	PRESET VIEW	.....230
5.2.3.19	PREVIEW	.....232
5.2.3.19.1	INCLUDING SITES INTO THE PREVIEW	....233
5.2.3.19.2	SELECT PREVIEW: GLOBAL CAM OR OUTPUT	....234

5.2.3.19.3	PREVIEW NAVIGATION	....237
5.2.3.19.4	PREVIEW HANDLES AND WIREFRAMES	....238
5.2.3.19.5	INTERACTIVE PREVIEW: PIVOT HANDLES	....239
5.2.3.19.6	INTERACTIVE PREVIEW: CONTENT AS INTERFACE (LAYER PICKING)	....244
5.2.3.20	PROJECT	.....248
5.2.3.20.1	MEDIA FILES	....248
5.2.3.20.2	SEQUENCES	....251
5.2.3.20.3	GROUPS	....251
5.2.3.20.4	PRESETS	....253
5.2.3.20.5	VIEWS	....257
5.2.3.20.6	TABS	....258
5.2.3.21	SEQUENCE	.....260
5.2.3.21.1	OVERVIEW	....261
5.2.3.21.2	SEQUENCE BUTTON BAR	....261
5.2.3.21.3	CONTROL	....261
5.2.3.21.4	COMMANDS	....262
5.2.3.21.5	PROGRAMMING	....264
5.2.3.21.6	TRACKING	....269
5.2.3.22	SEQUENCE CONTROL	.....273
5.2.3.23	TASKMANAGER	.....275
5.2.3.24	TEXT INPUT EDITOR	.....277
5.2.3.25	THUMBNAIL VIEWER	.....280
5.2.3.26	VIDEO EXPORT	.....281
5.2.3.27	VIDEO RECORDING	.....284
5.2.3.28	VIEW TAB	.....286
5.2.3.29	VIRTUAL SITE	.....286
5.2.4	LAYOUT	.....126
5.2.5	KEYBOARD SHORTCUTS	.....126
5.3	USER INTERFACE - CLIENT	.....294
5.3.1	CLIENT LIVE INPUT CONFIGURATION	.....294
5.3.2	CLIENT KEYBOARD SHORTCUTS	.....294
5.4	DEVICE CONTROL	.....296
5.4.1	V5 VIDEO PROCESSING PIPELINE	.....296
5.4.2	VIDEO LAYER CONTROL	.....296
5.4.2.1	MEDIA / MESH	.....299
5.4.2.2	OPACITY	.....301
5.4.2.3	PLAYBACK	.....302
5.4.2.4	AUDIO	.....303
5.4.2.5	POSITION	.....304
5.4.2.6	ROTATION	.....306
5.4.2.7	SCALE	.....309
5.4.2.8	ROTATION PIVOT	.....311
5.4.2.9	SCALE PIVOT	.....313
5.4.2.10	BLEND MODE	.....315
5.4.2.11	FX	.....319
5.4.2.11.1	ADDING FX	....319
5.4.2.11.2	FX ORDER	....321
5.4.2.11.3	FX PARAMETER	....323
5.4.2.11.4	COPY / PASTE OF FX	....324
5.4.2.11.5	REMOVING FX	....328
5.4.2.11.6	FX LIST	....328
5.4.2.11.7	ANIMATION	....328
5.4.2.11.8	ANTI-ALIASING	....329
5.4.2.11.9	BLUR	....330
5.4.2.11.10	CAMERA PROJECTION	....342
5.4.2.11.11	COLOR EFFECTS	....343
5.4.2.11.12	COLOR EFFECTS - CROP	....352
5.4.2.11.13	COLOR EFFECTS - SOFTBORDER	....363

5.4.2.11.14	COLOR SHIFT	....373
5.4.2.11.15	COMPOSITING	....386
5.4.2.11.16	CROPPING	....391
5.4.2.11.17	DISTORT	....403
5.4.2.11.18	FRACTALS	....415
5.4.2.11.19	FX COLLECTIONS	....416
5.4.2.11.20	GENERATOR	....417
5.4.2.11.21	GEOMETRY	....419
5.4.2.11.22	GRADIENTS	....423
5.4.2.11.23	IMAGE ADJUST	....434
5.4.2.11.24	IMAGE ADJUST - CROP	....445
5.4.2.11.25	IMAGE ADJUST - IRIS	....452
5.4.2.11.26	IMAGE ADJUST - MEDIAMASK	....460
5.4.2.11.27	IMAGE ADJUST - SOFTBORDER	....466
5.4.2.11.28	KEYING	....472
5.4.2.11.29	LIGHTING	....484
5.4.2.11.30	LIGHTING - TEXTURE PROJECTION	....493
5.4.2.11.31	MASKING	....500
5.4.2.11.32	MIRROR	....507
5.4.2.11.33	OVERLAY	....508
5.4.2.11.34	PATTERN	....520
5.4.2.11.35	REMAP	....525
5.4.2.11.36	SHADOWS	....527
5.4.2.11.37	SHAPES	....527
5.4.2.11.38	SHARPEN	....544
5.4.2.11.39	SNAPSHOT	....547
5.4.2.11.40	SOFTEDGE	....548
5.4.2.11.41	SOFTEDGE - SOFTEDGE P-CURVE ALPHA	....550
5.4.2.11.42	SOFTEDGE - SOFTEDGE P-CURVE ALPHA GAMMA	....552
5.4.2.11.43	STROBE	....553
5.4.2.11.44	STYLIZE	....555
5.4.2.11.45	TRANSITION	....558
5.4.2.11.46	UV MAPPING	....565
5.4.2.11.47	WARP	....576
5.4.3	GRAPHIC LAYER CONTROL	.....296
5.4.4	AUDIO TRACKS	.....296
5.4.4.1	MEDIA	.....578
5.4.4.2	PLAYBACK TRANSPORT	.....579
5.4.4.3	VOLUME	.....579
5.4.4.4	INPOINT / OUTPOINT	.....580
5.4.4.5	PAN	.....580
5.4.5	POINTER LAYER CONTROL	.....296
5.4.6	LIGHT LAYER CONTROL	.....296
5.4.6.1	MEDIA	.....583
5.4.6.2	INTENSITY	.....584
5.4.6.3	PLAYBACK	.....584
5.4.6.4	POSITION	.....584
5.4.6.5	TARGET	.....585
5.4.6.6	COLOR	.....586
5.4.6.7	SETTINGS	.....587
5.4.7	CAMERA CONTROL	.....296
5.4.7.1	PROJECTION MODE	.....590
5.4.7.2	VIEW POINT	.....591
5.4.7.3	TARGET	.....592
5.4.7.4	SETTINGS	.....594
5.4.7.5	LENS SHIFT	.....594
5.4.7.6	BACKGROUND COLOR	.....596
5.4.8	OUTPUT CONTROL	.....296
5.4.8.1	MATRIX	.....598

5.4.8.2	OBJECT	.....599
5.4.8.3	VIEW POINT	.....600
5.4.8.4	TARGET	.....601
5.4.8.5	SETTINGS	.....601
5.4.8.6	LENS SHIFT	.....602
5.4.8.7	BACKGROUND COLOR	.....602
5.4.8.8	KEYSTONE	.....603
5.4.8.9	SOFTEDGE	.....604
5.4.8.10	RENDER STATE	.....606
5.4.8.11	FX	.....607
5.4.9	DMX DEVICES	.....296
5.4.9.1	BUILT-IN DMX DEVICES	.....607
5.4.9.2	CUSTOM DMX DEVICES	.....608
5.4.10	SERIAL LINK DEVICE	.....296
5.4.11	SONIC EMOTION	.....296
5.4.12	WIDGET DESIGNER DEVICE	.....296
5.4.13	BLACKLEVEL COMPENSATION	.....296
5.4.14	SPARK	.....296
5.5	EXTERNAL CONTROL (DMX,MIDI,...)	.....621
5.5.1	INPUT PROTOCOLS	.....621
5.5.1.1	DMX INPUT	.....621
5.5.1.1.1	DMX TABLES	....623
5.5.1.1.1.1	DMX TABLE PB MANAGER	..623
5.5.1.1.1.2	DMX TABLE SEQUENCE CONTROL	..623
5.5.1.1.1.3	DMX TABLE PB SERVER	..624
5.5.1.1.1.4	DMX TABLE PB PLAYER	..632
5.5.1.2	MIDI	.....637
5.5.1.3	MSC MIDI SHOW CONTROL	.....637
5.5.1.4	SERIAL LINK	.....640
5.5.1.5	SMPTE INPUT	.....640
5.5.1.6	TCP/IP	.....641
5.5.1.7	UDP - PB AUTOMATION	.....641
5.5.2	OUTPUT PROTOCOLS	.....621
5.5.2.1	DMX OUTPUT	.....642
5.5.2.2	SERIAL LINK	.....643
5.5.2.3	SPARK	.....643
5.5.2.4	SMPTE OUTPUT	.....644
5.5.2.5	TCP/IP	.....644
5.6	NETWORK & SYNCHRONIZATION	.....646
5.6.1	NETWORK SETUP	.....646
5.6.2	MASTER / CLIENT REMOTE SETUP	.....646
5.6.3	VIDEO SYNCHRONISATION	.....646
5.7	STREAMIX LIVE INPUT	.....650
5.7.1	STREAMIX DESKTOP USER INTERFACE	.....650
5.7.1.1	NETWORK CONNECTION	.....652
5.7.1.2	DESKTOP REGION	.....652
5.7.1.3	OUTPUT FORMAT	.....653
5.7.1.4	TRANSMISSION	.....654
5.7.1.5	GENERAL INFORMATION	.....654
5.7.2	STREAMIX LIVE INPUT SETTINGS	.....650
<b>6</b>	<b>FACTORY RESET TOOL</b>	<b>.....657</b>
<b>7</b>	<b>HARDWARE AND ACCESSORIES</b>	<b>.....659</b>
7.1	LCD MENU	.....659
7.2	DVI AND SDI PROCESSOR	.....662
7.2.1	DVI AND SDI PROCESSOR HARDWARE	.....662
7.2.2	SOFTWARE - QUAD SETUP MENU	.....662
7.2.3	SOFTWARE - CREATE NEW TIMING	.....662
7.3	GRAPHICS CARD SETTINGS	.....675

7.3.1	CHANGING THE RESOLUTION	.....675
7.3.2	MULTIPLE DISPLAYS	.....675
7.3.3	SETTING UP FRAME LOCK	.....675
7.3.4	GRAPHICS DRIVER	.....675
7.3.5	ATI CARDS	.....675
7.4	INPUT CARD SETTINGS	.....692
7.4.1	DATAPATH VISION RGB PRO (VGA) - discontinued	.....692
7.4.2	WINNOV VIDEUM 4400 VO / XPRESS (Composite)	.....692
7.4.3	DECKLINK SD SDI VIDEO CAPTURE CARD	.....692
7.4.4	COOLUX SD SDI CAPTURE CARD	.....692
7.4.5	COOLUX HD SDI CAPTURE CARD	.....692
7.4.6	COOLUX DUAL DVI CAPTURE CARD	.....692
7.5	CONTROLLER BOARDS	.....708
7.5.1	JOG SHUTTLE CONTROL	.....708
7.5.2	FADER EXTENSION	.....708
7.5.3	JOG SHUTTLE CONTROL (DISCONTINUED)	.....708
7.5.4	PLAYBACK EXTENSION (DISCONTINUED)	.....708
7.6	SENSOR LINK	.....716
7.6.1	TECHNICAL FEATURES	.....716
7.6.2	CONNECTING ENCODERS AND SENSORS	.....716
7.6.2.1	ANALOG INPUTS A1 AND A2	.....718
7.6.2.2	SWITCH INPUTS S1-S8	.....718
7.6.2.3	ENCODER INPUTS E1 AND E2	.....719
7.6.3	USER INTERFACE	.....716
7.6.3.1	CONFIGURATION TOOL AND WIDGET DESIGNER PRO	.....721
7.6.3.2	STAND-ALONE SOFTWARE	.....723
7.7	SERIAL LINK	.....729
7.8	SMPTE LINK	.....735
7.9	DMX LINK	.....735
7.10	DMX LINK 8	.....736
7.11	EDID LINK	.....741
7.11.1	EDID LINK HARDWARE	.....741
7.11.2	SOFTWARE - EDID LINK EDITOR	.....741
7.12	NET LINK AND CALIBRATION LINK	.....747
7.12.1	NET LINK HARDWARE	.....747
7.12.2	NET LINK BOARDS AND EXAMPLES	.....747
7.12.3	NET LINK SOFTWARE	.....747
<b>8</b>	<b>PB MENU</b>	<b>.....754</b>
<b>9</b>	<b>MATRIX PATCHER</b>	<b>.....757</b>
9.1	MATRIX PATCHER USER INTERFACE	.....757
9.1.1	FILE MENU	.....757
9.1.2	EDIT MENU	.....757
9.1.3	TOOLBAR	.....757
9.1.4	FIXTURE LIBRARY	.....757
9.1.5	FIXTURE NAVIGATION TOOLS	.....757
9.1.6	FIXTURE PATCH	.....757
9.1.7	PATCH SETTINGS	.....757
9.2	FIXTURE EDITOR	.....764
9.2.1	FILE MENU	.....764
9.2.2	FIXTURE LIBRARY	.....764
9.2.3	FIXTURE CHANNEL ID	.....764
9.2.4	FIXTURE WORKSPACE	.....764
9.2.5	HOW TO CREATE AND EDIT FIXTURES	.....764
9.3	PATCHING GUIDE	.....770
9.4	REMAPPING GUIDE	.....776
<b>10</b>	<b>WARPER</b>	<b>.....780</b>
10.1	GENERAL 3D MODELING TERMS	.....782
10.2	WARPER USER INTERFACE	.....788



10.2.1	MENU BAR	.....788
10.2.1.1	FILE MENU	.....789
10.2.1.2	EDIT MENU	.....794
10.2.1.3	MESH SELECTION	.....801
10.2.1.4	[?]-BUTTON	.....801
10.2.1.5	CAMERA SELECTION	.....801
10.2.2	TOOLS BAR	.....788
10.2.3	TABS	.....788
10.2.3.1	GENERAL	.....805
10.2.3.2	MESH	.....807
10.2.3.3	TEXTURE	.....808
10.2.3.4	MASK	.....810
10.2.3.5	KEYBOARD/MOUSE	.....812
10.2.3.6	PB CAMERA	.....813
10.2.3.7	CAMERA/VIEW	.....813
10.2.3.8	MARKER	.....815
10.2.3.9	LIVE WARP	.....819
10.3	WARPING GUIDE	.....821
10.3.1	GENERAL WARPING WORKFLOW	.....821
10.3.2	USING AN OBJECT IN PANDORAS BOX	.....821
10.3.3	WARPING WITH SEVERAL MESHES	.....821
10.3.4	LIVE WARPING	.....821
10.4	KEYBOARD SHORTCUTS	.....831
<b>11</b>	<b>LEICA 3D DISTO</b>	<b>.....831</b>
<b>12</b>	<b>DOME MASTER</b>	<b>.....832</b>
12.1	WHAT IS A DOME MASTER?	.....833
12.2	DOME MASTER USER INTERFACE	.....833
12.2.1	FILE	.....833
12.2.2	IMAGE	.....833
12.2.3	SETTINGS	.....833
<b>13</b>	<b>IMAGE CONVERTER</b>	<b>.....838</b>
13.1	IMAGE CONVERTER USER INTERFACE	.....839
13.1.1	FILE	.....839
13.1.2	IMAGE	.....839
13.1.3	SETTINGS	.....839
<b>14</b>	<b>SPLITTER</b>	<b>.....848</b>
14.1	SPLITTER USER INTERFACE	.....849
14.1.1	FILE MENU	.....849
14.1.2	EDIT MENU	.....849
14.1.3	TOOLBAR	.....849
14.1.4	MAIN WINDOW	.....849
14.2	SPLITTER WORKFLOW	.....854
<b>15</b>	<b>CITP DESKTOP STREAMER</b>	<b>.....856</b>
15.1	CITP DESKTOP STREAMER USER INTERFACE	.....856
15.1.1	STREAMING SETTINGS	.....856
15.1.2	PREVIEW	.....856
15.1.3	CAPTURE SETTINGS	.....856
15.2	CAPTURE POLAR SETTINGS	.....858
15.3	WYSIWYG SETTINGS	.....859
<b>16</b>	<b>VNC REMOTE</b>	<b>.....860</b>
<b>17</b>	<b>WIDGET DESIGNER</b>	<b>.....864</b>
17.1	SETUP	.....865
17.1.1	INSTALLATION AND LAUNCHING	.....865
17.1.2	IP CONFIGURATION (NETWORK SETUP)	.....865
17.2	USER INTERFACE	.....869
17.2.1	MAIN GUI PROPERTIES	.....869

17.2.2	FILE MENU	.....869
17.2.3	EDIT MENU	.....869
17.2.4	VIEW	.....869
17.2.5	PAGES	.....869
17.2.6	CREATE	.....869
17.2.7	NODES	.....869
17.2.8	KEYBOARD SHORTCUTS	.....869
17.3	CONTROLS	.....879
17.3.1	PAGE	.....879
17.3.2	BUTTONS	.....879
17.3.2.1	CUSTOM SCRIPT BUTTON	.....884
17.3.2.2	SCRIPT TIMER	.....888
17.3.2.3	MEDIA CONTROL PANEL	.....889
17.3.2.4	CUE CONTROL	.....890
17.3.2.5	IMAGE LOADER	.....891
17.3.2.6	VIDEO SNAPSHOT	.....893
17.3.2.7	ART-NET SNAPSHOT	.....896
17.3.2.8	ART-NET RECORDER	.....898
17.3.2.9	SCROLLER HORIZONTAL / VERTICAL	.....901
17.3.2.10	FLIPSWITCH HORIZONTAL / VERTICAL	.....904
17.3.3	ANALOG CLOCK	.....879
17.3.4	CUE LIST	.....879
17.3.5	DIGITAL CLOCK	.....879
17.3.6	DISPLAYS	.....879
17.3.6.1	ANGULAR DISPLAY	.....912
17.3.6.2	BAR GRAPH	.....914
17.3.6.3	DIGITAL DISPLAY	.....915
17.3.6.4	MOTION MASK	.....916
17.3.6.5	VIDEO INPUT DISPLAY	.....918
17.3.7	DROP DOWN LIST	.....879
17.3.8	EVENT VIEWER	.....879
17.3.9	FADER CONTROLS	.....879
17.3.9.1	COLOUR PICKER	.....921
17.3.9.2	ENCODER	.....922
17.3.9.3	FADER VERTICAL / HORIZONTAL	.....925
17.3.9.4	WHEEL VERTICAL / HORIZONTAL	.....928
17.3.10	IMAGE / PICTURE BOX	.....879
17.3.11	LABEL	.....879
17.3.12	LIST VIEW	.....879
17.3.13	PANEL	.....879
17.3.13.1	DRAWING CANVAS	.....935
17.3.13.2	MULTITOUCH	.....936
17.3.13.2.1	MULTITOUCH ITEM PROPERTIES	.....937
17.3.13.2.1.1	PANEL SETTINGS	.....937
17.3.13.2.1.2	DEVICE SETTINGS	.....941
17.3.13.2.1.3	PB SETTINGS	.....945
17.3.13.3	XY PANEL	.....948
17.3.14	TEXT INPUT	.....879
17.3.15	TEXTBOX	.....879
17.3.16	TIMECODE	.....879
17.3.17	VIDEO PLAYER	.....879
17.3.18	VNC PANEL	.....879
17.3.19	WEBBROWSER	.....879
17.4	NODES (WD PRO/ULT ONLY)	.....959
17.4.1	CREATING AND SETTING UP NODES	.....959
17.4.2	TUTORIAL NODES	.....959
17.4.3	SYNTAX TCP- / UDP- / SERIAL MESSAGES	.....959
17.4.4	NODE COMMANDS	.....959
17.4.5	INPUT NODES	.....959

17.4.5.1	AIRBAR	.....984
17.4.5.2	AIRSCAN	.....985
17.4.5.3	AIRSCAN MULTI-POINT	.....986
17.4.5.4	ART-NET	.....987
17.4.5.5	AUDIO (BETA)	.....988
17.4.5.6	BLACK BOX (BETA)	.....989
17.4.5.7	CALIBRATION LINK	.....989
17.4.5.8	CUSTOM SCRIPT	.....991
17.4.5.9	CAMERA POINT TRACKER	.....992
17.4.5.10	CLOCK	.....993
17.4.5.11	COLOUR PICKER	.....993
17.4.5.12	COM PORT	.....994
17.4.5.13	COM ASCII STREAM	.....995
17.4.5.14	COM QUERY STRING	.....996
17.4.5.15	COUNT DOWN	.....997
17.4.5.16	COUNTER	.....998
17.4.5.17	DMX LINK IN	.....999
17.4.5.18	DROPDOWNLIST	.....999
17.4.5.19	EMAIL	.....1000
17.4.5.20	ENCODER	.....1001
17.4.5.21	EVENTS	.....1001
17.4.5.22	EXCEL READER	.....1002
17.4.5.23	FACE TRACKING	.....1003
17.4.5.24	FADER	.....1003
17.4.5.25	GPS	.....1004
17.4.5.26	ID TAG TRACKER	.....1005
17.4.5.26.1	Required Hardware and Tracking Environment	....1006
17.4.5.26.2	Config ID Tag	....1010
17.4.5.26.3	Preview	....1012
17.4.5.26.4	Preview Settings	....1013
17.4.5.26.5	Camera Settings	....1013
17.4.5.26.6	Camera Lens Calibration	....1015
17.4.5.26.7	Camera XYZ Calibration	....1018
17.4.5.26.8	Marker Settings & Rendering	....1021
17.4.5.26.9	Global Tracking Settings	....1022
17.4.5.26.10	2D Camera Tracking Settings	....1023
17.4.5.26.11	3D Tracking Settings	....1024
17.4.5.26.12	Performance Options	....1025
17.4.5.26.13	Motion Prediction	....1025
17.4.5.26.14	MA PSN Output	....1026
17.4.5.26.15	ID Tag Settings	....1027
17.4.5.26.16	Lighting Console Settings	....1028
17.4.5.27	iPHONE REMOTE	.....1030
17.4.5.28	JOYSTICK	.....1031
17.4.5.29	KINECT	.....1032
17.4.5.30	KINESYS	.....1032
17.4.5.31	LABEL	.....1034
17.4.5.32	MEDIA CONTROL	.....1034
17.4.5.33	MIDI IN	.....1035
17.4.5.34	MIDI NOTE CATCH	.....1036
17.4.5.35	MOTION DETECTOR	.....1037
17.4.5.36	MOUSE	.....1038
17.4.5.37	MULTI-TOUCH ITEM	.....1039
17.4.5.38	MULTI-TOUCH PANEL POINT	.....1040
17.4.5.39	NET LINK - GENERIC I/O	.....1040
17.4.5.40	ODSL 30	.....1043
17.4.5.41	OSC	.....1044
17.4.5.42	PAGE	.....1045
17.4.5.43	PB DEVICE PARAMETER INPUT	.....1045

17.4.5.44	PING	.....1046
17.4.5.45	PROJECTOR CONTROL	.....1046
17.4.5.46	RANDOM	.....1048
17.4.5.47	REMOTE TOUCH	.....1049
17.4.5.48	RSS	.....1050
17.4.5.49	SENSOR LINK	.....1051
17.4.5.50	SERIAL LINK GPI	.....1053
17.4.5.51	SMS	.....1054
17.4.5.52	SPACE NAVIGATOR	.....1055
17.4.5.53	SMPTE LINK	.....1055
17.4.5.54	TEXTBOX	.....1056
17.4.5.55	TEXT READER	.....1057
17.4.5.56	TIMAX	.....1058
17.4.5.57	TCP	.....1059
17.4.5.58	TCP ASCII STREAM	.....1060
17.4.5.59	TCP QUERY STRING	.....1061
17.4.5.60	TRACKSCAN	.....1063
17.4.5.61	TRACKSCAN SERIAL LINK	.....1064
17.4.5.62	UDP	.....1065
17.4.5.63	UDP ASCII STREAM	.....1066
17.4.5.64	VALUE	.....1067
17.4.5.65	VARIABLE	.....1068
17.4.5.66	WHEEL	.....1068
17.4.5.67	WII	.....1069
17.4.5.68	XY PANEL	.....1070
17.4.6	FILTER NODES	.....959
17.4.6.1	ADD RELATIVE	.....1073
17.4.6.2	ANGLE TO POINT	.....1074
17.4.6.3	DAMPING PREDICITION	.....1075
17.4.6.4	DAMPING TIMED	.....1076
17.4.6.5	DELTA	.....1077
17.4.6.6	DYNAMIC TRIGGER	.....1078
17.4.6.7	IF	.....1079
17.4.6.8	JITTER REDUCE	.....1080
17.4.6.9	MAX	.....1081
17.4.6.10	MIN	.....1082
17.4.6.11	POLAR > RECTANGULAR	.....1083
17.4.6.12	RANGE	.....1084
17.4.6.13	RANGE ASYMMETRIC	.....1085
17.4.6.14	MATH FILTER NODES	.....1086
17.4.6.14.1	ABS	....1086
17.4.6.14.2	ACOS	....1086
17.4.6.14.3	ADD	....1087
17.4.6.14.4	ASIN	....1088
17.4.6.14.5	ATAN	....1088
17.4.6.14.6	CEILING	....1089
17.4.6.14.7	COS	....1089
17.4.6.14.8	DEGREE > RADIANS	....1090
17.4.6.14.9	DIVIDE	....1090
17.4.6.14.10	FLOOR	....1091
17.4.6.14.11	LOG	....1092
17.4.6.14.12	MODULO	....1092
17.4.6.14.13	MULTIPLY	....1093
17.4.6.14.14	PERCENT	....1094
17.4.6.14.15	POWER X^Y	....1094
17.4.6.14.16	RADIANS>DEGREE	....1095
17.4.6.14.17	ROUND	....1096
17.4.6.14.18	SIN	....1096
17.4.6.14.19	SQRT	....1097

17.4.6.14.20 SUBTRACT	....1098
17.4.6.14.21 SUM	....1098
17.4.6.14.22 TAN	....1099
17.4.6.15 TEXT FILTER NODES	.....1100
17.4.6.15.1 COMPARE TEXT	....1100
17.4.6.15.2 CONTAINS TEXT	....1101
17.4.6.15.3 DATE TO TEXT	....1102
17.4.6.15.4 LEADING ZEROS	....1103
17.4.6.15.5 REGEX TEXT	....1103
17.4.6.15.6 REGEX COMPARE	....1105
17.4.6.15.7 TEXT COMBINER	....1106
17.4.7 OUTPUT NODES	.....959
17.4.7.1 ANGULAR DISPLAY	.....1109
17.4.7.2 ART-NET	.....1110
17.4.7.3 BAR GRAPH	.....1111
17.4.7.4 COM PORT MESSAGE	.....1112
17.4.7.5 COM PORT ASCII STREAM	.....1113
17.4.7.6 DIGITAL DISPLAY	.....1114
17.4.7.7 DMX LINK OUT	.....1114
17.4.7.8 EXCEL WRITER	.....1115
17.4.7.9 FADER	.....1116
17.4.7.10 LABEL	.....1116
17.4.7.11 MIDI NOTE ON/OFF	.....1117
17.4.7.12 MIDI RAW MESSAGE	.....1118
17.4.7.13 MIDI VALUE	.....1119
17.4.7.14 MOUSE	.....1120
17.4.7.15 PAGE	.....1121
17.4.7.16 PB DEVICE CONTROL	.....1122
17.4.7.17 PB SEQUENCE CONTROL	.....1123
17.4.7.18 PB SEQUENCE SEEK	.....1124
17.4.7.19 PB TEXT	.....1125
17.4.7.20 PB TEXT UNICODE	.....1126
17.4.7.21 RELAY OUTPUT LINK	.....1126
17.4.7.22 SCRIPT	.....1129
17.4.7.23 SERIAL LINK	.....1131
17.4.7.24 TCP MESSAGE	.....1133
17.4.7.25 TCP ASCII STREAM	.....1134
17.4.7.26 TEXTBOX	.....1135
17.4.7.27 UDP MESSAGE	.....1136
17.4.7.28 UDP ASCII STREAM	.....1137
17.4.7.29 VALUE	.....1138
17.4.7.30 VARIABLE	.....1138
17.4.7.31 VIDEO PLAYER TIME	.....1139
17.4.7.32 VIDEO PLAYER VOLUME	.....1140
17.4.8 SCRIPT NODES	.....959
17.4.8.1 COM SCRIPTS	.....1141
17.4.8.2 TCP SCRIPTS	.....1142
17.4.8.3 UDP SCRIPTS	.....1143
17.4.8.4 PHIDGET IR SCRIPTS	.....1144
17.4.8.5 PHIDGET RFID SCRIPTS	.....1145
17.4.9 INTERACTION NODES	.....959
17.4.9.1 TOUCH INJECTION	.....1147
17.4.9.2 MOUSE INJECTION	.....1148
17.4.9.3 MOUSE DRAW TO CANVAS	.....1148
17.4.9.4 LAYER UV DRAW TO CANVAS	.....1150
17.5 TOOLS	.....1154
17.5.1 AIRSCAN	.....1154
17.5.1.1 HOW TO USE THE AIRSCAN?	.....1155
17.5.1.2 AIRSCAN TOOL SETUP	.....1156

17.5.1.2.1	GENERAL SETTINGS	....1157
17.5.1.2.2	INPUT POINT PROCESSING	....1157
17.5.1.2.3	CALIBRATION	....1158
17.5.1.2.4	MULTI POINT MODE	....1159
17.5.1.2.5	MOUSE CONTROL	....1160
17.5.1.2.6	POINT READ-OUT	....1161
17.5.2	KINECT	.....1154
17.5.3	CONNECTION MANAGER	.....1154
17.5.3.1	SMPTE LINK	.....1166
17.5.3.2	ART-NET	.....1167
17.5.3.3	DMX-LINK	.....1168
17.5.3.4	MIDI IN- & OUTPUT	.....1168
17.5.3.5	WD REMOTE TOUCH IN- & OUTPUT	.....1169
17.5.3.6	TUIO TRANSMITTER	.....1169
17.5.3.7	PSN MA TRACKING SERVER	.....1169
17.5.3.8	TCP CONNECTIONS	.....1170
17.5.3.9	UDP CONNECTIONS	.....1172
17.5.3.10	SERIAL COM CONNECTIONS	.....1174
17.5.4	TCP/UDP/COM CONNECTIONS	.....1154
17.5.5	ART-NET MONITOR	.....1154
17.5.6	WEB SERVER	.....1154
17.5.7	REMOTING	.....1154
17.5.7.1	TCP SERVER	.....1183
17.5.7.2	UDP LISTENER	.....1183
17.5.7.3	HTTP LISTENER	.....1183
17.5.7.4	NETWORK BROADCASTING SERVICE	.....1184
17.5.7.5	IPHONE WD REMOTE	.....1185
17.5.7.6	SERIAL INPUT	.....1187
17.5.8	EVENTS	.....1154
17.5.9	FUNCTIONS	.....1154
17.5.10	MACRO	.....1154
17.5.11	VARIABLES	.....1154
17.5.11.1	MEMBER AND SESSION VALUE LIST	.....1196
17.5.11.2	MATH EXPRESSIONS	.....1199
17.5.12	KEYBOARD INPUT	.....1154
17.5.12.1	SHORTCUT EDITOR	.....1204
17.5.12.2	JOG SHUTTLE	.....1205
17.5.12.3	58 KEYS	.....1206
17.5.12.4	84 KEYS	.....1206
17.5.12.5	128 KEYS	.....1207
17.5.12.6	LOGITECH PRESENTER R400	.....1208
17.5.13	MIDI INPUT	.....1154
17.5.13.1	MIDI NOTES EDITOR	.....1209
17.5.13.2	MIDI MESSAGE EDITOR	.....1210
17.5.13.3	AKAI APC40	.....1211
17.5.13.4	BEHRINGER BCD 2000	.....1212
17.5.13.5	BEHRINGER BCF 2000	.....1213
17.5.14	BLACKLIST	.....1154
17.5.15	EMAIL SETTINGS	.....1154
17.5.16	RSS SETTINGS	.....1154
17.5.17	SMS SETTINGS	.....1154
17.5.18	FACE TRACKER	.....1154
17.5.19	MOTION DETECTOR	.....1154
17.5.20	CAMERA POINT TRACKER	.....1154
17.5.20.1	CAMERA SETTINGS	.....1225
17.5.20.2	COLOR PROCESSING	.....1226
17.5.20.3	IMAGE PROCESSING	.....1226
17.5.20.4	POINT TRACKER	.....1228
17.5.20.5	TOUCH OUTPUT PROCESSING	.....1229

17.5.21 PHIDGETS	.....1154
17.5.21.1 INTERFACE KIT 0/16/16	.....1232
17.5.21.2 IR - RECEIVER TRANSMITTER	.....1233
17.5.21.3 RELAY INTERFACE 0/4/4	.....1234
17.5.21.4 RFID	.....1234
17.5.21.5 SERVO MOTOR ADVANCED 8	.....1235
17.5.22 PROJECTOR CALIBRATION MANAGER	.....1154
17.5.23 ADD LAYERS TO PANDORAS BOX	.....1154
17.5.24 ARRAY ALIGN LAYERS	.....1154
17.5.25 CIRCLE ALIGN LAYERS	.....1154
17.5.26 CUE GENERATOR	.....1154
17.5.27 VIDEO LOGGER	.....1154
17.5.28 DEFAULT IMAGE SETTINGS	.....1154
17.5.29 IMAGE RESOURCE MANAGER	.....1154
17.5.30 SECURITY SETTINGS	.....1154
17.5.31 LOCK INTERFACE	.....1154
17.5.32 OPTIONS ...	.....1154
17.6 SCRIPT LANGUAGE	.....1254
17.6.1 PARAMETER LIST	.....1254
17.6.2 COMMAND LIST	.....1254
17.6.3 PROGRAMMING STATEMENTS	.....1254
17.6.3.1 IF ELSE	.....1430
17.6.3.2 SELECT CASE	.....1432
17.6.3.3 FOR LOOP	.....1434
17.7 CHANGELOG	.....1435
<b>18 SDK</b>	<b>.....1532</b>
18.1 Getting Started	.....1534
18.1.1 Using Visual Basic / C#	.....1534
18.1.2 Using JavaScript	.....1534
18.1.3 Other Languages	.....1534
18.2 Examples	.....1541
18.2.1 Connect SDK to Pandoras Box	.....1541
18.2.2 Sending Parameter Values	.....1541
18.2.3 Receiving Parameter Values	.....1541
18.2.4 Error Handling	.....1541
18.3 Datatypes and Structures	.....1545
18.4 Function Reference	.....1548
<b>19 THIRD PARTY SOFTWARE</b>	<b>.....1592</b>
19.1 GMAX	.....1593
19.1.1 Software Setup	.....1593
19.1.2 Object Creation and Export Using gmax	.....1593
19.1.2.1 General Object Creation in gmax	.....1595
19.1.2.2 Object Creation and Export for PB Version 4.1	.....1599
19.1.2.3 Object Creation and Export for PB Version 4.5	.....1600
19.1.2.3.1 Export Using Flightsim Aircraft Exporter Plugin	....1601
19.1.2.3.2 Export Using the PB Exporter Script	....1603
19.1.3 Warping with gmax	.....1593
19.1.4 gmax Keyboard Shortcuts	.....1593
19.2 3ds MAX	.....1614
19.2.1 X-File Exporter for 3ds Max	.....1614
19.3 Blender	.....1616
19.3.1 Object Creation and Export Using Blender	.....1616

## 1 HAZARD WARNING

### Gefahrenhinweise:



Betreiben Sie das Gerät nur in Innenräumen und vermeiden Sie den Einfluss von Feuchtigkeit, Staub sowie Sonnen- oder andere Wärmebestrahlung. Öffnen Sie das Gerät nicht, es enthält keine durch den Anwender zu wartenden Teile. Die Steckdose muss nahe der Einrichtung angebracht und leicht zugänglich sein.

### Hazard information:



This device is to be operated indoors only and to be kept away from the influences of humidity, dust and sunshine or other radiating heat sources. Do not open the device. It does not contain any parts to be maintained by the user. The socket-outlet shall be installed near the equipment and shall be easily accessible.

### Avertissements de danger:



Installez l'appareil dans un endroit à l'abri de la chaleur, de l'humidité et de la poussière. N'exposez pas l'appareil directement aux rayons solaires ou à des sources de chaleur telles que radiateurs, fours, etc. Ne pas ouvrir l'appareil, il contient aucun composant à maintenir par l'utilisateur.

Le socle de prise de courant doit être installé à proximité du matériel et doit être aisément accessible.



Vorsicht! Explosionsgefahr bei unsachgemäßem Austausch der Batterie. Batterie nicht ins Feuer werfen!



Caution! Danger of explosion if battery is replaced improperly. Do not throw the battery pack in the fire!



Attention! Il existe un risque d'explosion si la pile n'est pas correctement remplacée. Remplacez la pile uniquement par une pile identique. Ne pas jeter les piles au feu.



Verbrauchte Batterien gehören nicht in den Hausmüll! Entsorgen Sie diese in Ihrer örtlichen Batteriesammelstelle!



Used batteries are not to be disposed of with the house-hold waste! Please dispose them at your local battery collection point!



Ne pas jeter les piles aux ordures menagères (loi relative aux piles et accu). Veuillez rapporter vos piles usagées dans un centre de collecte agréé.



### Entsorgungshinweis:

Gerät nicht im Hausmüll entsorgen! Elektronische Geräte sind entsprechend der Richtlinie für Elektro- und Elektronik-Altgeräte über die örtlichen Sammelstellen für Elektronik-Altgeräte zu entsorgen.



### Instructions for disposal:

Do not dispose off the device as part of household garbage! Electronic devices are to be disposed of in accordance with the guidelines concerning electrical and electronic devices via the local collecting point for old electronic devices.



### Instruction pour l' élimination des déchets:

Ne jetez pas l'appareil en fin de vie avec les ordures ménagères, mais déposez-le à un endroit prévu à cet effet par les pouvoirs publics pour son recyclage.



## 2 CONFORMITY AND ELECTRICAL INFORMATION

### Electrical Information

AC Input:  
 100VAC / 240VAC  
 12 / 6A (max.)  
 50/60Hz

Warning! This is a class A device. Operation of this equipment in a residential area is likely to cause harmful interference in which case the user will be required to correct the interference at his own expense.

Please see below the declarations of conformity and compliance statements for Player and Server hardware. Please contact the [support team](#) if you need documents for other hardware e.g. the SMPTE Link, NET Link, software dongles, or if you need them in German or another language.

### Pandoras Box Server Conformity

The Pandoras Box Server devices (including the models Server Dual, Server Quad and Server Broadcast; hardware revision 2) are ETL and CE certified. The devices comply with FCC Rules and Regulations as Part 15 devices, as well as Industry Canada standard ICES-003.

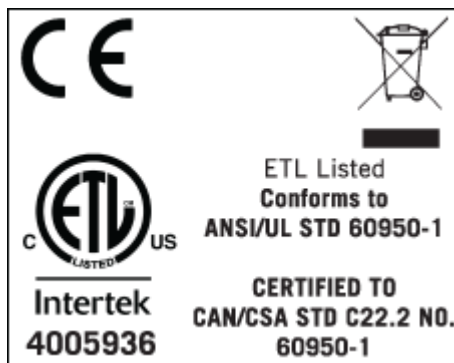

### FCC and ICES-003 compliance statement

FCC, part 15, Class A verification:

This equipment has been tested and found to comply with the limits for a class A digital device, pursuant to part 15 of the FCC rules. These limits are designed to provide reasonable protection against harmful interference when the equipment is operated in a commercial environment. This equipment generates, uses, and can radiate radio frequency energy and, if not installed and used in accordance with the instruction manual, may cause harmful interference to radio communications. Operation of these equipment in a residential area is likely to cause harmful interference in which case the user will be required to correct the interference at his own expense.

coolux GmbH  
Richard-Byrd-Str. 19  
50829 Köln / Germany



tel +49 221 995 12 0  
fax +49 221 995 12 222  
mail@coolux.de  
www.coolux.de

**Declaration of conformity** (according to EN ISO/IEC 17050-1:2010)

We, manufacturer

coolux GmbH  
Richard-Byrd-Str. 19  
50829 Köln  
Deutschland

Declare under our sole responsibility, that the product including options and accessories

Product: *Pandoras Box Server*  
Articles: *Dual Server LT/ STD/ PRO, Quad Server LT/ STD/ PRO,  
Broadcast Dual Server LT/ STD/ PRO, Broadcast Quad Server LT/ STD/ PRO*  
Manufacturer: *coolux GmbH*

to which this declaration relates, is in conformity with the following standards and directives

2014/35/EU *Low Voltage Directive*  
2014/30/EU *EMC Directive*

EN 60950-1:2006+A11+A1+A12+A2  
EN 55022:2010  
EN 55024:2010  
EN 61000-3-2:2006 +A1:2009 +A2:2009  
EN 61000-3-3:2008

**RoHS Conformity**

Through internal design controls and supply chain declarations, the described product has been verified to comply with EU RoHS Directive 2011/65/EU

*This declaration certifies conformance with the above mentioned directives. Affirmation of attributes in a legal sense is not included.*

Köln, 14.04.2016  
\_\_\_\_\_  
City und Date

 **COOLUX GmbH**  
Richard-Byrd-Straße 19  
50829 Köln  
Tel: +49 221 995 12 0  
Fax: +49 221 995 12 222  
info@coolux.de  
www.coolux.de

Geschäftsführer: Gerry Remers  
Steuernummer: 217/5718/1248

Ust - Id Nr.: DE 230800045  
Amtsgericht Köln, HRB 51649

Bankverbindung: Kreissparkasse Köln  
BLZ 370 502 99, Konto 62129

IBAN: DE 31 3705 0299 0000 0621 29  
SWIFT - BIC: COKSDE33

---

**Pandoras Box Player Conformity**

The Pandoras Box Player devices (including the models Player Dual and Player Quad) are CE certified.



coolux GmbH  
Richard-Byrd-Str. 19  
50829 Köln / Germany



tel +49 221 995 12 0  
fax +49 221 995 12 222  
mail@coolux.de  
www.coolux.de

**Declaration of conformity** (according to EN ISO/ IEC 17050-1:2010)

We, manufacturer

coolux GmbH  
Richard-Byrd-Str. 19  
50829 Köln  
Deutschland

**Declare under our sole responsibility, that the product including options and accessories**

Product: *Pandoras Box Player / Workstation*  
Articles: *Dual Player, Quad Player, Workstation*  
Manufacturer: *coolux GmbH*

**to which this declaration relates, is in conformity with the following standards and directives**

2014/35/EU *Low Voltage Directive*  
2014/30/EU *EMC Directive*

EN 60950-1:2006+A11+A1+A12  
EN 55022:2010  
EN 55024:2010  
EN 61000-3-2:2006 +A1:2009 +A2:2009  
EN 61000-3-3:2008

**RoHS Conformity**

Through internal design controls and supply chain declarations, the described product has been verified to comply with EU RoHS Directive 2011/65/EU

*This declaration certifies conformance with the above mentioned directives. Affirmation of attributes in a legal sense is not included.*

Köln, 14.04.2016  
\_\_\_\_\_  
City und Date

 coolux GmbH  
Richard-Byrd-Str. 19  
50829 Köln  
Tel +49 221 995 12 0  
Fax +49 221 995 12 222  
info@coolux.de  
www.coolux.de

Geschäftsführer: Gery Remers  
Steuernummer: 217/5718/1248

Ust - Id Nr.: DE 230800045  
Amtsgericht Köln, HRB 51649

Bankverbindung: Kreissparkasse Köln  
BLZ 370 502 99, Konto 62129

IBAN: DE 31 3705 0299 0000 0621 29  
SWIFT - BIC: COXSDE33

### 3 WHAT'S NEW ?

[Rev 13338] - Version 5.10

#### ++ NEW PRODUCT STRUCTURE ++



Pandoras Box version 5.10 introduces a product structure with new products. In the long term these will replace old licenses and hardware but at present the license structure supports old and new licenses equally. All products purchased or upgraded after May, 2<sup>nd</sup> 2016 represent the new product structure.

For existing products nothing changes with the installation of version 5.10 at first sight. At second sight you might notice that the number of Layers or Sequences has increased.

Note that the software features of all Servers have been unified and include the Server PRO features with unlimited Audio, Graphic, Video Layers and since 5.10 unlimited Sequences. Existing Server PRO products are upgraded automatically. It is possible to upgrade a LT or STD Server.

Same applies to the software Players: The software features of the Player PRO, STD and LT have been unified and include the Player PRO features with more Audio, Graphic, Video Layers and since 5.10 multi-license Sequences. Each license unlocks an additional Sequence in the same way as the layer count is multiplied. Existing Player PRO products are upgraded automatically. It is possible to upgrade a LT or STD Player.

DUAL and QUAD Players are automatically upgraded to represent the Hardware Player features with more Layers and four Sequences. Compact Players are automatically upgraded with two Sequences. Last, the software features of all Managers have been unified and include the Manager STD features with 8 Sequences and the option to have unlimited ones. Existing STD and PRO products stay unchanged, whilst it is possible to upgrade the Manager LT.

All products have now unified software features with the exception that each product group (Server, Player, Compact Player, Software Player) is available with a different number of Output layers. The hardware is separated into the categories ULT, PRO, STD and LT.

The [Product Overview chapter](#)<sup>65</sup> includes more detailed information and an [overview table](#)<sup>66</sup> with all products and their features.

[Rev 12803] - Version 5.9

#### ++ NEW KIOSK MODE: A SIMPLIFIED USER INTERFACE ++

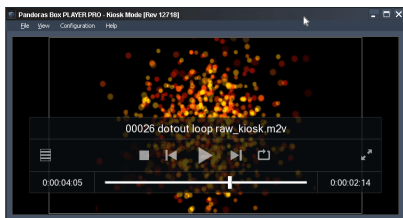

Pandoras Box version 5.9 comes with a new Kiosk Mode. The idea behind the Kiosk Mode is to offer a selection of Pandoras Box features including our playback standards within a simple, easy-to-operate interface.

When a PB Player or Server software is installed, you can start the Kiosk Mode through the Start Menu > Programs > Coolux. In the View menu you may activate "Show Playlist" to view and edit a selection of videos or images. The File menu offers the commands to load a single file, save or open existing playlists. More settings can be found in the Configuration menu: audio playback, general options or output settings. The output settings depend on the originally installed license. A Dual Server offers for example the option to set up an overlap, softedge and warping for a maximum of two outputs.

In sum, the Kiosk Mode offers an interface for user-operated installs such as nightclubs or similar.

++ MANAGER PREVIEW GOES FULLSCREEN ++



The preview in the Manager is now able to be toggled into fullscreen when previewing a Camera or Output. This is of interest for all who like to preview a site without losing pixel accuracy. The new feature also applies to so called non-local nodes, e.g. when using a Player as a master and programming on a Server client. In both cases, the coolux watermark appears in the fullscreen preview irregularly.

In addition there is an improvement when working with two (Dual View) outputs on the Master PC. In earlier versions it was only possible to render the preview on the primary output. Now, it is visible on any output! Note that it can only swap between outputs. It's not possible to see it on two outputs at the same time.

Last but not least, we made it easier to toggle Cameras and Outputs into the preview. Right-click them in the Device Tree and choose "Load in Preview".

++ REVISED PATCH TAB AND NEW PATCH TEMPLATES ++

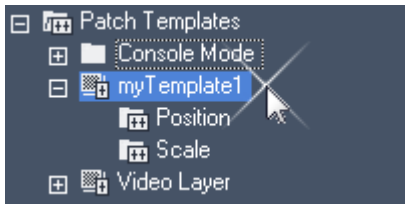

For Pandoras Box version 5.9 we revised the Patch tab completely. In addition we introduced the possibility to create, apply, export and import patch templates. This allows easier and faster workflows when patching Pandoras Box layers with DMX addresses and remote controlling them with a lighting console or the like.

In the Patch tab you decide to include a layer in the patch by ticking the check box next to it. The number to the left is the total number of patched channels in this layer. To exclude a parameter from the patch open the layer and uncheck the according check box. Note that the total patch count drops. When you have decided for all layers, you can patch them from the top to bottom with a "Start Address". Enter the start address for the site to affect all layers included in it at once.

The most used workflow is to decide once which parameters are included in a layer patch and apply this to all layers. To meet this requirement we introduced the possibility to copy and paste a patch or to create and apply patch templates. As described above, check or uncheck parameters from a layer, then right-click the layer and choose "Patch > Copy". On another layer choose "Patch > Paste". These options are available in the Patch tab as well as in the Device Tree.

Alternatively, you can choose "Patch > Create Template" on the first patched layer. In the Project tab, there is a new folder "Patch Templates" into which your templates are saved. Here, you can also edit the template, i.e. adding or removing parameters and renaming the template. To patch another layer according to the template drag it onto a layer in the Device Tree or Patch tab, alternatively right-click the template and choose to apply it to a selection of layers.

At last, you can create a folder and drag a Video Layer template into it (followed with one for the Graphic Layer, Camera Layer etc). Now you can drag the folder onto a site and all layers will patch their parameters according to the template.

You now simply assign different starting addresses for all sites and all patched parameters will have unique DMX addresses. You can do this in the Patch tab as described above, or by right-clicking a site in the Device Tree and choosing the option "Patch > Set Patch Start Values". The entire patch state (parameters and channels) can be exported as a csv file when right-clicking on a site (or layer or parameter) and choosing this option. You may want to exchange this with the lighting desk operator.

When you have created a layer template or folder with various layer templates and you like to use it again, you will find the options to export and import templates in the Project tab. Note that in a new project, you will now be able to adjust your patch without the need to work in the Patch tab itself.

++ NEW CUES TAB ++

Cues: [1] seq1					
Id	Name	Note	Type	Time	Countdown
1	Scene 1		Play	00:01:24:18	--:--:--:--
2			Pause	00:01:32:23	00:00:02:14
3	Scene 2		Play	00:01:43:12	--:--:--:--
5			Pause	00:01:49:17	--:--:--:--
4	Scene 3		Play	00:02:01:02	--:--:--:--
6			Pause	00:02:33:15	--:--:--:--
7	Scene 4		Play	00:02:55:21	--:--:--:--
8	jump back		Jump	00:03:12:13	--:--:--:--

In Pandoras Box version 5.9 you may now find a new tab, the Cues tab. It gives you a great overview of all cues in your sequence and allows fast changes. In addition, you can also export the information about cues as a csv file.

With a right-click in the title line, you can adjust which rows show according information: Cue ID, Name, [Internal] Note, Type, Time, Countdown, Jump/Wait [Time], Target [Time / Cue].

Countdown, Jump/Wait [Time], Target [Time / Cue].

When adding or editing cues in the Sequence tab, changes are displayed instantly in the Cues tab, and vice versa. To edit a cue in the Cues tab, click in the according cell, e.g. Name from Cue2, and enter your changes. You can also multi-select cues and change them at once.

When right-clicking on a cue, you can either choose to "Select Cue in Sequence" to display it in the Inspector, or you can choose to "Jump" to its position in the Sequence. Additional options are to "Add Cue at Current Time" and to export the entire cue sheet as an excel or csv file.

++ NEW TIME MONITOR TAB ++

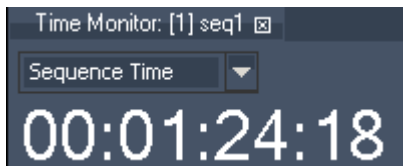

Besides the Cue tab, version 5.9 introduces the "Time Monitor" tab. You can choose to display the Sequence Time, the System Time or the Countdown for the next cue. Or you open three Time Monitors and display all time editions. Of course you can adjust the size of the new tab, or as known from previous versions, [break it out](#)<sup>290</sup> the main user interface. The new layout can be

saved to a [view](#)<sup>257</sup>.

++ NEW LAYER TYPES: PARTICLE AND TEXT LAYER ++

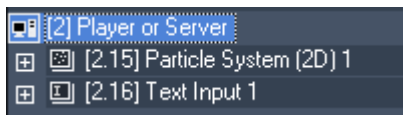

With this version we introduce new layer types for all Player and Server editions. To add a new layer type, go to the Device Tree tab, right-click on the site and choose to "Add (multiple) Device(s)" and the type.

The Particle Layer has significantly reduced layer parameters and one Particle System with a Particle Emitter already applied, hence its ready to be used.

The Text Layer is a common Video Layer which only accepts Text Assets as a media.

By the way, it is still supported to drag Particle Systems or Text Assets to a normal Video Layer. The new layer types simply provide an easier workflow or save the number of Video Layers. All new layers can be added unlimited times. So, on a system with a reduced amount of Video Layers, you can now add an unlimited number of Text Layers for example to display scrolling text.

++ ADJUSTABLE LINE HEIGHT FOR LAYERS IN SEQUENCE ++

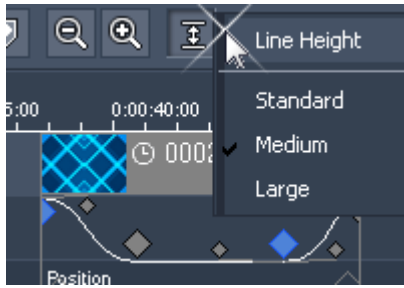

In the [Sequence tab](#)<sup>260</sup> you can now adjust the line height of a shown layer or device. At the end of the [button bar](#)<sup>261</sup>, there is a "Line Height" button that lets you choose between Standard, Medium and Large. For medium or large line heights parameter keys can not only be dragged to the left or right, which changes their time, but also up and down, which changes their value. To do this, hold the Shift key down whilst dragging the key. In addition to that small feature, keys from the "Bezier" type show their Bezier handles when being selected. Again, you can drag them in the sequence directly.

In the [Sequence section](#)<sup>144</sup> from the [Configuration tab](#)<sup>139</sup>, there is an initial value for the Line Height.

++ ADDED CONFIGURATION OPTIONS ++

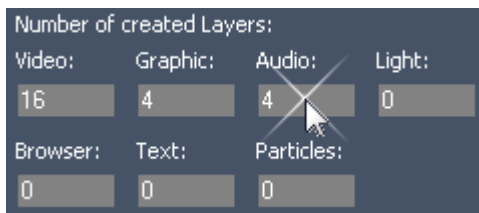

In the [Configuration tab](#)<sup>139</sup>, there are various new options. One of the most important ones is to enter the number of "Created layers" per site. This describes how many layers exist initially when creating a new site in the [Device Tree](#)<sup>168</sup>. From the number of existing layers you can choose which ones to show and which ones to hide. So to provide a faster workflow, you can now adjust the number of

existing and shown layers separately.

In addition, it is a recommended method to reduce the number of existing layers to save time and disk space when saving a project, especially when working with a big amount of Players or Servers.

++ ADDED HARDWARE SUPPORT: 3D MOUSE INPUT ++

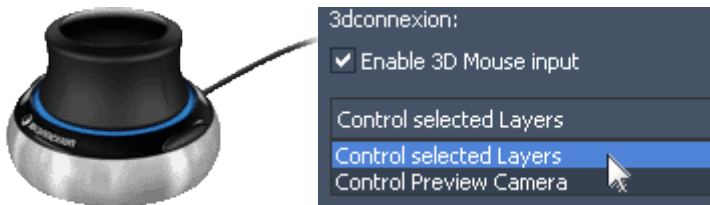

Any Pandoras Box master versions now support the product [SpaceNavigator](#) from 3Dconnexion. In short, this is a mouse device that allows to navigate in three axes (position and rotation).

After installing the driver, go to the [Configuration tab](#)<sup>139</sup> > 3D hardware and enable the new mouse input. Now you have the choice to either control selected layer(s) with it, or to control the camera selected in the [Preview tab](#)<sup>232</sup>. Note that the mouse input alters the parameters relatively, not absolutely.



++ NEW PARAMETERS ON OUTPUT LAYER: BLEND MEDIA AND PIXEL WARP ++



For the Output layer, there are two new parameters. The first one is the "Blend Media" and allows for custom softedge. Drag any image format that describes your softedge preferences, e.g. a softedge following a curve. Preferably the image is black and white as it is multiplied to the entire image from the Output. Note that all other Softedge parameters have no effect when using the Blend media! With the "Warped" check box, you can decide whether the blend media should be affected by keystone adjustments or the warp mesh that is applied to the Output or not. "Blend Media" is available on all Server and Player editions, excluding the Player LT.

The second new parameter "Pixel Warp" is for internal use and will be described in the future.

[Rev 12383] - Version 5.7

++ NEW VIDEO FORMAT SUPPORT: HAP CODEC ++

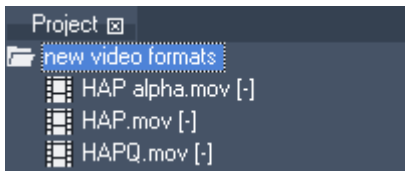

Pandoras Box version 5.7 now supports three additional formats of the Hap codec family: Hap, Hap alpha and Hap Q. Technically, these formats are comparable to the DDS snappy image sequence formats: DDS, DDSA and DDS with YCoCg. This is in regards to image quality, file size and playback performance as well as to the necessity that the width and

height of the video is divisible by 4.

++ ADDITIONAL CODEC INFORMATION IN FILE INSPECTOR ++

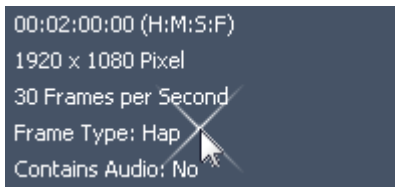

With the support of the Hap codec, we also introduced a small new feature for the [File Inspector](#)<sup>190</sup>. When clicking on a \*.mov file in the [Project tab](#)<sup>248</sup>, the Inspector now displays additional information regarding the codec included in the mov container. When using the Hap codec, the inspector shows that the "Frame Type" is "Hap" in that case. The Frame Type can only be displayed, when the codec is supported natively by Pandoras Box, i.e. is not loaded via the Quicktime Extension which also consumes more performance.

The native support of mov codecs includes now the Hap family as well as the [coolux codec](#)<sup>115</sup> of course.

Regarding the coolux codec, you can either render a mov file or an image sequence. In both cases, clicking on the \*.mov file or the image sequence file, the Inspector displays the current file format, e.g. "BMP with alpha" or "DDS (in snappy)".

++ NEW LOOP OPTION IN CLIP INSPECTOR ++

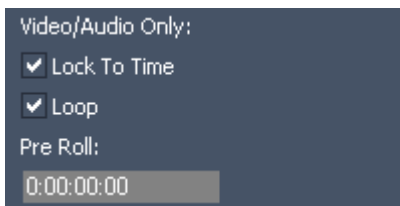

Imagine, you have a video on the timeline and after playing it back you like to keep the last frame as a still image on the screen.

First, you change the length of the container in the sequence, then you select the container and look in the [Inspector](#)<sup>202</sup>. You will find a new check box called "Loop". Per default this option is on, resulting in a looping video when the length of a container is longer than the clip itself. When deactivating the "Loop" option, the last frame is hold.

[Rev 11903] - Version 5.7

++ SYNCHRONIZED AND 4K LIVE INPUT ++

Current Pandoras Box Server hardware can be customized with DVI or SDI input cards. For the SDI input cards this revision offers the possibility to synchronize genlocked input feeds with the same resolution and framerate. This is of interest for a "mask-and-fill" setup or for creating a larger format like a 4K texture. For a Dual SDI card, you can synchronize both feeds from the same card. For a QUAD SDI card, you can synchronize two pairs (the first two and the last two) and for the QUAD 3G SDI card, you can in addition synchronize all four inputs.

To synchronize two or four inputs: Pandoras Box Master > [Assets tab](#)<sup>137</sup> > choose the Client with the card and open its "Live Input" folder. Drag all feeds into the [Project tab](#)<sup>248</sup>, select them there and make a right-click to choose to synchronize them.

To create a 4K input texture: Pandoras Box Master > [Assets tab](#)<sup>137</sup> > choose the Client with the card and open its "Live Input" folder. Drag only the first feed into the [Project tab](#)<sup>248</sup>, and there, right-click it to choose to toggle into 4K mode.

Note: The icon of the Live Input in the Project tab will change if the synchronized or 4K mode is activated.

Important: The coolux [input card driver installer](#) includes a new version 5.16. 5.16 is only mandatory when you like to use the new SDI input features. There is no need to update, when you like to use the SDI inputs the way you used to.

Very important: Please do not update yet when you use DVI inputs. Currently there is an issue with Dual Link signals!

++ MORE FLEXIBLE VIRTUAL SITES ++

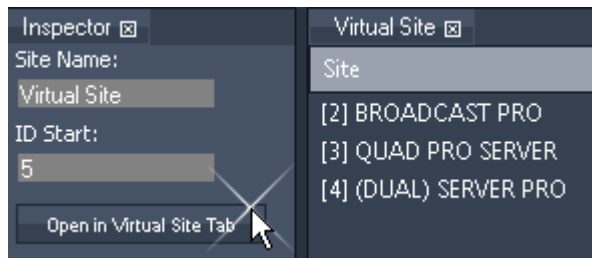

[Virtual Sites](#)<sup>286</sup> combine several Clients to one Site to fasten the programming workflow. This greatly used feature is now more flexible, as it is possible to create a Virtual Site of unlike Clients. For example, you can now sum up a QUAD Server and a DUAL Server, as long as both are PRO or STD or LT editions, meaning that the different number of cameras or output

does not matter any more.

[Rev 10386] - Version 5.7

++ NEW QUICKTIME COMPONENT / COOLUX CODEC ++

coolux has developed a codec for use on PC and Mac. With this codec, content artists can directly produce image sequences for Pandoras Box without any further transcoding step. Keep in mind that image sequence playback is mainly aimed for SSD based systems. Pandoras Box is able to playback uncompressed image sequences. So if the sequence was rendered in an according lossless file format, you can play it back without any quality loss as Pandoras Box never compresses files internally!

More information about the [coolux codec in general](#)<sup>115</sup> and the [codec settings](#)<sup>117</sup> in detail (including the description about the Quicktime Converter).

++ NEW IMAGE (DE-)COMPRESSION: SNAPPY FORMAT ++

With this revision we now support a new format for images and [image sequences](#)<sup>99</sup>: .snp files. The tools [Dome Master](#)<sup>832</sup>, [Splitter](#)<sup>848</sup>, [Image Converter](#)<sup>838</sup> and the new [Quicktime Converter](#)<sup>117</sup> offer to

save images using the snappy format. Pandoras Box itself can playback the format.

To be accurate, the snappy format is actually not an image format itself but a compression library offered from Google. So if you have a .jpg, .png, .bmp or .dds image, snappy compresses the file size but keeps the available quality as it simply reduces the file data. If you work with .snp files, the saving or reading process does not need more time, as the (de-)compression works in highspeed and real-time. In other words, Pandoras Box can decompress snappy image sequences on the fly. The result is a much smaller file size whereas the size difference depends on redundancy in your visual content, such as alpha channels or same colors in motion graphics. This way you gain a lot more drive space which is especially interesting for SSD systems as their drives normally offer less space.

++ NEW TOOL: THE QUICKTIME CONVERTER ++

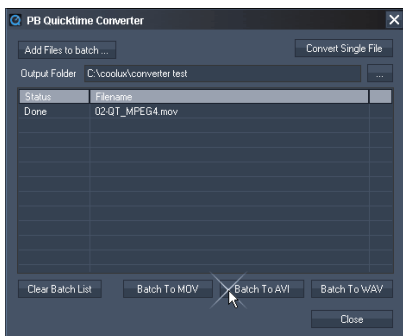

Naturally, it is not recommended to playback .mov files with Pandoras Box due to several reasons, e.g. synchronization. The [Quicktime Converter](#)<sup>117</sup> enables you to convert .mov files, for instance if the content has been rendered and delivered in that format and there is no time to render it again.

You may find the Converter along with all other coolux tools (Warper; Matrix Patcher,...) in the "Tools" menu.

Choose "Convert Single File" or, in case you have multiple files, "Add Files to batch" and select the original .mov file(s). The

Converter requires an installed Quicktime Player. Keep in mind that .mov is a container format not a codec itself. Thus, the container can contain any common or uncommon codec. To convert a .mov, the codec used in it, must be installed on the PB system as well.

As a next step, choose the format into which the file(s) should be converted. For instance, you may choose the .avi format or to render an image sequence.

++ COLORIZABLE LAYERS ++

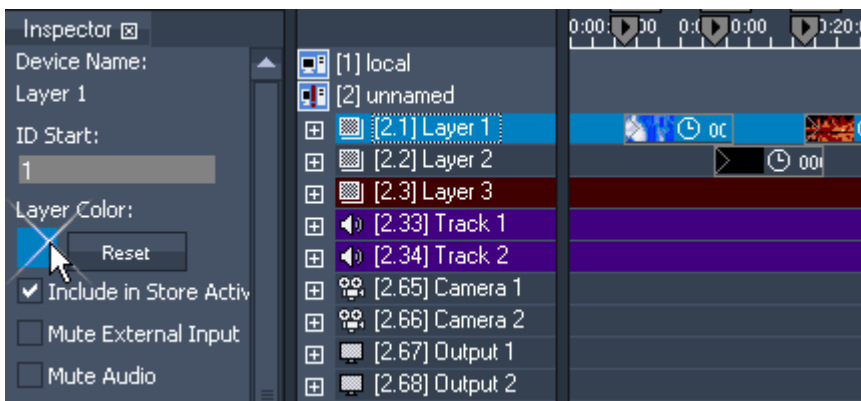

The new Pandoras Box version offers the possibility to colorize layers and other devices. The color is seen in these tabs:  
 - [Device Tree](#)<sup>168</sup>  
 - [Sequence](#)<sup>260</sup>  
 - [Device Viewer](#)<sup>182</sup>

Simply select a single or multiple devices (i.e. Video Layers, Cameras,

etc) to open the [Video and Graphic Layer Inspector](#)<sup>208</sup>. There you click on the color field and choose any new color. The button "Reset" applies the default color again.

++ PANDORAS BOX SUPPORTS KINET ++

With this version we introduce the support of a protocol called KiNET. KiNET is a lightweight UDP/IP based protocol used to communicate via Ethernet with Philips Color Kinetics light fixtures and power supplies. The KiNET settings are available in the [Matrix Patcher](#)<sup>757</sup> only.

++ NEW SHORTCUTS ++

The following shortcuts have been added or changed:

- CTRL + F: enters or leaves the fullscreen mode
- CTRL + A: selects all entries in a [playlist](#)<sup>229</sup>
- CTRL + T: calls the [Assets tab](#)<sup>137</sup>

See here all [keyboard shortcuts for a Master system](#)<sup>292</sup> and for a [Client system](#)<sup>295</sup>.

++ VERSION 4 PROJECT CONVERSION ++

There is a considerably improved import / conversion of older Pandoras Box projects saved under version 4.

Before, the entire timeline was missing. Now, all sites and devices, as well as cues, containers and other timeline settings are converted. Please note that still there are elements that are not possible to be imported:

- Layer Effects (version 5 introduced the [Aeon FX engine](#)<sup>136</sup>)
- some [Layer Parameters](#)<sup>298</sup> (e.g. Rotation) as version 5 offers two parameters for constant and continuous rotation, instead of one
- [Presets](#)<sup>253</sup> in general as version 5.1 introduced a new type of sequence presets not based on active values
- [DMX patches](#)<sup>623</sup> as version 5 offers new FX and other parameters

Depending on your project, there might be further attributes. Please check and edit the converted project thoroughly to make sure it works as you expect.

++ BLEND MODES AVAILABLE ON PLAYER ++

Until this version, the Blend Mode parameter was only available on Servers. It is used to determine how two layers are blended into each other. The default called "Normal" simply hides the lower layer with whatever is present in the top layer. With other modes you can for instance "add" the top layer's pixels to the ones from the lower layer, or set up a Mask and Fill combination.

All Player version have now the included this Blend Mode. More information about [Blend Modes](#)<sup>315</sup>...

++ NEW HELP ICONS IN THE USER INTERFACE ++

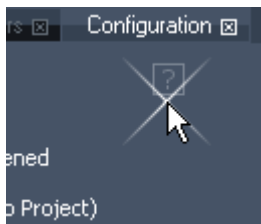

The sub sections in the Configuration tab now contain a small question mark icon. When you click it, the manual opens and displays the according information for this configuration section. So, if you wonder what a specific check box or option does, simply click the help icon next to it.

[Rev 10045] - Version 5.7

Please find below descriptions for the most important features and new hardware devices. Not mentioned are minor settings as this version comes with an exceptional amount of small but helpful changes. Most of the new options and settings can be found in the Inspector of each item and in the right-click menus. For additional information, see the changelog (e.g. C:\Program Files (x86)\coolux\Pandoras Box... Rev 9929)

++ VENUE SITES: The new way of previewing content by rendering it directly on your digital 3D stage +  
+



Undoubtedly the coolest feature in version 5.7: Venue Sites. In difference to normal sites a Venue Site is never a real Player or Server. The purpose of a Venue Site is to render your programming (of real sites) on 3D objects that form a virtual copy of your stage. That turns the Preview tab from being an abstract image to a very real representation of what is happening on stage.

Regarding real clients, you include them into the sequence by dragging them from the [Assets tab](#)<sup>137</sup> or from the [Device Types tab](#)<sup>181</sup> into the [Devices tab](#)<sup>168</sup>. You render content on them by spreading media files to it and assigning these resources to layers. With respective settings (opacity, scaling, effects) the resources appear in the 3D space of Pandoras Box. Whenever a Camera Device sees a resource, it renders it as part of its camera texture. Then this texture is send to the Output Device to be re-rendered with the output settings (warping, keystone, softedge). This texture is the real output of your graphics card and is connected to a display device.

Regarding Venue Sites, you include them into the sequence by dragging them from the [Device Types tab](#)<sup>181</sup> into the [Devices tab](#)<sup>168</sup>. You render content on them by routing textures to it and assigning these textures to Venue Layers. A valid texture is either a camera or output texture from a real site. It can be a real media file too. Mind, that the site needs to be toggled into the preview. Besides the texture, you would mostly apply a 3D object to a Virtual Layer too. The object represents a part of your stage. This can be for instance a flat 2D object representing a display, or it can be a curved object representing a curved projection screen, or it can be a chair object, moving head object, human object. From that point on, the render pass is the same as above. The Venue Layer is captured by a Venue Camera which sends its own texture to the Venue Output, again offering the known output settings. But the Venue Output does not send its result to a real display but to the Preview tab.

You may also preview a Venue Camera and animate it on the timeline. This way you can fly through your 3D stage and look at the content from different angles. Of course you can always export this animation using the [Video Export feature](#)<sup>281</sup>.

As with other sites, all settings for Venue Sites can be kept as [active values](#)<sup>135</sup> or be [stored to the timeline](#)<sup>264</sup> in form of containers. Or you remote control them using for instance the [Widget Designer](#)<sup>864</sup>.

There is the possibility to (roughly) simulate projectors including the deformation when hitting screens. That is what makes keystoneing and warping necessary. Softedging can be roughly simulated too.

First, add a [light layer](#)<sup>582</sup> to your Venue Site. The light represents the projector. The light controls like position stand for the projector's position and the field of view, represents the lens FOV. The projector's image is of course a texture from another site. Now you need another Venue Layer with a 3D object that represents the real screen. Apply a [light effect](#)<sup>484</sup> to the layer to "receive" the projector's light.

A sample project can be found in C:\coolux\content\projects\VenueSites\_Training\_Stage

++ ADDING MULTIPLE CAMERAS AND ENHANCED CAMERA FEATURES ++

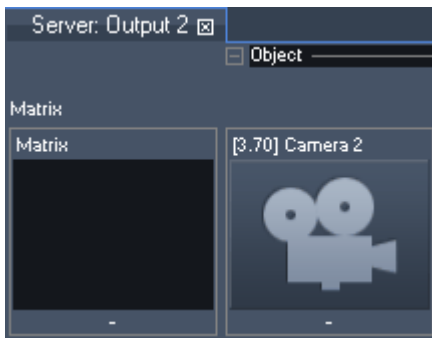

It is now possible to add multiple cameras to your Server site and connect them individually to the output. The number of outputs is still determined by your product, e.g. two per Dual Server license.

Up until today, there was a fixed pair: one camera per single output. Whatever was seen by this camera was automatically routed to the [Output Device](#)<sup>597</sup> as the "camera texture". Now you may choose to add another [Camera Device](#)<sup>589</sup> per right-click onto the respective site (Server). Regarding the routing, you may decide what camera sends its image to the Output Device. The Device Controls tab offers a new field, right-click

into it and choose your camera. Similar to assigning different images to a graphic layer, you may store the different camera textures as [containers to the timeline](#)<sup>264</sup>.

Find new individual settings including the size of the camera texture in the [Camera Inspector](#)<sup>214</sup>. This allows for higher (or lower) resolution for rendering the individual passes which helps in many applications: First Pass Anti alias, Flexible texture mapping, [Video Export](#)<sup>281</sup>,...

The navigation in the preview tab developed to be more direct which makes the orientation in preview tab easier and more efficient. First of all, you may now choose to preview a camera just as you used to do with an output (right-click in Preview tab > [Select Preview](#)<sup>237</sup>). Then the chosen camera view can be navigated similar to the [global preview](#)<sup>237</sup>. It is a great time saver that the navigation changes reflect as active values for the controls of the Camera Device. By storing these to the timeline, you can create great camera fly-through animations in a glimpse of an eye. Another option is to create accurate views, e.g. top view, site view, isometric view, particular video export view etc.

++ REDESIGNED PREVIEW ++

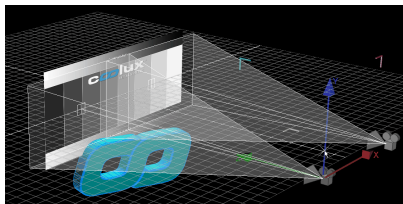

The new [Preview tab](#)<sup>232</sup> renders [camera wireframes](#)<sup>238</sup> with improved design. Per default they are now more plastic and overlapping cameras / outputs can be identified easier. You may adjust the camera's wireframes in the [camera Inspector](#)<sup>214</sup>, e.g. set the color and transparency for individual cameras.

Secondly, the rendering from 3D objects has been reformed: object default color, grid appearance and a default light source can be set up to meet your needs. Last but not least the new preview puts forward with an adjustable grid marking the XZ-plane to make it easier to orient in 3D space. Find these settings in the Configuration tab > [Preview Display](#)<sup>151</sup> (also accessible through the right-click menu of the Preview tab).

++ TEXT INPUT OFFERS NEW OPTIONS AND DESIGN ++

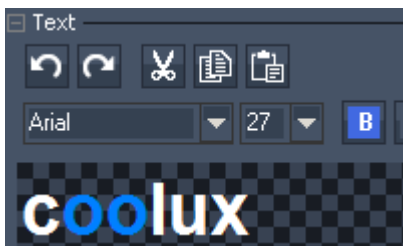

This version comes with a completely re-designed [text editor](#)<sup>277</sup>. The Text Input Resource now offers enhanced formatting options including the possibility to assign different font styles withing the same resource. There is also an automatic horizontal and / or vertical scrolling and offset option. In addition, it is possible to have an unlimited amount of text or to use a continuous text input.

Create a text input as usual (right-click in the Project tab > Add Text Input), the Inspector tab now offers new options and the button "Open in Resource Editor". There you may find the full scope of

possibilities.

You may need .net 4 installed for using the new text input plugin.

++ AUDIO INPUT, AUDIO RECORDING, AUDIO ROUTING ++

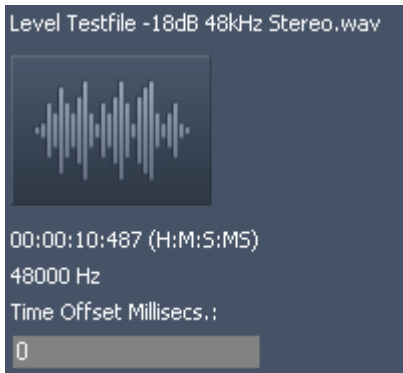

The latest Pandoras Box audio feature development makes it possible to input ASIO sound as well as HD-SDI embedded audio, opening up a whole new world of real-time media compositing.

You may input ASIO sound and route it to any ASIO output by assigning the input to the according ASIO track. This means that audio inputs can be arranged on any Pandoras Box timeline, or can alternatively be triggered via external commands.

Audio delay settings are available per Resource, Layer or on Clip Level. That enables you to set up different delays for different

output signal chains.

Next to the feature to input, route and delay audio inputs, it is possible to record ASIO inputs via the [Video Recording tab](#)<sup>284</sup>.

++ NEW HARDWARE: COMPACT PLAYER AND COMPACT STATION ++



The Compact Player is a 9.5" wide and 1.5 rack units high. It is a i5 hardware running a Win7 operating system. It is equipped with a 120 GB SSD hard drive and an NVIDIA graphics card (GT640 GPU 1Gb dedicated RAM). The systems RAM is 2GB.

The Compact Player comes with an included Compact Player license (no sequence, 2 Video Layers, unlimited Graphic Layers, 1 Output).

The Compact Station can be combined with any other additional license, e.g a Manager, Player (multi-license), Widget Designer...

The allowed playback performance is 2 x 1920x1080 for MPEG2 or DDS image sequence.

Regarding audio support, the Compact Player license has no included ASIO Tracks as other licenses do. Eventhough the hardware does not nativly support ASIO, to install the ASIO4ALL driver is possible. When using this driver, coolux cannot guarantee synchronization. Audio playback on Video Layer (with MP3, WMA, WAV format and embedded sound) is supported.

The connections in the back and front:

- 1x DVI Out (DVI-D Single Link and Dual Link, DVI-A)
- 1x HDMI Out (incl. Audio Support)
- 1x GB Net
- 5x USB (2x USB 2.0 (black) + 3x USB 3.0 (blue))
- 1x eSATA (red)
- 1x DC Power IN, external 19V PSU
- 2x Mini Stereo Jack Out, 1x Mini Stereo Jack In, 1x Optical Toslink Out (so far not supported)
- 1x SD Card Reader

[Read more...](#)

++ NEW HARDWARE: NET LINK ++



The NET Link is a modifiable interface device build to:

- provide sensor information as input signals to [Widget Designer](#)<sup>864</sup> or the [Warper](#)<sup>780</sup> and / or
- control relays by sending output signals.

Through these programs sensors can control layer and sequence parameters in [Pandoras Box](#)<sup>94</sup>. In return, Pandoras Box can trigger the devices too.

Regarding the [hardware features](#)<sup>747</sup>, the NET Link is a customizable device and comprises:

- a housing: choose between the small chassis depicted above or the 19" rack module
- min. one processor unit
- changeable boards: coolux delivers the NET Link ready-to-use as ordered by you. However, you may modify the NET Link by changing the boards at any time. Currently, seven boards are available covering analog and digital boards as well as input and output ones. [Show examples...](#)<sup>750</sup>

The Calibration Link is a small NET Link device equipped with two analog fibre input boards for the input of 16 fibre cables (single-core, diameter of 0.98mm<sup>2</sup>). It is specially designed for an automated re-calibration of a projection setup, e.g. in a fixed installation where a projector or a screen have been moved. [Show example...](#)<sup>750</sup>

++ NEW HARDWARE: EDID LINK ++



The EDID Link is a device to manage DVI-EDIDs and communicate these to the graphics card.

It can be used to generate and constantly hold an EDID whenever a display device is not able to send a correct or the exact needed EDID to the source. In addition the EDID Link will ensure, that a monitor is simulated even when none is connected to it, or powered down. The EDID Link does not need any separate power.

Per default, the EDID Link comes with preinstalled EDIDs (i.e. a preset list) and can be used without additional software. The software addresses more advanced users and allows to read and modify EDIDs or create new ones and store them to the available preset list. [Read more about the hardware and software](#)<sup>741</sup>.



++ SEQUENCE ICON BAR (Including merge and split Clips) ++

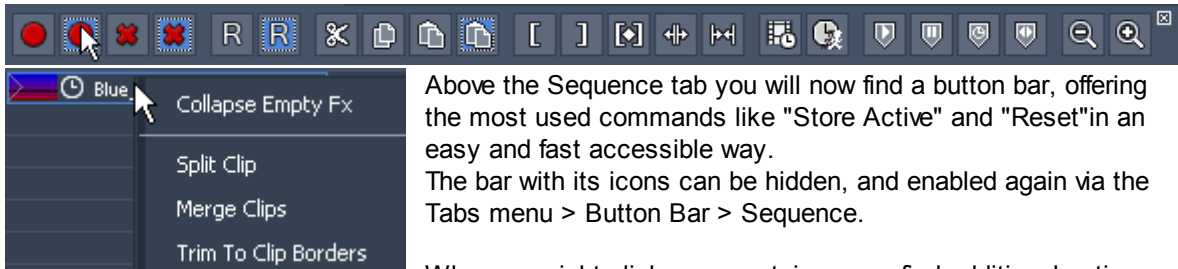

Above the Sequence tab you will now find a button bar, offering the most used commands like "Store Active" and "Reset" in an easy and fast accessible way. The bar with its icons can be hidden, and enabled again via the Tabs menu > Button Bar > Sequence.

When you right-click on a container, you find additional options in the context menu. You may split one clip at the nowpointer's position. If you have several container within the same track selected, you may merge them. If they have different options regarding Lock to time or free-run, media file, mesh file etc., the first container in time wins.

++ FULLSCREEN IS SINGLE ++

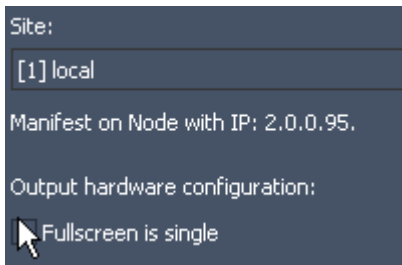

The option "fullscreen is single" has moved. It still has the same effect: ignoring a second display and forcing Pandoras Box' fullscreen onto one single display. In previous versions, it was present in the Pandoras Box client window, now it is available in Pandoras Box master interface. Open the Configuration tab > [Render Engine](#)<sup>153</sup> and select the client you like to set up. There you might also find all other options regarding the client's render engine.

++ NEW OBJECT SUPPORT: FBX, 3DS and OBJ FORMAT ++

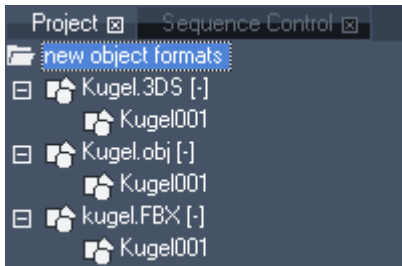

Besides the known .x format, Pandoras Box version 5.7 now supports 3 additional formats for two- and three-dimensional objects. The [Project tab](#)<sup>248</sup> accepts .fbx, .3ds and .obj files, either dragged in from the [Assets tab](#)<sup>137</sup> or any [file explorer](#)<sup>248</sup>. If your \*.fbx or \*.3ds contains subobjects (groups of objects), you may set up the hierarchy level in the automatically opened dialog. "1" results in one file in the Project tab whereas "2" results in a folder containing subfiles and so on. In that case, you may drag any hierarchy level, single file or folder onto a layer (Video Layer, Graphic Layer, Output Device, Venue Site Layer etc.).

You may adjust the global appearance of 3D files in the [Configuration tab](#)<sup>139</sup> > [Preview Display](#)<sup>151</sup> and for each file separately in the [File Inspector](#)<sup>190</sup>.

++ SPREADING ENHANCEMENTS ++

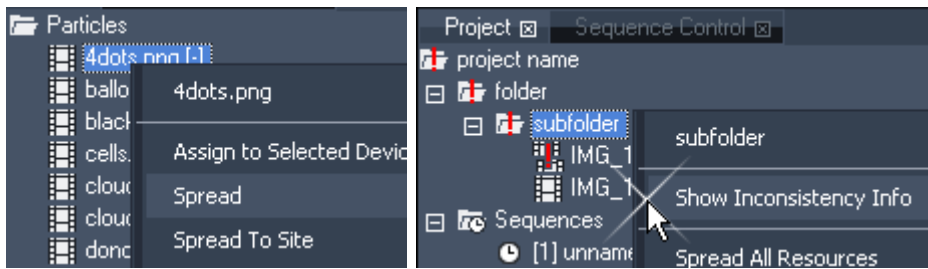

Regarding the spreading mechanism, several optimizations have been undertaken, leading to more robustness, flexibility as well

as better and safer file administration. Most importantly you will notice a new behavior indicating inconsistent files. Before, only the missing or corrupt file itself had a red exclamation icon, not the folders above. This has changed. Every folder, regardless of his hierarchy level is marked with the warning icon as soon as it includes an inconsistent file. Furthermore there is an "Inconsistency Info" dialog that helps to identify defective or missing media. To access it, right-click on any folder and select "Inconsistency Info".

++ USER DEFINED INITIAL VALUES ++

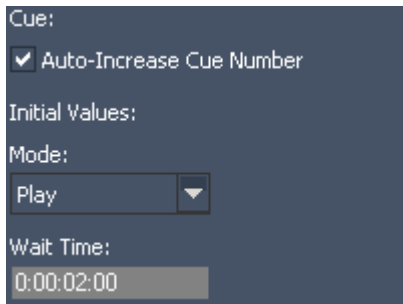

Since ever the Configuration tab amasses numerous settings influencing the overall appearance and behavior of the Pandora's Box master interface. Now it consists of many more sections and settings that allow to be user-defined and perform as initial settings. In other words, we implemented the feature to have default settings which individualizes, eases and fastens your entire workflow immensely.

Amongst many settings you may define for instance the properties of a container (Lock To Time, Preroll, Fade In, Duration) or the type for a cue or whether resources should have FluidFrame enabled per default. Each newly created container, cue or resource, is initialized with these settings.

++ EFFECTS: FX SEARCH, FX BROWSER EXPLORER, FX DOCUMENTATION, NEW FX TYPE: Creating content on the fly, no matter what resolution ++

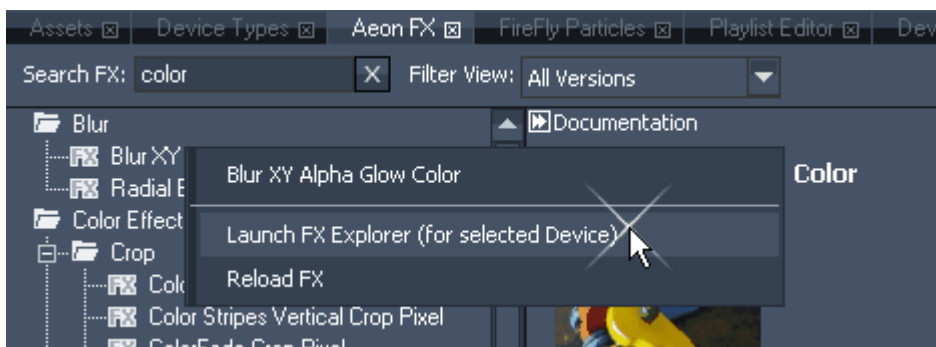

The Aeon FX tab awaits you with three improvements.

A new Search Field helps all who forgot the exact name of a particular effect or just the folder containing it. It also makes finding an unknown but suitable effect easier too. Simply start typing into the Search Field (e.g. color) and automatically it filters effects and shows only those somehow including the typed letters, e.g. Color Only, Target Color Burn, ....

Secondly, an Effect Explorer has been developed. You may find it under Tabs > Launch FX Explorer or within the right-click menu from an effect.

To the left, it shows all effects in a file tree. Select one and its description pops up in the right part. It is almost the same description as the one found in the manual: exemplary images, a short sentence what the effect does and a table listing all available parameters. At the browser's bottom you may find the controls of the currently selected layer. By clicking on an effect, it is instantly added to the controls and you may try out how the effect interacts with the layer's media file and how changing the parameters influences this. If you found the effect you were looking for, click the "Ok" button underneath the controls and the Effect Explorer will close after adding the chosen effect to the layer with its the current parameters (as active values). If you like to keep that effect but add another one on top, click the "Add Next FX" button. If you like to try another effect instead, simply select it from the file tree. When adding more effects, you may even say where an effect should be positioned, e.g. between FX3 and 4.

"Close" will discard the entire effect collection added since launching the Explorer and close the dialog itself.

Last but not least, there is a new effect type: so called generic effects allow to generate moving content in real time, without the need of pre rendering anything. In addition they are independent from the pixel resolution from your outputs as the layer with the effect can be scaled as you wish.

++ ADDITIONAL SOFTEDGE SETTINGS ++

Pandoras Box version 5.7 added a new set of softedge blending shaders to the [Aeon FX tab](#)<sup>136</sup>. The main change to the default softedge options for an Output device is that the curve parameter controls are strength and width of the curve instead of shifting it left and right. Plus, there is an additional Offset parameter that lets you control the center /white/grey point of the blend. Thirdly, there are parameters for RGB gamma corrections which might need to be applied when you want to adjust a good projector to a bad one.

++ LEICA 3D DISTO TOOL ++



The [Leica 3D Disto tool](#)<sup>831</sup> comes automatically with the installation of a Pandoras Box Manager. It is accessible in the "Tools" menu. The tool requires that the Leica hardware, specifically the 3D Disto, is connected and the drivers are installed. Please note, that the distometer cannot be purchased through your local distributor but we are happy to forward contact details.

In short, the motorized distometer measures points with great accuracy and in return can laser to any point, measured before. It draw our attention as it can be used in complex 3D scenarios to measure projector positions and object position. It reduces setup times significantly.

++ UNIT HANDLING EASES PIXEL ACCURATE WORKFLOW ++

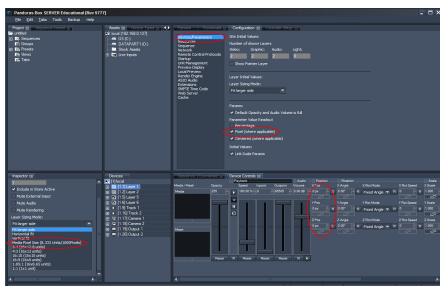

With this Pandoras Box version we included fundamental settings to allow easy adjustable, pixel accurate settings. The new section in the Configuration tab "[Unit Management](#)<sup>149</sup>" lets you setup how 3D Units relate to pixel units within one system or across multiple clients.

When the "Unit Translation Mode" is set to "Fixed relationship" you can enable in the Configuration tab section

---

"[Devices / Parameters](#)<sup>139</sup>" a Pixel Readout for Parameter Values. The Device Control tab then allows to type pixel values for parameters like Position. Furthermore, the Layer Inspector allows additional settings like "Media Pixel Size" or "1:1" for the [Layer Sizing Mode](#)<sup>208</sup> to match the main medias resolution instead of scaling it to fit in the horizontal or vertical fullscreen size.

Using this decidedly "pixel oriented workflow" makes it easy to set up and use split pictures, and also aids the communication flow between operators and content designers, who are used to thinking in terms of pixel values anyway.

[Rev 9055] - Version 5.5

++ NEW IMAGE SUPPORT: DDS FORMAT ++

Pandoras Box revision 9055 now supports a new format for images and image sequences. The dds format claims to perform better than other formats like jpg, png or bmp. In Comparison to these formats dds images save performance. In addition, always depending on the kind of content, it possible to achieve better results regarding the quality than the mpeg format can provide with videos.

The Image Converter supports the dds format as well, thus it is possible to convert images and provide them for Pandoras Box. More information about [image sequences in general](#)<sup>99</sup> and the [Image Converter](#)<sup>838</sup>.

++ NEW ASSET: CANVAS ++

There is a new media type provided by Pandoras Box and Widget Designer: a so called "Canvas". To create a Canvas in your Pandoras Box project, right-click in the Project tab and choose "Add Canvas". It can then be applied to a layer of your choice, e.g. a Graphic Layer. The Canvas consists of graphical elements that may be created in Widget Designer. It is for example possible to draw on it and create other elements on the fly. Hence, the Canvas changes the appearance dynamically and Pandoras Box renders the image interactively in real-time.

In Widget Designer (higher Rev 506) please find the "Canvas Template Manager" under "Tools". It lets you create a template which is seen in a preview window. Then you can set a background color and when right-clicking in the preview, you may add text, ellipses and rectangles.

Furthermore, there are dedicated nodes under "Create > Nodes > Interaction". They can be used to draw on an existing Canvas Asset in Pandoras Box based on the local mouse movement. To visualize these movements in Widget Designer as well, you may use the item "Drawing Canvas" under "Create > Panel".

[Rev 8499] - Version 5.5

++ CONTAINER DRAG AND CONTAINER COPY ++

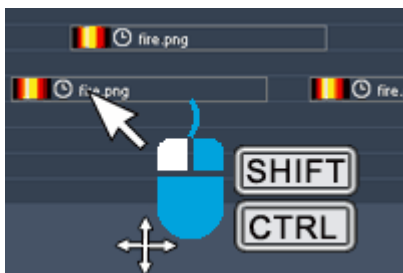

Dragging and copying containers has been improved. If you now drag a container it can be shifted to another layer as well, it is not restricted anymore to the layer were it was created. If shifting a container to another layer type, the container turns red to indicate that some keys might get lost. In addition a warning dialog pops up. This dialog can be deactivated in the [Configuration tab - Sequence](#)<sup>144</sup> by unchecking the option "Warn when clip drag would lead to change of layer type"

If you like to shift a container without moving it to another layer, hold down the SHIFT key. This locks the layer "borders".

Holding down the CTRL key whilst dragging a container activates the copying function. As soon as you let go on the same layer or on another layer you have created a copy from the original container. You might do this with multi selected containers or keys as well. More information about [programming in the sequence...](#)<sup>264</sup>

++ STORING ACTIVE VALUES ++

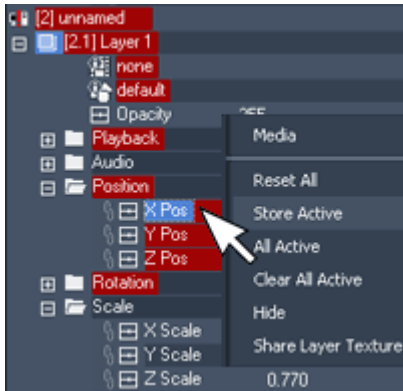

Storing active values as key frames in the timeline has been extended with more options. First of all, there is a new command "Store Active" when right-clicking in the Sequence tab's time bar. A dialog opens asking for a time where all keys should be created.

Furthermore, you may decide whether you like to store ALL active parameters or just those belonging to a certain device or parameter group. In order to store, for example just the X Position, expand all parameters in the Device Tree (e.g. using the +-symbol) and make a right-click on the parameter "X Pos" and say "Store active". If right-clicking on a level higher, in our case "Position", keys for X Pos, Y Pos and Z Pos are created if

they were all active. In the same manner active values can be stored per layer or per Server / Player / DMX device.

Last but not least, if you have an active value and then create a key by right-clicking in the timeline on the parameter track, the newly created key will adopt instantly to the value and thus deactivate the active status from the parameter.

More information about the [right-click menus in the Device Tree tab](#)<sup>172</sup>...

++ AUTOMATIC FADE IN AND OUT FOR OPACITY AND VOLUME ++

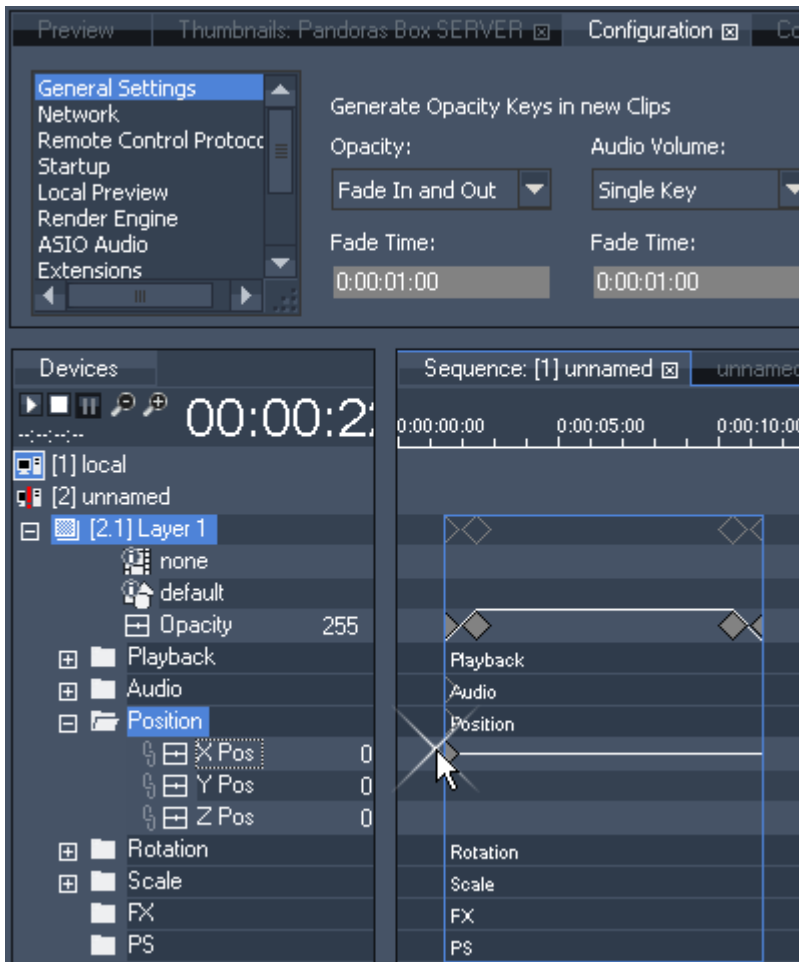

The [Configuration tab](#)<sup>144</sup> offers now the possibility to set up automatic key creation. You may choose whether there should be always keys programmed for the parameters opacity and volume as soon as a container is created. If you choose the option "single key" a key is created at the beginning of a container, the option "Fade in" creates two keys and "Fade in and Out" four keys. If choosing a fade scenario you may set up the fading times.

In the example depicted left (click to enlarge the picture), a fade in and out scenario is set up with the default time of one second. As soon as a right-click is now made in the Sequence tab, for example in the opacity track or X Pos track, a container is created holding automatically four

keys, two for the fade in and two for the fade out.

Besides, these four keys are generated as soon as an active value is stored (creating a container) or when an asset is dragged from the Project tab into the sequence.

++ PANDORAS BOX WEB BROWSER, CLICK EVENTS AND POINTER LAYER ++



Pandoras Box version 5.5 includes the feature to access internet pages and render them as so called "Browser Assets" in order to make them visible on graphic or video layers.

To create a browser asset, simply right-click in your Project tab and say "Add Browser", then assign a domain (e.g. <http://coolux.de>) and texture size within the [Browser Inspector](#)<sup>192</sup>. You may as well change the look by influencing the background color. The asset can then be assigned to a layer, just like a video or image. You may click on the left picture in the middle to enlarge the depicted GUI.

Please note that the render and loading process might take up to 15seconds depending on the texture size and web site complexity. This is also subject to the internet connection.

In addition, version 5.5 features the possibility to accept click events (click inputs) happening on the master or client system, for example when a mouse button is clicked or when an AirScan is used. The click input is then routed to the visible layer and in case it is a browser asset, it executes the underlying link. These click inputs can be single touch inputs when using Win XP or multi-touch inputs when using Windows 7 and higher.

To activate click events, select the client in the Device Tree tab and turn to its [Inspector](#)<sup>206</sup>. The button "Input Settings" opens a dialog where you can activate your output(s) of choice and the option to route the local inputs to layers.

Routing them to a [Widget Designer Device](#)<sup>609</sup> requires this device in your Device Tree and allows to monitor and work with the mouse input information in the Widget Designer. This recently introduced feature is called [Layer Picking](#)<sup>244</sup>. The chapter includes a step-by-step example and detailed information about Layer Picking.

If you like to be able to click in the rendered preview tab on your Master, simply activate the "Picking Mode" by highlighting the link symbol in the right upper side from the tab as seen in the left image at the bottom.

As a third feature we introduced "[Pointer Layers](#)<sup>581</sup>" to make the mouse pointer visible. Right-click in the Device Tree tab, choose "Add Layer > Pointer" and assign a media to it. Now, depending on the layer's opacity, this pointer layer is automatically shown:

- in the Preview tab if you are in the picking mode
- in the client's small render window
- in the client's fullscreen render window

++ PANDORAS BOX WEB SERVER ++

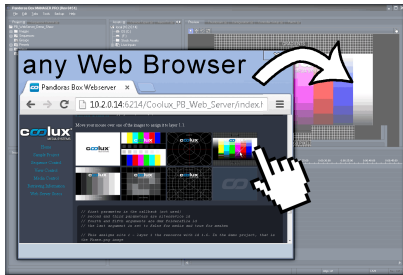

Version 5.5 comes with the newly developed Pandoras Box Web Server. It offers remote control of a Pandoras Box project that can be implemented into a web site. All PB Automation commands, known from the SDK, are now executable in [JavaScript language](#)<sup>1535</sup>, and thus can be embedded in the HTML code by your web developer.

The Web Server settings can be found in the [Configuration tab - Web Server](#)<sup>158</sup>.

Per default the port number used by the web server is 6214. We have prepared a demo web site to show what can be done and how the PBAutomation commands are implemented in the web site's code. If you like to view it, open a Pandoras Box Master - this activates the web server. Then go to your browser and enter your IP address and the port number, e.g. `http://2.0.0.100:6214` (alternatively you may copy-paste the address from the Configuration tab) - this calls the web server and shows the delivered web site. This site contains a link to the demo site which is installed per default in the web root folder under `c:/coolux/content`. If you like to write your own site please make sure to place it in this web page root directory.

Please note that the internal Pandoras Box Web Server can be used without access to the internet, it is meant to be used in (secure) local networks. For bigger installations it might be of interest that external web servers can be used in combination with the PB web server. For example, an Apache HTTP Server can be used or any other web server that supports the scripting language php. This server is then used to deliver the web sites to the browser and forward commands to or receive information from the PB web server. This setup has advantages for larger installations and for those that need access to the internet (as the PB server can be invisible), or for database applications.

++ FIREFLY™ 2D PARTICLE SYSTEM AVAILABLE FOR PLAYER SOFTWARE ++

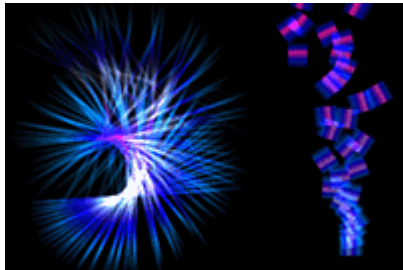

Pandoras Box now offers a particle system for Player solutions as well. Up until version 5.5 the FireFly™ particles were restricted to Server systems. The feature has been redesigned to match the 2D compositing space on Players. Particle systems make flexible content creation possible and can be used for creative as well as interactive solutions. As known from the 3D particles, various emitters can be setup consisting of different parameters that influence the look and behavior of the [FireFly Particles](#)<sup>182</sup>.

++ NEW STARTUP DIALOG AND CONFIGURATION TAB ++

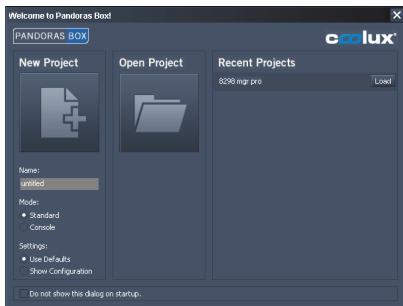

A new startup dialog pops up as soon as Pandoras Box is started. It gives you the choice to either load a (recently) saved project or start a new one.

If you like to start a new project you can name it in this dialog but it is not mandatory any more to decide the saving path at this stage. As well, the choice is given to start with or without defining advanced configuration settings.

These configuration settings can be found as usually in the [Configuration tab](#)<sup>139</sup> which has been restructured into several chapters. The configuration settings for clients were moved from the Inspector tab to here as well and



can be viewed after selecting the according client from the drop-down list. The tab in general includes some new options, e.g. regarding the behavior of the Pandoras Box Web Server.

All configuration changes concerning software settings are stored in the show file itself and are loaded when opening the project on a different computer. Settings concerning the hardware (the system itself) are stored on the local machine.

++ RELATIVE CONTENT PATH AND BUNDLE PROJECT ++

We now support a relative path whereto content can be saved. This is especially of interest for users that use the "[Bundle Project](#)<sup>129</sup>" feature.

When saving a project a folder named "assets" is generated just next to the show file. If you copy content files to that folder and drag them from here into your Pandoras Box project the content links are relative. That means that you can move the project folder ( including the \*.xml and asset folder) to every path wanted without the need of re-linking the content. You may as well use the assets folder as a "Watch Folder" in Pandoras Box...

++ IMPORTING CONTENT: WATCH FOLDER AND EXPLORER DRAG ++

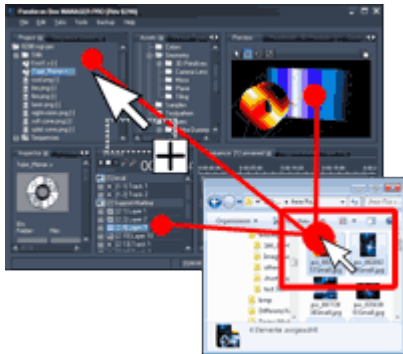

Importing content to your Pandoras Box project has been facilitated by two features.

Firstly, you may turn a folder in the Project tab into a so called "Watch Folder" by clicking on it to view its properties in the [Folder Inspector](#)<sup>198</sup> and, there, ticking the according check box. If the folder already contains files, the check box can be found after clicking on the +-symbol in front of "Attributes of Folder". A dialog opens and lets you choose a folder on the hard drive. Now, all files contained in that folder are imported to your Watch Folder and in consequence to the project. Additional files copied to the folder on the hard drive automatically appear in the Watch

Folder. Modified files are reloaded optionally (read below). Removed files, either in Pandoras Box or on the hard drive will still exist in the other place.

Secondly, it is possible to open the Windows Explorer or any other file explorer and simply drag files and folders from there into Pandoras Box. You may either complete the mouse drag in the [Project tab](#)<sup>248</sup>, in the Preview tab or in the Device Tree tab as depicted left.

++ RELOADING CONTENT HAPPENS AUTOMATICALLY ++

All files in the project are monitored constantly on the hard drive and as soon as a file changes, an automatic reload is executed by Pandoras Box. In addition the reloaded file is spread to connected clients.

In former versions you only had the possibility to reload content manually, either by restarting Pandoras Box entirely or by clicking the Reload button in the [File Inspector](#)<sup>190</sup>. A reload is necessary when content has changed on the hard drive after having been imported to Pandoras Box. This concerns especially still images as Pandoras Box saves them as a separate cache file. With the triggered reload, this cache file is now renewed automatically.

If you like to turn the monitoring off, please uncheck this option in the [Configuration tab](#)<sup>139</sup>, section "General Settings". There you find as well the option to deactivate an automatic spread triggered by a file change.

++ DEFAULT OPACITY VALUE ++

The default value for the opacity parameter has changed to be 255 or 100%. In former versions the default value has been 0. If you like to return to that behavior you may uncheck the check box "Default Opacity is full" in the [Configuration tab](#)<sup>139</sup>, section "General Settings". Please note that this option results in a different show appearance when switched during or after show programming.

The default volume parameter for video layers and ASIO tracks has changed from -96dB to 0dB and can be toggled with the same check box.

++ PARAMETER VALUE SMOOTHING ++

Setting up parameter smoothing is now possible per each Layer and Parameter separately not only for translation, rotation and scaling parameters per system. The default smoothing setting for all parameters is still 500. That means that active values are applied to the parameter not instantly or abruptly (0ms) but within 500ms in order to smooth movement.

If you like to change the time frame or deactivate the smoothing entirely, e.g. when working with a lighting console and color effects on the layers, select the client in the Device Tree tab and turn to the Inspector tab. The system-wide smoothings are still modifiable in the Inspector directly, whereas the button "Individual Parameters" opens the [Smoothing dialog](#)<sup>207</sup> that enables specific modifications.

++ PLAYLIST ++

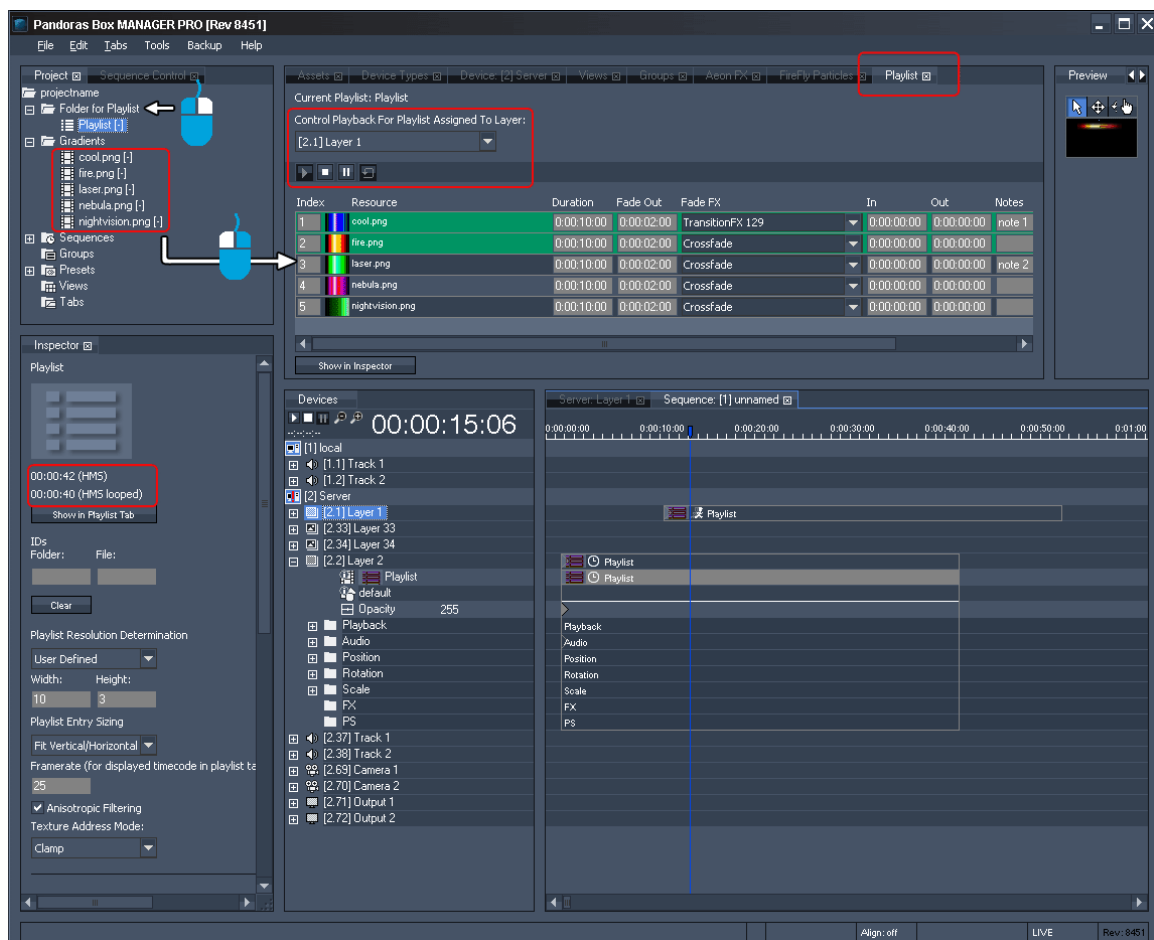

A Playlist offers the easy and fast possibility to play a certain number of media files in a row without the need of programming separate containers on the sequence.

In the [Project tab's right-click menu](#)<sup>248</sup>, you may find the command to add a Playlist. In order to add media files to it, select the Playlist and look for the new [tab "Playlist"](#)<sup>229</sup> (next to the Particles tab). Now you may drag and drop images, videos and audio files from the Project tab into the Playlist tab. Each newly dragged resource will simply be added at the end of the list (even when the Playlist is already playing back). If you like to put the files in another order, (multi-)select an entry and drag it between to others or assign a different "Index" number. Deleting files is possible with the Delete key on your keyboard or by choosing the respective command in the right-click menu. You may as well change the duration, fade time and transition effect - again, multi selection applies the chosen setting for all selected items. Further to the right you find "In" and "Out" times that take effect on videos or audio files only and define the starting and ending frame. Notes for internal use can be added too.

The overall duration of all files (minus the fade times, as there, two files are played back at the same time) results in the length of the Playlist. This is displayed in the [Playlist Inspector](#)<sup>196</sup>. It offers general settings like Folder and File ID, resolution or aspect mode.

As a last step, the Playlist needs to be assigned to a video layer. You may assign it as an active value or program it on the timeline as one single container. Please note, that you may assign the same Playlist to several video layers. Then the playback status can be different per layer, e.g. one layer can be in pause mode showing the file with index 5, the other in play mode between index 10 and 11. The Playlist tab offers a drop-down menu containing all layers the Playlist has been assigned to. Depending on this drop-down menu, the Playlist changes and displays the layer's playback mode and the currently active index file with a green highlight. In the image to the left (which can be enlarged) the chosen Playlist on Layer 1 is currently fading between two images.

++ NEW WARTER WITH AUTOMATIC MARKER CALIBRATION ++

Version 5.5 includes a new version of the [Warper](#)<sup>780</sup>. In addition to the import of third party 3D objects it is now possible to attach so called "Markers" on them. They are available using the tab "Marker". First add some markers and position them on the virtual object looking at your screen. In the "Calibration Mode" you may position the marker's second instance within the projected image on the real object. Having done so, the button "Update Cal" calculates the camera position that fits the best to the relative distance of the two marker instances.

As a last step (that can be alternatively taken before positioning the markers) you need to set the Lens factor or FOV in the tab "Camera / View". [Read more...](#)<sup>815</sup>

[Rev 7831] - Version 5.3

++ NEW MATRIX PATCHER AND MATRIX OPTIONS IN PANDORAS BOX ++



We developed a new interplay of Pandoras Box and our tool "Matrix Patcher" that is more time-saving and opens up new possibilities when working with Art-Net LED walls. Create a patch in the Matrix Patcher and export (or update) it in real-time to your Pandoras Box project with one click. Drag the new format ".pbx file" on any(!) [output](#)<sup>597</sup> and save it onto the timeline. The [preview](#)<sup>234</sup> can be toggled between the visualization of the DVI output and the Art-Net patch.

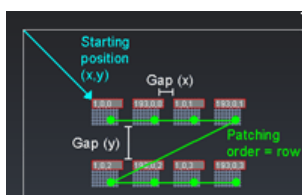

The maximum number of controllable panels has increased enormously as it is now possible to save a specific network card and target IP address within a fixture. This allows as well to separate the Art-Net data from the Pandoras Box show data. In addition to these improvements, the [Matrix Patcher](#)<sup>757</sup> offers

an array tool, a great time-saver when working with several tiles from the same type.

From now on, Art-Net data for matrix patches can be sent within any IP range, it is not tied to the Art-net specification to be sent over a 2.x.x.x network anymore!

As well, Pandoras Box accepts incoming Art-Net from outside the 2 IP range.

++ NETWORK CARD SELECTION ++

The [Configuration tab](#)<sup>139</sup> offers per each protocol a drop-down lists with all network cards installed on the system. Select one and restart the application. Now the entire Pandoras Box communication of master and clients will be transferred by this defined adapter and its IP address.

You may choose a different network adapter for the [Pandoras Box show data](#)<sup>146</sup>, [DMX / Art-Net Mode](#)<sup>146</sup>, [CITP Thumbnail Exchange](#)<sup>146</sup> and [Streaming ACN](#)<sup>153</sup> and of course for the [client](#)<sup>294</sup>.

Thus you can for example separate the show data generated by the video / graphic containers and their keys in the timeline from all Art-Net data.

++ BREAKOUT PANES ++

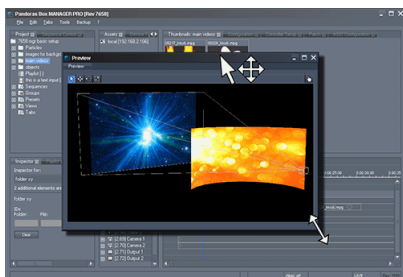

The User Interface of Pandoras Box master software may be altered in a more flexible way. Right-click on a pane or tab and choose to break it out of the main frame. Now it can be moved and scaled independently. In addition each tab can be split into two. [Read more...](#)<sup>290</sup>

++ IMAGE SEQUENCE AND UNCOMPRESSED PLAYBACK ++

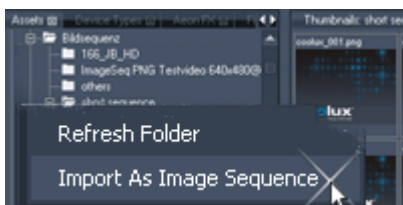

[Image sequences](#)<sup>99</sup> have the advantage of keeping the best possible image quality, preserving alpha channel information and allowing more flexible and safe workflow. With Pandoras Box 5.3 it is now possible to add image sequences directly to your project and play them back.

In addition we do offer SSD drives for our Server hardware.

Compared to normal hard drives they allow better playback performance regarding image sequences and other uncompressed video formats.

++ WIDGET DESIGNER DEVICE ++

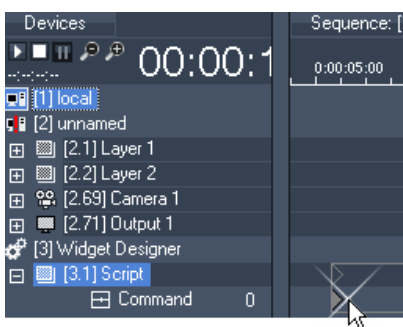

The new device type "Widget Designer" allows to execute commands directly from the timeline in a very convenient workflow. The commands can be now stored within keys. Primarily, [Widget Designer](#)<sup>864</sup> has a built-in script language allowing you to create customized routines of commands that control specific features of Pandoras Box, Widget Designer or other 3rd party products and protocols but it was only possible to call these commands from Widget Designer itself. Currently there are over [800 commands](#)<sup>1260</sup> available.

Now it is possible to execute commands as soon as Pandoras Box' timeline calls them up, that means at a defined time in the show. [This topic](#)<sup>609</sup> explains in detail how to program Widget Designer commands directly into the timeline and how to get trigger values from it.

++ CONTENT AS INTERFACE: LAYER PICKING ++

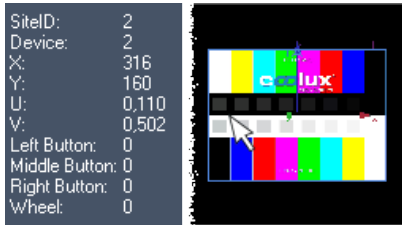

With the feature "Layer Picking" in version 5.3, content interaction has gone one step further. It is now possible to recalculate the mouse position within the preview or even the client's fullscreen window and thus recognize what layer is touched and where exactly on the layer the mouse is located. A layer has become a true interface. [This chapter](#)<sup>244</sup> explains "Layer Picking" in more detail.

++ RENDER PASSES AND BLACKLEVEL COMPENSATION++

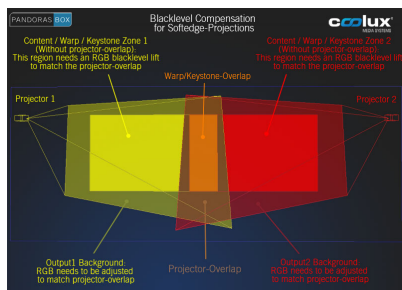

From now on, layers can explicitly set to be included or excluded by the first Pandoras Box render pass and thus be placed outside from the warp / keystone / softedge structure. This setting is available in the [layer's Inspector](#)<sup>208</sup>. More details regarding the [Video Processing Pipeline](#)<sup>297</sup> can be found here.

Combined with new effects, it allows to set up [blacklevel compensation](#)<sup>613</sup> when working with multi-softedged projection(s).

++ IMAGE CONVERTER: Transparency in mpeg-videos ++

The [Image Converter](#)<sup>838</sup> is able to render a mpeg video from an image sequence. In version 5.3 it includes the feature to generate a black-and-white mask in addition to the main video. You may choose to [include the b/w information](#)<sup>842</sup> side-by-side like, resulting in one video. In Pandoras Box, the Masking effect "Alpha Left Right" (respectively "Alpha Top Bottom") separates the two videos again and renders them while applying a keying effect to the main video.

This workflow leads to transparency (alpha channel) in mpg-videos and saves far more performance than other codec solutions.

++ SOFTWARE DEVELOPMENT KIT ++

There are new functions within the Pandoras Box SDK (PB Automation). Please refer to the chapter [SDK](#)<sup>1532</sup> that has been revised and now offers many examples and detailed description.

++ UNLIMITED ASIO TRACKS++

The number of available ASIO Tracks has been increased. Unlimited audio tracks for synchronized audio playback, are available for:

- all Pandoras Box Server PRO versions
- Pandoras Box Manager PRO
- Pandoras Box Editor and
- Pandoras Box Offline Manager

See [Audio Tracks](#)<sup>[578]</sup> for more information. The [Product Overview](#)<sup>[65]</sup> informs about the available number of ASIO Tracks on other products.

++ WIDGET DESIGNER VERSION 4 ++

There is a new version for the [Widget Designer](#)<sup>[864]</sup>. Among many features and enhancements, the new build-in [Web Server](#)<sup>[1177]</sup> allows to export pages to be accessed online with using a standard web browser.

[Rev 7135] - Version 5.1

++ STREAMIX ++

[StreamiX](#)<sup>[650]</sup> is a TCP based Desktop Streamer that works as a Live Input in Pandoras Box. This tool streams any Windows XP / Win7 desktop region without using capture cards.

++ MEDIA ENCRYPTION ++

[Pandoras Box Media Encryption](#)<sup>[216]</sup> is a technology that encrypts media in order to protect content from being played back by unauthorized persons or systems without permission. To decrypt the media it is necessary to possess the correct key and policy. They can be transmitted digitally or be bind to an optional additional hardware Media Dongle to make the process even more safe. It is possible to set a time limit for the playback.

++ LIGHT AND SHADOW ++

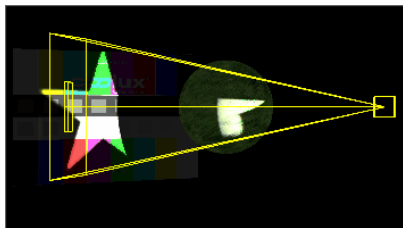

[Light Layers](#)<sup>[582]</sup> allows setting a light source to illuminate other Video and Graphic Layers. The light source is customizable, e.g. it can be adjusted in its direction and color. As well it can project any media, images and videos. Video and Graphic Layers with a [Light Effect](#)<sup>[484]</sup> may receive the light and cast shadows on themself and other layers. Again, the way how they reflect light is adjustable, thus it is possible to give them a specific material look.

++ ASIO CLIENTS: Audio Tracks on all playback products ++

All Pandoras Box 5.1 playback products support ASIO Audio Tracks. In most cases the number of ASIO Tracks available to each playback product is equal to the number of Video Layers. For detailed information please have a look at the [Product Overview](#)<sup>[65]</sup>.

++ DYNAMIC WARPING AND NEW WARTER 3D ++

Users can now animate and control the Warper via keys in the timeline or any other Art-Net sending device. In return the warping object influences the layer on the timeline in real-time.

This new development is perfect for realizing projects that involve the tracking of moving head projectors and moving sets, where the warping has to change in a seamless way according to the different positions. Click [here](#)<sup>[828]</sup> for a step-by-step tutorial.

With version 5.1 there are two different Warper variations available. The Warper 2D is available for all Player products. The new Warper 3D is available on Server products.

3ds Max files can now be directly imported and used for warping - they can be edited too. In addition, the Warper mesh points can be moved and worked with along the Z axis. Camera View settings are possible and can be applied to a Camera Layer in Pandoras Box with one mouse click. Global planar textures can now be applied to multiple meshes as well.

The Warper 3D will be explained in detail in the next version of this manual.

++ PRESETS ++

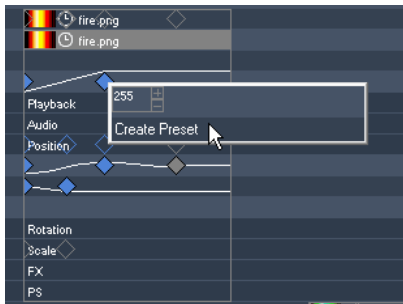

The preset feature has been improved. Not only single snapshots from active values can be taken. Now, a preset can hold an entire set of keys. Both preset variations can be applied at any (other) point in time to any (other) layer. In this way one situation can be created and then be reused severally in the programming process. In addition a preset can be modified in later programming and automatically change all according keys in the sequence.

++ QUAD SERVER AND PLAYER SUPPORT 3G++

V5 QUAD Server and QUAD Player workstations now support 3G. The manual explaining the Quad setup can be found [here](#)<sup>662</sup>.

[Rev 6700] - Version 5.0

++ MULTI-INSPECTOR ++

The [Inspector](#)<sup>188</sup> has been improved, allowing a faster and easier work flow. It is now possible to multi-select items and modify them all at once. This applies to all possible items such as key frames and containers, cues, files and layers. The Inspector informs you how many items are selected and applies the new settings to all in the same way.

++ NEW MATRIX PATCHER AND PIXEL REMAP FX ++

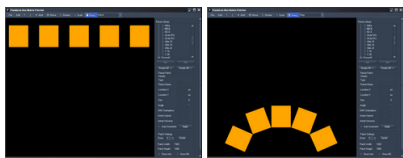

Pandoras Box is featuring an easy and fast work flow when working with rotated LED video tiles.

Previously the Matrix Patcher was only used if working with LED tiles controlled via Art-Net. From now on it plays also an important role if working with LED video tiles that are connected via DVI and a LED video processor. Most LED video processors are capable of creating only horizontal and vertical layouts for the video tile alignment. As soon as any of the tiles are rotated (in any angle), content mapping can be very difficult and complex to setup. For those creative applications [Matrix Patcher](#)<sup>757</sup> and a new [Pixel Re-Mapping FX](#)<sup>525</sup> were designed.

## ++ IMAGE CONVERTER ++

[Pandoras Box Image Converter](#)<sup>838</sup> now supports direct Mpeg Encoding (where PB Encoder license is available). This will decrease render and converting time significantly.

## ++ SPLITTER ++

[Pandoras Box Splitter](#)<sup>848</sup> now allows to export 24bit png files requiring less space on the hard disk. In addition a new function "Output Auto-Alignment" allows easier and faster work flow.

## ++ CURVE EDITOR ++

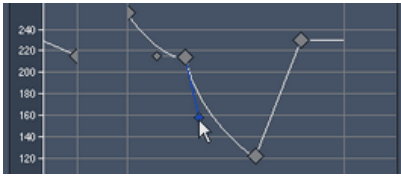

The [Curve Editor](#)<sup>161</sup> has been improved: New value references, different mouse modes and an improved zoom function create a more comfortable overview and faster work flow.

[Rev 6107] - Version 5.0

## ++ VIDEO EXPORT &amp; LIVE INPUT RECORDING ++

The video export offers users to greatly improve their work flow and export entire scenes as HD video while having the flexibility of a real-time editing system. For live video ingest, you can now record & capture from any live input source up to 2K/HD.

## ++ AEON™ FXENGINE ++

The dynamic shader effects engine enables users to create and combine an almost unlimited number of effects. All effects and animations are automatically synchronized across the system network, see [AEON™ FX Engine](#)<sup>136</sup>.

## ++ FIREFLY™ 3D SYSTEM ++

FireFly™ allows for the creation of elaborate real-time particle effects in a true interactive 3D compositing space. Various emitters can be setup and applied with forces such as Wind & Gravity, see [FireFly Particles](#)<sup>182</sup>.

## ++ QUAD HD Output ++

The new QUAD Server and QUAD Player workstations offer users up to four independent HD DVI outputs with built-in EDID Management.

## ++ ASIO Multi-Channel Audio++

The Pandoras Box Manager Software now supports ASIO audio interfaces and offers synchronized multi-channel audio playback, see [Audio Tracks](#)<sup>578</sup>.



++ LAYER FLEXIBILITY ++

It is now possible to re-structure individual layers easily per drag & drop. This way the rendering order can be instantly re-ordered and organized according to your project setup. Arranging your layer structures has never been easier, see [Device Tree](#)<sup>168</sup> chapter.

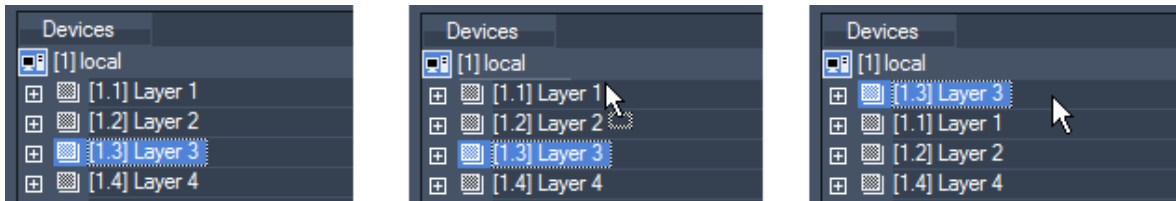

++ UNLIMITED GRAPHICS & SOURCE ROUTING ++

Create and add any number of graphic layers depending on your project needs. Make use of the new efficient source routing to route any video layer sources to any other layer.

[Rev 5771]: - Version 4.7

++ NEW WARPERS FEATURES ++

The [Warper](#)<sup>780</sup> allows now to work with [several meshes](#)<sup>825</sup> inside one project simultaneously.



The Warper can be used to [merge several .x-files](#)<sup>789</sup> as well.

++ NEW MATRIX PATCHER FEATURES ++

With the new [Matrix Patcher](#)<sup>757</sup>, users can work with patches up to Full HD resolution (1920x1080 px) and can set up individual fixtures in a variety of sizes. It allows the patching of matrixes that can mix e.g. moving lights and LED fixtures, which can also be individually rotated and scaled. The new Matrix Patcher comes with a fixtures library.

++ THREE NEW WORKFLOW TOOLS IMPLEMENTED ++

[IMAGE CONVERTER](#)<sup>838</sup>

Many operators find themselves being handed an ever greater variety of picture data with different sizes. The Image Converter can recalculate images prior to them being used, in order to maximize the overall system's performance efficiency. It also offers high performance batch conversions and can turn image sequences into video files.

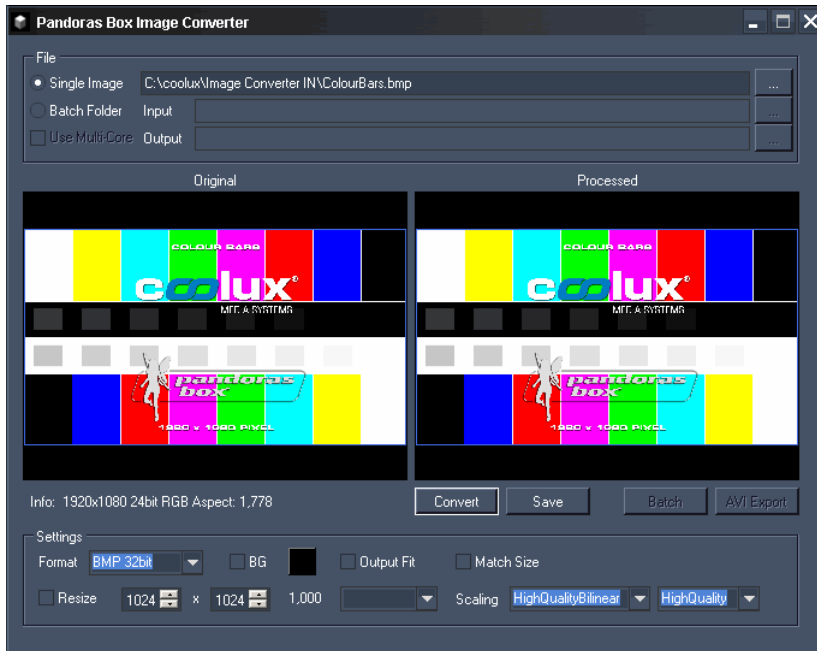

[DOME MASTER](#)<sup>832</sup>

This tool is a spherical map converter that allows the conversion of dome master files to spherical map files, making it an essential tool for the dome content production workflow. Its sub-pixel accuracy allows optimum image sharpness for large scale projections. It processes up to 8K files.

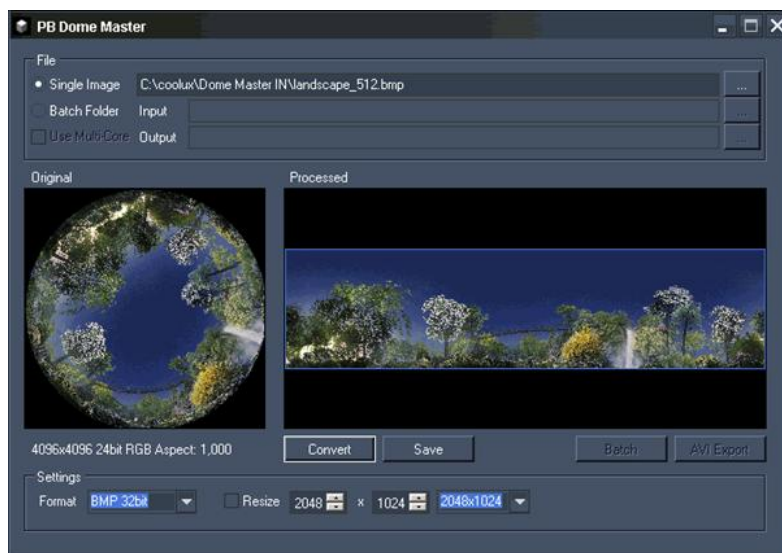

[SPLITTER](#)<sup>848</sup>

With the Splitter, one can create files for panoramic projections and/or dome projections. The Splitter allows users to render out the individual split files needed for individual projectors. The Splitter can also batch image sequences and export video files.

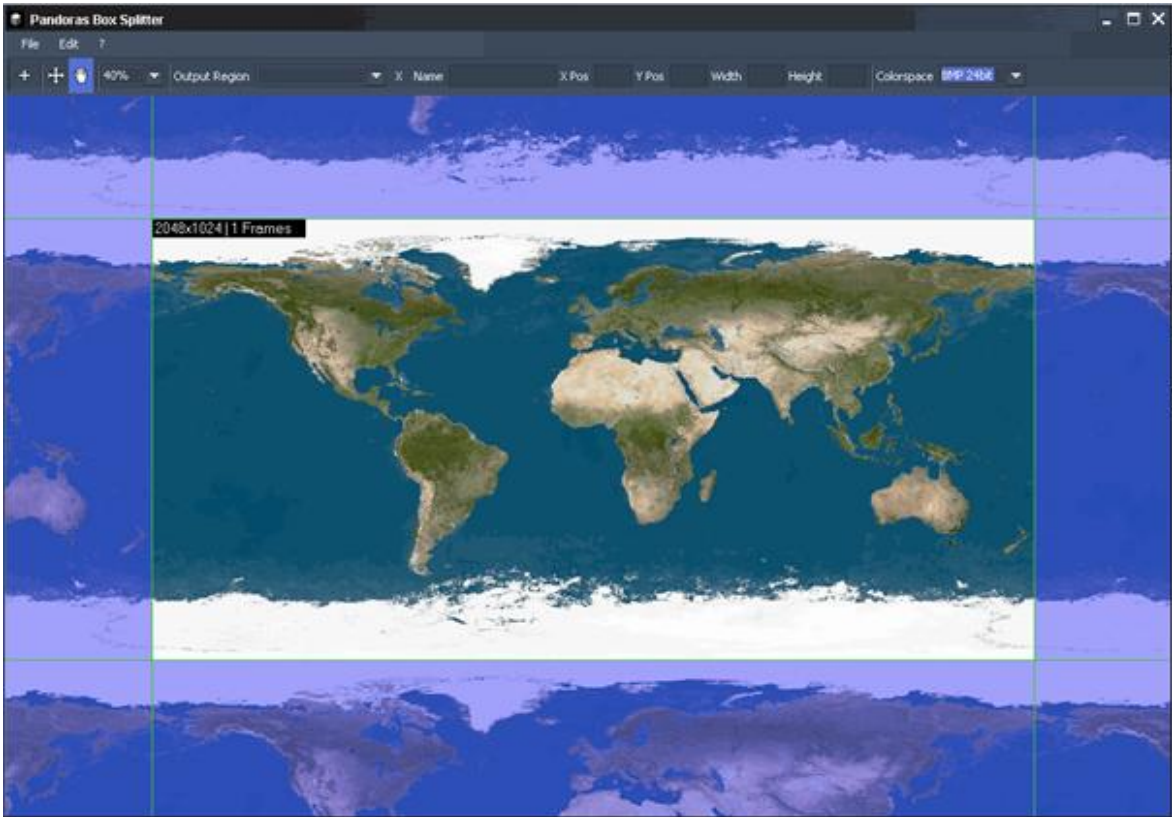

[Rev 5237]:

++ USER FEEDBACK IN CASE OF LOW MEMORY SITUATIONS ++

This maintenance update includes an optimized memory management and user feedback in master software in case of low memory or failed events due to low memory. If you are running into low memory situations you will see that the status bar turn red. These warnings will show up if the output display is inconsistent with timeline or device parameters.

Example:

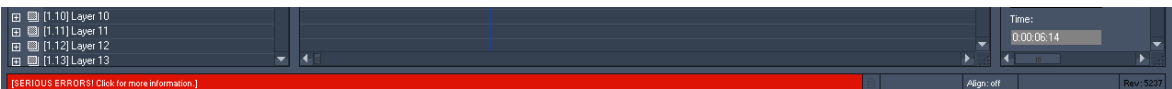

Click on the status bar to see the cause of the warning.

++ HIGH PERFORMANCE MODE ++

With Pandoras Box version 4.7 50/60p video playback has introduced a "High Performance Mode" that requires more system and gpu ram. From this release on the "High Performance Mode" should only be used if you intend to playback or process high frame rate content or live inputs. This feature can be found in the client/device inspector or if you are running in standalone mode in the [Configuration Tab](#)<sup>158</sup>.

++ TEXT ASSET ENHANCEMENTS ++

The [Text Asset](#)<sup>197</sup> in Pandoras Box now allows using multi line, non-Latin characters, styles, colors and alignment. It is possible as well to center the text input on the layer.

++ MPEG4 USAGE ++

The MPEG4 file types .mp4, .m4v and .m4a are legal asset types now, see [Video Formats](#)<sup>102</sup>.

++ ENHANCED AUDIO USAGE ++

- PB now allows using built-in Audio capture devices. They can be found in the asset tab for each device in the Live Inputs folder.
- The audio track of a video file may now be muted, see [File Inspector](#)<sup>190</sup>.

[Rev 4804]:

++ FLUIDFRAME ++

[FluidFrame](#)<sup>190</sup> Technology addresses a challenging and highly complex topic in frame rate conversion common to all media servers, live video processing units as well as signal processing in general.

With FluidFrame<sup>TM</sup>, a smooth cross-conversion that can take any input and output frame rate, supporting both interlaced and progressive sources and clips is possible now.

This way for example 59.94 video input signals are displayed without any frame drop on 60Hz output displays. FluidFrame<sup>TM</sup> can therefore also handle 50Hz to 60Hz real-time conversions.

In addition to this, it allows smooth playback of high-speed frame rates such as 50 or 60p content and higher. FluidFrame<sup>TM</sup> Technology can be applied to any live video input or content playback scenario ranging from straight forward Live Video processing to the synchronization of multiple HD SDI streams for Live Stereo 3D applications.

++ NEW WARTER ++

The Pandoras Box Warper Rev. 19 allows the user to create cut outs and a [ScreenMask](#)<sup>810</sup><sup>TM</sup> while painting onto the projected surface from within PB Warp.



The new zoom and pan features allow precise texture based warping.

[Rev 4621]:

#### ++ NEW PB AUTOMATION COMMANDS++

If you want to write your own software to control Pandoras Box from outside, please have a look at the description of our [SDK](#)<sup>[1532]</sup>. Newly added commands:

- AutoAddContentFromLocalNode,
- AutoSaveProject,
- AutoChangeFullscreenStateByID,
- AutoChangeFullscreenStateByIp.

#### ++ MENU ITEMS TO START WARTER & MATRIX PATCHER FROM WITHIN PANDORAS BOX++

Have it simple! The Tools menu now allows you to start [PB Warp](#)<sup>[780]</sup> and [PB Matrix Patcher](#)<sup>[757]</sup> directly from within the software.

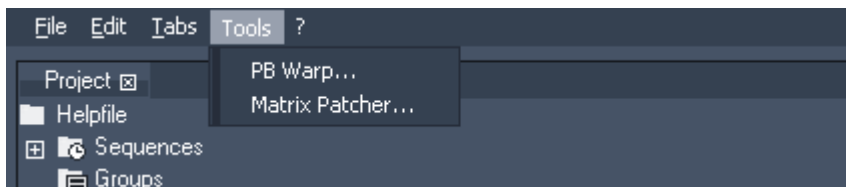

[Rev 4569]:

#### ++ MATRIX PATCHER BACKGROUND IMAGE ++

The Matrix Patcher now allows you to load a [Background Image](#)<sup>[758]</sup> in your patch to simplify patching.

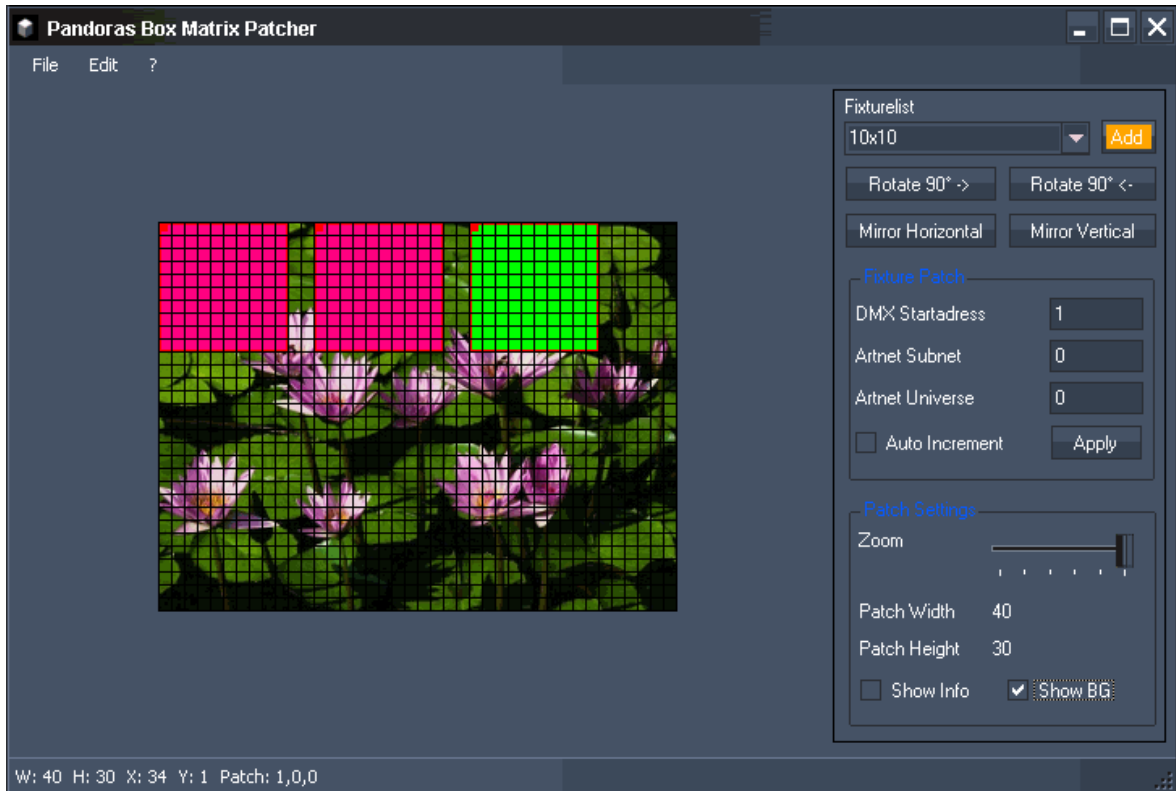

[Rev 4417]:

++ ENCODER EXTENSION NOW ALLOWS TO INCLUDE AUDIO++

From now on the a video file including audio can be encoded not only to a Mpeg Video Elementary Stream with separate audio part, but also to a Mpeg Audio and Video Program Stream, please see [Encoder Extension](#)<sup>104</sup>.

++NEW PB WARTER++

The [PB Warper](#)<sup>780</sup> Rev. 12 has new features implemented. You now have the possibility to:

- also rotate and scale selected mesh segments,
- cut out selected faces in the mesh to easily create a mask,
- load a texture (picture or video) directly on the mesh inside the Warper to control if the mapping is done perfect.

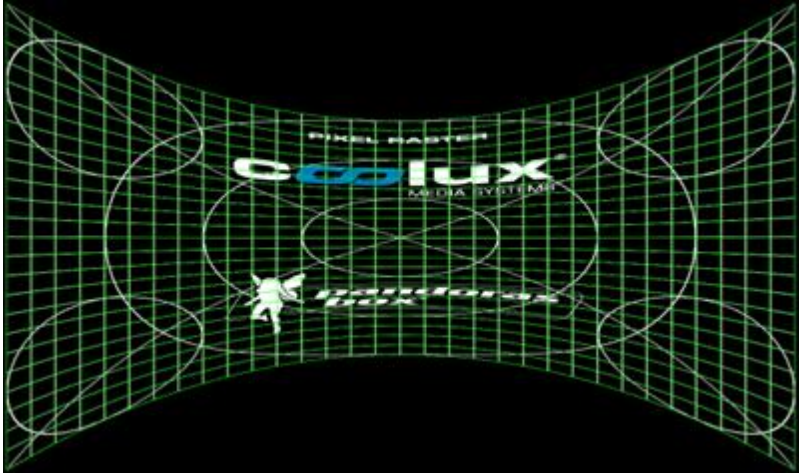

[Rev. 4254]:

++ BUNDLE PROJECT ++

The [File Menu](#)<sup>129</sup> now allows you to bundle your project under a new name and location. All content used in the timeline will be copied to the new location as well as the show file. This option allows you to only have one folder to archive your show on a external hard drive. To play your show again, just copy this folder at its original location on your hard disc and all paths will be recovered.

++ AUTO ASPECT RATIO ++

Choose for each layer how it should handle the aspect ratio of the loaded media files. Four modes are available, see detailed information in the [Layer Inspector](#)<sup>208</sup>:

1. none (by default) - same behavior like before, see Figure B.
2. Horizontal Fit, see Figure C.
3. Vertical Fit, see Figure D.
4. Horizontal and Vertical Fit, see Figure E.

Example:



Figure A: this is the original media file.



Figure B: Layer Aspect Ratio is set to "None" and the image is scaled to a 4:3 layer.

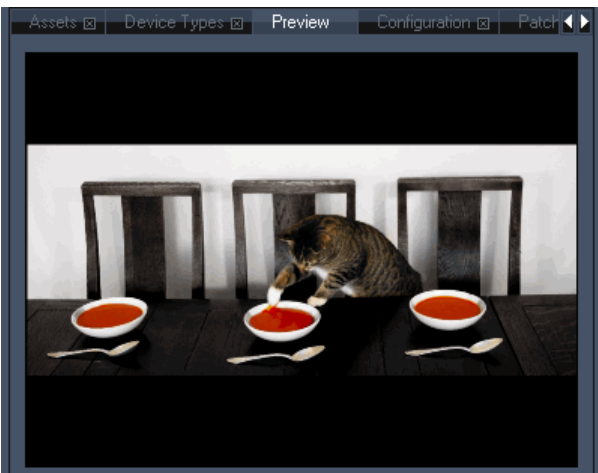

Figure C: Layer Aspect Ratio is set to "Horizontal Fit", the files aspect ratio is kept and it fits horizontally into the layer.



Figure D: Layer Aspect Ratio is set to "Vertical Fit", the files aspect ratio is kept and it fits vertically into the layer.

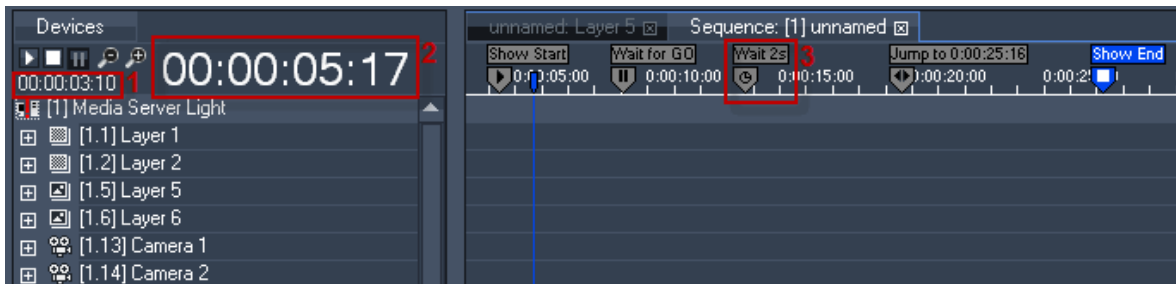



Figure E: Layer Aspect Ratio is set to "Horizontal and Vertical Fit". Regardless whether the file is upright or crosswise, all parts of the file will always be shown in its original aspect ratio.

++ NEW SEQUENCE FEATURES ++

- Countdown for next Cue in Timeline (1)
- Large Display of Sequence Timecode (2)
- Cue Names displayed on top of Cues (3)
- New Cue mode available: Wait Cue, see [Cue Inspector](#)<sup>204</sup> (3).



++ COUNTDOWN FOR ASSETS IN DEVICE VIEWER ++

The Device Viewer shows now the asset's countdown (when the file is stored to the timeline).

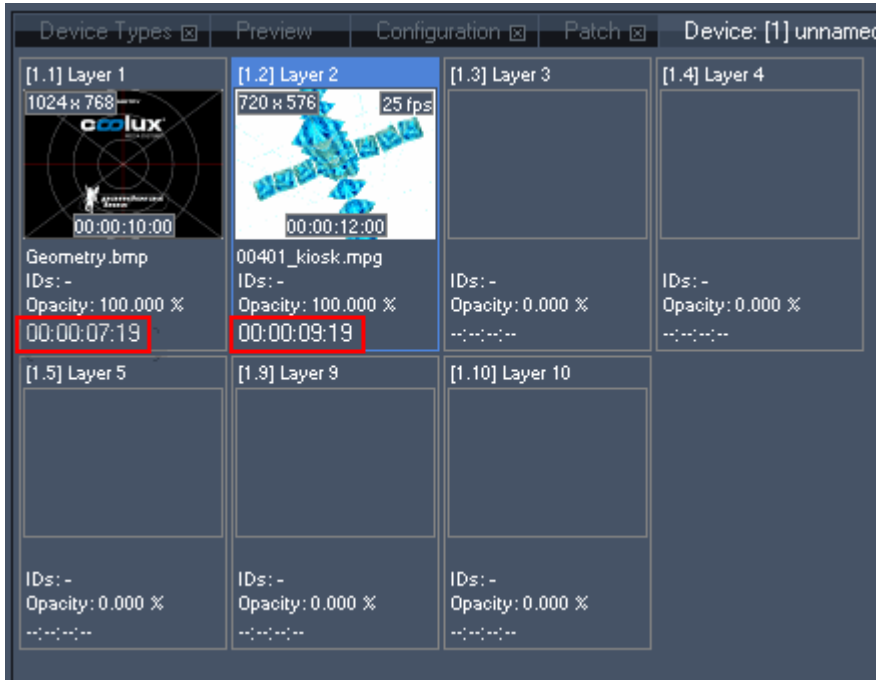

**++ ENCODER EXTENSION GETS ITS OWN TAB ++**

You will find the Encoder Extension now in its own tab instead of being integrated in the Configuration Tab. Open the Encoder Extension via the Tabs Menu - Extensions - Encoder Extension.

[Rev. 4135]:

**++ CENTERED VALUES ++**

Most of the fader values now appear in centered position by default, whether the readout is decimal or percentage. To set this option back to non-centered position, please refer to [configuration tab](#)<sup>139</sup>.



Figure 1: Fader values appear in centered position (left side) or in non-centered position (right side)

++ LINK PARAMETERS ++

To [link several parameters](#)<sup>165</sup> click on the link icons above the faders in the device control tab or left to the listed parameters in the device tree. If you move one of the linked faders all linked parameters will accept the values in relation to the moved fader. Please note that only parameters from the same type (like rotation or scaling) can be linked.

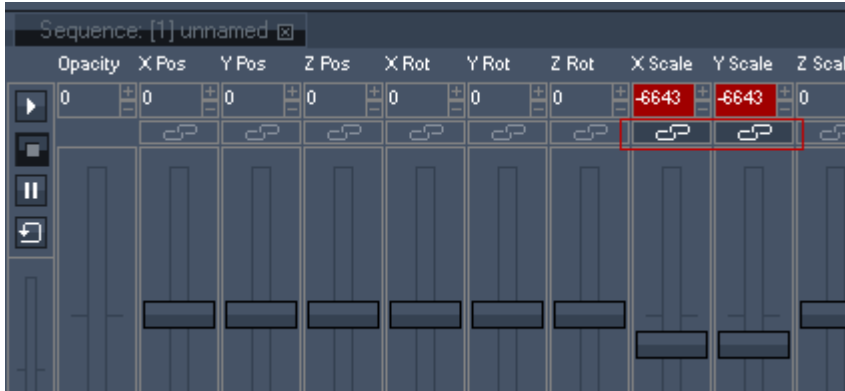

Figure 2: X and Y Scale are linked as you can see on the dark grey linking icons

++ SEQUENCE TRACKING ++

The enforce defaults handling for timeline tracking is now optimized. There is also a new drop down menu.

Please see the pages [Sequence](#)<sup>260</sup> and [Tracking](#)<sup>269</sup> for a better understanding which mode results in no / half / full path dependency!

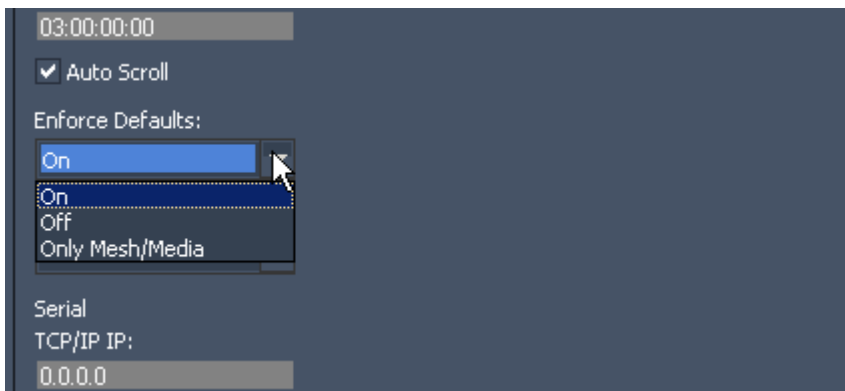

Figure 3: Choose between different Sequence Tracking options

++ AUTO SPREAD RESOURCES ++

When adding new content to your project, it will now automatically be spread to all available clients. To change this default setting back to manual spreading, please see the resource options in the [configuration tab](#)<sup>141</sup>.

The improved [taskmanager](#)<sup>275</sup> lets you monitor if a site is still loading files and if all file send and receive actions that were initiated by a file or folder spread process.

If the site icon in the device tree gets a green stripe it indicates that the site is still active receiving or loading assets.

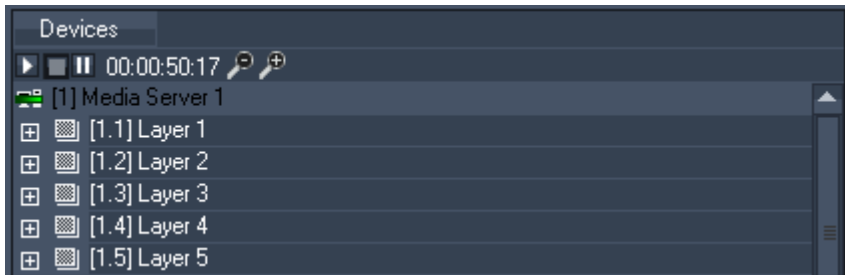

Figure 4: The green stripe in the site icon lets you know, that the site is still busy receiving or loading assets.

++ RENAME LAYERS AND CAMERAS ++

You now have the ability to rename the labels of sites, layers and cameras for better orientation, especially in complex projects. Do this via right click on the device or pressing [F2]. Please see the [Device Tree Context Menus](#)<sup>168</sup>.



Figure 5: Example for renamed devices

++ HIDE / UNHIDE DEVICES ++

Hide/unhide several devices in the device tree now very fast and easily. Select the devices using CTRL or SHIFT key, do a right-click on one of these devices and click on Hide. Please see the pages [Device Selection](#)<sup>172</sup> and [Structured View](#)<sup>178</sup> for details and enhanced workflow.

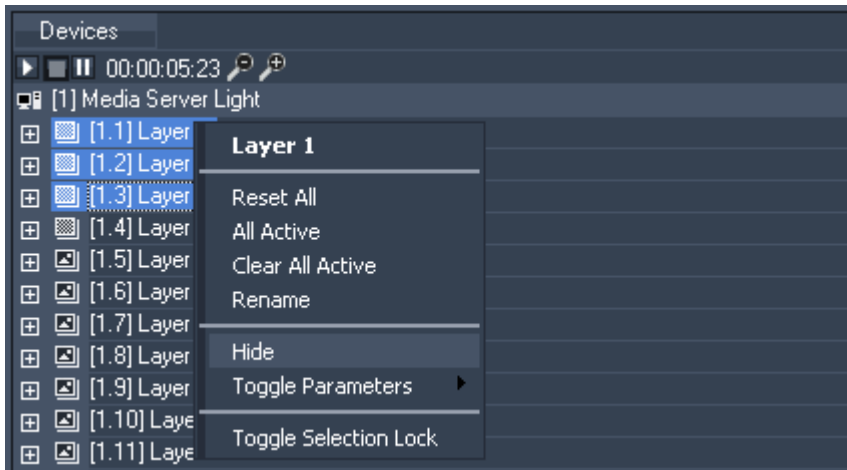

Figure 6: Hide several layers via the context menu

++ ENHANCED DEVICE MULTI-SELECTION ++

You also have the possibility to keep a multi-selection in the device tree while modifying other devices via [Selection Lock](#)<sup>176</sup>. Right-click on one of the devices and choose Toggle Selection Lock or press CTRL+L. A lock icon will display the locked device selection.



Figure 7a: The lock icon in front of the layer labels shows signifies a locked selection.

If you now e.g. click on Layer 4, it will be loaded into the device control tab. You are able to modify this layer and keep your locked selection for later purposes.

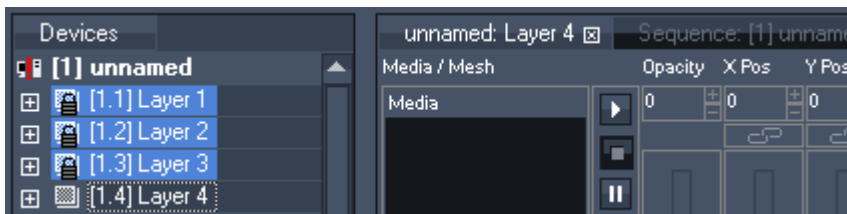

Figure 7b: Layer 4 is loaded into the device control tab and can be modified although you keep your selection.

++ NUMBER OF SHOWN LAYERS IN NEW SITES ++

You are now able to define how many layers should be shown if you add a new site to your project, depending on how you have the best overview. Use the [Configuration Tab](#)<sup>139</sup> to modify the default number of two video layers and two graphic layers. You can easily show all layers later on by using the site context menu.

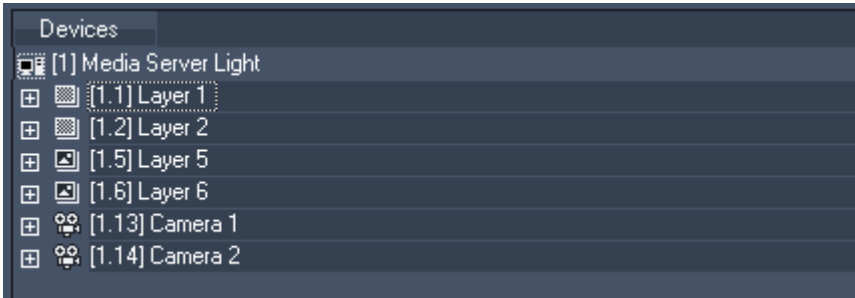

Figure 8: 2 video and 2 graphic layers are shown by default when adding a new site.

**++ ENHANCED DEVICE VIEWER ++**

The device viewer now only displays all devices that are shown in the device tree.

Hidden devices are not displayed in the device viewer anymore.

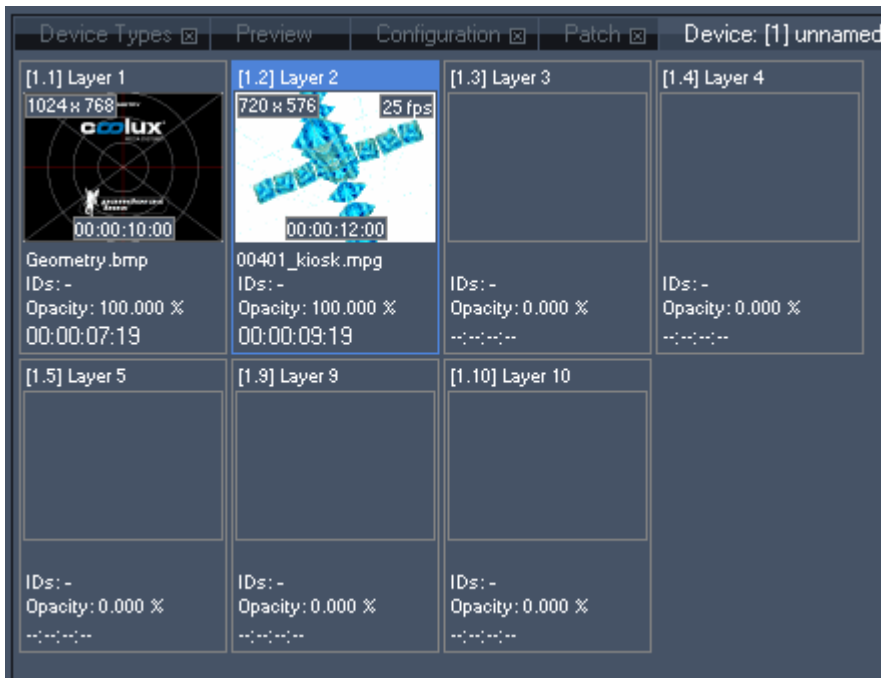

Figure 9: The device viewer

You also get more information about the loaded files such as size and frame-rate. Please see the [device viewer](#)<sup>182</sup> page for detailed information.

**++ THUMBNAILS FOR TRANSITION FX ++**

Thumbnails in the Transition FX list now make it easier to go over the different transition effects.



Figure 10: The Transition FX list with thumbnails

++ NEW SHORTCUTS ++

- [Toggle Ignore Next Cue](#)<sup>262</sup> [CTRL+SHIFT+I]

The behavior of next cue in the current sequence will be ignored once, no matter if it is a pause, stop or jump cue. The nowpointer will keep on going as if it was a normal play cue.

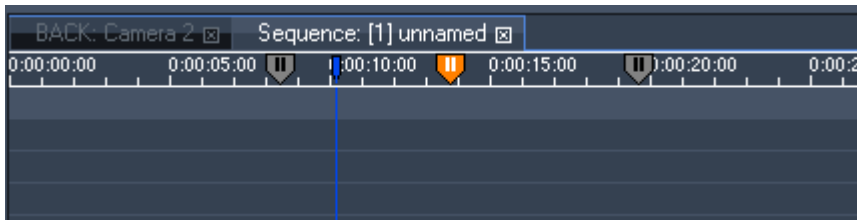

Figure 11: When Toggle Ignore Next Cue is set, the ignored Cue will be highlighted in orange.

- [Lock Selection](#)<sup>176</sup> [CTRL+L]

To keep a multi-selection in the device tree while modifying other devices, right-click on one of the devices and choose Toggle Selection Lock or press CTRL+L. A lock icon will display the locked device selection.

- Move Keys [SHIFT+ Arrow right/left]

The selected keys in the sequence can exactly be moved frame per frame forward or backward.

- Jump to Next / Previous Cue [CTRL+ALT+ Arrow right/left]

- Change of fader value by arrow keys [Arrow right/left]

- Change of fader value by arrow keys (factor 10) [CTRL+Arrow right/left]

See here the list of all [keyboard shortcuts](#)<sup>292</sup>.

++ ICONS DISPLAY CLIP MODE ++

A clip stored on the timeline can be in two different [clip mode states](#)<sup>202</sup>. The default setting is Lock to Time, this means that the video clip synchronizes to the timeline. All video playback keys inside the clip do not take effect in this mode. Lock to Time is displayed by the clock icon inside the clip, see figure 7.

If Lock to Time is disabled, the clip is in a free-run mode and the video playmode keys (play once, play loop, pause, stop) take effect. So although the timeline is pausing, the clip where the nowpointer

stays on could play if it has a play key stored. The running-stick-figure icon indicates that Lock to Time is disabled.

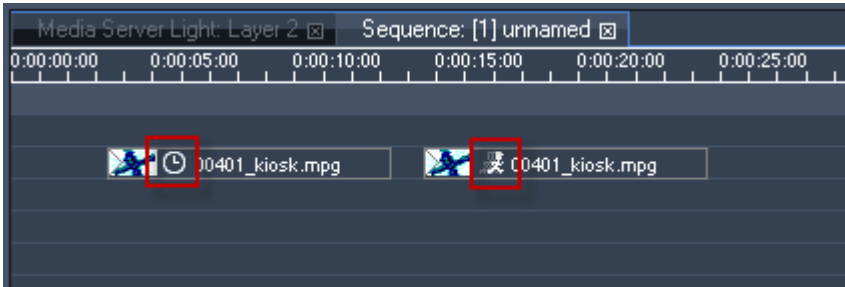

Figure 12: The first clip is locked to time; the second clip is in free-run mode.

++ BLOCK EXTERNAL INPUT FOR LAYERS ++

When controlling Pandoras Box through any input data like Art-Net, MA-Net, TCP etc, you now can [mute layers](#)<sup>208</sup> not to be influenced by the incoming commands.

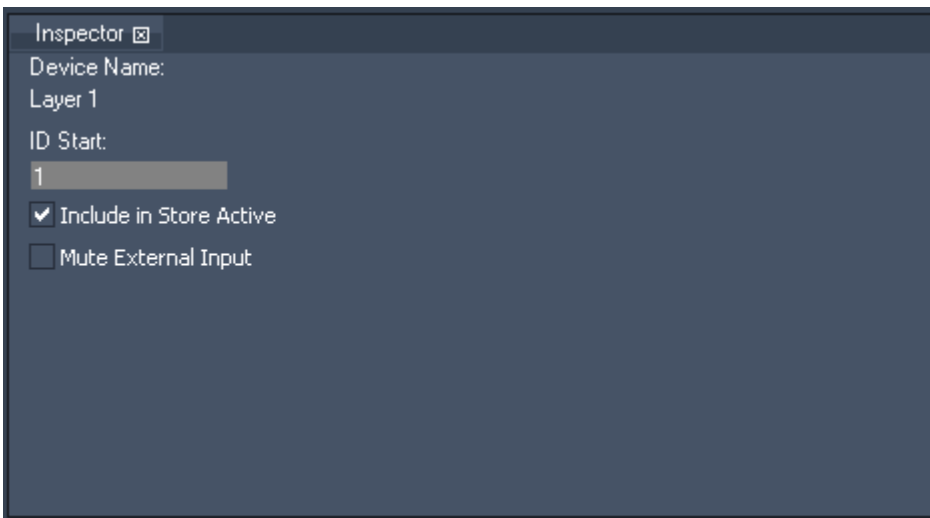

Figure 13: Check Mute External Input to block any data from outside

## 4 FIRST STEPS AND TROUBLESHOOTING

This chapter is for all who are new to the Pandora Box product family, it covers:

- a [product overview](#)<sup>65</sup>: how are the different products called (hardware and software) and what are they used for
- how to [troubleshoot](#)<sup>69</sup> (e.g. for technicians who have to maintain a Pandoras Box installation but did not attend a training)
- the most important tabs and buttons of the user interface to do [basic changes](#)<sup>89</sup>



## 4.1 PRODUCT OVERVIEW

### Introducing the Manager, Player and Server

The coolux Pandoras Box product family consists of software and hardware based solutions. In short:

The "Manager" product range is a software solution. Hardware can be custom hardware or Pandoras Box hardware. Mainly, the Manager functions as a master system used for show control. There is also a special Manager Offline solution that is used for show pre-programming and video editing. Other differences are listed in the [product structure table](#)<sup>66</sup> at the end of this chapter.

The Pandoras Box Player product range is divided in two groups of upgradeable models featuring a real-time 2D compositing engine for image and video playback.

A "Software Player" can be purchased as a software solution to be free to run it on custom hardware or Pandoras Box hardware. The "Player" and "Compact Player" solutions are bound to Pandoras Box hardware. As shown in the [product structure table](#)<sup>66</sup>, the product defines, among others, the number of available layers and sequences.

Any Player can run in master mode for show control to control other clients, in master mode as stand-alone to combine show control and video playback on one output in one machine, or as a third solution, in client mode for video playback on one or multiple outputs.

The Pandoras Box "Server" product range features a real-time 3D compositing engine for image and video playback at any size.

A Server is always bound to Pandoras Box hardware. Depending on the product, the number of available output viewpoints (cameras) for individual output setup differs. A Servers includes all different [layer types](#)<sup>296</sup>.

A Server can run in master mode for show control to control other clients, in master mode as stand-alone to combine show control and video playback on one output in one machine, or as a third solution, in client mode for video playback on one or multiple outputs.

### Show Control

We offer the Pandoras Box Manager for interactive media control. It is a timeline based show control solution, allowing fast and easy on the fly programming and show setup. A Manager is always the so called master system, to which one or several clients connect to. The master administrates client(s), media file(s) and timeline(s) whilst the client renders and plays back what the master commands. A client can be either a Player or Server.

Note that a Player or a Server can be used as a master software as well, e.g. if used stand-alone.

Please refer to the chapter [User Interface > Master](#)<sup>126</sup> to learn more about the elements of the master's user interface.

As additional interactive media control device we offer the [Widget Designer](#)<sup>864</sup>.

### Video Processing / Playback

Pandoras Box Servers and Players make the scalable Pandoras Box playback system. They communicate directly via TCP/IP with any Pandoras Box master control system. A synchronization process takes care of all connected client devices to be controlled in sync. Read more about the [master / client remote setup](#)<sup>647</sup>. In difference to a Manager, a Player or Server can toggle into full screen.

Please refer to the chapter [User Interface > Master](#)<sup>126</sup> to get more information about the elements of the Server's / Player's user interface if they are started in the master mode. The chapter [User Interface > Client](#)<sup>294</sup> explains the client's user interface. [Device Control](#)<sup>296</sup> describes the different device types, i.e. layers.

For hardware settings regarding the included input and graphic cards, please read the topic about [Hardware and Accessories](#)<sup>659</sup>.

## Accessories

All Pandoras Box Systems are designed to interact with multiple protocols and output devices. Beside the Pandoras Box product range other SMPTE, DMX, RS232 / 422 or any TCP/IP devices might be remote controlled from any timeline as well. This allows perfectly synchronized show control. We offer specialized interfaces for SMPTE I/O, DMX, serial and sensor control.

All accessories and optional features are described in [Hardware and Accessories](#)<sup>659</sup> whilst the programming is detailed in [Device Control](#)<sup>296</sup> and [External Control](#)<sup>621</sup>.

## Additional Tools

There is software pre-installed on Pandoras Box hardware called the [PB Menu](#)<sup>754</sup>. It starts automatically when booting. It covers the Windows desktop and consists of a few buttons that give access to the most needed actions, e.g. starting the master or client software, opening the Windows Explorer (File Browser).

The PB Menu includes another software called the [VNC Remote](#)<sup>860</sup>, or simply Remote. With that software you can establish a VNC connection to another computer that is in your network. The other computer needs to have a VNC client running to pick up the connection. If there, PB Menu is started, it automatically does this for you. You enter the according IP address and see the desktop of that computer. Now you can click your local mouse and use the local keyboard to interact with the remote desktop.

## Product Structure

The following product structure was introduced in May 2016 with version 5.10.

Pandoras Box Server and Software Player Version 5.x "LT" and "STD" as well as the "Manager LT" purchased earlier are supported and provided with free software updates for one year. Existing features or software restrictions are not altered. Please contact your distributor in case you are interested in upgrading your products to the new product structure.

In case you purchased a "PRO" version or "Manager STD" you might notice that some features were upgraded to meet the figures listed below.

The products "Server", "Player" and "Compact Player" include hardware. We offer three to four editions (Light to Ultimate) defining the size of memory and in case of Servers the CPU and RAM. The number of physical outputs is defined through the graphics card, for the time being that is four Display Port outputs. The number of Output layers is defined with the software, e.g. with a Server Single Output you will have access to the parameters of one Output layer.

Below, you see that all hardware models can be purchased with zero (software) outputs, this is of interest for applications with backup systems or in case you like to use them for Pandoras Box software products. In other words, for the software products EDU Server (Educational version), Software Player, Manager, Manager Offline and Widget Designer you have the choice of using your own custom hardware or purchasing additional hardware from us.

The Software Player is a Multi-License product, meaning that multiple licenses multiply some features, e.g. the number of Layers or Sequences. When you start the software, it will automatically recognize how many licenses are available on your hardware and start in the according Multi-License mode. This applies in case you use multiple dongles or in case you purchased one single dongle with multiple licenses.

	Show Control and Playback Solution				
	Server		Player		
	Server	EDU Server <sup>6*</sup>	Player	Compact Player <sup>4*</sup>	Software Player
<b>Hardware / Software</b>	Hardware + Software	Software	Hardware + Software	Hardware + Software	Software
<b>Software Model - Output Layers</b>	Zero - 0 Single - 1 Dual - 2 Quad - 4	Dual - 2	Zero - 0 Single - 1 Dual - 2 Quad - 4	Zero - 0 Single - 1 Dual - 2	Single - 1 <sup>3*</sup>
<b>Base Parameters</b>	3D	3D	2D	2D	2D
<b>Video Playback</b>	max. 16k	max. 16k	max. 4k	max. 4k	max. 4k
<b>Video Layer</b>	Unlimited	Unlimited	8	4	4 <sup>3*</sup>
<b>Graphic Layer</b>	Unlimited				
<b>Audio Tracks</b>	Unlimited	Unlimited	8	4	4
<b>Effects / Layer</b>	Unlimited	Unlimited	8	4	4 <sup>3*</sup>
<b>Particle Sys. / Layer</b>	Unlimited	Unlimited	8	4	4 <sup>3*</sup>
<b>Warping, Keystone, Softedge, Matrix</b>	Yes				
<b>Network Sync</b>	Yes				
<b>Sequences <sup>5*</sup></b>	Unlimited	Unlimited	4	2	1 <sup>3*</sup>
<b>Mpeg2 Encoder <sup>5*</sup></b>	Included	Included	Optional	Optional	Optional
<b>StreamiX Inputs <sup>5*</sup></b>	32	32	8	4	4
<b>Input Recording <sup>5*</sup></b>	Yes	Yes	No	No	No
<b>Media Encryption <sup>5*</sup></b>	Decryption	De- and Encryption	Decryption	Decryption	Decryption
<b>Playlists <sup>5*</sup></b>	Yes				
<b>Web Browser <sup>5*</sup></b>	Yes				
<b>Hardware Model - Redundant SSD (in GB)</b>	LT - 480 STD - 1440 PRO - 2880 ULT - 5700		LT - 480 STD - 1440 PRO - 2880 ULT - 5700	LT - 480 STD - 1440 PRO - 1900	
<b>Form Factor</b>	4U 19" Rack		4U 19" Rack	1U ½ 19" Rack	
<b>Video Input</b>	None, DVI, HD/3G SDI *		None, DVI, HD/3G SDI <sup>2*</sup>		DirectShow only
<b>Audio Output</b>	None, 1x/4x ADAT or MADI		None, 1x/4x ADAT or MADI		
<b>Framelock / Sync</b>	Optional		Optional		
<b>10Gb Ethernet</b>	Optional		Optional		
<b>Optional Accessories</b>	DVI Processor SDI Processor		DVI Processor SDI Processor		

	Show Control Solution			Interactivity Solution	
	Manager			Widget Designer	
	Manager	Offline Manager			
<b>Hardware / Software</b>	Software	Software	<b>Unlimited Web Clients</b>	Optional	
<b>Audio Tracks</b>	16, optional unlimited	Unlimited			
<b>Network Sync</b>	Yes	No			
<b>Sequences</b>	8, optional unlimited	Unlimited			
<b>Mpeg2 Encoder</b>	Yes	Optional			
<b>Input Recording</b>	Yes	No			
<b>Media Encryption</b>	De- and Encryption	Decryption			
<b>Playlists</b>	Yes	Yes			
<b>Optional Accessories</b>	Jog Shuttle Fader Board SMPTE Link DMX Link		<b>Optional Accessories</b>	Jog Shuttle Fader Board SMPTE Link DMX Link	

- \* A maximum of 2 input boards can be configured
- 2\* Only 1 input board can be configured
- 3\* Count multiplies with number of Multi-Licenses
- 4\* Expected 2016 Q4
- 5\* Available in show control mode
- 6\* The Education edition is available only to universities and schools with an approved education contract

Date: May, 2016. All information contained in this document is subject to change without prior notice.

## 4.2 How to connect via VNC Remote

This is the screen you start with. What you see is called the PB Menu. If you like to access another computer, click the "Remote" button.



You will see a an image, while you wait for the Remote window to open.

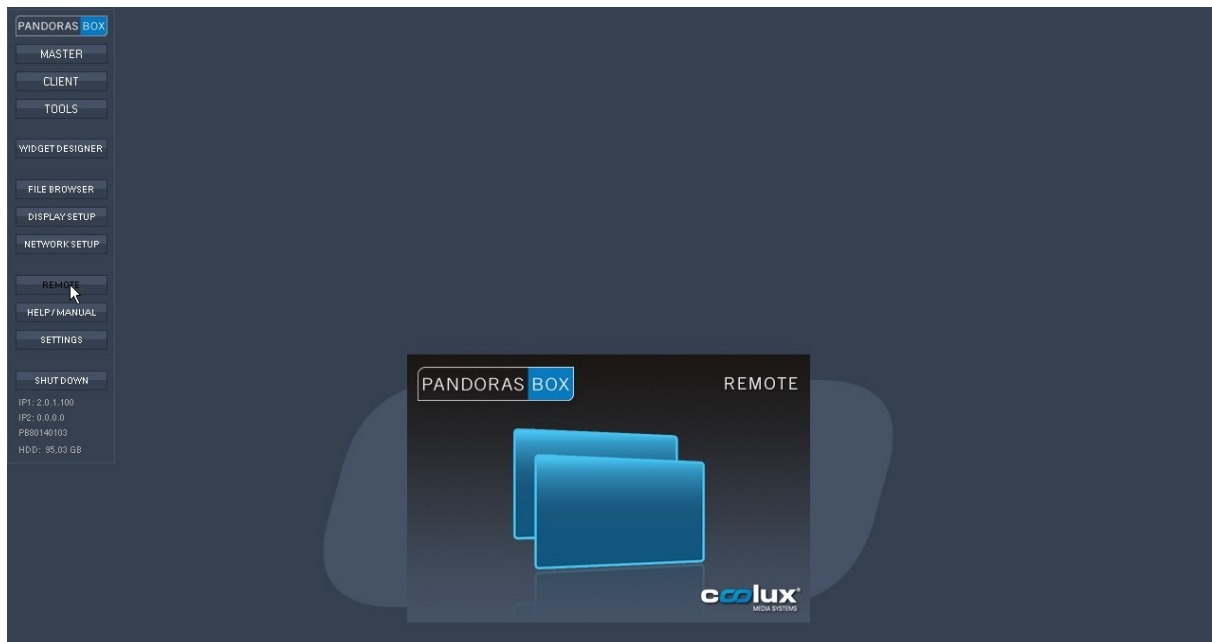

Now, you see the interface from the Remote tool. With that software you can establish a VNC connection to another computer that is in your network. The other computer needs to have a VNC client running to pick up the connection. If PB Menu is started on that computer, it automatically did this for you. Now, you can enter the according IP address in the "VNC" text field.

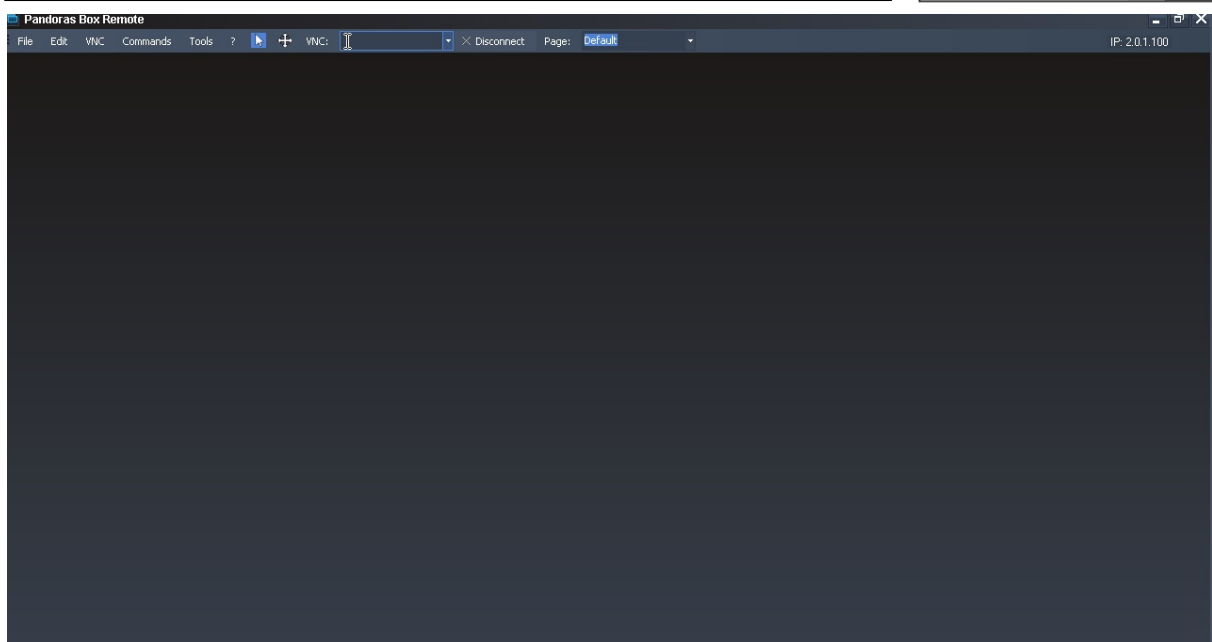

Now VNC Remote tries connect. If the connection cannot be established, check:

- if you entered the correct IP address
- if the computer is in the network
- if the network is OK, e.g. by pinging the computer

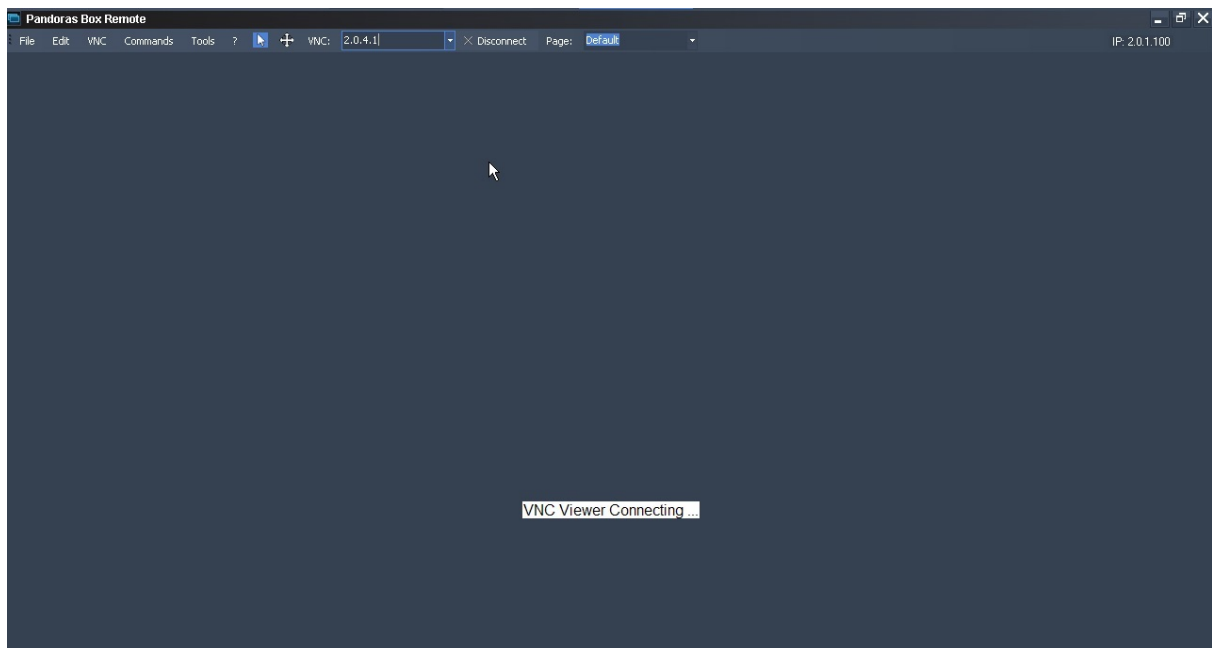

When the connection is established, you see the desktop of that computer. Click your local mouse and use the local keyboard to interact with the remote desktop.

If you connected to client computer that renders in fullscreen, you might want to leave fullscreen: click into the window and then use the shortcut keys: CTRL + F

If you connected to a Win7 client that renders in fullscreen, you do not see the fullscreen, even though it is there. Instead you see the desktop underneath it. You will notice that you cannot click something in the desktop. Do the above steps, click in the Remote window and use CTRL + F and you will see the small rendering window.

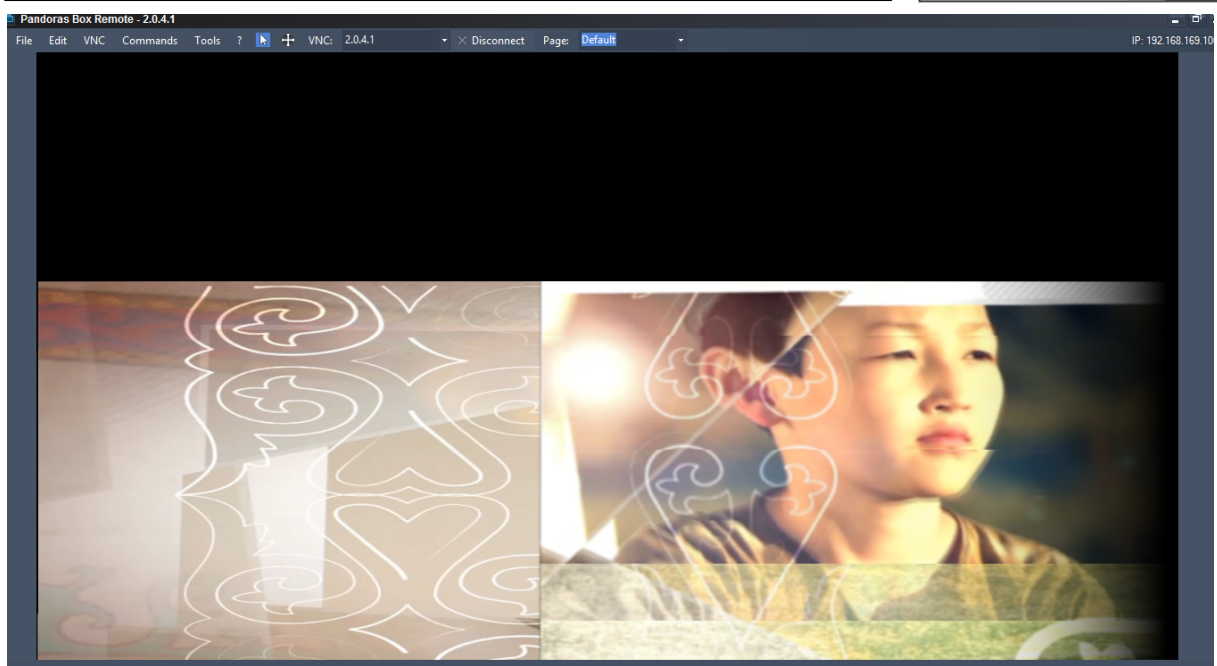

Above you see the fullscreen rendering and after CTRL + F the small rendering window.



If the client does not render anything, for example because the content was not spread, it looks like this. How to spread content is explained in the chapter "[Basic steps](#)"<sup>[89]</sup>. If there are problems, also check, that "Master IP" displays the correct IP and not the words "Not connected"

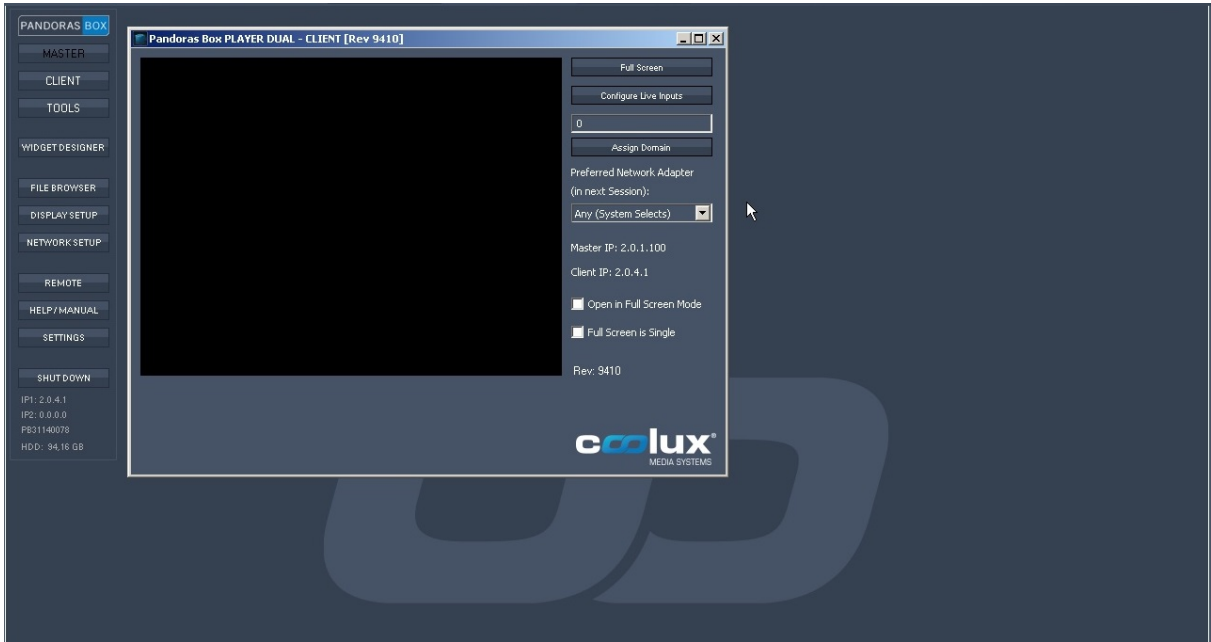



### 4.3 How to see the taskbar

This is the screen you start with. What you see is called the PB Menu. It hides the taskbar. If you like to see it, click the "Settings" button.

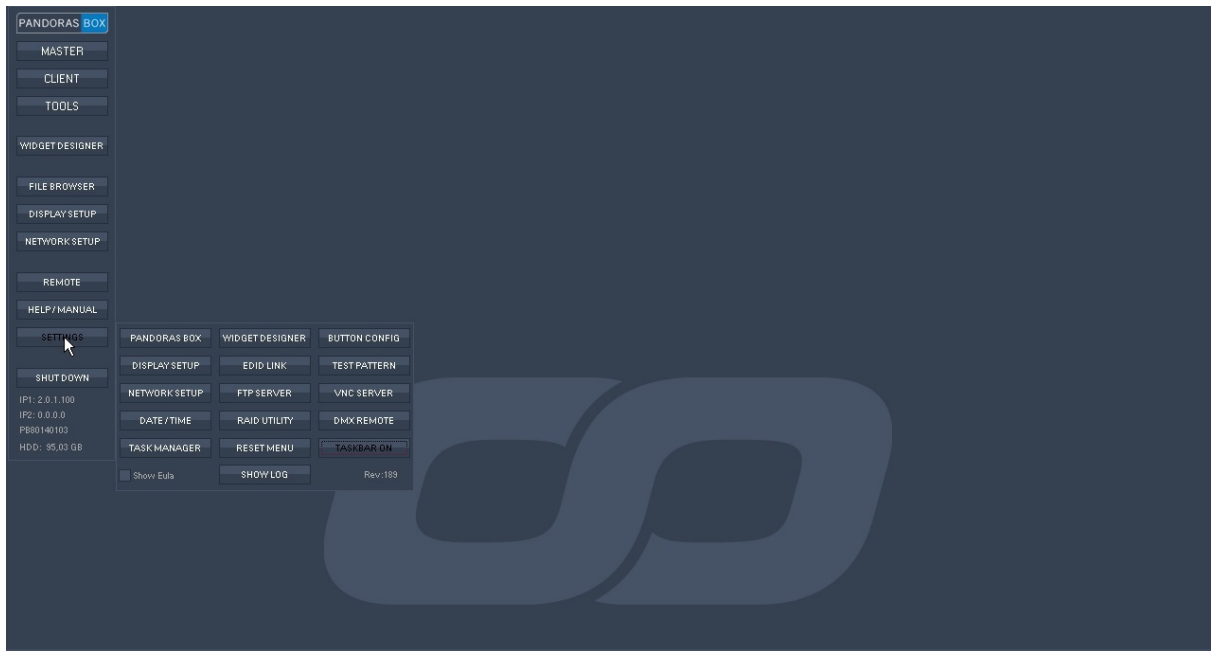

Then click on "Taskbar On".



### 4.4 How to ping other computers and check your IP and MAC address

This is the screen you start with. What you see is called the PB Menu. It hides the taskbar. To see it, click the "Settings" button and then the "Taskbar On".

Now click the Windows Start button and choose "Run...".



Enter the below code and click OK:

cmd

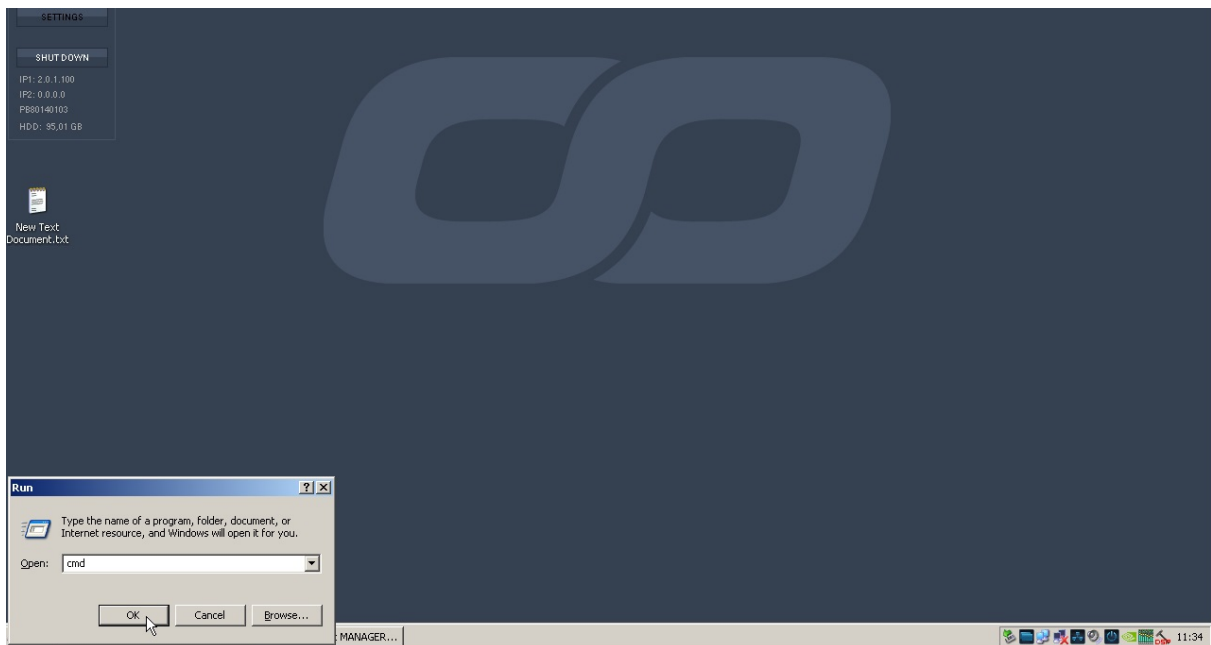

The Command Prompt window opens. Simply write (behind the already existing entry) the below codes and hit the Enter key.

In order to ping another computer in the network, write "ping " and the IP address. If the ping goes through it looks like the below image.

Enter for example:

ping 2.0.4.1

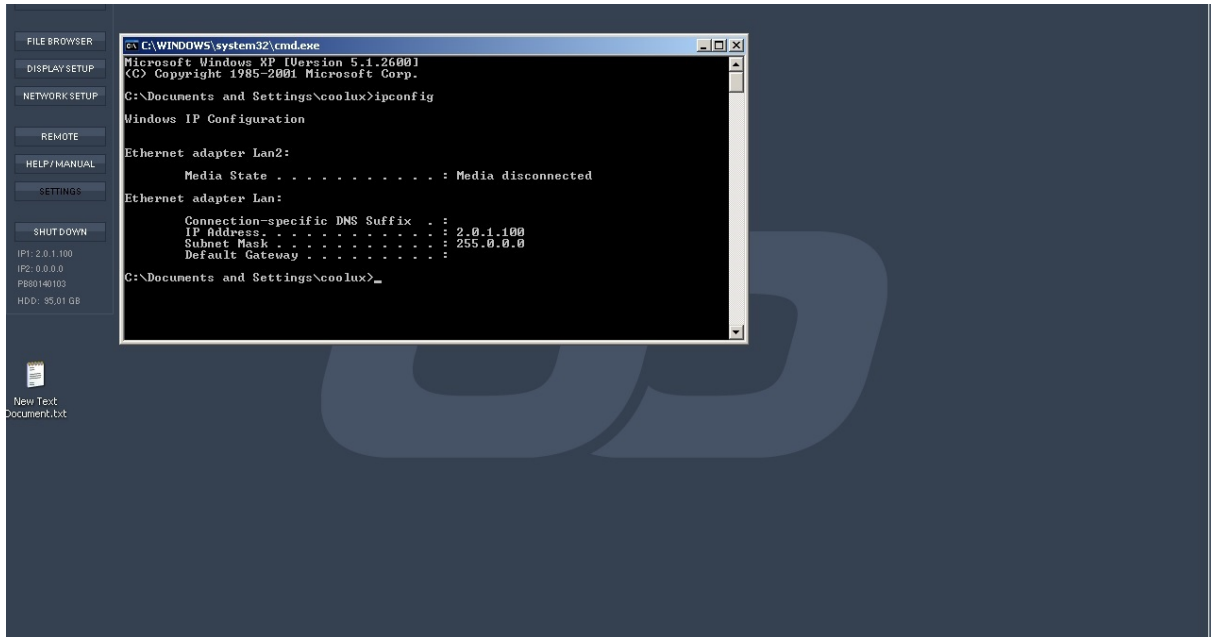
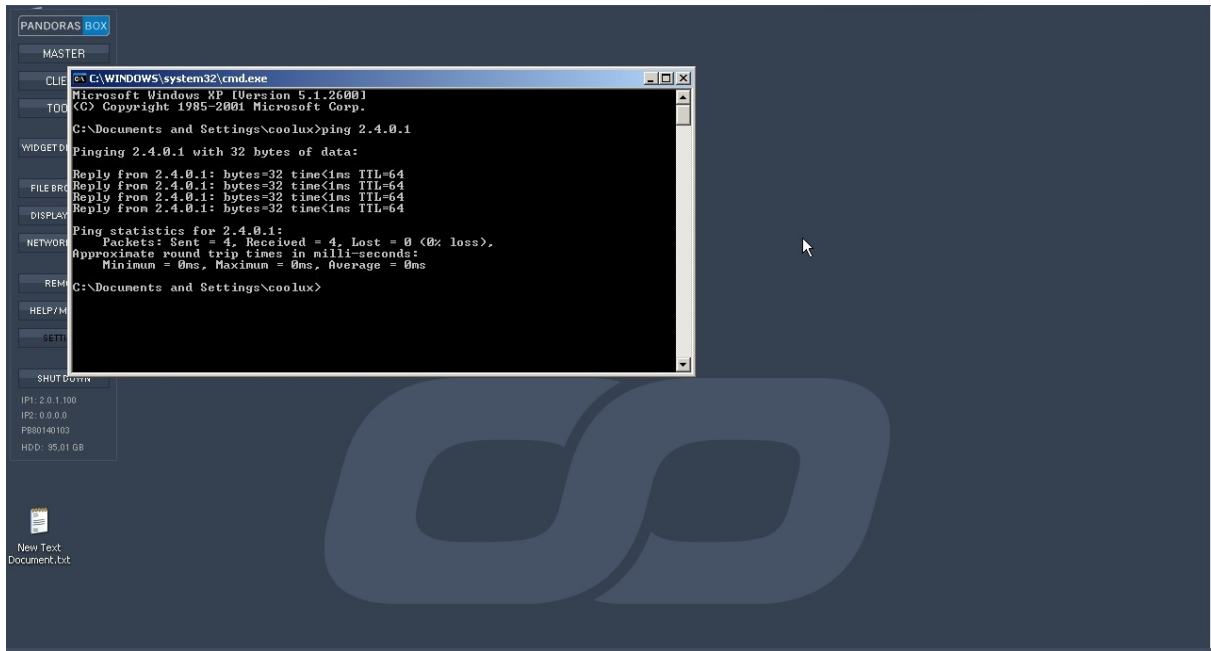

If the ping request is not successful, there is either:

- a fundamental network problem (loose or broken cables, overloaded or broken switches or other connected devices)
- an IP conflict with other devices, for example because other devices have the same IP address (check all IP addresses within the Windows settings or with the PB Menu button "Network Setup" or the command in the below image)
- the entered IP address is wrong. The answer takes then longer and says for example "host not available"
- entered text is wrong, check that you have not forgotten to write "ping", that there is a space and that the numbers are separated with dots

In order to check what your own IP address and the MAC address, enter:

ipconfig

For more advanced results:

ipconfig /all

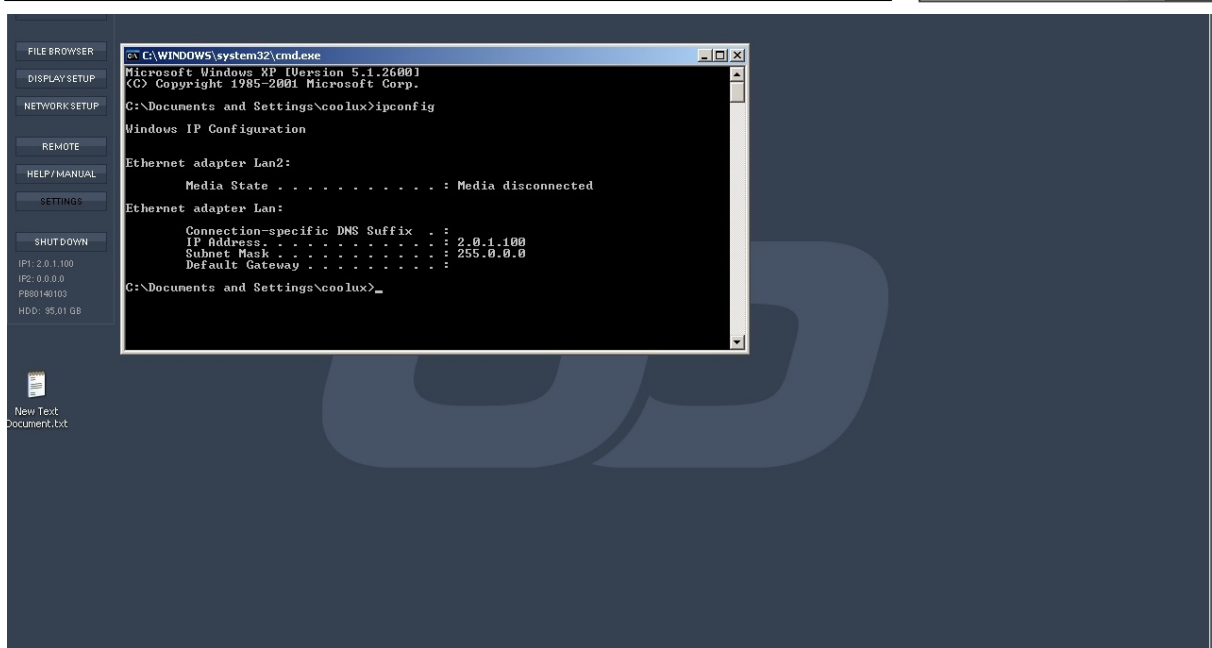

## 4.5 How to check and change the resolution

This is the screen you start with. What you see is called the PB Menu. If you like to check the resolution or need to change it, click the "Display Setup" button.



Now you see the NVIDIA Control Panel (or another window if another graphics card is used). To check the current resolution, or in order to change the resolution, click on "Change resolution". For other settings, see [this chapter](#)<sup>675</sup>.

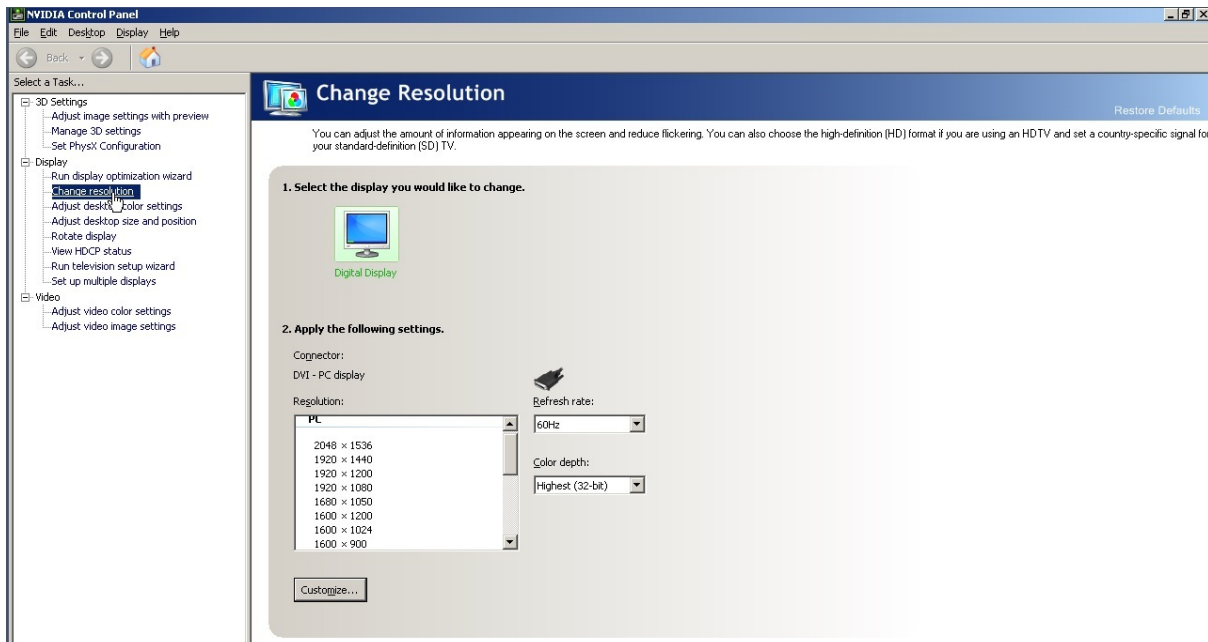

### 4.6 How to access log files

This is the screen you start with. What you see is called the PB Menu. If you had problems and the technical support asked to receive your log files, first of all you need to connect to the computer you had problems with. That means, if it was a client, first connect to it. These steps are described in the chapter "[How to connect via VNC Remote](#)"<sup>69</sup>.

Now, click the "Settings" button and then the "Show log" button.

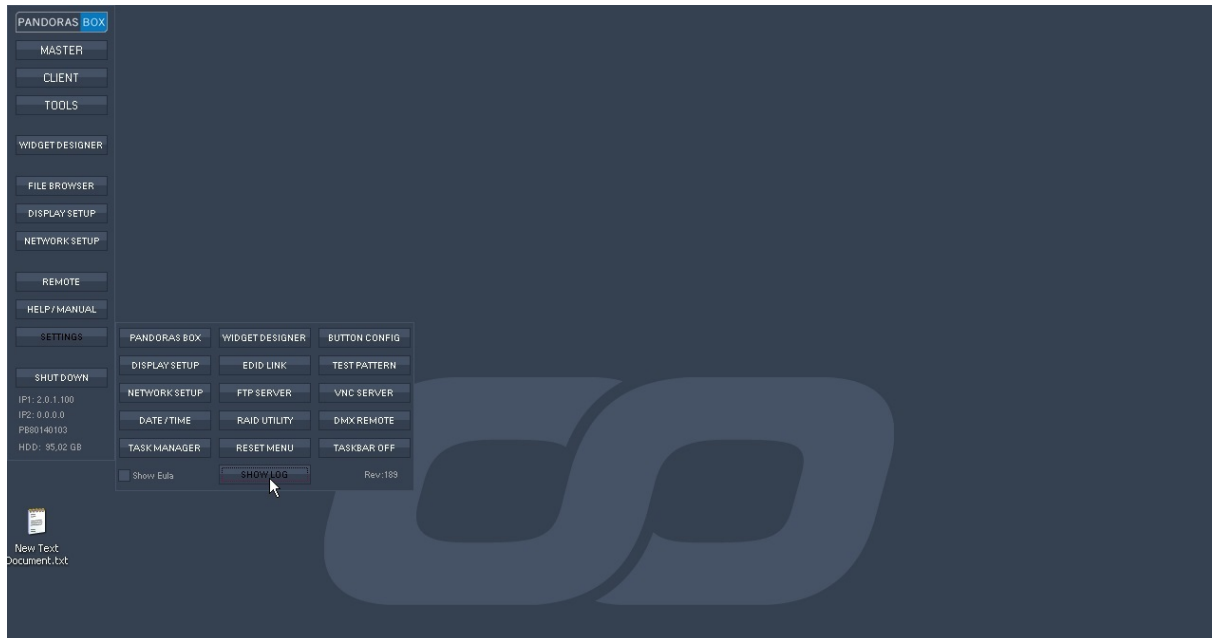

You see the Windows Explorer with the according Logs folder.

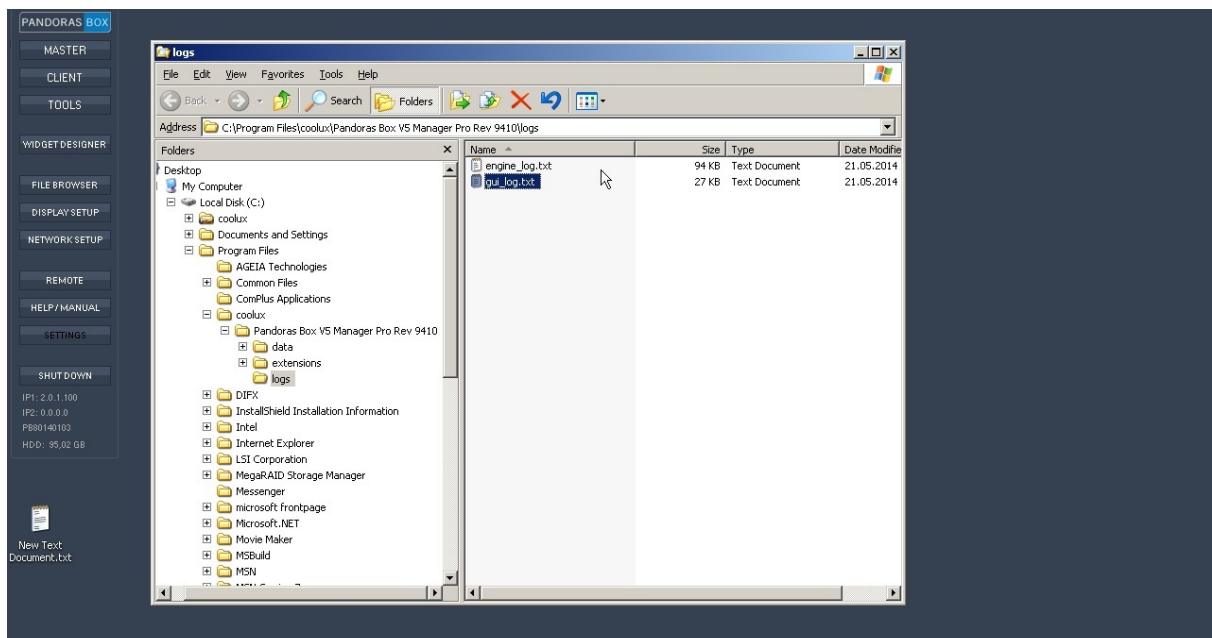

Take all files that you see and mail them all to the technical support.

You might need to do that for the Manager as well as for the clients (Players and Servers). If yes, enable a VNC connection to the client as described in the chapter "[How to connect via VNC Remote](#)"<sup>69</sup>. Then

do the above steps to enter the logs folder. In order to copy them through the network to your local machine, open a second browser. In there, you enter two backslashes and the IP address, e.g. \\2.0.1.100

Then you can make a new folder, in our example it is called "files to be copied to USB stick" and copy the files from the client to that folder.

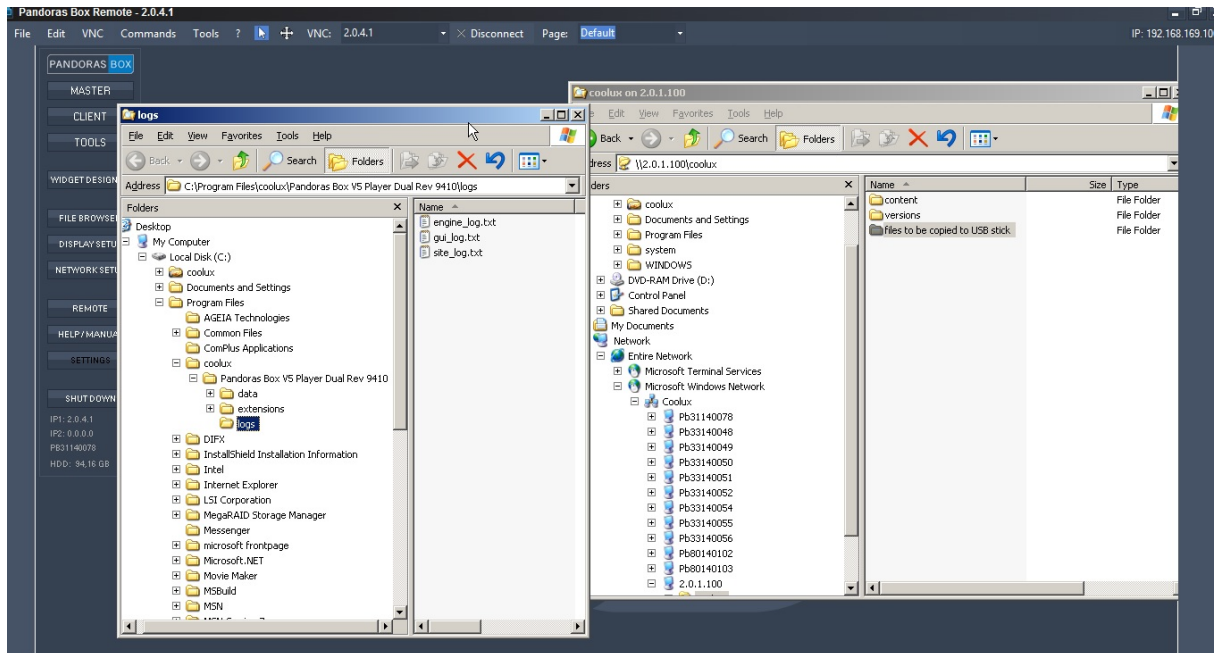

Afterwards you close the VNC Remote tool again, and back on your local PC you can then copy the files to an attached USB stick and transfer them to a PC that is online and send a mail to coolux support.

## 4.7 How to install a new Pandoras Box version

If you need or wish to update your current Pandoras Box version, you first of all need to download the new installer. To do so, go to [coolux.de](http://coolux.de) > Support > Download-Center and log in with your user account settings. If you have not registered, please do so, it will only take a minute. Click on the link for the new version to start the download.

Copy the installer file to all (!) computers that run Pandoras Box. That applies to the Manager as well as all Players and Servers. Please read the chapter "[How to copy files from and to a remote PC](#)"<sup>82</sup>.

Run the installer on each computer.

Then, you need to tell the PB Menu to start the newly installed version when clicking the Master and Client button. If you do not do that, the buttons will start the old version. So please click on "Settings" and "Pandoras Box".

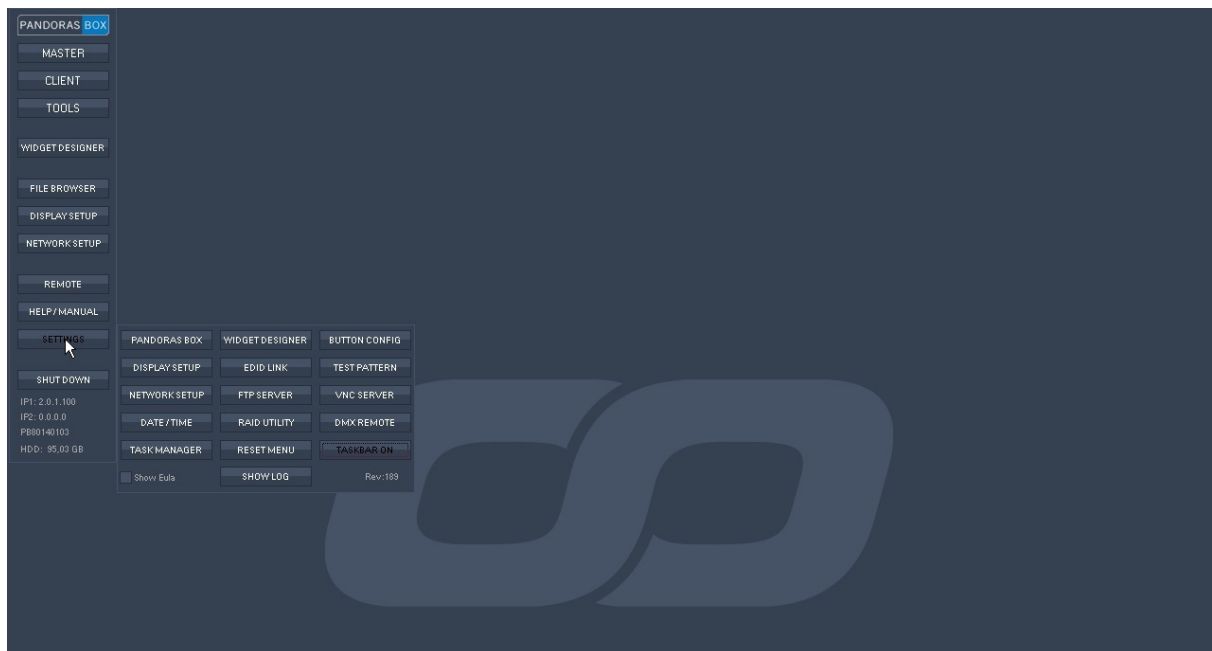

A dialog opens where you can see all already installed versions of Pandoras Box. Pick the newest version and press "OK".



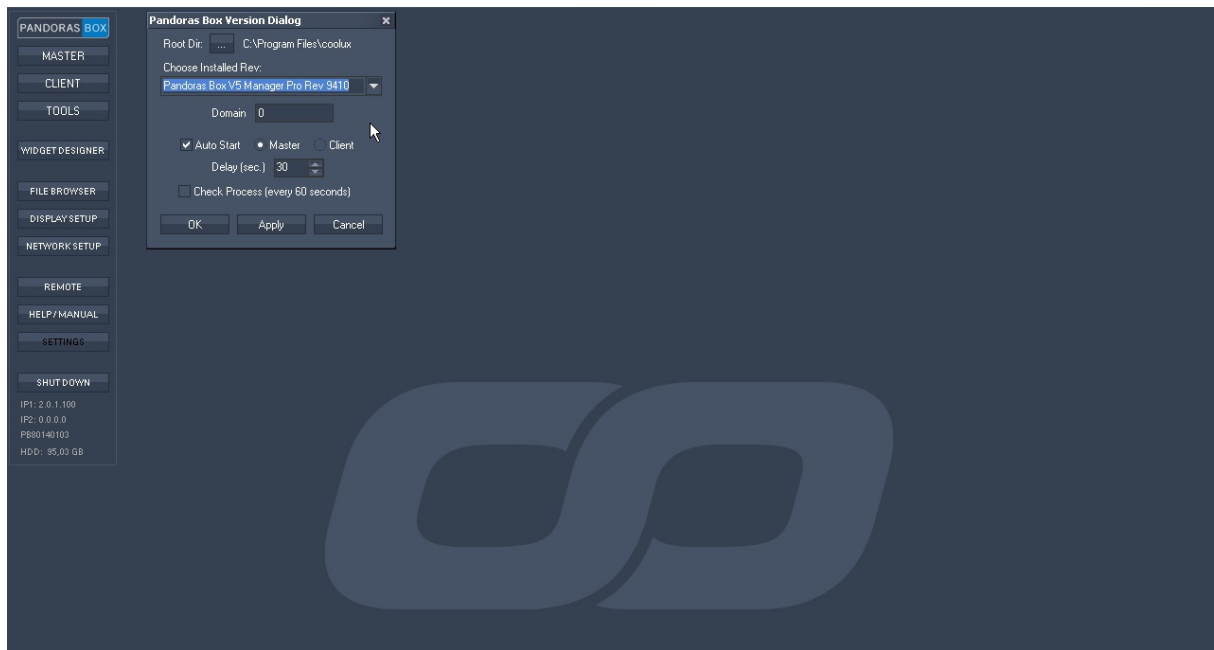

## 4.8 How to copy files to a remote PC

This is the screen you start with. What you see is called the PB Menu.

This explains how to copy files to a remote PC (e.g. a new installer). Important notice: Do not follow these steps if you simply want to copy content to all your clients. The content spreading and management is done via the PB Master (e.g. the Manager).

Open two Windows Explorers by clicking twice on the button "File Browser".

In order to copy files through the network to a remote computer, enter two backslashes and its IP address. In the example below, the browser on PC 2.0.4.1 copies files to the remote 2.0.1.100, so this was entered in the second browser:

\\2.0.1.100

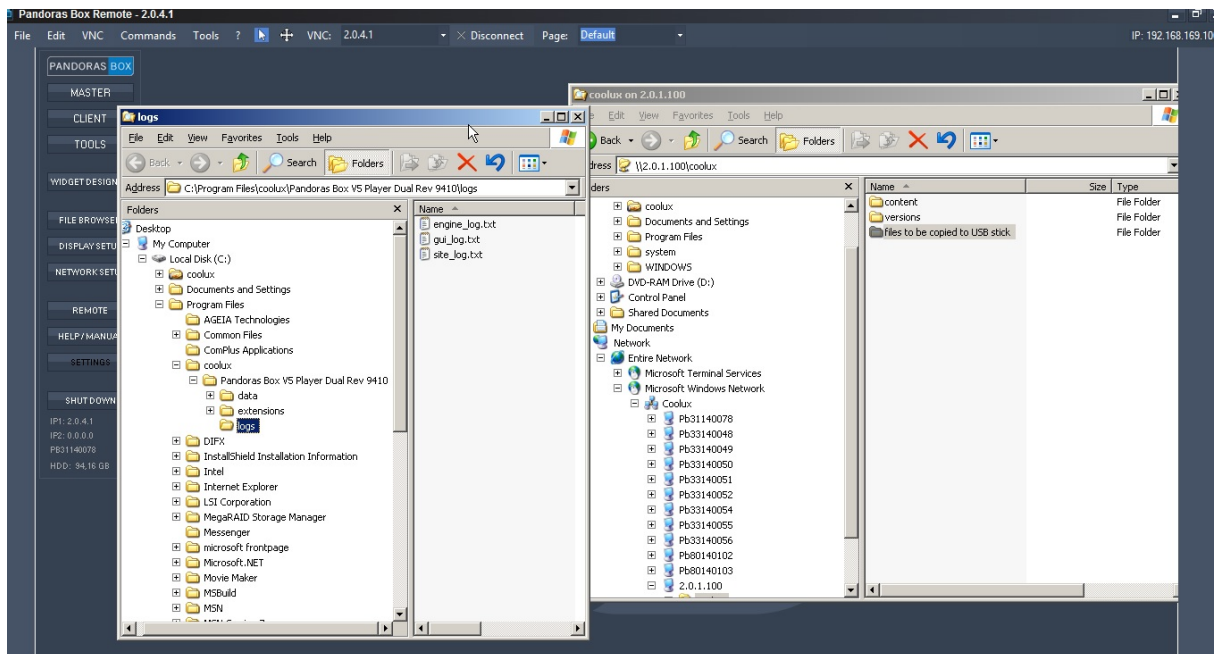

Afterwards you close the VNC Remote tool again, and back on your local PC you can then copy the files to an attached USB stick and transfer them to a PC that is online and send a mail to coolux support.

## 4.9 How to copy content to your hard drive

This explains how to copy files from an external hard disk, e.g a USB stick, to Pandoras Box hardware. Important Note: There is no anti-virus software running and protecting Pandoras Box hardware!! It is highly recommended to check ANY hard drive for viruses BEFORE plugging it in.

This is the screen you start with. What you see is called the PB Menu. To copy files we need the Windows Explorer, so click the "File Browser" button.



In the explorer, go to the drive "Removable Disk".

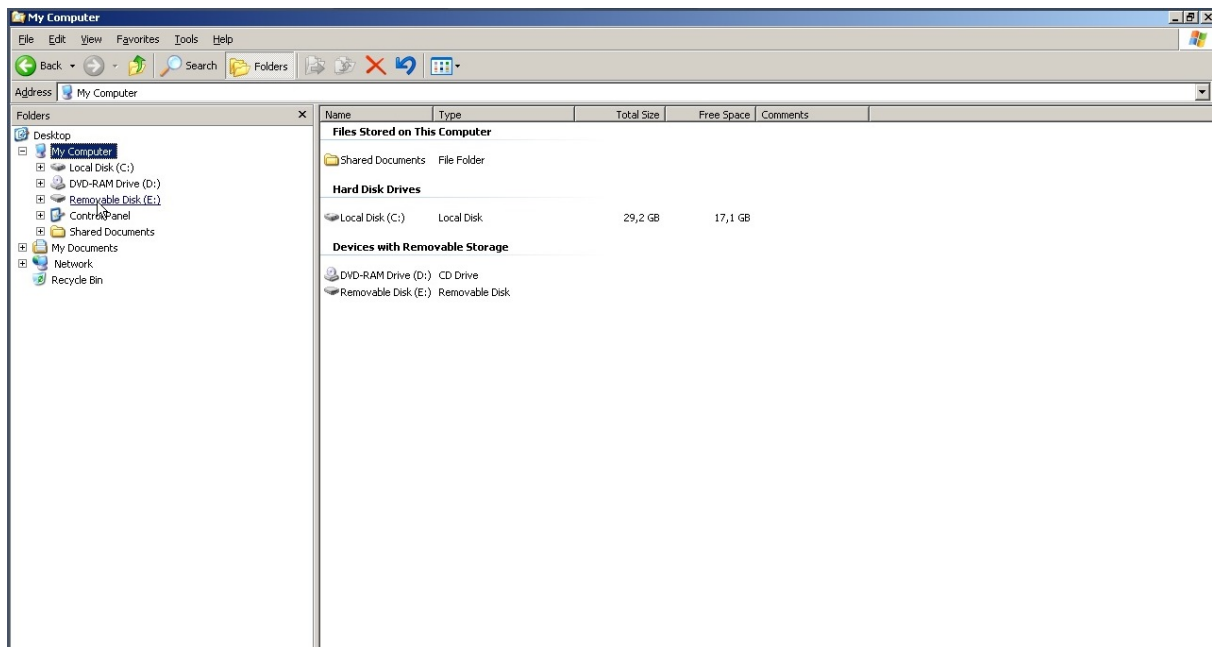

Search for the files you need. Make a right-click on them, and say "Copy". You can also use the short cut CTRL + C.

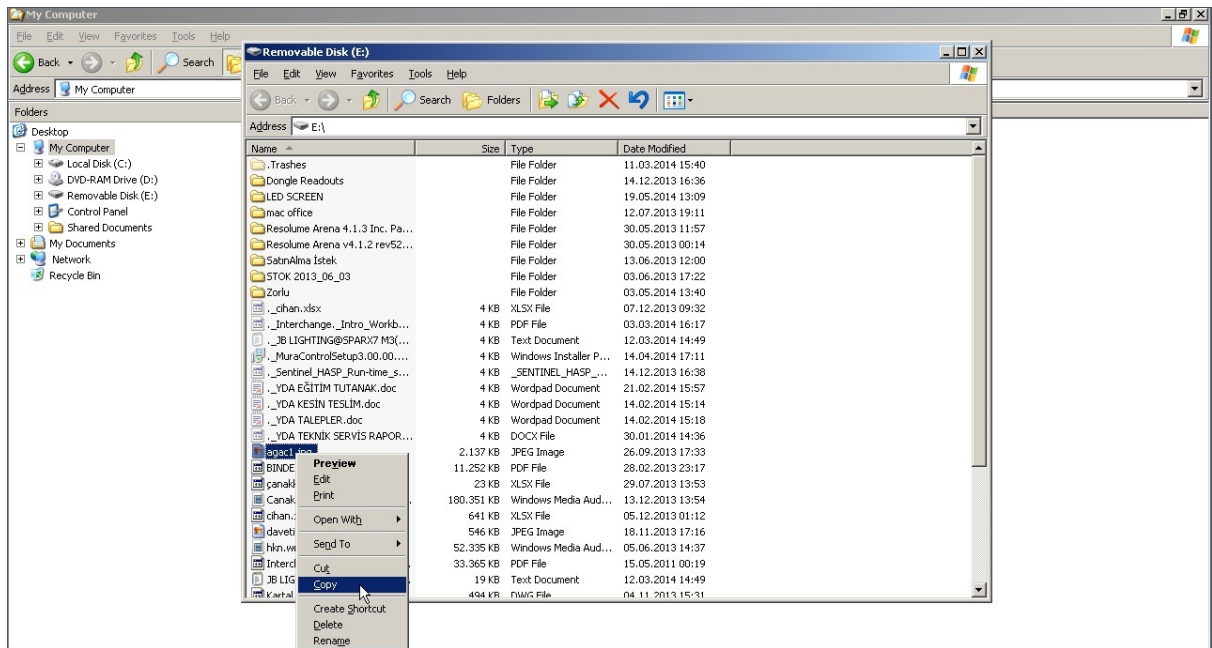

Go back to the "Local Disk (C:)" > coolux > content and the folder that already exists.

OR

Go back to the "Local Disk (C:)" > coolux > content and create a new folder. Choose a good name.

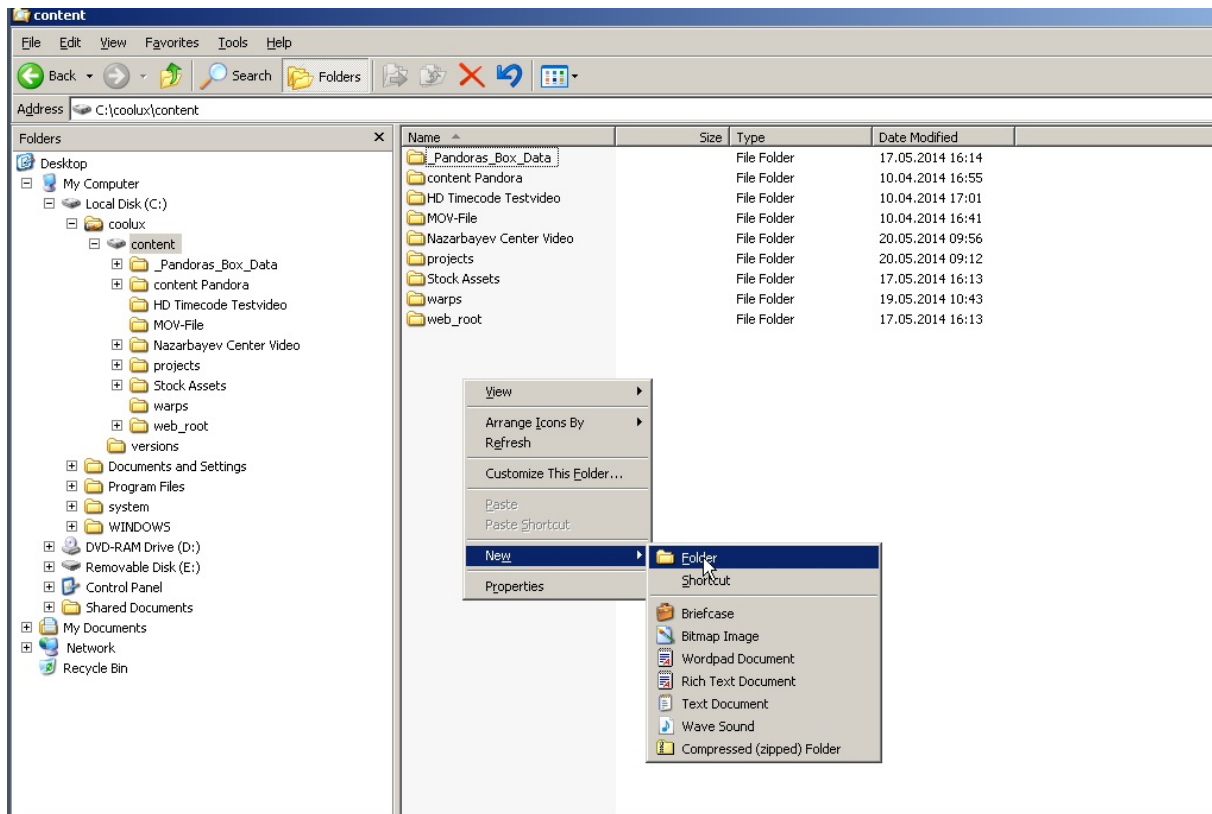

Paste the content into the folder with a right-click and "Paste" and the shortcut CTRL + V.

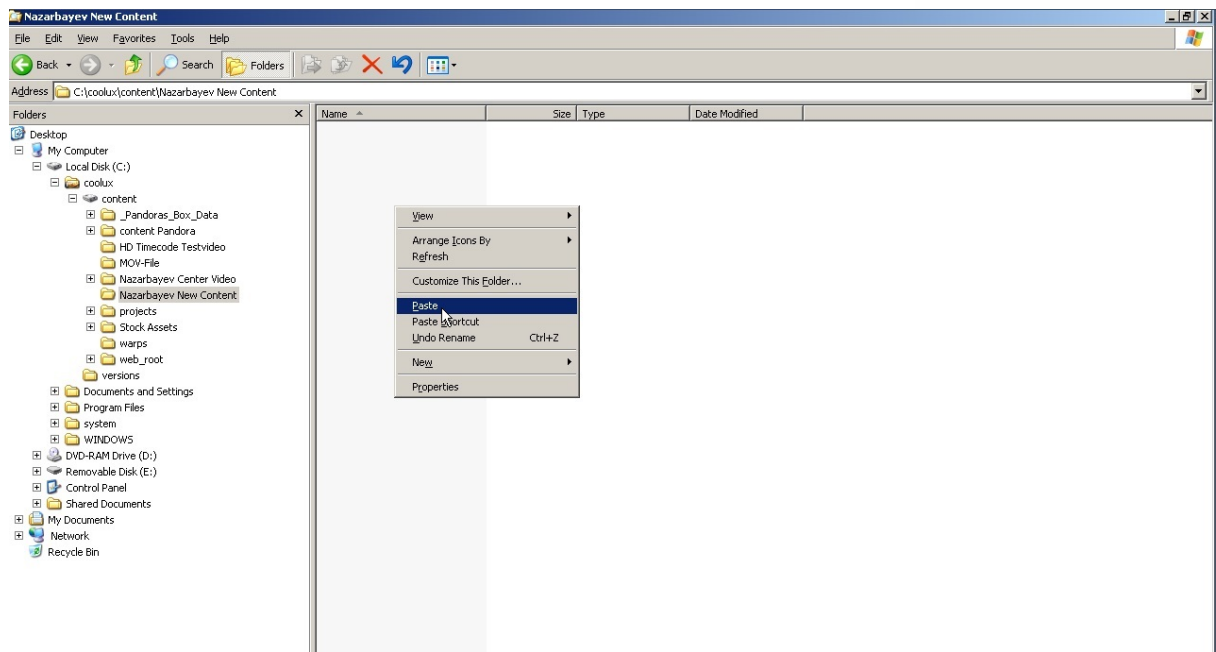

## 4.10 How to copy content to the project

The last chapter explained how to copy content from an external hard disk, e.g a USB stick, to Pandoras Box hardware. Now, it needs to be included in the Pandoras Box software.

This is the screen you start with. What you see is the Pandoras Box Master, in this case a Manager.

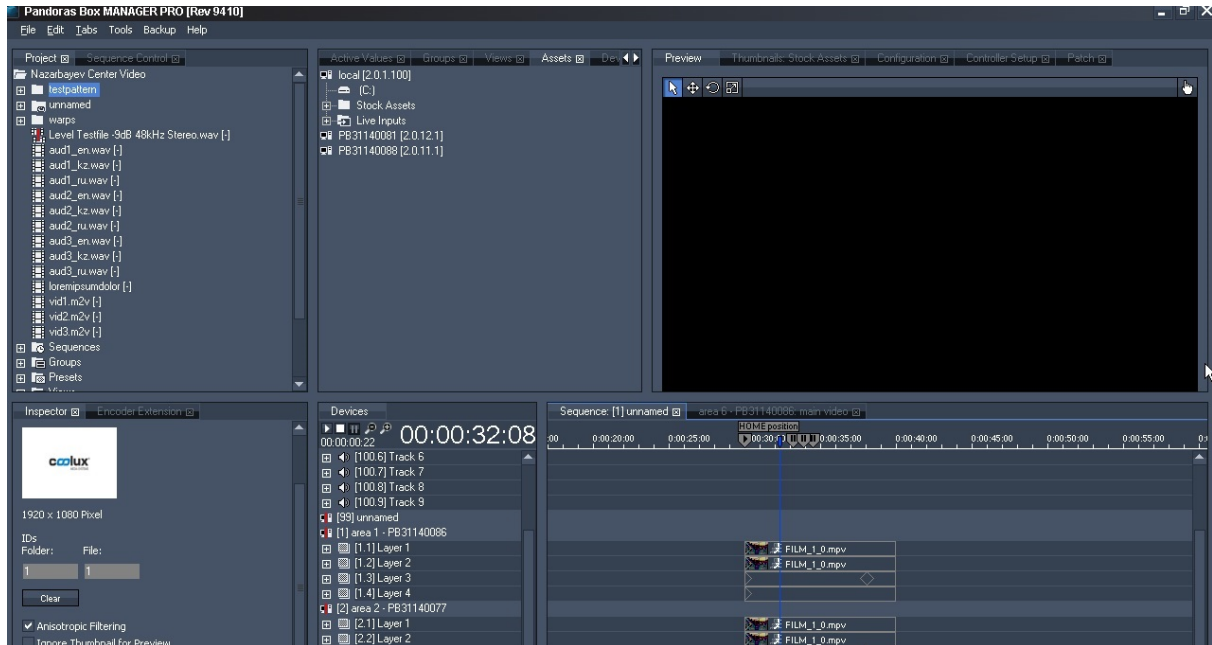

In the "Assets tab" open the C drive from the "local" and then go to the folder you have copied the files to. Mostly, that is C:/coolux/content/...

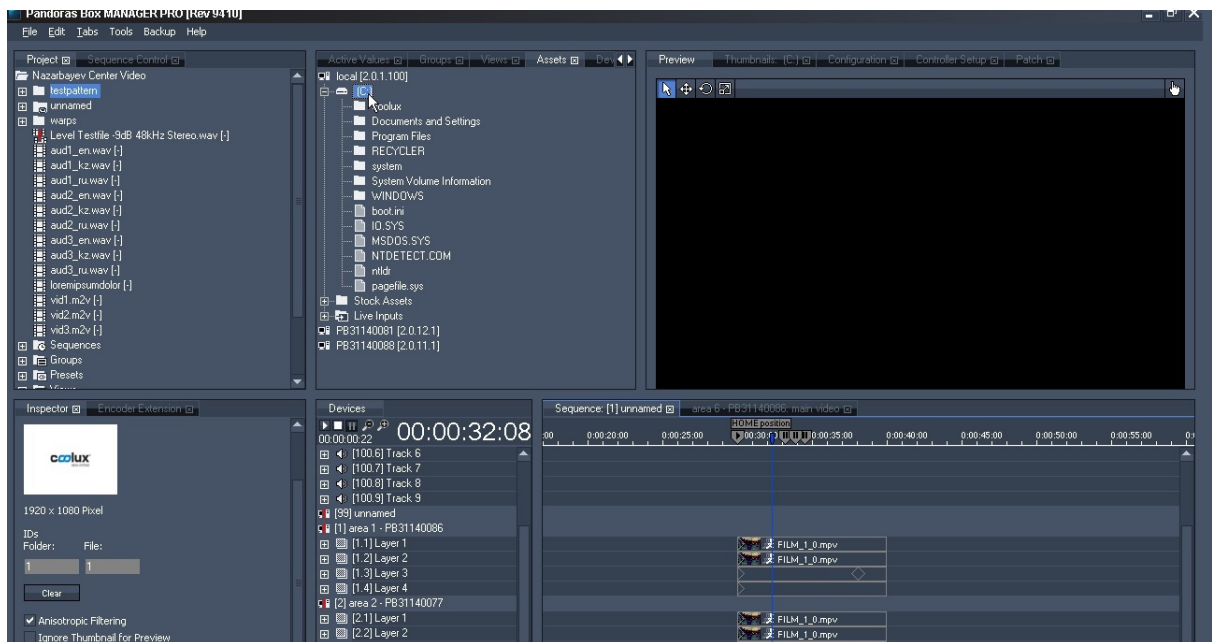

If you do not see the folder, make a right-click and choose "Refresh Drive".

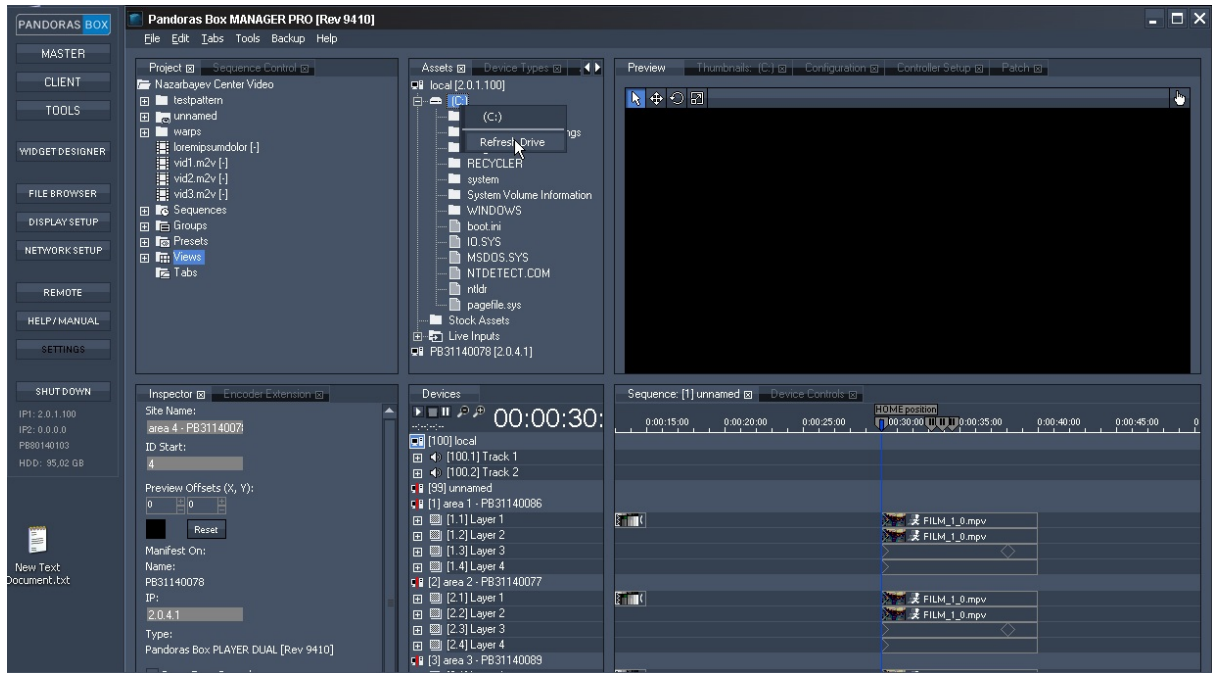

Then drag the folder or single files to the "Project tab" to the project folder you want to have the files in.

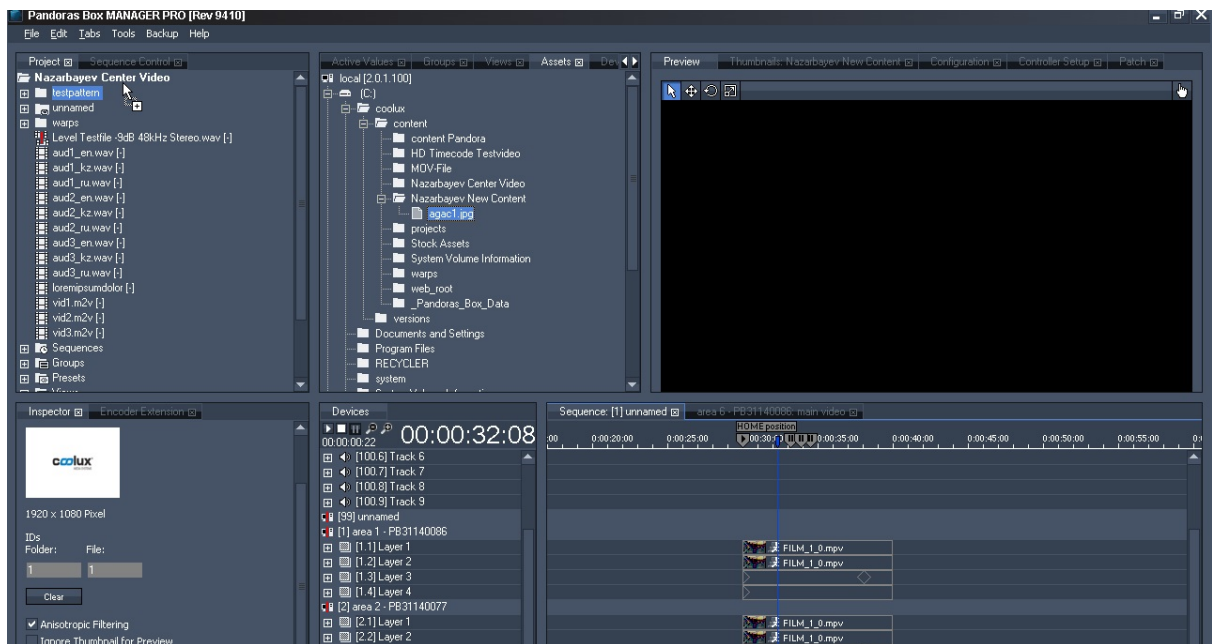

Sometimes you need to Spread the file manually. Spreading means that the Master sends this file to ALL of its clients (Players or Servers). Right-click on the file and choose "Spread".

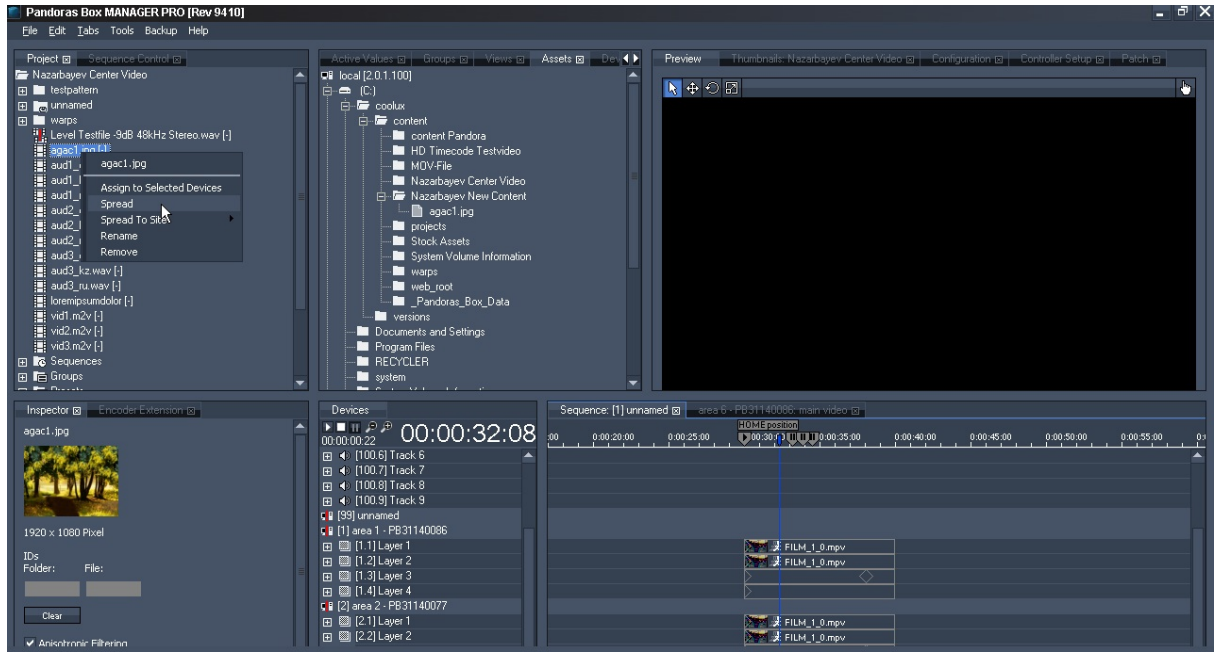



## 4.11 Basic steps in the user interface

This chapter covers the most important tabs and buttons of the user interface to do basic changes.

This is the screen you start with. What you see is called the PB Manager. In the chapter ["How to copy content ... to the project"](#) <sup>86</sup> you have already met the "Assets tab" and the "Project tab".

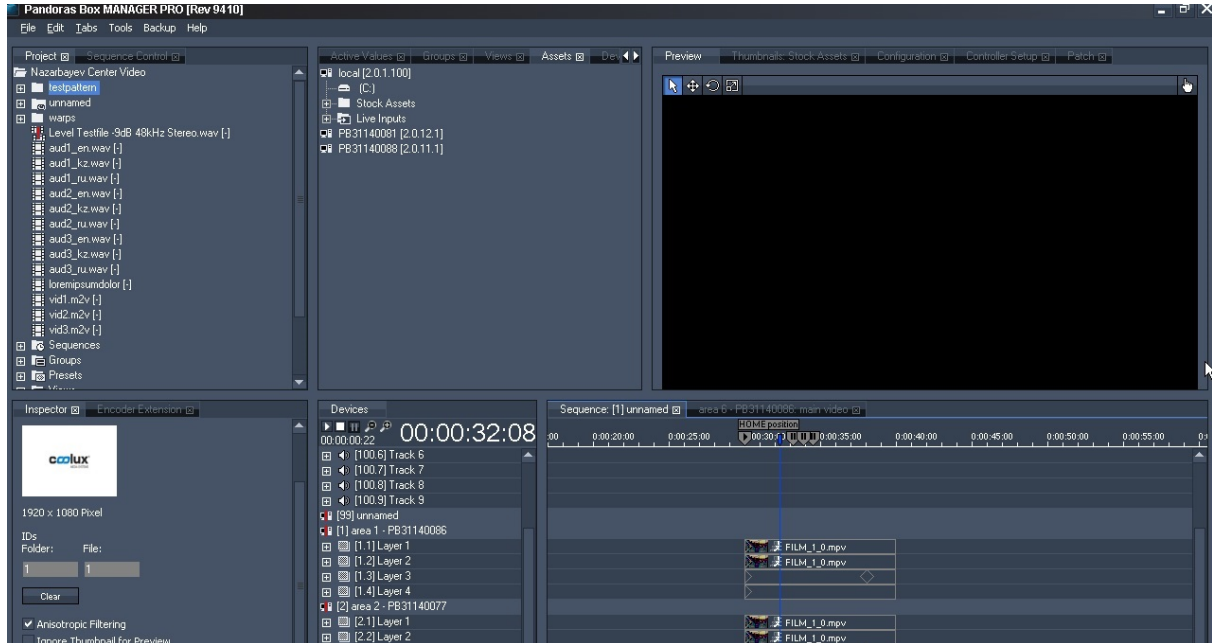

This is the "Devices tab" where you see all clients. The icon displays a red exclamation mark that warns you that the client is not properly connected, e.g. because

- network problems
- wrong IP address (in below picture, the "Inspector tab" shows IP 2.0.1.1. for the selected client "[1] area 1 - PB...")
- client not turned on
- client software not started (no Auto-Start)

If that happens, try to [ping the client](#) <sup>74</sup> or try to [connect to it via VNC](#) <sup>69</sup>.

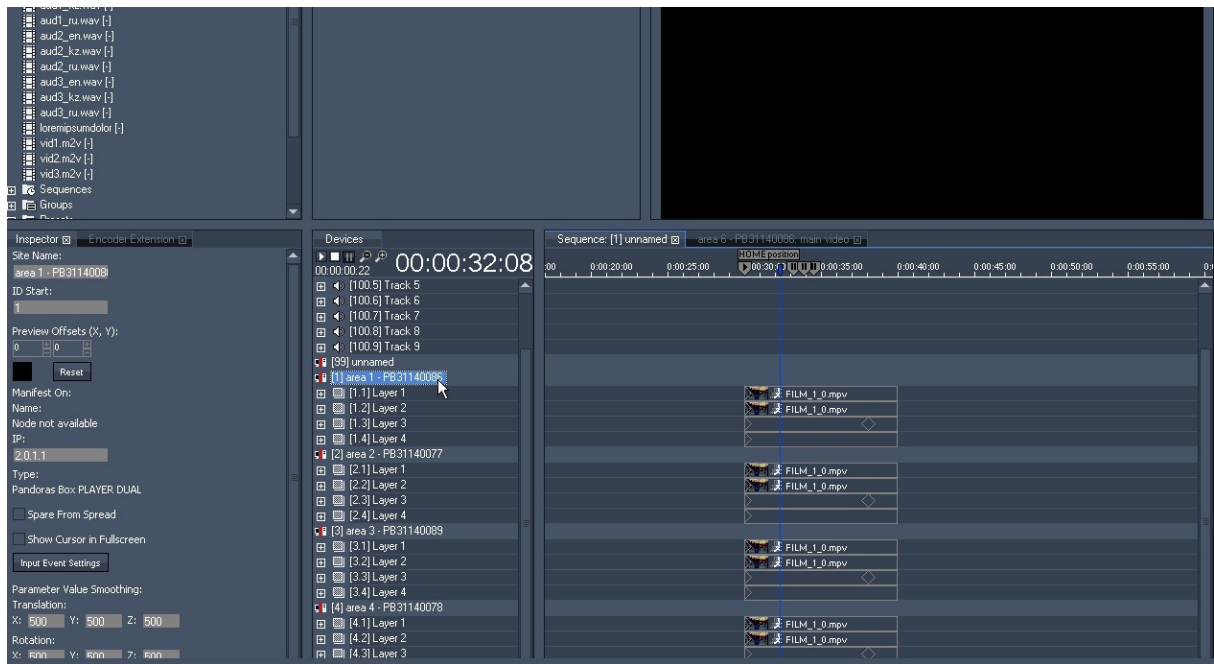

The clients in the "Devices tab" have different layer types. Below, is an example of a Video Layer [1.1] of the selected client "[1] area 1 - PB...". To the right side you see the "Sequence tab" with the according container. The container has stored parameters for the Video Layer. Stored parameters are called keys and are displayed as diamonds.

On top of the sequence there is the time bar with play or pause "cues". On of them is called in the example "HOME position".

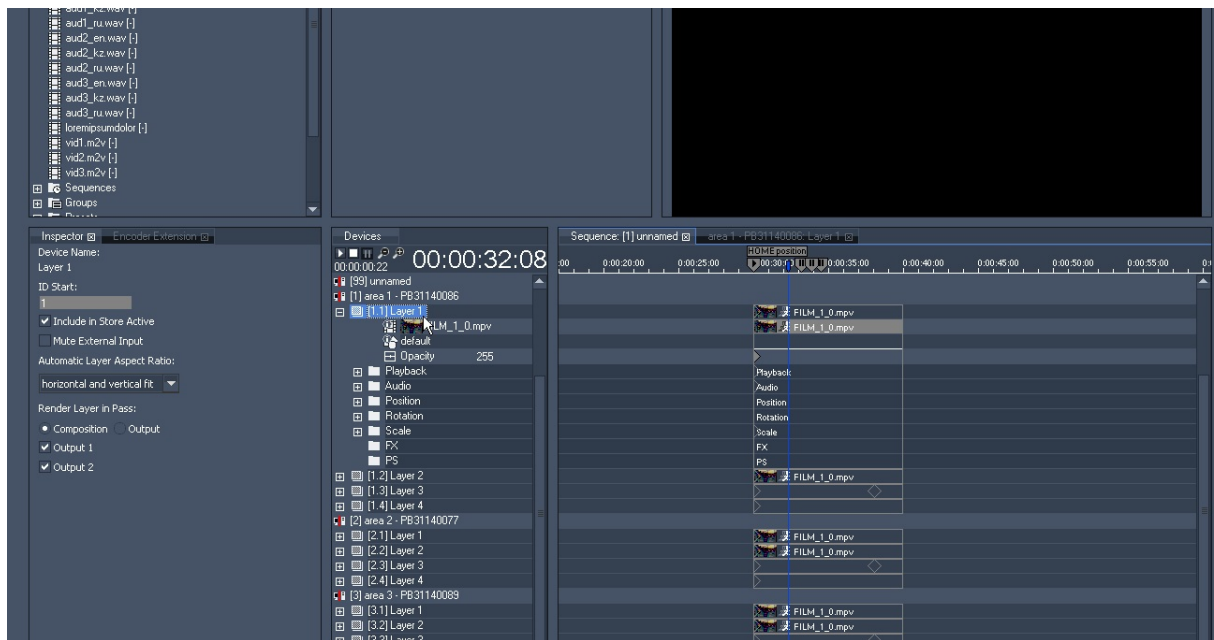

If you need to change the parameters of a Layer, select it and then go to the "Device Control tab" which is right next to the "Sequence tab". Here you see for example the parameter "Media / Mesh". If you need to exchange content, simply drag the file from the "Project tab" onto the media thumbnail.

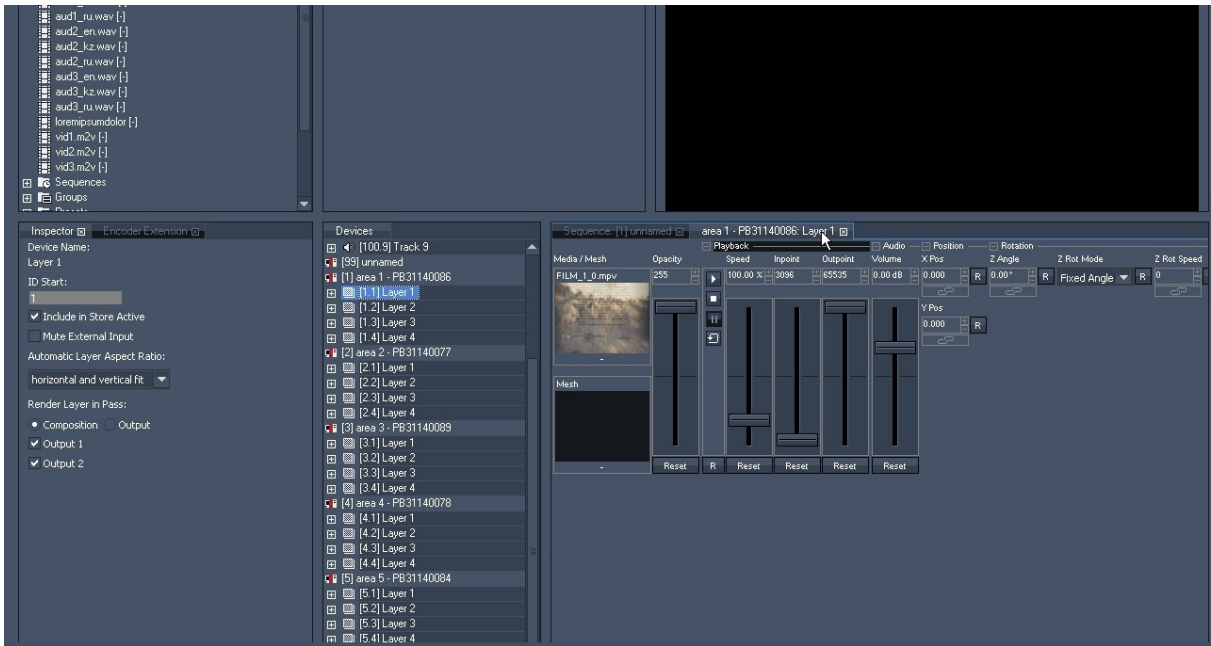

To see what the client renders and what your changes look like, you have the option, to use the "Preview tab" on the top right side. If your client is not seen in there, right-click on it and choose "Toggle Preview". All previewed clients show a blue icon in the "Devices tab".

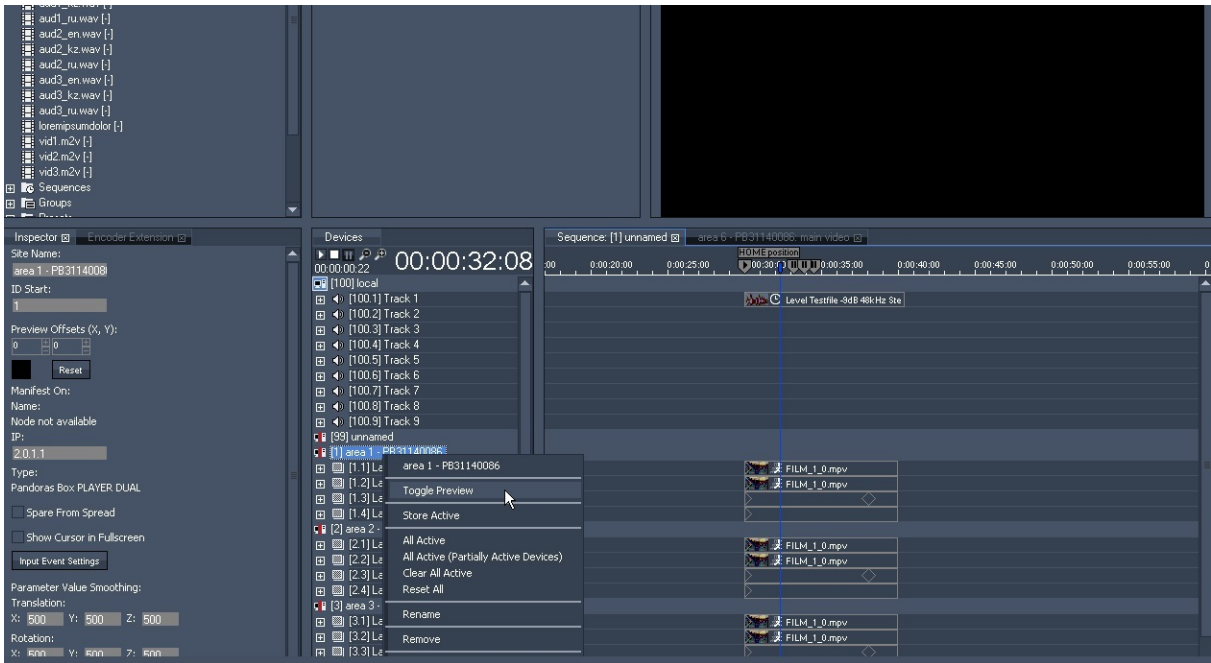

If you stand in front of the display and want to see your changes but the client is only running in the smaller window, you can enter fullscreen in the same menu.

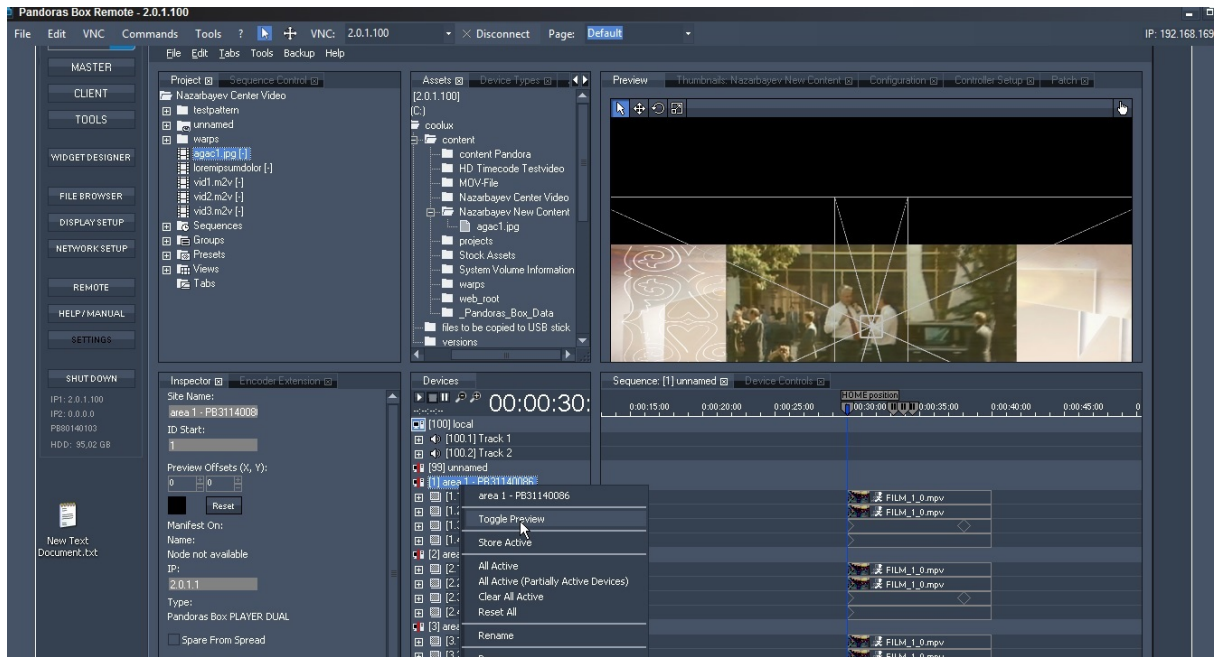

To store your changes, go back to the sequence and choose the time:

- click in the timecode and enter a new number ( 500 means 5 seconds and 0 frames)
- drag the blue line (now pointer) by clicking in the time bar
- use the shortcut CTRL + ALT + "left arrow" to move in front of a container

Right-click and say "Store active". You can do the right-click on:

- the time bar
- a client
- a layer
- a parameter

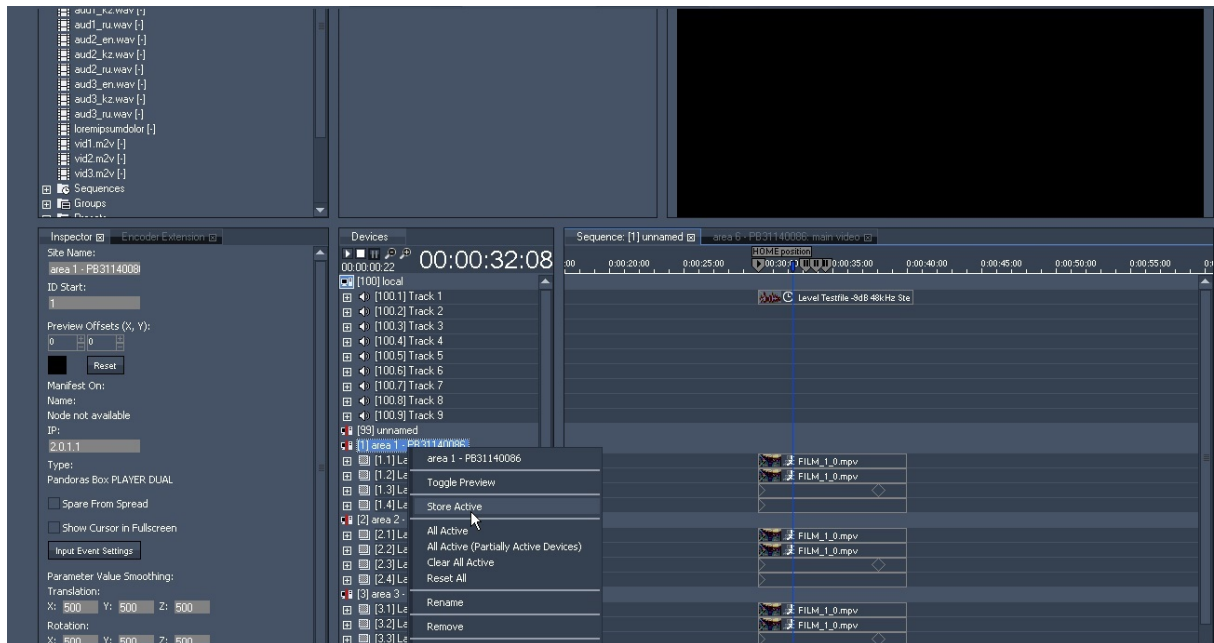

When you make changes like these, you might want to save your project. To do that, click "File" > "Save project".

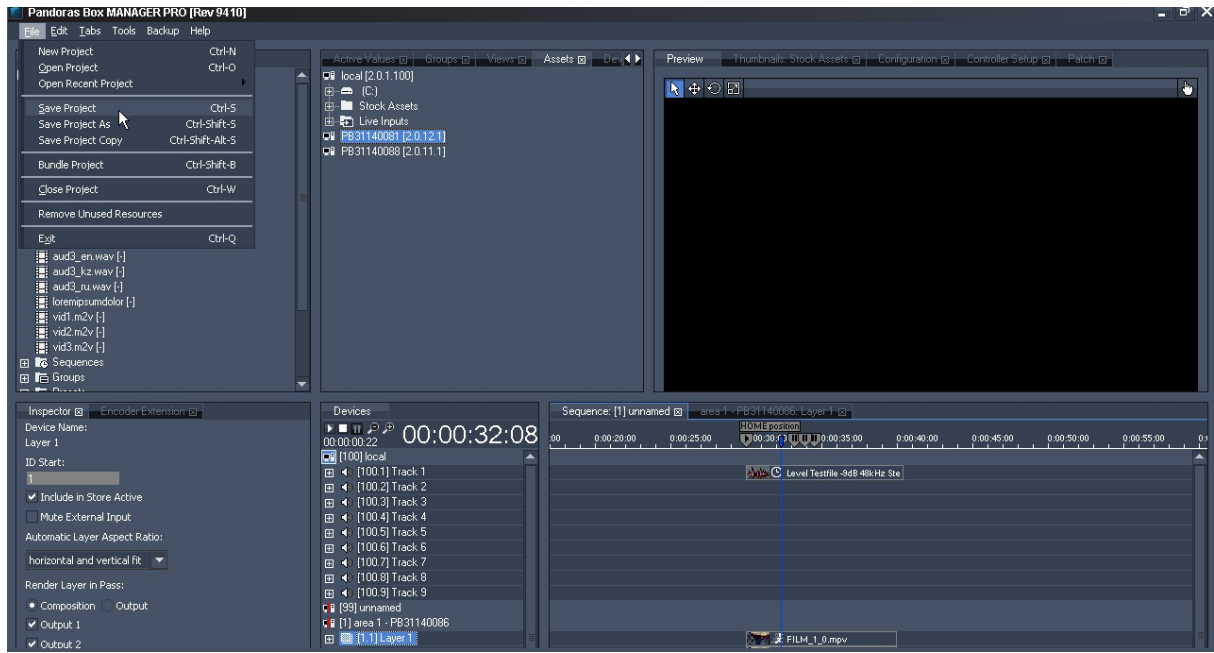

## 5 PANDORAS BOX

The Pandoras Box section is divided into these themes:

[Content](#)<sup>94</sup>  
[User Interface](#)<sup>126</sup>  
[Device Control](#)<sup>296</sup>  
[Input / Output Control](#)<sup>621</sup>  
[Network & Synchronization](#)<sup>646</sup>  
[StreamiX Live Input](#)<sup>650</sup>

### 5.1 CONTENT

All Pandoras Box systems are Windows XP / 2000 based and will allow you to play back multiple audio, video and image formats.

Since real-time rendering requires specific encoding settings, you will find detailed information about the supported file types in the following chapters.

[Display and Content Formats](#)<sup>94</sup>  
[Defining Content Resolution](#)<sup>95</sup>  
[Output Resolution Table](#)<sup>96</sup>  
[Audio Formats](#)<sup>98</sup>  
[Image Formats](#)<sup>98</sup>  
[Image Sequence Formats](#)<sup>99</sup>  
[Video Formats](#)<sup>102</sup>  
[Encoding](#)<sup>103</sup>

#### 5.1.1 DISPLAY & CONTENT FORMATS

Since the invention of film and the area of black & white as well as colour TV, a lot of image formats have been around and are still in use. Three different fields have their specific image formats:

Film	8mm, 16mm, 35mm, IMAX
Television	SD: PAL, PAL+, NTSC HD: 720i/p, 1080i/p
Digital Displays	VGA, SVGA, XGA, SXGA, SXGA+, QXGA, 4k

#### Aspect ratio

All these different image formats have different aspect ratios. The aspect ratio describes the relationship of the image's width and height. A very common aspect ratio used by standard TVs and computer monitors is a 4:3 ratio.

Another - very common - aspect ratio is 1:1,85 which is used for widescreen cinema projection.

In HD digital projection the common aspect ratio is 16:9.

The aspect ratio is a very important figure to consider during content production. Wrong settings lead to distortions in your images, e.g a circle may not look round anymore. In Pandoras Box, you have the following possibilities to influence the aspect ratio of an image:

- [Layer Inspector](#)<sup>208</sup>
- [X and Y scaling](#)<sup>309</sup>
- for more advanced users, the [Camera](#)<sup>589</sup> settings might be of interest.

## Resolution

It is also useful to know the resolution differences between film, television and digital displays. Film is an analog way of recording and projecting images, while TV and digital displays have specific resolutions. When film is transferred to a digital medium, it has to be scanned at a specific resolution; 2K and 4K are common. At this point, it is important to say that the resolutions are superior to High Definition TV.

TV is available through different standards today. The formats PAL and NTSC are called SD: Standard Definition. High Definition is an independent format and is subdivided into progressive scan and interlaced image. Since most digital devices are optimized for progressive scan, this is important for digital projection and digital lighting. High definition is known in two common standards 720i/p (1280x720pixel) and 1080i/p (1920x1080pixel).

In Pandoras Box, the setting "Deinterlacing" can be found in the [content's Inspector tab](#)<sup>[190]</sup>.

Digital displays support multiple resolutions that reach from VGA (640x480pixel) to QXGA (2048x1536pixel).

In the past the most common resolution for digital projectors was XGA (1024x768pixel). Today HD formats are widely used by high profile video projectors on the market.

The next topics give suggestions how to [define your content resolution](#)<sup>[95]</sup>, provide an [output resolution](#)<sup>[96]</sup> table and explain in detail different content formats, such as [audio](#)<sup>[98]</sup>, [single images](#)<sup>[98]</sup>, [image sequences](#)<sup>[99]</sup> and [videos](#)<sup>[102]</sup>.

### 5.1.2 DEFINING CONTENT RESOLUTION

#### Resolution optimization for onscreen design

Depending on the screen design, you may not always need a fullHD resolution for playback. If your setup consists of a large background image with a smaller video insert window, the video resolution of the insert window does not necessarily need to be fullHD resolution. Playing it back with an originally smaller size, will save you performance!

Resizing content to a smaller output resolution may lead to a worse image quality. Therefore it can be more effective if the content has been created for the desired image size.

It is recommended to work with high resolution files if you need the largest flexibility. If the flexibility is not required or if the performance limit is reached, it is better to decide which content must have a smaller resolution.

For a maximum of performance and image quality, the optimum case would be to have all video files in several resolutions. A standard case would be HD, SD and Video-CD format.

#### HD or not HD

Even if your screen has a large dimension, this does not necessarily create the need for a high definition video projection. Creating content in 4k or HD is more expensive than SD and the decision should be taken upon the following considerations. Based on these criteria you should decide, in which resolution your content needs to be created.

How far or close will the audience get to the screen?

Is the nature of the projected image more graphical background animation or real film footage?

What kind of projection medium is used?

What kind of aspect ratio is intended?

What is the native resolution of the projector / display?

The last topic describes the [display and content formats](#)<sup>[94]</sup> in general. The next one provides an [output resolution](#)<sup>[96]</sup> table and explains in detail different content formats, such as [audio](#)<sup>[98]</sup>, [single images](#)<sup>[98]</sup>, [image sequences](#)<sup>[99]</sup> and [videos](#)<sup>[102]</sup>.

---

### 5.1.3 OUTPUT RESOLUTION TABLE

After talking about [display and content formats](#)<sup>[94]</sup> in general and [how to define content resolution](#)<sup>[95]</sup>, this topic shows the standard digital and television resolutions and display sizes.

The next chapters explain in detail different content formats, such as [audio](#)<sup>[98]</sup>, [single images](#)<sup>[98]</sup>, [image sequences](#)<sup>[99]</sup> and [videos](#)<sup>[102]</sup>.



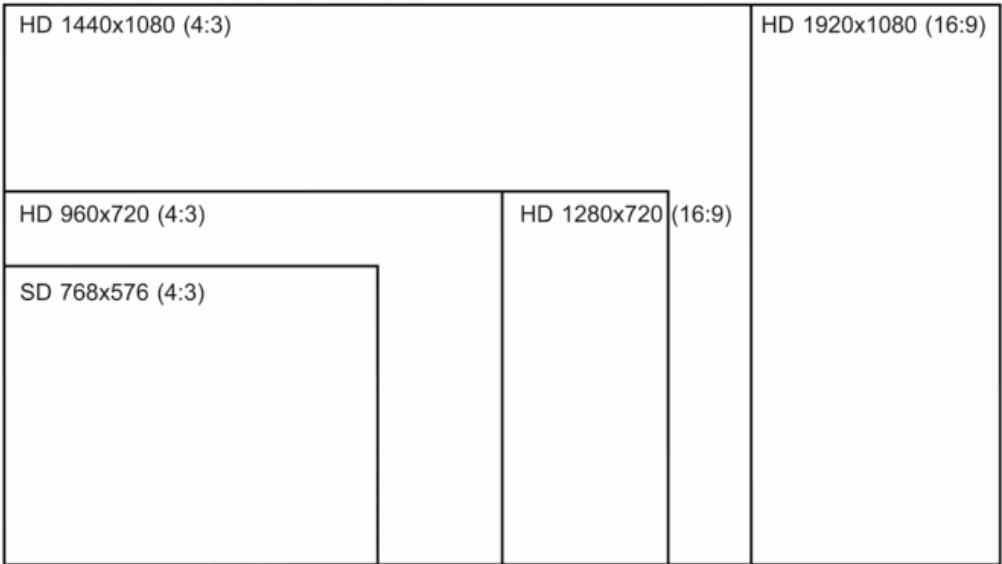
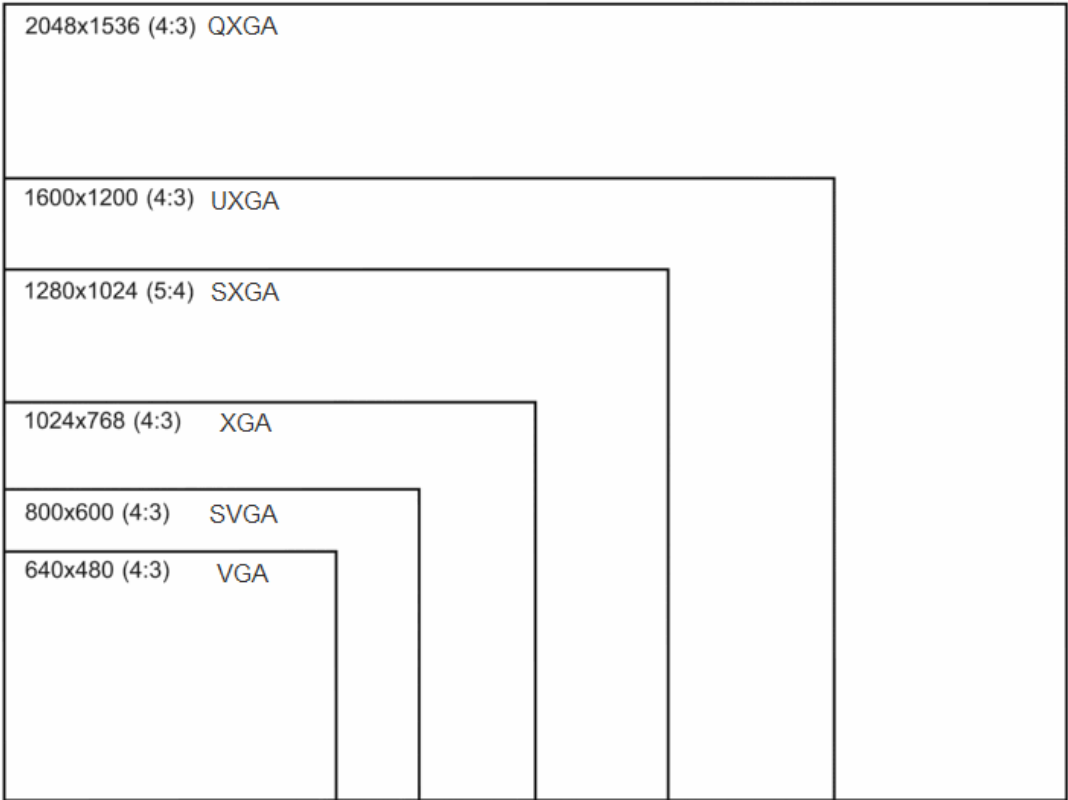

## 5.1.4 AUDIO FORMATS

Audio files may be played back in several different ways within Pandoras Box.

Firstly, you may playback a video file with an embedded audio stream or play an .wav, .mp3 or .mp4 file directly. In order to play .mp4 files please make sure the Quicktime Player is installed on your computer. To convert other audio formats for use in Pandoras Box Servers, you might want to use Adobe Premiere or CleanerXL from Discreet.

Please Note: Please be aware that embedded audio will only synchronize to the local audio clock! It is recommended to separate audio and video files onto individual layers for proper playback.

Secondarily you may play back an audio file using ASIO. The PB Manager, Player and Server software support all common ASIO sound cards and offers audio and video playback synchronization to the audio clock via dedicated Audio Tracks. The number of available tracks differ according to the chosen product. The topic "[Product Overview](#)<sup>[65]</sup>" gives an overview.

The ASIO Tracks will play mono and stereo PCM Wave files (16 or 24 bit) whilst the sample rate depends on the ASIO sound card.

More details regarding the setup and use of ASIO in Pandoras Box can be found in the chapter "[Audio Tracks](#)<sup>[578]</sup>".

Another possibility would be using Sonic Emotion, supporting up to 16 channel audio, please use the Sonic Emotion Hardware Player. For more details please contact [www.sonicemotion.com](http://www.sonicemotion.com).

With the [Sonic Emotion 16CH device](#)<sup>[609]</sup>, mono wave files with 48 kHz 16 bit can be uploaded and synchronized to the Pandoras Box Timeline Playback.

The next topics describe other content formats, such as [single images](#)<sup>[98]</sup>, [image sequences](#)<sup>[99]</sup> and [videos](#)<sup>[102]</sup>.

## 5.1.5 IMAGE FORMATS

Pandoras Box supports the most common file types such as .bmp, .jpg, .tga, .png. Since version 5.5 the dds format is supported too. With version 5.7 we introduced the support of .snp files.

Please make sure, that the images are saved with an RGB(A) color profile as CMYK is not supported.

### Image resolution

There is no resolution limit for the images, but bigger files will be scaled to the maximum texture size of your graphics card. So you don't get any effort using images larger as your texture size!

When using graphic (as well as video) content with more than 2048 x 2048 pixels you might need to alter the texture size in the [Configuration > Render Engine](#)<sup>[153]</sup>. Some FX and features like deinterlacing and FluidFrame need to buffer the media file. The memory space for that purpose is limited to 2k per default. Choosing another texture size will enlarge the buffer for all textures, which increases the used memory space. Thus it will consume plenty of graphic card memory. Please use the option only if needed.

### Image compression, quality and file size

Bitmaps and Targa images provide uncompressed images; this means that there will be no loss of colour depth or resolution. In general uncompressed files have a larger file size than compressed data, thus they are using more memory on the hard drive. Nevertheless, don't be afraid to use them. Pandoras Box converts any image to an uncompressed format anyway to play it back in real-time.

The image format .jpg does an image compression that leads to a lower image quality. The conversion of a .jpg to a .bmp does not enhance its quality, it only maintains the quality. If you save a .jpg as .jpg again, the quality will decrease even more due to the re-compression.

The image format .png does an image compression too, but other than jpg it is a loss-less data compression.

The dds format is a special format. Different to the other mentioned formats, most tools cannot edit or display this format. Photoshop for example offers dedicated plug-ins to support the format. The Image Converter supports the dds format as well, thus it is possible to convert images and provide them for Pandoras Box. You may use them as single images or for image sequences. More information about [image sequences in general](#)<sup>[99]</sup> and the [Image Converter](#)<sup>[838]</sup>...

The dds format claims to perform better than other formats like jpg, png or bmp. In comparison to these formats dds images save performance because it is a texture format that can be interpreted by the graphics card directly. In other words, the CPU and the bus have no load regarding the decompression.

To be accurate, the .snp (snappy) format is actually not an image format itself but a compression library offered from Google. So if you have a .jpg, .png, .bmp or .dds image, snappy compresses the file size but keeps the available quality as it simply reduces the file data. If you work with .snp files, the saving or reading process does not need more time, as the (de-)compression works in highspeed and real-time. In other words, Pandoras Box can decompress snappy image sequences on the fly.

The result is a much smaller file size whereas the size difference depends on redundancy in your visual content, such as alpha channels or same colors in motion graphics. This way you gain a lot more drive space which is especially interesting for SSD systems as their drives normally offer less space.

The tools [Dome Master](#)<sup>[832]</sup>, [Splitter](#)<sup>[848]</sup>, [Image Converter](#)<sup>[838]</sup> and the new [Quicktime Converter](#)<sup>[117]</sup> offer to save images using the snappy format.

## Alpha channel

Alpha is the transparent part of an image where you can always see thru and choose a different background. Pandoras Box will play both alpha file types: Straight Alpha and Premultiplied Alpha.

Each pixel from an image is now saved with its RGBA information: Color and transparency. Not all image format do support this, some are designed to save the RGB color information only. So if you like to create see-through logos or transparent images, use the .tga or png file format, or dds.

The previous topics describe the [display and content formats](#)<sup>[94]</sup> in general, [how to define the content resolution](#)<sup>[95]</sup> and provide an [output resolution table](#)<sup>[96]</sup>. Please click these links, if you are interested in other content formats, such as [audio](#)<sup>[98]</sup>, [image sequences](#)<sup>[99]</sup> and [videos](#)<sup>[102]</sup>.

## 5.1.6 IMAGE SEQUENCE FORMATS

An image sequence is a series of sequential still images that represent frames of an animation. Commonly, the images are saved within one folder and are labeled with an incrementing file name in order to preserve the chronological order. They have the same pixel resolution, size and file format, whereas Pandoras Box supports .bmp, .jpg, .png and the graphics card texture format .dds. With version 5.7 we introduced the support of .snp files.

Please read the previous chapter [Image Formats](#)<sup>[98]</sup> where - among other things - the difference between these formats is explained.

Most high-level programs like Adobe After Effects, Premiere Pro or 3D Studio Max are able to render an image sequence.

### The advantages of working with image sequences

#### + Quality

When rendering an animation as one single video you need to decide which codec should be used. Each codec must decide between high / low file size and low / high image quality. When rendering a png or bmp image sequence, no image information, e.g. color depth or resolution are discarded and thus the

best possible quality is preserved. The downside is the file size.

A good balance is the dds format, even though it compresses the file size the quality does not suffer much. The dds format is a special texture format sent directly to the graphics card without drawing performance from the bus and the processor. This way you may play back much more dds image sequences than with the other image formats. Please refer to the [previous chapter, "Image Formats"](#)<sup>98</sup> for more information.

In addition, always depending on the kind of content, it is possible to achieve better results regarding the quality than the mpeg video format can provide.

#### + Alpha channel

Only few codecs support the alpha (transparency) channel. The recommended codec for Pandoras Box playback - mpeg2 - only supports RGB. Transparent parts must be keyed out, for example with a masking effect and an according mask which can be generated using the [Image Converter](#)<sup>838</sup>. When rendering a png or dds image sequence, you can decide to keep the alpha information.

#### + Safety

When playing back a video you need to have the same codec installed that was used to render the video. When working with special / unusual codecs you have to keep in mind that they need to work platform independently and with good performance. When rendering and playing back an image sequence, no codecs are needed.

#### + Flexibility

Most of the times content production starts before all hardware or technical decisions are made. In case of large scaled high-resolution softedge projections, for example, the total number of projectors might not be known, or the final projector positions are still in question. Cropping images or scaling them down with a batch program is far easier than editing a video. Please see other coolux tools [Dome Master](#)<sup>832</sup>, [Image Converter](#)<sup>838</sup>, and [Splitter](#)<sup>848</sup> that are free of charge. Other image adjustments can be made e.g. with Adobe Photoshop.

Furthermore there might be limitations and misunderstandings regarding the communication between companies that participate in the same project. Sometimes there is no direct contact between the content creator and the operator or other companies within the production chain. In some cases it is a safer or more confident workflow for them to receive an image sequence and either do the final rendering process with one of our above mentioned tools or - since version 5.3 - to playback the image sequence directly in Pandoras Box.

## The disadvantages of working with image sequences

#### - File Size

Bmp image sequences preserve the best image quality possible thus no information is compressed or discarded. That increases the entire system requirements regarding file transfer and memory. The critical question for a smooth playback is definitely the number of pixels per frame and the number of file accesses per second.

#### - Decompression

Png and jpg sequences compress the image's information in order to get a smaller file size. When being played back, the system needs to decompress each single frame. Here not only the number of file accesses per second is critical, but also the processor's performance consumption due to decompression. For that reason we recommend to use bmp sequences. If you like to playback png or jpg sequences you might want to alter the number of threads used, this is described below.

**It is recommended to use image sequences in Pandoras Box with SSD drives** as normal hard drives are slower regarding the number of file accesses per second. If you do not necessarily need to change individual frames during playback it is a very good and recommended workflow to render an uncompressed avi at the very end of the content production; you may use the [Image Converter](#)<sup>838</sup> for example. The avi format combines all advantages but as it is only one file, the system will be able to load it faster and the playback requires less performance.

## How to use an image sequence in Pandoras Box

Just like any other file an image sequence must be first added from the Asset tab into the Project tab. It is recommended to save all images belonging to one sequence within one folder as well as to remove all other images (and other files, e.g. .dsstore, indexing files added automatically from MAC operating systems) not belonging to the sequence from this folder! In order to add the image sequence you cannot simply drag the folder, as this would generate a folder with multiple files. Right-click on the folder within the Assets tab and choose "Import As Image Sequence". A dialog opens and asks for the frame rate; depending on how the content was created enter for example 25fps or 30fps. As seen below, at this time a new resource with the sequence icon was added to the Project tab.

A second way to add a sequence to the project would be to right-click in your Project tab, choose "Add Image Sequence" and attach a sequence using the Inspector.

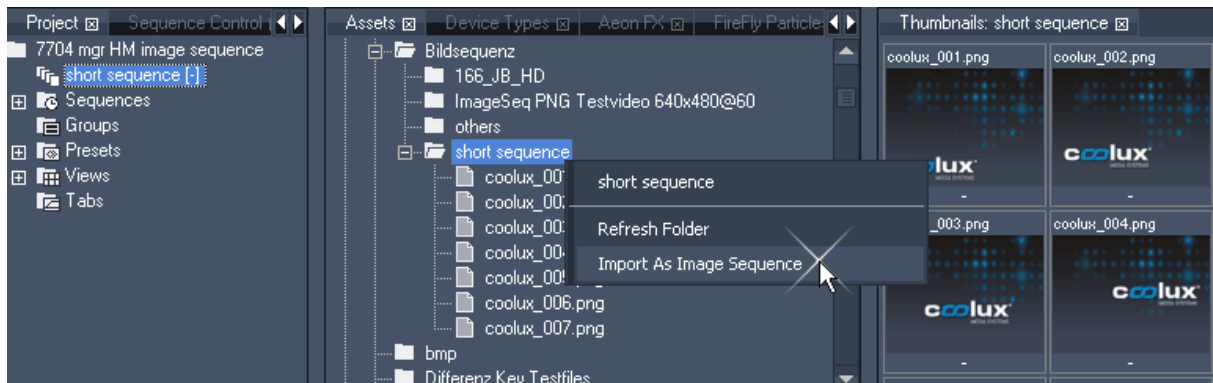

Now you can start programming with the image sequence by dragging the sequence from the Project tab into the timeline or by assigning it to a layer via double-click after selecting one in the Device Tree tab. If the sequence does not play back fluently, you can activate "Fluid Frame" in the Inspector (select the sequence in the Project tab to see its information in the Inspector). As well you can choose another setting in the text field "Number of Threads". The other options are explained in the topic "Image Sequence Inspector".

The number of threads influence how many threads are called by the Pandoras Box application from the operating system in order to run the sequence. There is no rule of thumb how many threads are the best. A higher number of threads can make the sequence run more smoothly and at the same time a too large number can make the playback more stuttery. There is no definite minimum or maximum. It depends on your hardware, e.g. the processor and type of hard drives. Regarding bmp sequences the default setting of 5 will give you good results. As png and jpg sequences require more processor performance, another thread number can give you better results. The optimal number depends on their compression rate. Please make sure that the thread number is smaller than the total number of images in the sequence.

### Tips for the workflow for image sequences

Before using image sequences in Pandoras Box...:

- Check the file names:

best is to name all files with the same number of characters, in other words, if you have 100 files, the first one should be named image001 instead of "image"

- Delete additional files from the folder:

best is to have a folder including the same number of files as images (there should be no thumbs file, notes or administration data)

- Name the folder with the frame rate:

best is to have a folder including the frame rate the image sequence was rendered out for, e.g. "Stars\_25fps"; ask the content creator to do that for you; this way you will later on, know for sure with which frame rate the image sequence should be imported

The previous topics describe the [display and content formats](#)<sup>94</sup> in general, [how to define the content resolution](#)<sup>95</sup> and provide an [output resolution table](#)<sup>96</sup>. Please click these links, if you are interested in other content formats, such as [audio](#)<sup>98</sup>, [single images](#)<sup>98</sup> and [videos](#)<sup>102</sup>.

## 5.1.7 VIDEO FORMATS

There are several video formats on the market. Pandoras Box Server aims to support most of them.

PB supports the following video file types:

.avi, .wmv, .mpg1, .mpg2, mpg4, .mov.

Also supported video file types:

.mxf (e.g. used by Avid and Sony XDCam). A dedicated decoder is required.

.mxi (proprietary coolux file type, basically it is a mpg2 format). The implemented [Encoder Extension](#)<sup>104</sup> enables you to encode and decode 4k resolution files in this format (depends on available graphic card RAM).

Please note:

PB Player versions are limited regarding the play back of large videos, currently the limit is 4k for the maximum file resolution.

On PB Servers, when using video content with more than 2048 x 2048 pixels you might need to alter the texture size in the [Configuration > Render Engine](#)<sup>153</sup>. Some FX and features like deinterlacing and FluidFrame need to buffer the media file. The memory space for that purpose is limited to 2k per default. Choosing another texture size will enlarge the buffer for all textures, which increases the used memory space. Thus it will consume plenty of graphic card memory. Please use the option only if needed.

For more information about differences in Players and Servers, please read the [Product Overview](#)<sup>65</sup>

### Codecs

A video codec is a compression / decompression method based on a specific algorithm, optimized for different uses, e.g. for web, CD or DVD use. Not all codecs are optimized for synchronized playback. An important thing about the AVI, Quicktime and .mxf file format is its kind of container format. This format may contain different video codecs, it is not clearly determined by its file extension.

Pandoras Box uses all available codecs that are currently installed on your Windows system.

If a video file may not play in Pandoras Box, please check if the codec is installed. For Windows XP systems you may try to playback the file in Windows Mediaplayer. Windows Mediaplayer is able to display the properties and codecs of the loaded files.

Other media players are not recommended as they might use their own codecs which are installed on the system and cannot be used by other applications.

You might need to re-encode the file in a codec that is supported by Pandoras Box. For re-encoding we recommend to use the [Encoder Extension](#)<sup>104</sup>.

### Optimum video playback and bit rates for encoding

For a proper video playback with synchronization we recommend video files to be encoded to Mpeg2 (.mpg), respectively to .mxi. Other codecs might be used, but it is recommended to test new codecs before using them on a show.

Each codec must meet the two demands to encode a file with low file size but high image quality. The mpeg codec strikes a good balance between the two demands. At the same time it supports the possibility to playback the file with frame accuracy and synchronization.

In general it does not support to have an alpha channel included (transparent information). However,

coolux developed a feature in the external tool Image Converter that allows to use [mpeg with alpha channel](#)<sup>[838]</sup>.

To provide a synchronized playback it is mandatory to encode the Mpg2 files with a constant bit rate (CBR) and as elementary video only! That means that the audio information needs to be splitted or discarded. Even if the audio level is at 0db, it is still included in the file and will destroy the possibility to play it back synchronized.

The bit rate itself depends on the content. The more pixels each frames has, the higher the bit rate needs to be. The more different color information the frame has, the higher the bit rate should be to preserve quality. The statement that coolux gives, e.g that a Server may play back 4 HD files smoothly refers to the recommended bit rates seen below. If you encode HD files with a higher bit rate you will not be able to play back four files at the same time!

Recommended bit rates:

PAL or NTSC resolution: up to 8.000 kbit/s with a progressive scan

HD resolution: up to 20-25.000 kbit/s

4k resolution: up to 80-120.000 kbit

### Playback with uncompressed formats

If you are interested in playing in uncompressed formats please keep in mind that those codecs preserve the best possible image quality but also lead to very large files. They draw plenty of performance during playback. We recommend to use uncompressed formats with SSD drives. You might also be interested in [image sequences](#)<sup>[99]</sup>.

The previous topics describe the [display and content formats](#)<sup>[94]</sup> in general, [how to define the content resolution](#)<sup>[95]</sup> and provide an [output resolution table](#)<sup>[96]</sup>. Please click these links, if you are interested in other content formats, such as [audio](#)<sup>[98]</sup>, [single images](#)<sup>[98]</sup> and [image sequences](#)<sup>[99]</sup>.

## 5.1.8 ENCODING

To transcode most AVI-and Quicktime as well as WMV files to Mpeg1 or 2 in SD, HD or custom resolution, please use one of the following tools:

- [Pandoras Box Encoder Extension](#)<sup>[104]</sup>

This Encoder is implemented in every Pandoras Box Software (up from Vers. 4.5). It allows Auto-Encoding when adding files into the project.

Please note that the Encoder Extension needs to be activated on your dongle, depending on your license this will be fee required.

- [Mainconcept MPEG Encoder](#)<sup>[109]</sup>

This Encoder is installed on older Pandoras Box Servers. This chapter is only interesting for users who have no access to the Pandoras Box Encoder Extension.

To transcode any Quicktime codec to a .dds, .png and .bmp image sequence (a folder containing sequential images), or .mov files (containing sequential frames) please use the Quicktime Converter:

- [Quicktime Converter](#)<sup>[117]</sup>

This tool comes with every Pandoras Box installation and can be found in the "Tools" menu of the PB Master.

To encode your content to a .dds, .png and .bmp image sequence (a folder containing sequential images), or .mov files (containing sequential frames) please use the coolux codec:

- [coolux codec / Quicktime component](#)<sup>[115]</sup>

The codec can be used for content creation. Load the codec into third-party rendering software solutions like AfterFX; or third-party content converters like the Quicktime Player.

### 5.1.8.1 ENCODER EXTENSION

The built-in Pandoras Box Encoder Extension allows to transcode most AVI -and Quicktime- as well as WMV files to Mpeg1 or 2 up to a 4k resolution. The files will be encoded to MPEG Elementary Video Streams. If the original file contains audio, a separate wav-file will be created

The resolution can be set to SD, HD or a custom one. The Encoder Extension allows you to transcode files larger than 1080p to our proprietary .mxl format. The maximum resolution is 4080x2800 px and the encoding process depends on available graphic card RAM.

Please read the topic "[Video Formats](#)<sup>102</sup>" if you are interested in knowing more about video formats and codecs that are supported by Pandoras Box and about optimum video playback.

To open the Encoder Extension Tab, please click on the Tabs Menu and choose Extensions - Encoder Extension. The Encoder Extension tab will appear next to the Inspector tab.

Please note that the Encoder Extension needs to be activated on your dongle, depending on your license this will be fee required.

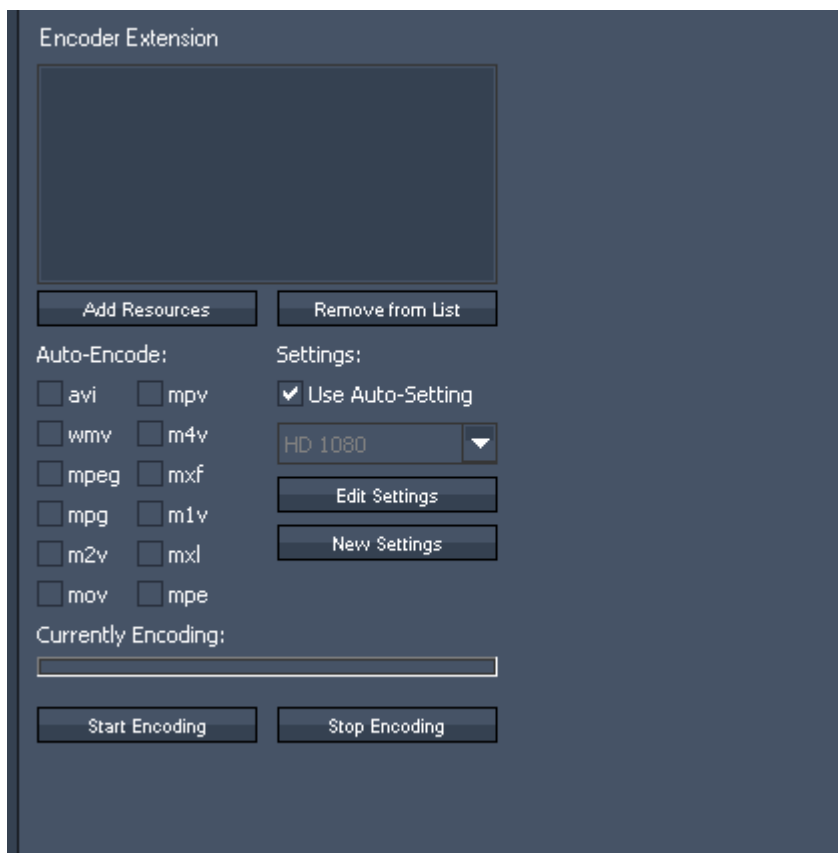

#### Auto-Encode

To use the Auto-Encode function please set a check in front of all file formats that should be automatically encoded when added into your project.

The Encoder Extension supports the following file formats:

- avi
- wmv (Windows Media Video)
- mpeg (Mpeg)
- mpg (Mpeg)
- m2v (Mpeg 2 Video only)
- mov (Quicktime Video)
- mpv (Mpeg)
- m4v (Mpeg 4 Video)



mxf (File Exchange Format e.g. used by Avid and Sony XDCam)  
 m1v (Mpeg 1 Video only)  
 mxl (proprietary coolux file type)  
 mpe (Mpeg)

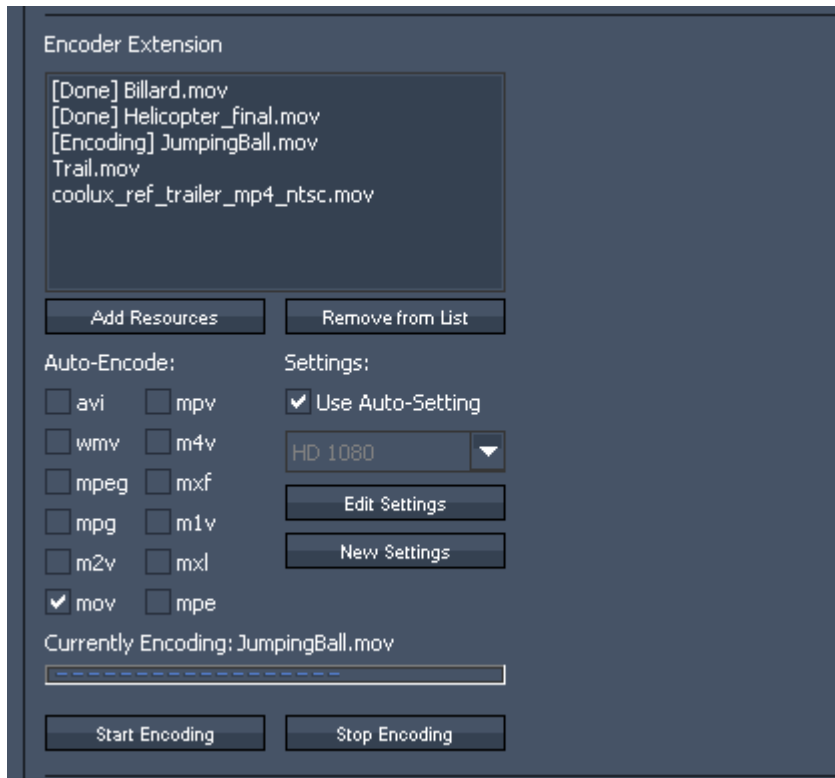

The added files will appear in the Encoder Extension Window, the encoding starts automatically. The status bar shows the progress of the currently encoded file. Once a file is completely encoded, the file extension in the project tab changes to .mpv. The original file is discarded from the project but kept in the windows folder from where you added the file into the project.

To stop encoding, please press "Stop Encoding". Pressing "Start Encoding" will continue the encoding process.

### Manual encoding

To encode files manually please select the files in the project tab.

In the Encoder Extension press "Add Resources", the selected files will be added into the Encoder Extension window. The drag and drop function does not work here. To start the encoding process press "Start Encoding".

Now everything behaves as described for the Auto-Encoding.

#### REMOVE FROM LIST:

To clear files from the encoder extension window - no matter if new encoded or not, select the files and press "Remove from List".

### Settings

#### Auto-Settings

Using Auto-Settings will encode all your files to MPEG2 Elementary Video Stream.

The bit rate will be set to a constant bitrate: CBR 8.000 kbit/s (SD) or CBR 20.000 kbit/s (HD).

The field encoding will be set to "Progressive Frame".

All other parameters like video mode (PAL or NTSC), resolution and frame rate will be adopted from the original file and are not affected through encoding.

### Choose Profiles manually

By unchecking "Auto-Settings" you will be able to choose one of the default profiles manually.

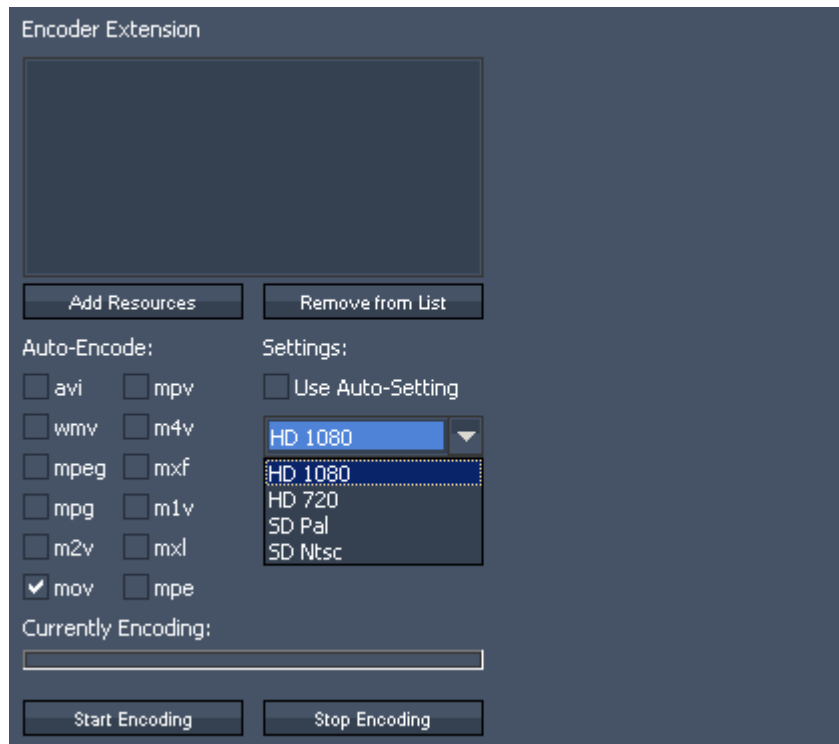

Using one of the default profiles will not only affect the bitrate and field encoding but might change the files resolution: e.g. encoding an HD-file (resolution 1920x1080 px) using the SD PAL Profile will resize the video to 720x576 px.

Please note: the default profiles can not be edited.

### Creating new profiles

Please uncheck "Auto-Settings" and press "New Settings" to create a new encoding profile.



The new dialog allows you to:

**[Name]**  
Name the profile

**[MPEG Type]**  
Choose the MPEG Type (MPEG-1 or MPEG-2)

**[MPEG Profile / Level]**  
Set MPEG Profile and Level. Please note that you will need High Profile (Profile 4:2:2) and High Level for HD 1920x1080 px resolution. The Level automatically changes to MXL if you encode files to a format bigger than 1920 x 1080 px.

**[Resize Video]**  
To resize your video, check the box and insert the resolution your video file should be resized to. Note that the "MPEG Type" and "Level" influence the maximum allowed resolution. In general, the highest resolution is 4080x2800 px for the mpeg2 format and MXL level.

**[Bitrate]**

Choose an amount of kbit/s (recommended are about 8.000 kbit/s for SD, 20-25.000 for HD and 80-120000 kbit/s for 4k)

**[GOP-Length]**

The length of the Group of Pictures is editable from 1 to 100. The higher the GOP-Length the better the compression rate gets at the expense of quality.

**[Number of B-Frames]**

Choose a value between 0 and 7.

**[Deinterlacing]**

To enable Deinterlacing, please check the box and also choose a Field Order.

**[Motion Estimation Level]**

Set a value between 0 (no motion search) and 15 (high quality). The higher the value, the better the quality, the longer the encoding process.

**[Motion Estimation Range]**

Set a value between 0 (no motion search) and 15 (high quality).

**[Scene Change Detection]**

Choose between None, Fast and Refined.

**[Audio Processing]**

- Discard: discards the Audio Part, the video file extension
- Split to separate wav. splits the Audio part to a separate wav-File. This file will be added into the project. automatically. On the hard-drive it will be created in the same folder where the related video source is located.
- Include: includes the Audio Part into the encoded video (the video file extension will be "mpeg").

The Audio Part is discarded by default.

If there is no Audio Part included in the encoded video file, the file extension will be \*.mpv (Video Elementary Only). Including an Audio Part, the video file gets the extension \*.mpg

Click OK when the new setting is finished. The created profile will appear in the drop down menu.

**EDIT SETTINGS:**

Select your profile from the drop-down list and click "Edit Settings". All settings are described above in "Create New Settings".

Please note that the default profiles are not editable!

### 5.1.8.2 ENCODING (up to Version 4.5)

Pandoras Box Servers up to Version 4.5 ship with the Mainconcept MPEG Encoder that allows to transcode most AVI and Quicktime as well as WMV files to Mpeg1 or 2 in both SD, HD or custom resolution.

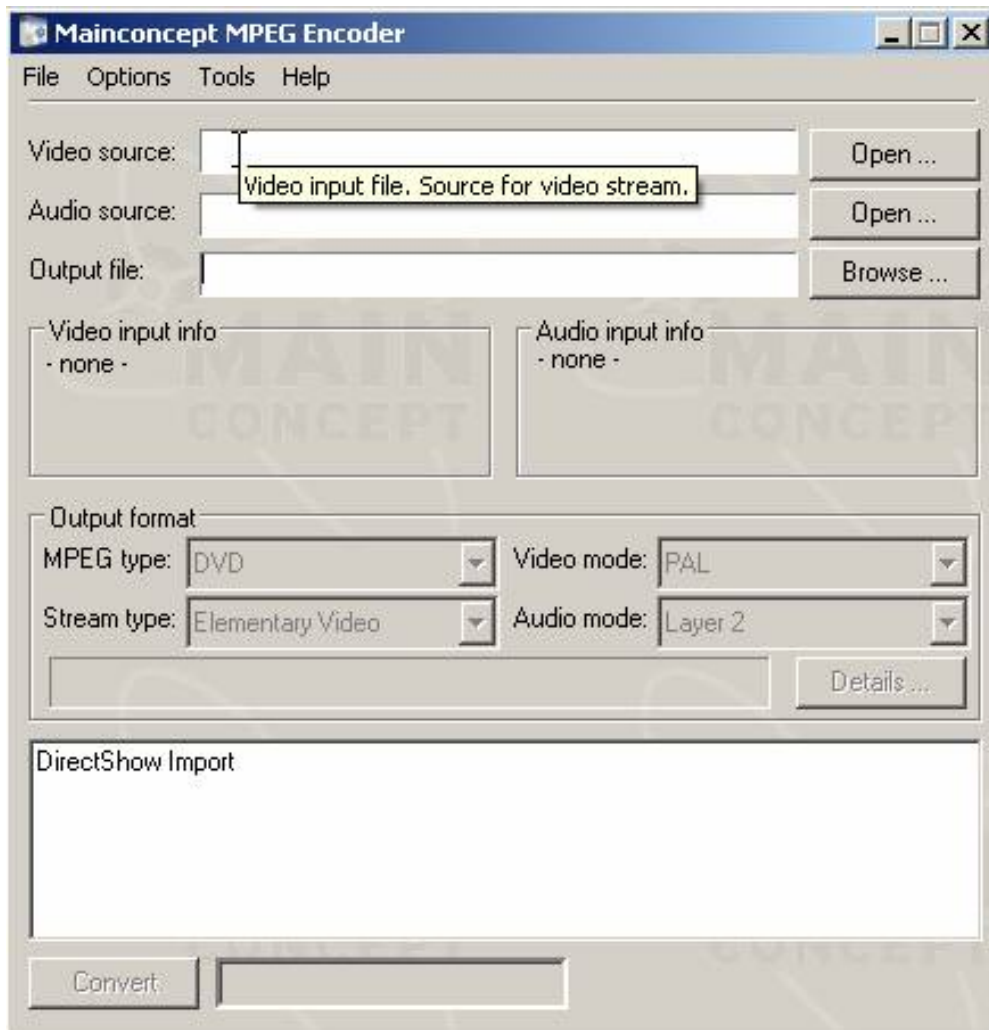

An extensive help file is provided with the encoder. The easy steps to encode SD or HD files are explained below.

#### SD - PAL/NTSC Encoding

To start encoding, please open the Mainconcept Encoder from the Start menu.

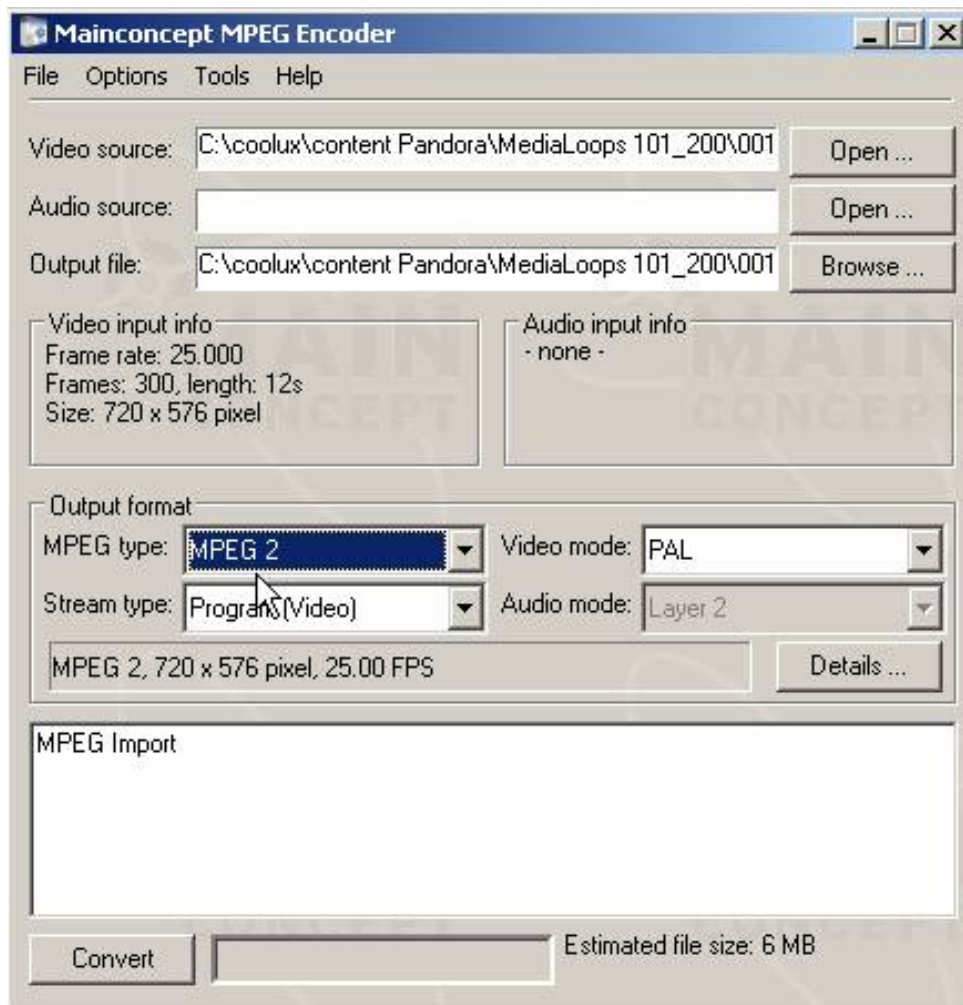

Click on the “Open...” button in the video source section to load your source file that you want to encode. You may also drag and drop a file from a directory directly into this section.

Choose “MPEG2” as MPEG type and - depending on the format - choose NTSC or PAL. If your source file contains any audio that should be encoded, use Program (Audio and Video) or Elementary Video to encode Video only.

Then click on details to set up the advanced features of the encoder.

PLEASE NOTE:

FOR SYNCHRONIZED NETWORK PLAYBACK, ALL FILES MUST BE ENCODED AS ELEMENTARY VIDEO ONLY!

Then click on details to set up the advanced features of the encoder.

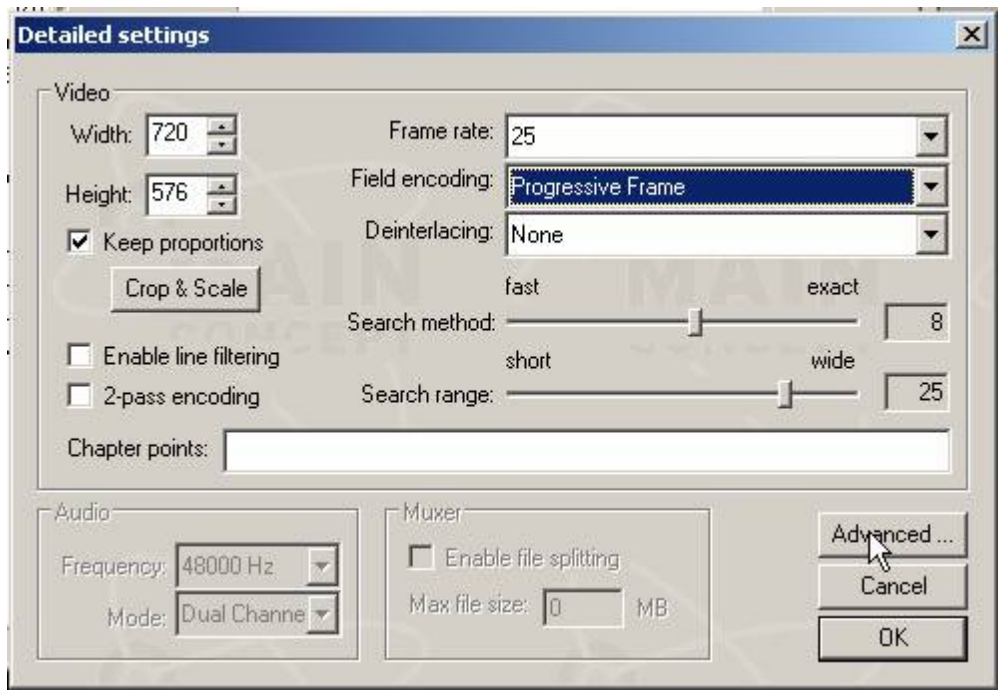

In the detailed settings you will need to set the field encoding to “Progressive Frame”.  
 The video resolution can be set in width and height.

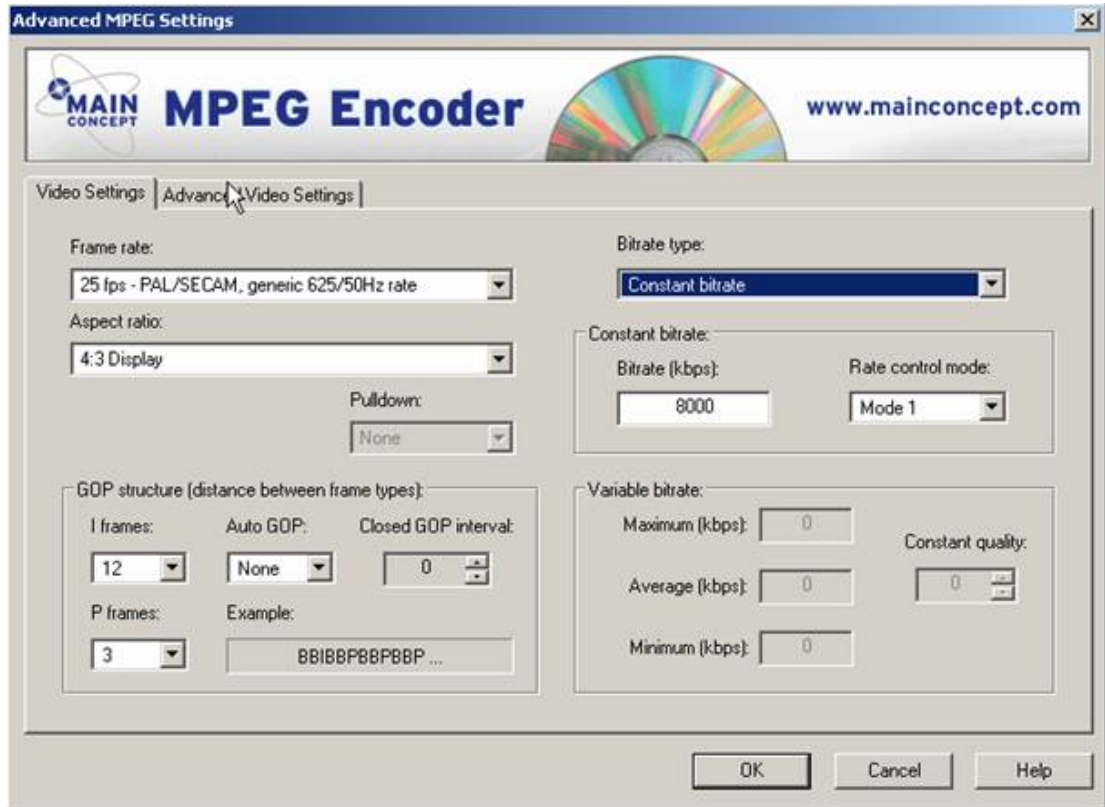

In the Video Settings tab of the advanced menu make sure to set the frame rate aspect-ratio according to the source file.  
 It is important to set the bit rate type to constant bit rate and choose a bit rate between 6000-8000 kbp/s.

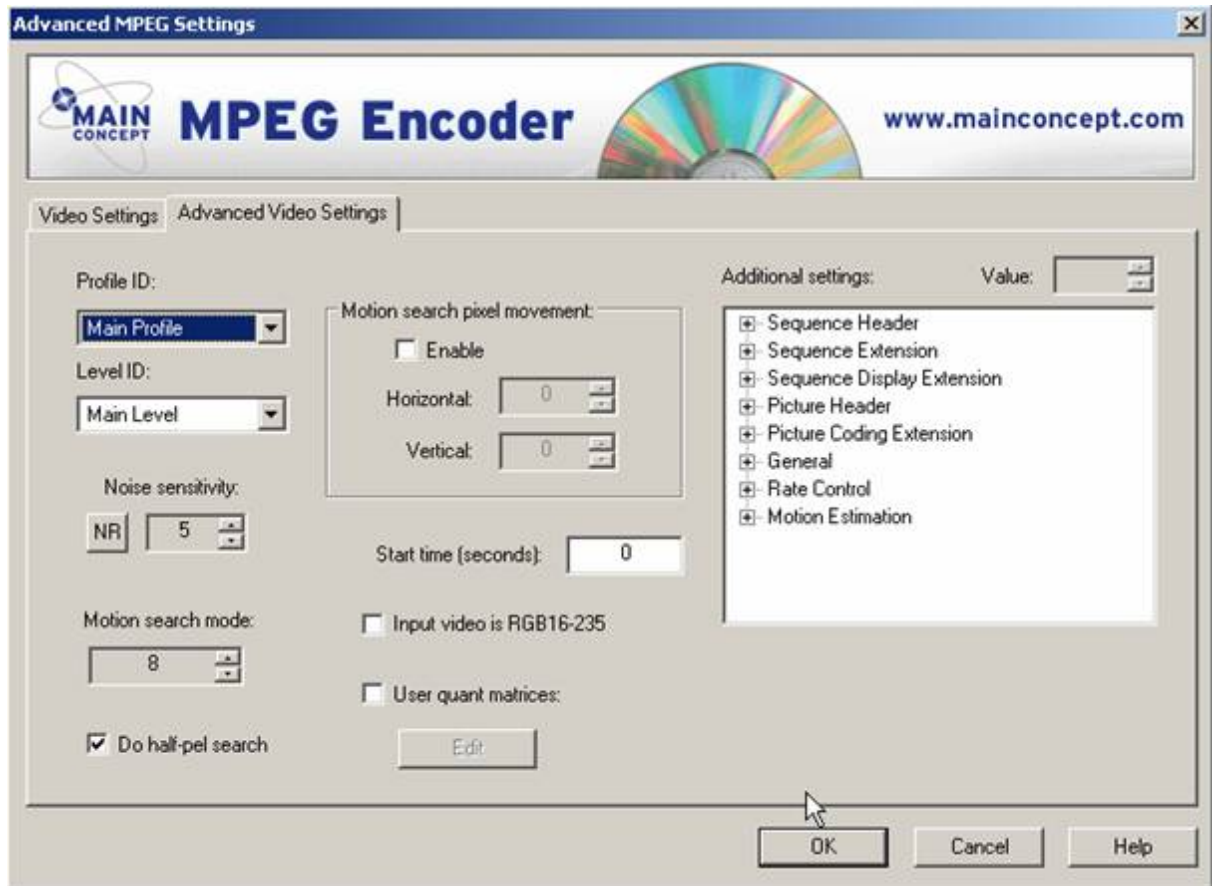

Click on the “Advanced Video Settings” tab and make sure that both profile and level ID are set to main, all other parameters should be set to default.

Now return to the main menu by clicking “OK”.

To launch the encoder, click in the main user interface on “Convert”



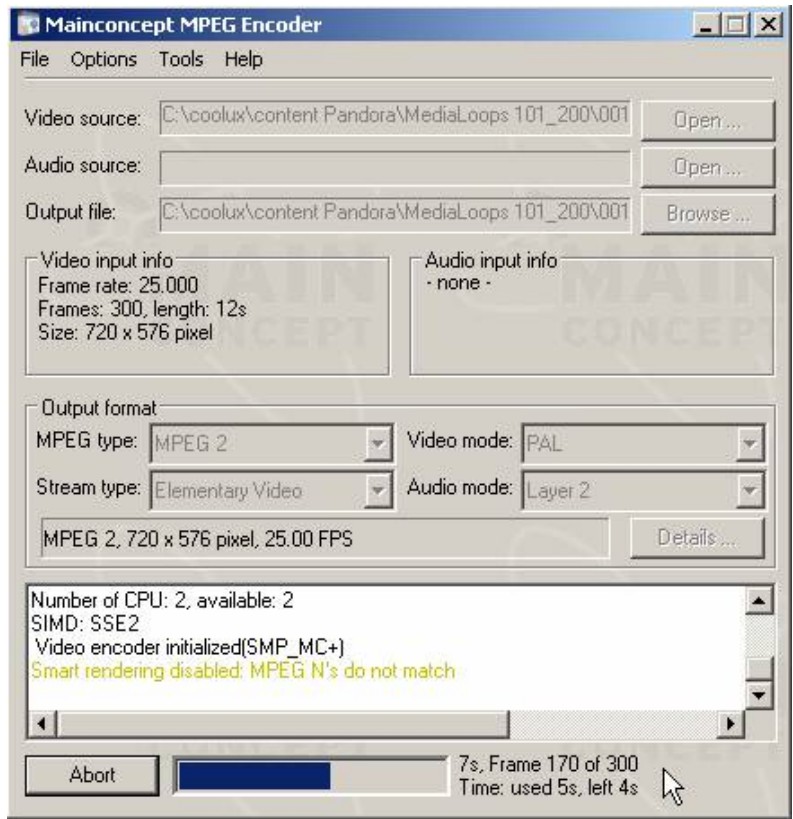

HD - PAL/NTSC Encoding

Compared to SD, the HD encoding requires both the profile and level ID to be set to high.

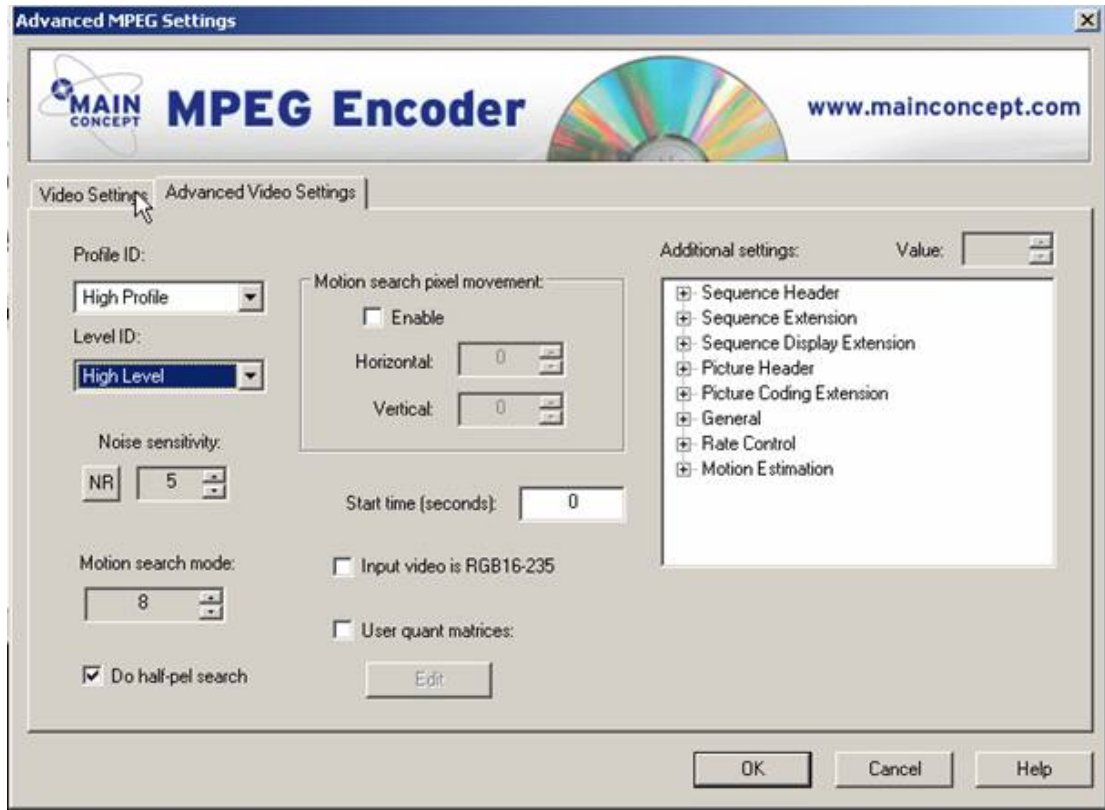

With these settings, resolutions above 768x576 can be accessed and configured.

It is recommended to start further reading in the Mainconcept Encoder manual for more in-depth details.

PLEASE NOTE:

FOR SYNCHRONIZED NETWORK PLAYBACK, ALL FILES MUST BE ENCODED AS ELEMENTARY VIDEO ONLY!

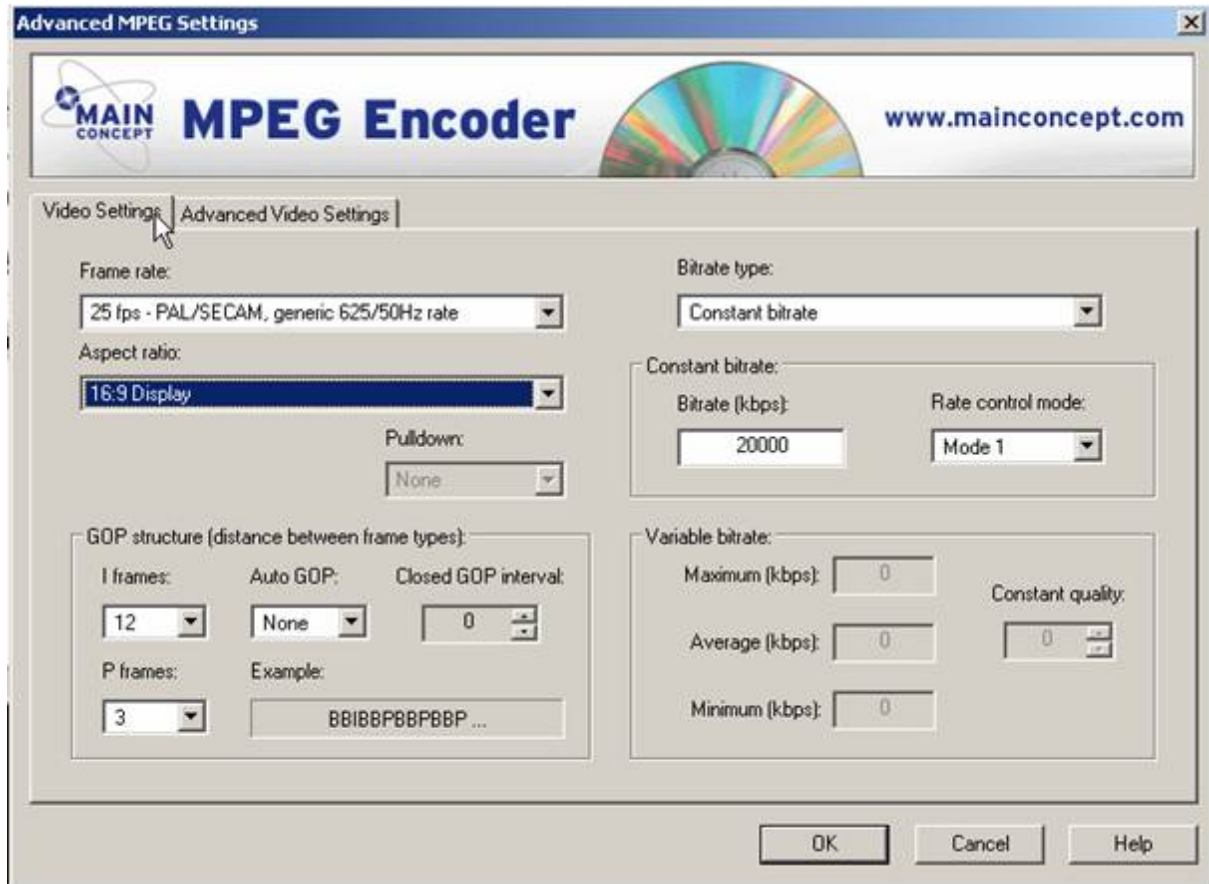

For HD playback, you may choose a constant bit rate of 10000-20000 kbp/s.

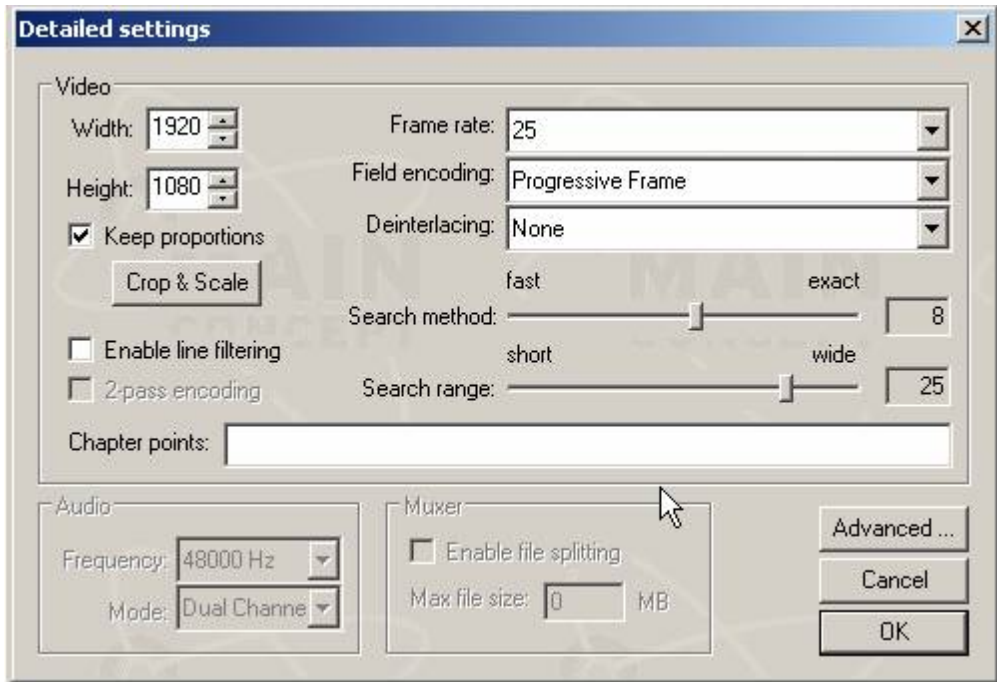

Before you leave the advanced mode, check the target resolution as well as field encoding and frame rate.

**5.1.8.3 COOLUX CODEC**

coolux has developed a codec for use on PC and Mac. With this codec, content artists can directly produce .mov files or image sequences for Pandoras Box without any further transcoding step. Keep in mind that image sequence playback is mainly aimed for SSD based systems. Pandoras Box is able to playback uncompressed image sequences. So if the sequence was rendered in an according lossless file format, you can play it back without any quality loss as Pandoras Box never compresses files internally!

**In what programs can the codec be used?**

Obviously, Pandoras Box software itself can play back videos rendered with the coolux codec. No further steps are necessary, simply install Pandoras Box (Rev 10386 or newer) and the latest Quicktime Player.

The codec can be used for content creation, especially when there must not happen quality reducing and time consuming format conversion. Load the codec into third-party rendering software solutions like AfterFX

It can be also used in (third-party) content converters like the Quicktime Player or the Quicktime Converter from coolux.

In both workflows, the codec renders content by using the Quicktime API. This is, why the codec is also called the "Pandoras Box Quicktime Component".

As soon as you have installed the coolux codec you can access it. Simply start or execute the according encoding / transcoding command which then offers a drop-down list to choose a custom format. The coolux codec is listed as "coolux".

**Where can the codec be downloaded?**

If you have installed the latest Pandoras Box version, the codec is already available on your system.

If you like to use the component without PB, download it from our web site's "[Download Center](#)" and install it on your PC or Mac system. Note that Mac OS 10.7 or newer is the minimum required version for the coolux QT components to work, older OS version will not be supported. On Mac and Windows PC systems, the codec requires the latest [Quicktime Player](#) for rendering as well as playback.

### In what formats does the codec render?

First of all, the component allows to create .dds, .png and .bmp [image sequences](#)<sup>[99]</sup> (RGB or RGBA, i.e. with transparency). To save disk space you can choose to directly compress the image files using the .snp format. No matter what format you chose, the result from the rendering process is a folder with separate single (image) files. The folder can be played back from Pandoras Box by choosing "Import as Image Sequence" in the [PB Assets tab](#)<sup>[137]</sup>. Snappy image sequences are decompressed on the fly. To play the image sequence on another system than Pandoras Box, you need to choose a media player that supports image sequences.

Secondly, the component allows to render a .mov file. By using our codec in the mov container, you have the advantage of the same quality as an image sequence offers. That is because the container simply contains the single (image / frames) files, there is no additional intra-frame compression. On the other hand, you gain the advantage of a single file, that is a more convenient file handling and management. The advantage of using a .mov file is, that everybody can play the content with a Quicktime Player. To play the .mov file in Pandoras Box, simply drag it into your [Project tab](#)<sup>[248]</sup>. Please keep in mind that eventhough PB can playback these .mov files, .mov files containing other codecs are not recommended playback formats! All .movs require an installed Quicktime Player during playback.

## How to convert other .mov files? What is the coolux Converter?

As mentioned above, .mov files containing other codecs are not recommended playback formats for Pandoras Box.

However, you can convert other .mov files using either a Quicktime PRO Player or the new coolux tool called the Quicktime Converter.

The Quicktime PRO Player allows to access the coolux codec as soon as it is installed on the system.

The Converter allows to read, i.e. decode any .mov file as long as the codec used in its container is installed on the system. Again, the latest Quicktime Player needs to be installed. Afterwards it renders i.e. encode the file into an image sequence or single .mov using the new coolux codec instead. You may find the Converter along with all other coolux tools (Warper; Matrix Patcher,...) in the "Tools" menu in Pandoras Box.

The next chapter covers the use of the [Quicktime Converter and the codec settings](#)<sup>117</sup>.

### 5.1.8.4 QUICKTIME CONVERTER

This topic explains how to use the coolux Quicktime Converter using the coolux codec, and the codec settings itself. Please refer to the previous chapter for [general information about the coolux codec](#)<sup>115</sup> also called the coolux Quicktime Component.

If you use the coolux codec in third-party software like AfterFX and the Quicktime Player PRO, please refer to their documentation to learn how to start the encoding process itself. There should be somewhere a choice what format you like to render in. The coolux codec is listed as "coolux". The first of the below steps do not apply to you, the others do eventhough the dialogs probably look different.

As mentioned in the last topic, the Quicktime Converter allows to transcode other .mov files into a format that is recommended for Pandoras Box. The coolux codec renders i.e. encodes image sequences (a folder containing sequential images), or .mov files (containing sequential frames).

Keep in mind that image sequence playback is mainly aimed for SSD based systems.

To convert other .mov files, install the latest Quicktime Player and start the coolux Quicktime Converter.

### How to start the coolux Quicktime Converter?

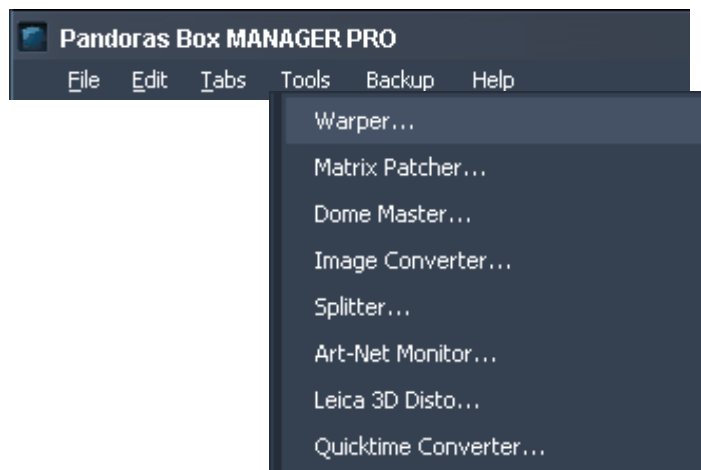

You may find the QuicktimeConverter along with all other coolux tools (Warper; Matrix Patcher,...) in the "Tools" menu in Pandoras Box. Alternatively, you can open the Windows Start Menu or File Browser and go to Programs > coolux > Pandoras Box Rev ... (> data) > Tools > Quicktime Converter

## How to choose a source file?

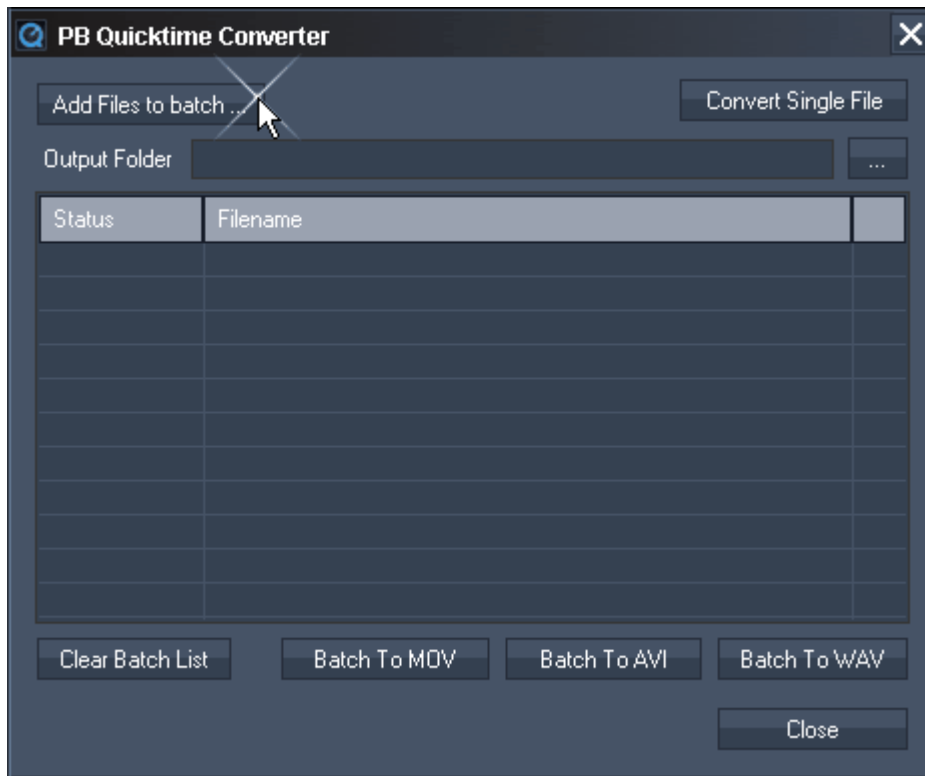

### Single File:

The "Convert Single File" button opens a dialog where you can choose a .mov file as a source. As soon as you have picked one, the "Export As" dialog opens automatically.

### Batching:

With the button "Add Files to batch" you may choose several source files that will be added to the batch list. Click the button again to (multi-)select additional files. Enter a output folder yourself or click the [...] button. In this folder all new files will be exported with the same name as the source files. Click one of the "Batch To..." buttons to convert all files.

Please note that a .mov file is a so called container format, which means that it can contain other codecs. If the coolux Converter fails to read your source file(s), make sure that the source codec is installed on your system.

## How to choose the export format?

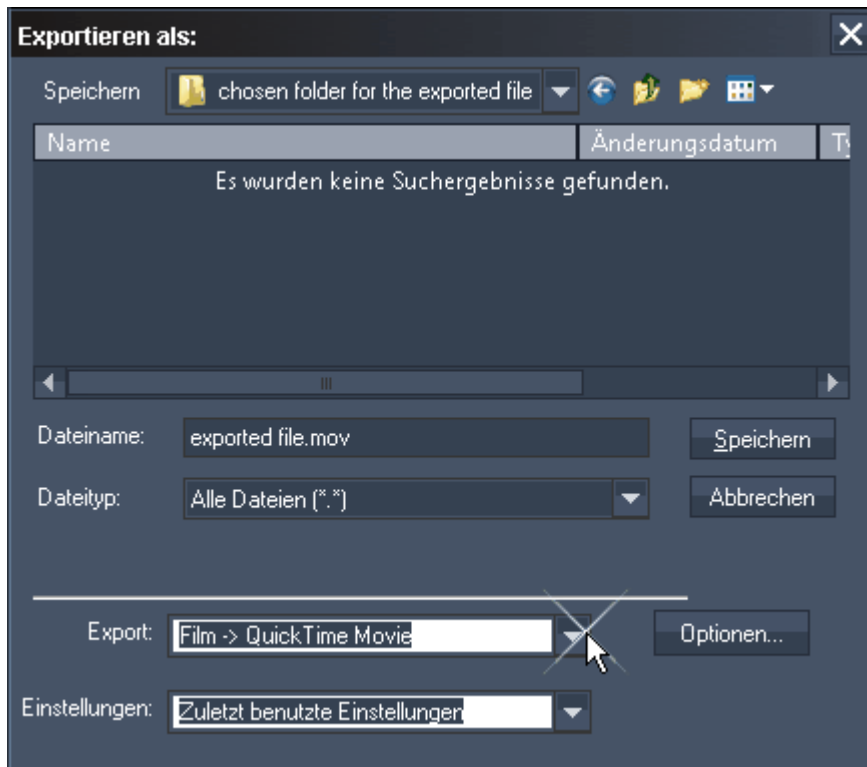

### Single File:

The "Export As" dialog opens automatically. Enter a name and choose the entry "Film -> QuickTime Movie" in the "Export" drop-down list.

Click the "Options" button to the right, to set up the output format in more detail. If you use the Converter for the first time, it's strongly recommended to set up the format according to your needs. Every following rendering will call the settings previously chosen as a new default.

### Batching:

This dialog is skipped when you clicked a "Batch To..." button.

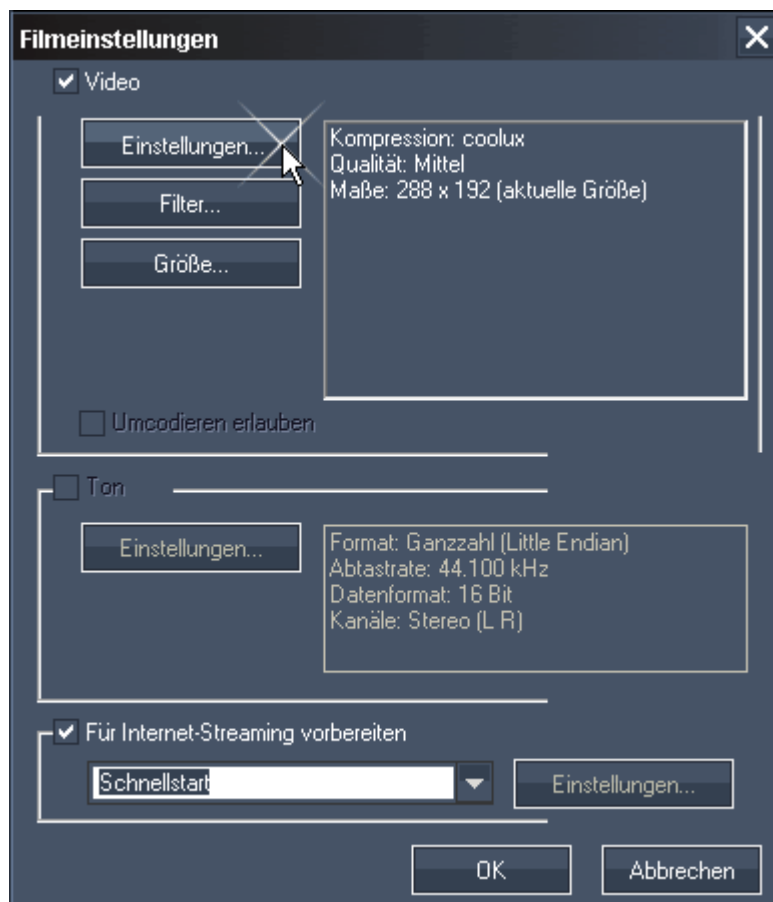

In the "Movie Settings" dialog, click "Settings".

Click "Filter" only if you like to add or adjust additional video filters. If you wish to resize your movie, click "Size".

If your original .mov file contains audio information, you can choose to export a separate wave file. Click "Settings" if you like to change the default settings regarding sample rate etc. For ASIO playback please ensure that "PCM" is chosen.

Internet-Streaming is not needed.



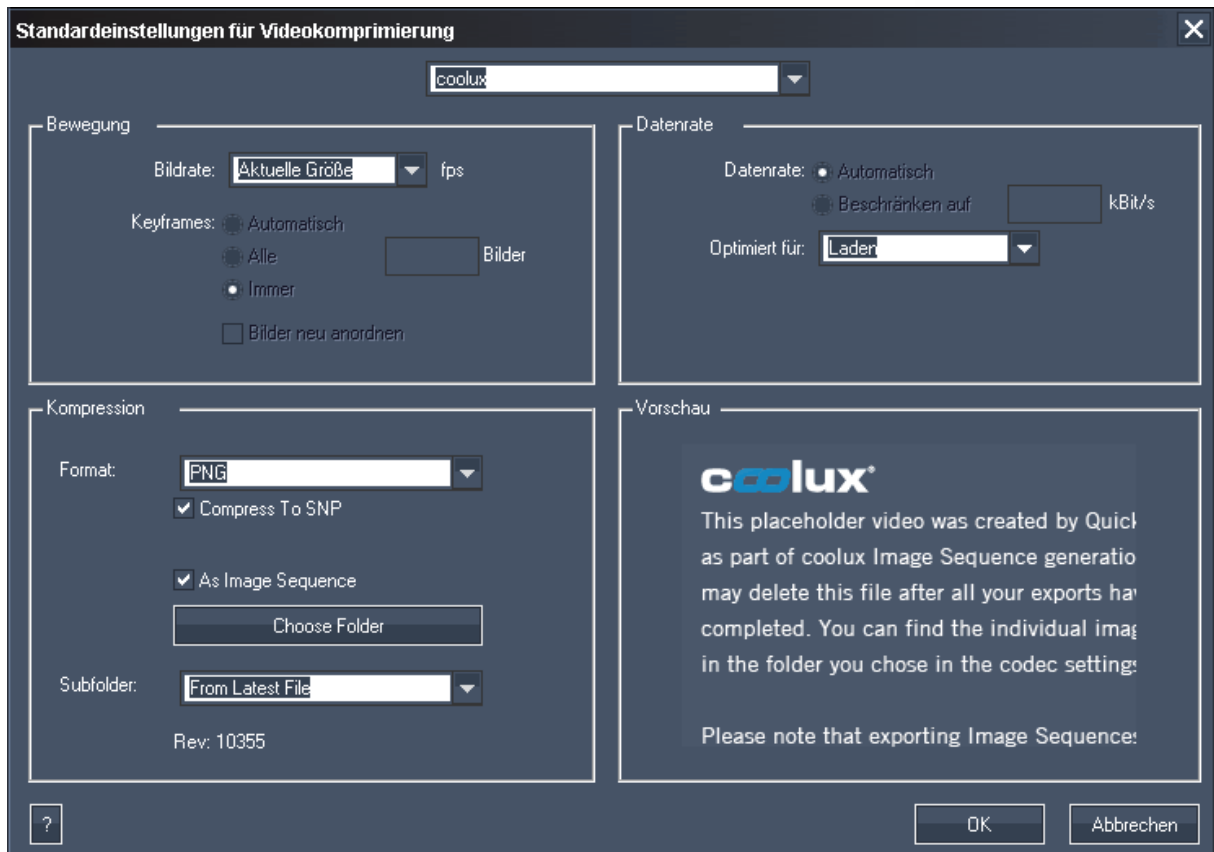

In the "Standard Video Compression Setting" dialog there is a drop-down list to select a codec. All the standard as well as third-party video codecs installed on your system are available. Select "coolux". Now, three sections "Motion", "Data Rate" and "Compression" offer adjustments influencing the quality of your export. Define the "Frame Rate" of your exported movie only if you like to change the original one. The "Data Rate" should be set to be optimized for Upload. The Compression settings are explained in the next paragraph.

## How to export a .mov file based on the coolux codec?

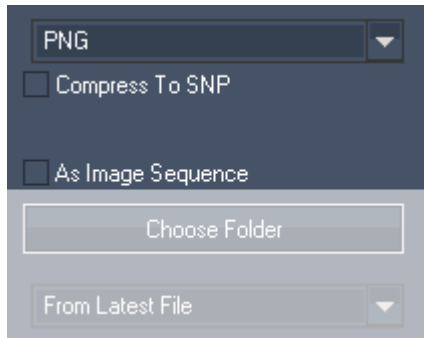

Follow the above steps until you reach the section "Compression" in the "Standard Video Compression Setting" dialog. To convert your source .mov file into a .mov that uses the coolux codec (recommended for Pandoras Box playback), follow these steps:

1) Choose the [image format](#)<sup>[98]</sup>: .dds, .png, or .bmp (in short: .dds compresses the most and allows the best playback performance, .png compresses the file size but not the image quality but generally needs more performance whilst .bmp is uncompressed but demands most performance). Choose the alpha version if your source file consists of transparent parts.

The image format mainly influences the quality of your content. The coolux codec simply renders single frames and bundles them into a mov container. There is no additional intra-frame compression!

2) Decide whether the chosen image format should be compressed (in real-time) using the [snappy compression library](#)<sup>[98]</sup>. Snappy reduces the file size but keeps the available quality. The result is a much smaller file size which is especially interesting for SSD systems as their drives normally offer less space.

3) Uncheck the option "As Image Sequence".

### Single File:

Click "OK" twice to return to the "Export As" dialog. The button "Save" starts the conversion. The result is a .mov file with the name and path chosen in the "Export As" dialog.

### Batching:

Click "OK" twice to return to the "PB Quicktime Converter" dialog that starts the conversion automatically. The result are several .mov files with the original source name in the folder chosen in the "Output Folder" text field in the "PB Quicktime Converter" dialog.

drop-down in "Standard Video Compression Setting" dialog	-
"Choose Folder" button	-
Single File) "Export As" dialog:	C:\folder A\newname.mov
Result for single converted file	C:\folder A\newname.mov
Batching) "PB Quicktime Converter" dialog:	C:\folder A\
Result for batch list item #1	C:\folder A\sourcename1.mov
Result for batch list item #2	C:\folder A\sourcename2.mov

To play the exported .mov in Pandoras Box, simply drag the file into your [Project tab](#)<sup>[248]</sup>.

To play it back without using Pandoras Box, use the Quicktime Player and install the coolux codec.

## How to export an image sequence - a folder with separate image files?

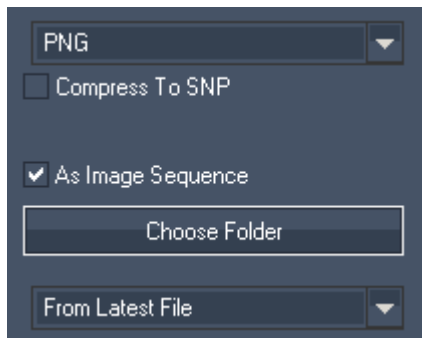

Follow the above steps until you reach the section "Compression" in the "Standard Video Compression Setting" dialog. To convert your source .mov file into an image sequence, that is a folder containing separate, sequential images, follow these steps:

1) Choose the [image format](#)<sup>[98]</sup>: .dds, .png, or .bmp (in short: .dds compresses the most and allows the best playback performance, .png compresses the file size but not the image quality but generally needs more performance whilst .bmp is uncompressed but demands most performance). Choose the alpha version if your source file consists of transparent parts.

The image format mainly influences the quality of your content. The coolux codec simply renders single frames and bundles them into a mov container. There is no additional intra-frame compression!

2) Decide whether the chosen image format should be compressed (in real-time) using the [snappy compression library](#)<sup>[98]</sup>. Snappy reduces the file size but keeps the available quality. The result is a much smaller file size which is especially interesting for SSD systems as their drives normally offer less space.

3) Check the option "As Image Sequence". Now, the images are not bundled into a mov container but will be rendered as separate image files into a folder.

4) Choose a folder where the folder(s) should be saved that contains the separate images. It is a good workflow to choose the folder where the .mov file is exported as well. That was the step in the "Export As" dialog or "Output Folder" text field in the first "PB Quicktime Converter" dialog. In both cases, the image sequence folder will be named with the same name as the .mov.

### Single File:

Click "OK" twice to return to the "Export As" dialog. The button "Save" starts the conversion. The result is a image sequence folder with the name and path chosen in the "Export As" dialog.

### Batching:

Click "OK" twice to return to the "PB Quicktime Converter" dialog that starts the conversion automatically. The result are several image sequence folders with the original source names, all in the folder chosen in the "Output Folder" text field in the "PB Quicktime Converter" dialog.

drop-down in "Standard Video Compression Setting" dialog	From Latest file	
"Choose Folder" button	choose where you saved the mov file (e.g. C:\folder A)	
Single File) "Export As" dialog: C:\folder A\newname.mov		
Result for single converted file	C:\folder A\newname.mov C:\folder A\...hst	(these files can be deleted)
	C:\folder A\newname\newname_[00000001].png C:\folder A\newname\newname_[00000002].png etc.	
Batching) "PB Quicktime Converter" dialog: C:\folder A\		
Result for batch list item #1	C:\folder A\sourcename1.mov C:\folder A\...hst	(these files can be deleted)
	C:\folder A\sourcename1\sourcename1_[00000001].png C:\folder A\sourcename1\sourcename1_[00000002].png etc.	
Result for batch list item #2	C:\folder A\sourcename2.mov C:\folder A\...hst	(these files can be deleted)
	C:\folder A\sourcename2\sourcename2_[00000001].png C:\folder A\sourcename2\sourcename2_[00000002].png etc.	

drop-down in "Standard Video Compression Setting" dialog	Unique Number	
"Choose Folder" button	choose where you saved the mov file (e.g. C:\folder A)	
Single File) "Export As" dialog: C:\folder A\newname.mov		
Result for single converted file	C:\folder A\newname.mov C:\folder A\...hst	(these files can be deleted)
	C:\folder A\folder A_[001]\folder A_[001_00000001].png C:\folder A\folder A_[001]\folder A_[001_00000002].png etc.	
Batching) "PB Quicktime Converter" dialog: C:\folder A\		
Result for batch list item #1	C:\folder A\sourcename1.mov C:\folder A\...hst	(these files can be deleted)
	C:\folder A\folder A_[001]\folder A_[001_00000001].png C:\folder A\folder A_[001]\folder A_[001_00000002].png etc.	
Result for batch list item #2	C:\folder A\sourcename2.mov C:\folder A\...hst	(these files can be deleted)
	C:\folder A\folder A_[002]\folder A_[002_00000001].png C:\folder A\folder A_[002]\folder A_[002_00000002].png etc.	

drop-down in "Standard Video Compression Setting" dialog	None (All Files in Main)	
"Choose Folder" button	choose where you saved the mov file (e.g. C:\folder A)	
Single File) "Export As" dialog: C:\folder A\newname.mov		
Result for single converted file	C:\folder A\newname.mov C:\folder A\...hst	(these files can be deleted)
	C:\folder A\folder A_[00000001].png C:\folder A\folder A_[00000002].png etc.	
Batching) "PB Quicktime Converter" dialog: C:\folder A\		
Result for batch list item #1	C:\folder A\sourcename1.mov C:\folder A\...hst	(these files can be deleted)
	C:\folder A\folder A_[00000001].png C:\folder A\folder A_[00000002].png etc.	
Result for batch list item #2	C:\folder A\sourcename2.mov C:\folder A\...hst	(these files can be deleted)
	C:\folder A\folder A_[00000001].png C:\folder A\folder A_[00000002].png etc. Note that this overwrites the files from the first batch item!	

To playback the image sequence in Pandoras Box, right-click on the folder in the Assets tab, and choose "Import As Image Sequence".  
To play it back without using Pandoras Box, use a media player that supports image sequences.

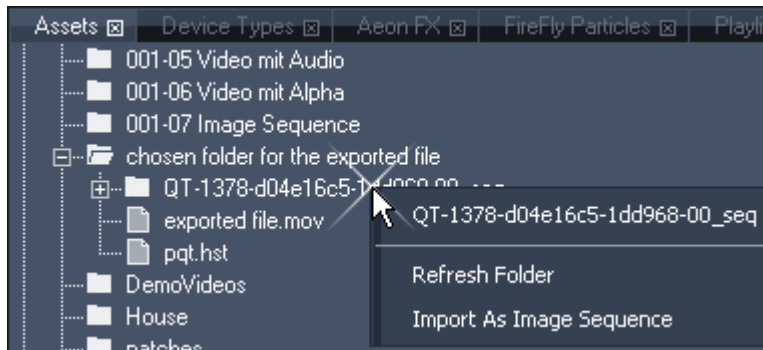

## 5.2 USER INTERFACE - MASTER

This chapter explains the user interface of a Pandoras Box Master system. The [Client's interface](#)<sup>294</sup> is covered in the next chapter. The chapter [Master / Client Remote Setup](#)<sup>647</sup> explains the general difference between a PB Master and PB Client, how to connect them and how to include a Client device in your Master project.

To ensure an easy learning curve throughout all Pandoras Box products, we have created a unique user interface design. Importantly, the user interface of each Pandoras Box product looks identical. This image includes links to different chapters, please click on the tab to read its respective description. The tabs not included in the default view can be found in the topic "[Tabs Overview](#)<sup>134</sup>".

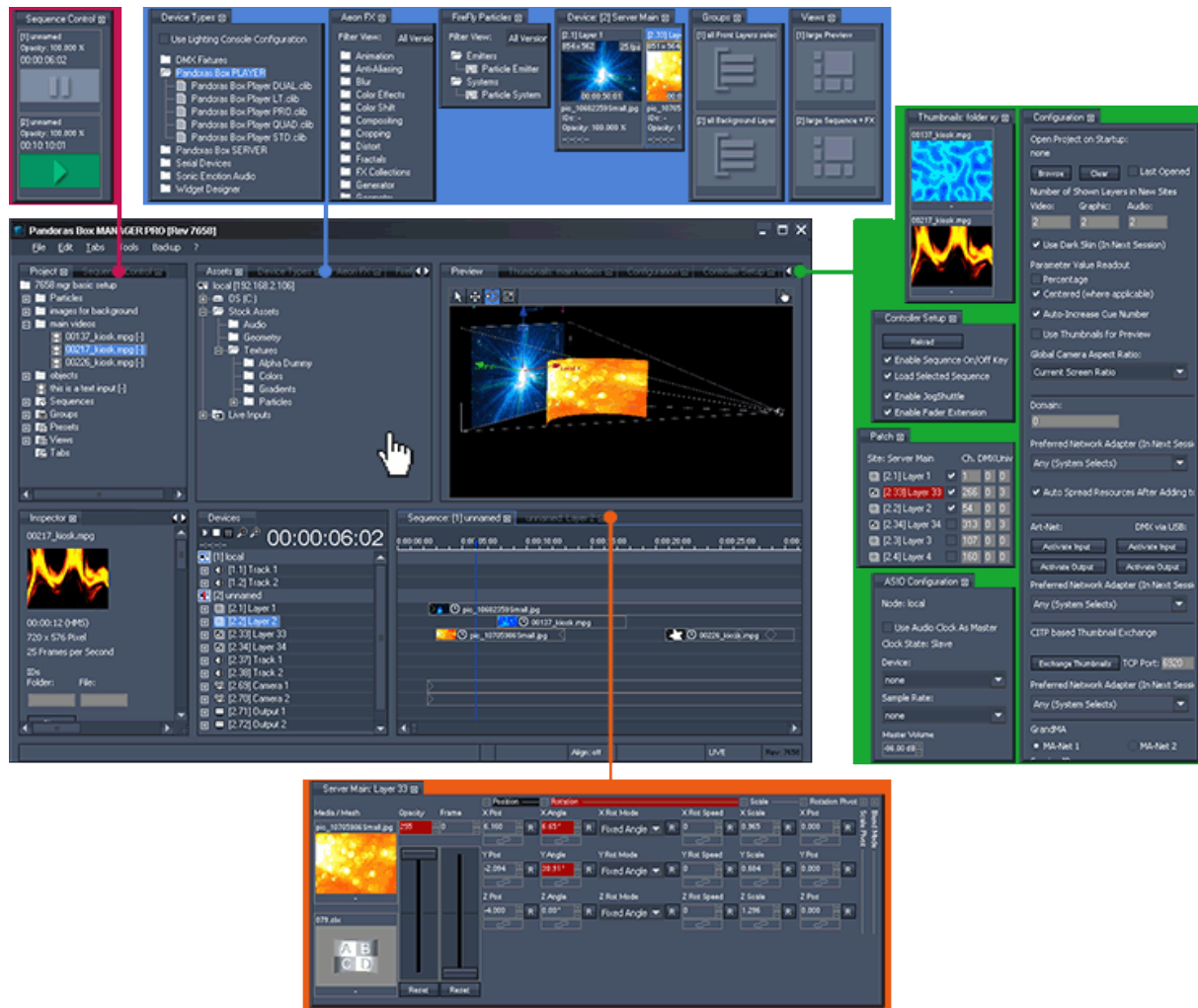

The user interface is designed for real-time playback and operation; therefore all important functions are accessible directly through a tab and view oriented workflow.

Pandoras Box supports a dynamic context-menu structure. A right-click on a particular item opens a context sensitive menu and shows the corresponding commands.

Of course the entire user interface layout can be customized to meet your needs. The tabs size and location can be adjusted either within the main frame or independently on the entire desktop area as a so called breakout pane. You may [store several views](#)<sup>286</sup> and recall them with one click at any time

during operation.

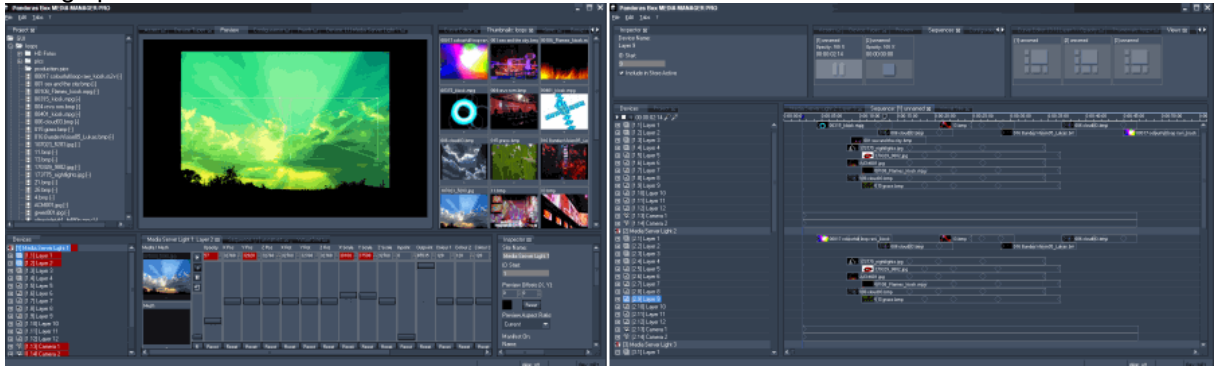

Tabs with customizable commands are available as well. Add your own buttons to the tab and assign a desired command in order access it faster.

The Master User Interface section is divided into these themes:

[Startup Dialog](#)<sup>129</sup>: explains the menus File, Edit, Tabs, Tools and Backup seen in the top

[Menu Bar](#)<sup>129</sup>: explains the menus File, Edit, Tabs, Tools and Backup seen in the top

[Layout](#)<sup>290</sup>: illustrates how to influence and rearrange the look of the user interface

[Tabs Overview](#)<sup>134</sup>: gives an overview on each visible and hidden tab

[Keyboard Shortcuts](#)<sup>292</sup>: includes all shortcuts existing in the master version of Pandoras Box

## 5.2.1 STARTUP DIALOG

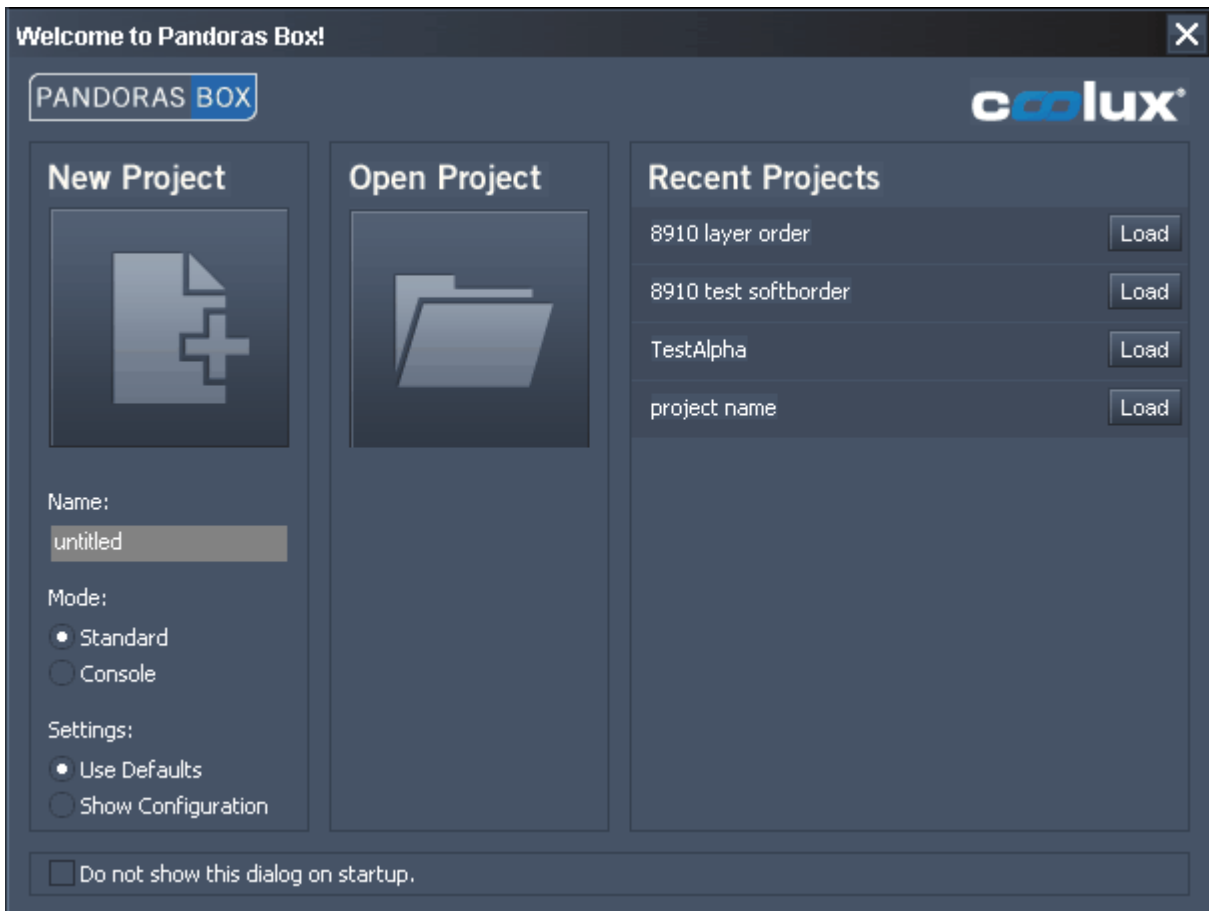

---

With version 5.5 a Startup Dialog was introduced. It gives you the possibility to start fast with the project of your choice, you may load a new project, a recent project or one from the directory.

On the left side you may choose to open a new project. If necessary, change the default settings and then click the button.

- Name: Enter a name for your project. It will appear in the [Project tab](#)<sup>248</sup> and will be the file name when you later on save the project to a directory of your choice. Until you do so, the project is temporarily saved under "C:\coolux\content\projects\temp\_projects\temp".
- Mode: Decide to load a standard project or one that has optimized settings for being remote controlled by a [lighting console](#)<sup>181</sup>.
- Settings: Choose whether the default settings should be applied or whether a pop-up should show the [Configuration tab](#)<sup>139</sup> first to let you decide particular settings.

The button in the middle opens a dialog where you can choose the directory from where to load an existing project.

The right side shows a list of recently saved or opened projects. Simply click on the "Load" button next to a name.

Click the check box at the bottom if you do not like to display this dialog on the next startup. The same option can be found in the Configuration tab > [Startup](#)<sup>149</sup>.



## 5.2.2 MENU BAR

The menu bar on top of your Pandoras Box Software contains the following application menus:

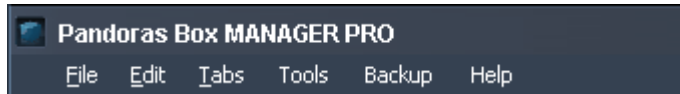

- [File Menu](#)<sup>129</sup>
- [Edit Menu](#)<sup>130</sup>
- [Tabs Menu](#)<sup>131</sup>
- [Tools Menu](#)<sup>132</sup>
- [Backup](#)<sup>132</sup>
- Help (?)

### 5.2.2.1 FILE MENU

The file menu allows you to achieve all project related actions.

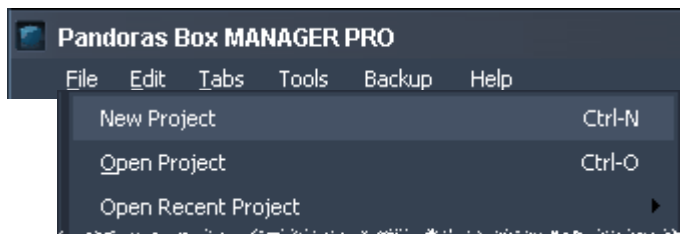

#### [New Project]

Click here to create a new project. Before leaving the current project you will be asked if you want to store the current project. You will have to choose if you want to create a project in Standard Mode (shortcut: CTRL-N) or in [Lighting Console Mode](#)<sup>181</sup>.

#### [Open Project]

Click here (or use CTRL-O) to open an existing project.

#### [Open Recent Project]

Open a list with recently used projects.

#### [Save Project]

Click here (or use CTRL-S) to save the current project.  
Please note: There is no auto-save function!

#### [Save Project As]

Click here (or use CTRL-Shift-S) to save the current project under a different name and go on working in the renamed project.

#### [Save Project Copy]

Click here (or use CTRL-Shift-Alt-S) to save a copy of the current project and go on working in the current project.

#### [Bundle Project]

Click here (or use CTRL-Shift-B) to bundle your project under a new name and location. All content used in the timeline will be copied to the new location in a folder called "Assets" next to the show file. This option allows you to only have one folder to archive your show on an external hard drive. To play your show again, just copy this folder at its original location on your hard disk and all paths will be recovered.

Since version 5.5 Pandoras Box supports a relative path whereto content can be saved. When saving a project a folder named "assets" is generated just next to the show file. If you copy content files to that folder and drag them from here into your Pandoras Box project the content links are relative. That means that you can move the project folder ( including the \*.xml and asset folder) to every path wanted without the need of re-linking the content.

As bundling the project creates an assets folder as well, you can copy the bundled folder wherever you like to. As all paths are relative paths, Pandoras Box is able to load all the content. It will not become inconsistent any more.

[Close Project]

Click here (or use CTRL-W) to close the current project.

[Remove Unused Resources]

Click here to remove all content files from your project that are not used in the timeline.

[Exit]

Click here (or use CTRL-Q) to Exit Pandoras Box. You will be asked if you want to store your project if there are not stored changes.

### 5.2.2.2 EDIT MENU

The edit menu allows you to execute the following commands. Most commands influence the [Sequence tab](#)<sup>260</sup> and the [Device Tree tab](#)<sup>168</sup> and can be found in the respective context menus as well.

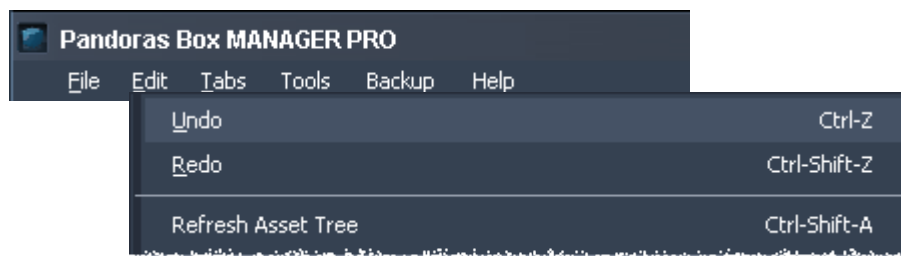

[Undo]

Undoes a step of sequence editing as well as changes in project tab. Actions that are not stored to the timeline like changing a value on fader cannot be undone.

[Redo]

Redoes a step of sequence editing as well as changes in project tab.

[Refresh Asset Tree]

If any changes have been made on the local hard disc system, you have to refresh the File Tree in the Asset Tab to see these changes inside Pandoras Box. Please note that refreshing the whole tree will close all subfolders and you have to open them again. See the [Asset tab](#)<sup>137</sup> to get information about how to refresh single subfolders.

[All Active]

Sets all parameters to the active status.

[Clear All Active]

This command clears all active parameters.

[Reset All]

Resets all parameters to their default values and removes their active status.

[Store Active]

Stores all active parameters as containers to the sequence.

[Store Active (Selected Devices)]

In contrast to the above command, this one filters active values for those devices (layers) that are selected. The values are stored at the current time at the blue nowpointer. All active values influencing other layers will stay active.

[Store Active To Time]

A small dialog opens and asks for the time whereto all active values will be stored. The time can be entered in the format H:MM:SS:FF or shortened to SS:FF or even SFF. So, for example 3 seconds can be 0:00:03:00 or 03:00 or 300. Click Enter or the button [Ok] to close the dialog and save the active values.

[Copy]

Saves an selected item, for example a key or a clip container from the sequence.

[Paste]

Pastes the copied selection to the device where it was copied from in the Sequence Tab.

[Paste to Selected Devices]

Pastes the copied selection (keys, clip containers) to other devices in the Sequence Tab. To do this, select one or more devices holding down SHIFT or CTRL. Please see [Sequence](#)<sup>260</sup> for detailed selection information.

[Cut]

Cuts out an selected item, for example a key or a clip container from the sequence.

[Trim Left]

This applies to a selected container, it erases everything between the nowpointer and the left clip boarder. The last key of a parameter before the nowpointer will be moved to the new clip boarder time. The video clip will now be shortened at the beginning.

[Trim Right]

This applies to a selected container, it erases everything between the nowpointer and the right clip boarder. There will be a new key set at the right clip boarder containing the value a parameter had at the nowpointer before.

[Trim To Clip Borders]

If a clip container was scaled down, there could be hidden keys beyond the clip borders. This command removes these hidden keys and sets new keys at the left and right clip border to ensure the wanted behavior in the visible part of the clip.

[Add Cue at Current Time]

Adds a cue at the current time, indicated by the blue nowpointer. Click onto the cue to select it and see its [properties in the Inspector tab](#)<sup>204</sup>.

### 5.2.2.3 TABS MENU

The tabs menu allows you to open / reopen all tabs in the user interface. Each tab is explained in detail in the topic "[Tabs Overview](#)"<sup>134</sup> and "[User Interface](#)"<sup>126</sup>.

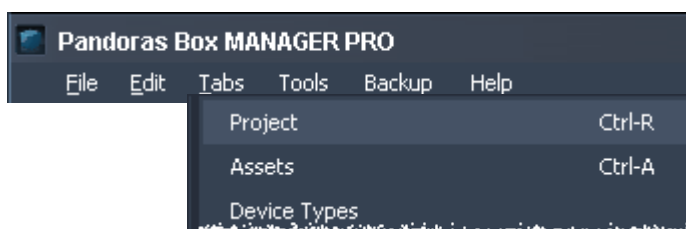

**Please note:**

There is no option to open a preview tab, because you can not close this tab (running a PB preview version). If you are running a non-preview manager version, you do not have a preview tab at all.

The Extension drop-out includes all extensions that are available like the Encoder Extension and Comulite. The Encoder Extension is only available on certain Pandoras Box products, please see the chapter "[Product Overview](#)<sup>[65]</sup>".

### 5.2.2.4 TOOLS MENU

The Tools menu allows you starting the additional tools from within the Pandoras Box master software:

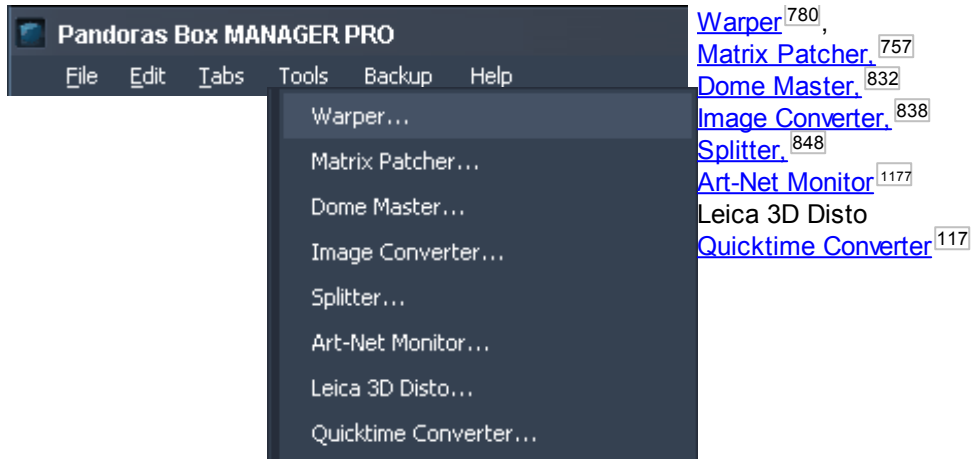

### 5.2.2.5 BACKUP MENU

The backup menu allows you to run a second master as backup device in the same domain as the "show" master device without causing any conflict. As long as this device is in Backup Mode, it won't give out any control data.

If it is necessary to change over to the backup device, this backup master may take over all sites in the domain in order to run the show.

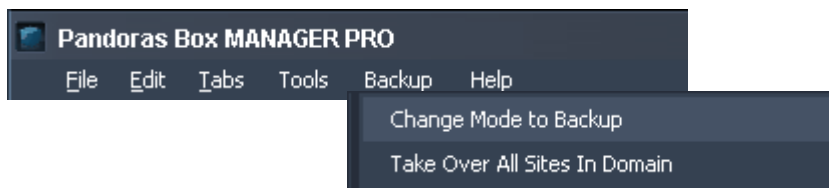

To change a master into backup mode, go to the Backup menu and choose "Change Mode to Backup". The status line at the bottom of the user interface displays "Backup" highlighted in orange instead of "Live". When you have to change over to Show Mode, choose "Take Over All Sites In Domain" from the Backup Menu.

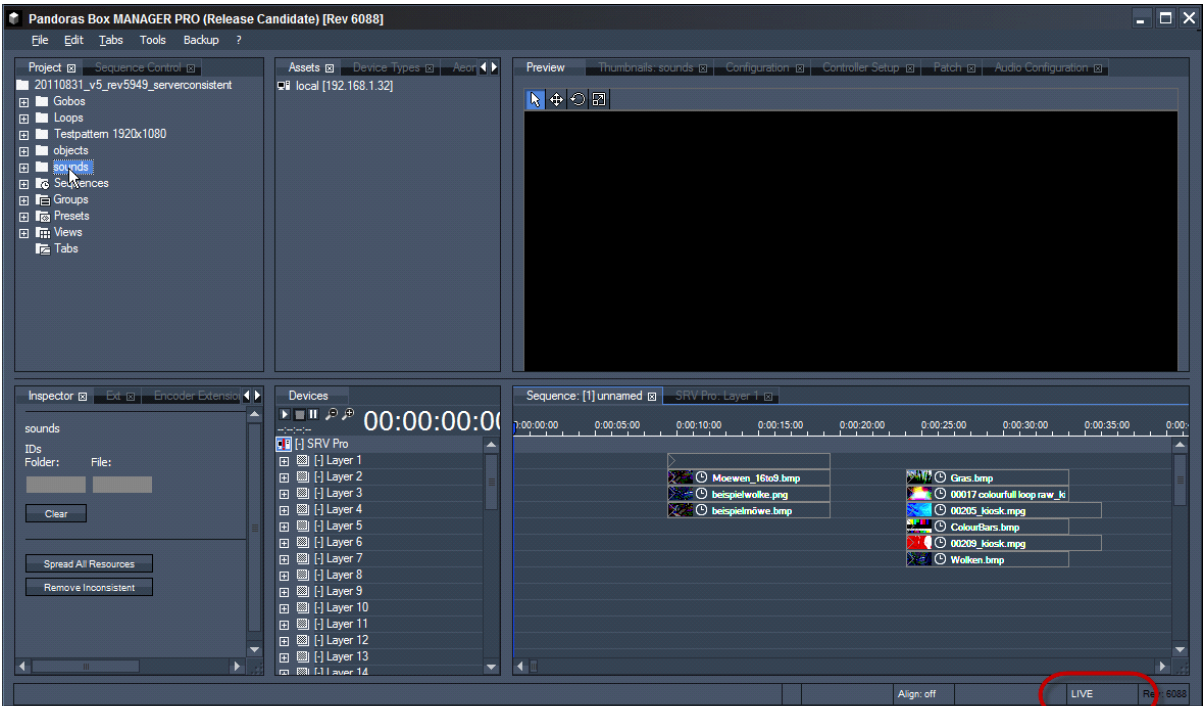
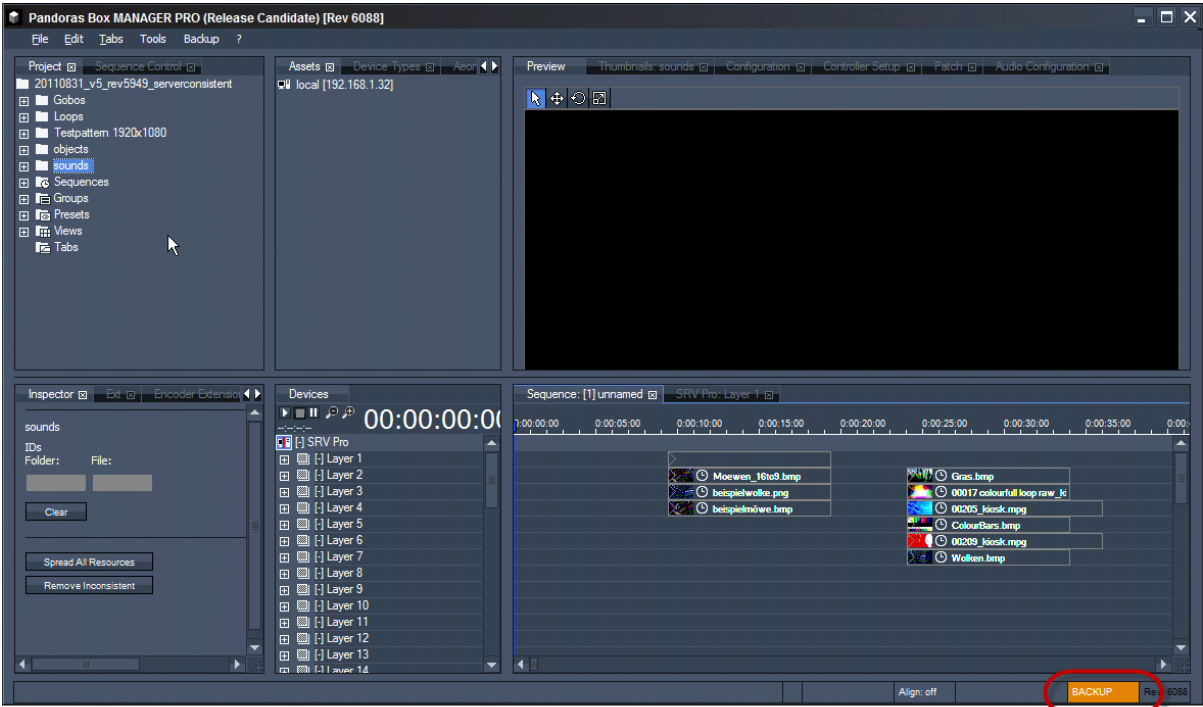

Images: The status bar at the bottom of the user interface shows:  
Top) Manager in Backup Mode, Bottom) Manager in Live Mode.

## 5.2.3 TABS OVERVIEW

In this chapter information about each tab in the user interface may be found.

See here the list of all available tabs in the PB Master Device. A picture with all tabs available in the default view can be seen in the chapter "[User Interface](#)<sup>126</sup>". If you are not familiar with the names, it might be of interest for you, that it includes integrated links to each tab, simply click on one tab.

- [Active Values](#)<sup>135</sup>
- [Aeon FX](#)<sup>136</sup>
- [Assets](#)<sup>137</sup>
- [Configuration](#)<sup>139</sup>
- [Controller Setup](#)<sup>159</sup>
- [Curve Editor](#)<sup>161</sup>
- [Device Control](#)<sup>164</sup>
- [Device Tree](#)<sup>168</sup>
- [Device Types](#)<sup>181</sup>
- [Device Viewer](#)<sup>182</sup>
- [Encoder Extension](#)<sup>182</sup>
- [FireFly Particles](#)<sup>182</sup>
- [Groups](#)<sup>251</sup>
- [Group View](#)<sup>187</sup>
- [Inspector](#)<sup>188</sup>
- [Media Encryption](#)<sup>216</sup>
- [Patch](#)<sup>222</sup>
- [Presets](#)<sup>253</sup>
- [Preset View](#)<sup>230</sup>
- [Preview](#)<sup>232</sup>
- [Project](#)<sup>248</sup>
- [Sequence](#)<sup>260</sup>
- [Sequence Control](#)<sup>273</sup>
- [Tabs](#)<sup>258</sup>
- [Taskmanager](#)<sup>275</sup>
- [Text Input Editor](#)<sup>277</sup>
- [Thumbnail Viewer](#)<sup>280</sup>
- [Video Export](#)<sup>281</sup>
- [Video Recording](#)<sup>284</sup>
- [View Tab](#)<sup>286</sup>
- [Virtual Site](#)<sup>286</sup>

### 5.2.3.1 ACTIVE VALUES

Device parameter values are designed to have different states: Active and Inactive.

As you edit and change device parameter values from within the device tree or device control tab, all manually changed values will be activated and highlighted in red.

The active value state of a parameter value indicates the changes you have made but not stored yet. Therefore any store operation within Pandoras Box will be based on the active values only.

Active values are always displayed in red everywhere in the user interface until the values are either stored to a preset or sequence, reset to default or simply deactivated. As long as there are active values for a parameter, all values that have previously been stored in the timeline will be ignored until you store or reset these active values.

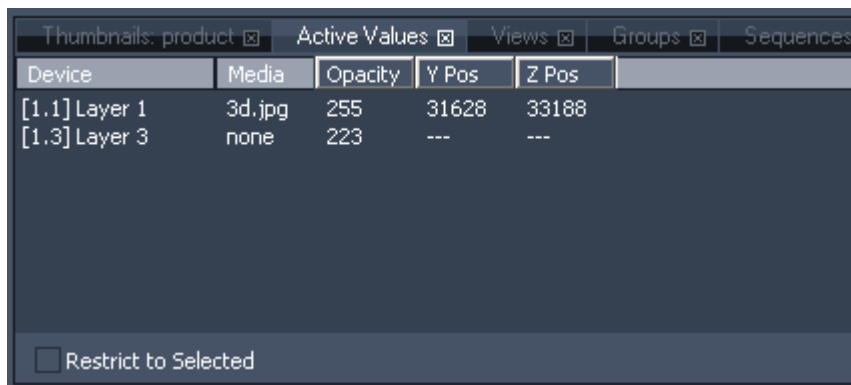

The Active Values tab lists all currently active values. This gives you an overview of all changes you made since the last store operation.

To see all active values of the selected devices only, check [Restrict to Selected] at the bottom of the Active Values Tab.

By left-clicking on the values in the Active Values tab you may apply direct changes to any parameter value.

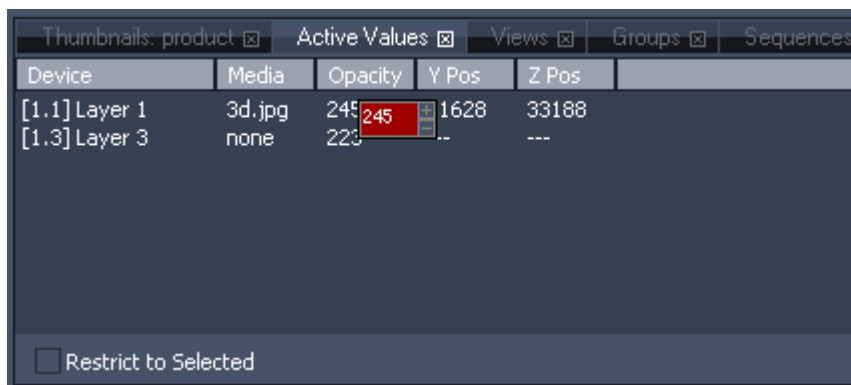

This concept is particularly useful if you do not want to mess around with programmed timeline values and change values only temporarily for creation and setup.

To reset a value right-click on the desired parameter and choose "Reset". In the right click menu it is also possible to activate parameters or to clear active parameters.



Every reset command will deactivate the active values based on the reset target.

**5.2.3.2 AEON FX**

The AEON FX tab allows choosing between varieties of different effects.

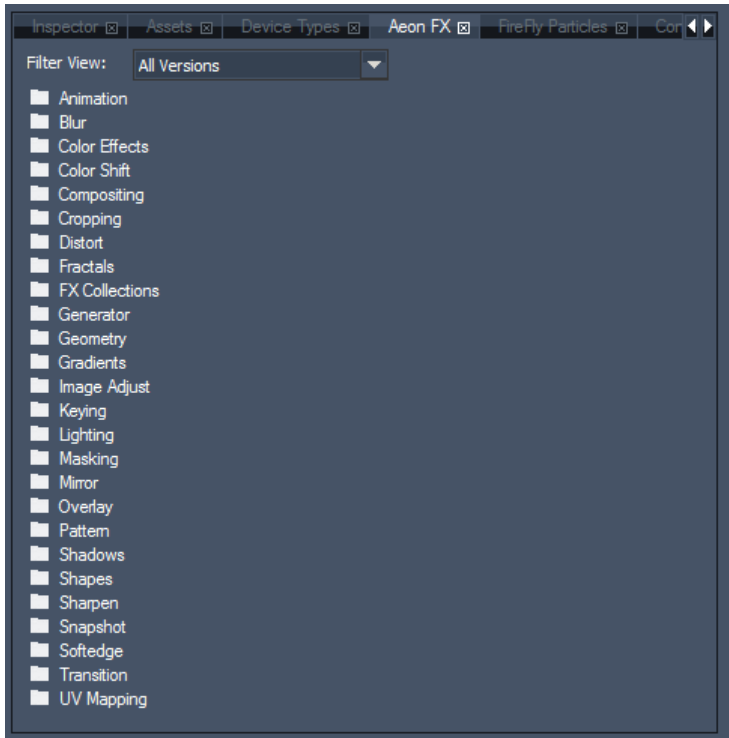

Depending on your PB Device, different FX are available. Choose your PB Device from the Filter View drop-down list (Player LT / Player STD / Player PRO / Dual Player / Quad Player or all kind of Servers).

Now all available FX can be found inside the FX folders, sorted by themes.



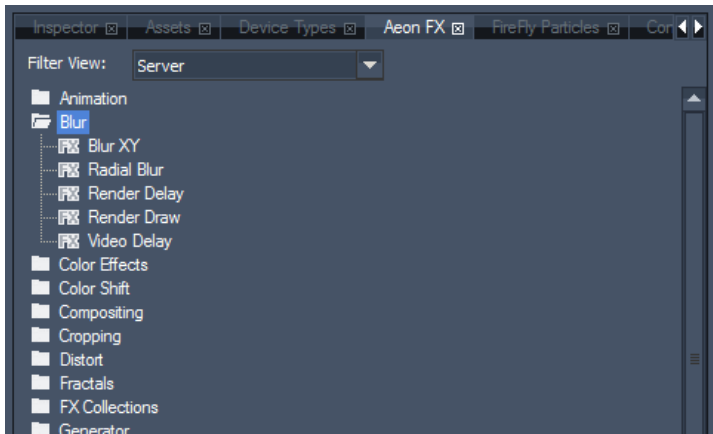

The FX may be assigned to video and graphic layers and to the outputs. To do this, choose the effect and drag and drop it onto the device, or select the device (it will be highlighted in blue) and execute a double-click on the desired effect.

The [FX list](#)<sup>328</sup> shows all FX that are included in the FX theme collections as well as the availability of the effects for the different PB products.

### 5.2.3.3 ASSETS



The Asset Browser tab has two main functions:

1. Import files from any available file system
2. Load available Client devices into the device tree of the current project.

#### FILE IMPORT

Files are imported from the asset tree by drag and drop into the project tab.

The best way to import files is to get these exclusively from the local hard disc system of the Master system. This is especially useful, if you want to transfer show files to other systems later on for backup scenarios or other purposes.

Even though you may import files from client systems as well, it is important to know that each time you import a file; the source location will be used as a reference for remote file management.

When a file is imported to the project tab, it will be shown as a link to the file system.

To view the properties of the imported file, click on the inspector and after that on the desired file. Then you can see the file location on the systems.

All files will automatically be spread (copied) to all connected clients by default. To change this spreading mode into a manual mode, please see [Configuration > Resources](#)<sup>[141]</sup>.

Since live input cards are treated as live video textures, please import your live input sources from the asset browser as well. Each listed client will list its live inputs that are available for import.

### CLIENT IMPORT

Once the Master and Clients are started and set up, they can communicate via the same domain channel.

To check if a Client can be connected with a Master system, the Client should be in the same IP address range and on the same domain channel. Once this is set up, the Client will display the Masters IP address in its main user interface window.

The Master system will then show all available Clients in the asset browser.



To import a Client from the asset browser, simply drag and drop the unit from the asset list into the device tree of the Master GUI.

The device IP information and properties will be stored from now on with the current project.

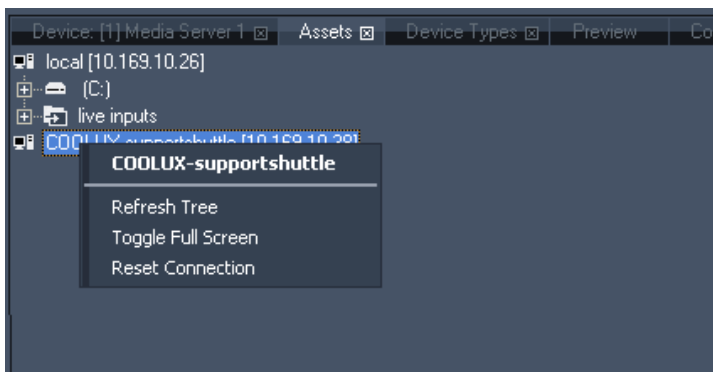

A right click on a Client lets you refresh the whole Client Tree. You can toggle the Client into or out of the fullscreen. If the connection between Master and Client was disconnected, choose [Reset Connection] to recover this Client device.

Please note:

If any changes have been made on the local hard disc system, you have to refresh the folder containing these changes. Do this either by

- selecting the changed folder and pressing [F5],
- by doing a right click on your local folder and choose 'Refresh Tree' or

- by doing a right-click on the drive containing the changes and choosing 'Refresh Drive' or
- by doing a right-click on a folder and choose 'Refresh Folder'.

Please note that refreshing the whole tree, a drive or a folder will close all subfolders and you have to open them again.

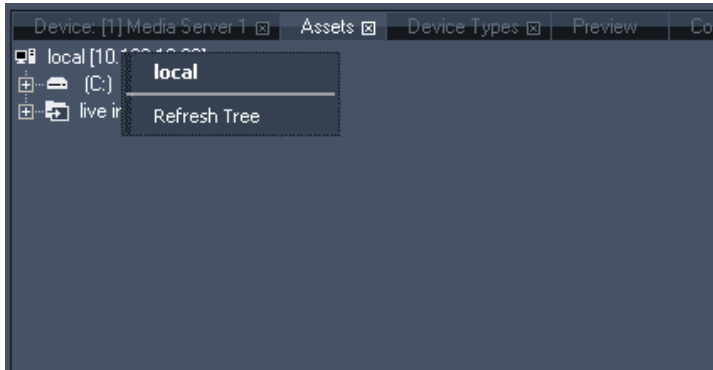

### 5.2.3.4 CONFIGURATION

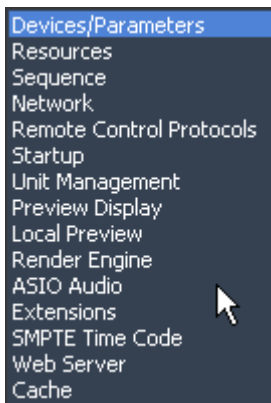

The Configuration tab is divided in several sections, each described in detail on the following pages:

- [Devices / Parameters](#)<sup>139</sup>
- [Resources](#)<sup>141</sup>
- [Sequence](#)<sup>144</sup>
- [Network](#)<sup>146</sup>
- [Remote Control Protocols](#)<sup>146</sup>: e.g. DMX, Art-Net, Midi...
- [Startup](#)<sup>149</sup>
- [Unit Management](#)<sup>149</sup>
- [Preview Display](#)<sup>151</sup>
- [Local Preview](#)<sup>153</sup>
- [Render Engine](#)<sup>153</sup>
- [ASIO Audio](#)<sup>156</sup>
- [Extensions](#)<sup>157</sup>
- [SMPTE Time Code](#)<sup>157</sup>
- [Web Server](#)<sup>158</sup>
- [Cache](#)<sup>159</sup>

#### 5.2.3.4.1 DEVICES / PARAMETERS

The section "Devices / Parameters" in the [Configuration tab](#)<sup>139</sup> enables you to set up the general appearance and behavior of devices and parameters in your project.

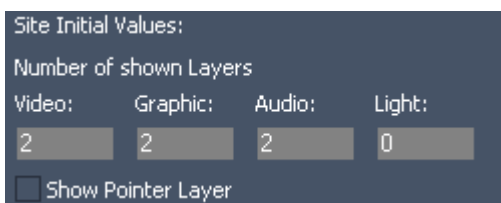

#### Site Initial Values

- Number of Shown Layers in New Sites
  - Show Pointer Layer
- Enter the amount of [layers](#)<sup>296</sup> that should appear when a new site is added to the Devices tab. Choose whether it shows the Pointer Layer or not.

All other layers are hidden to ensure a good overview. To unhide or add additional layers to an existing site, right-click on the site. (see "[Site context menu](#)"<sup>172</sup>.)

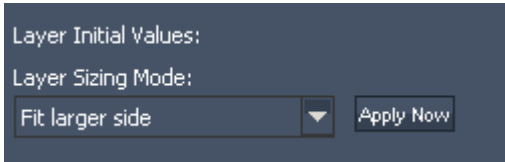

### Layer Initial Values

- Layer Sizing Mode  
Choose the [Layer Sizing Mode](#)<sup>208</sup> that should be applied for newly added layers, e.g. whether they should be stretched fullscreen or keep their original resolution.

Click "Apply now" if already existing layers should adopt that mode.

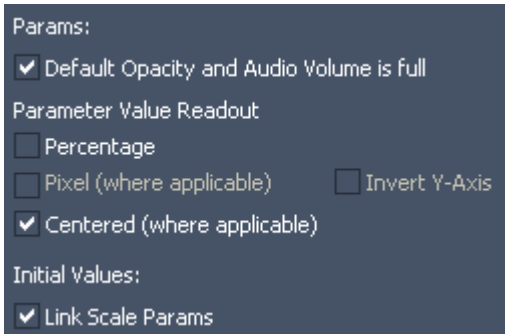

### Params

- Default Opacity and Audio Volume is full  
When checked, the default value for Opacity is 255 and for Volume it is 0dB, i.e. both are at 100%. This means that as soon as a media file is assigned to a layer, it will be visible or hear-able. When a container is created, and no key for Opacity / Volume is generated, the default value takes place.

In Versions before 5.5 the default value has been 0. If you like to return to that behavior you may uncheck this option.

Please note that this option results in a different show appearance when switched during or after show programming, thus it is recommended to test the show or check this option only once before starting to program.

- Parameter Value Readout

-- Percentage

Use the check box to enable percentage readout for all values of all parameters in the project, see figure b) and c). This setting can be changed at any time during runtime.

-- Pixel (where applicable)

This option is available, if the [Unit Translation Mode](#)<sup>149</sup> is changed to "Use Fixed Relationship".

Some parameters (like Position and most Camera parameters) are then based on pixel values. This makes it possible to enter an exact pixel number, e.g. move right by 50 pixels.

By default, the positive X-axis points to the right direction and the Y-axis to the top. If you like to have the Y-axis pointing down, check the option "Invert Y-Axis".

-- Centered (where applicable): Some of the parameter values appear in centered position by default (default value is here set to 0), irrespective if the readout is decimal or percentage, e.g. the following parameters: X/Y/Z Rotation Speed of a Layer, Keystone faders of an Output. If you disable this function, 0 will be the minimum and the 8 bit /16 bit decimal value (depending on the properties of each parameter) will be the maximum value. With percentage value readout the value range goes from 0 to 100%. Please note that the value parameter or the layer appearance is not changed, it is just a way of displaying the value.

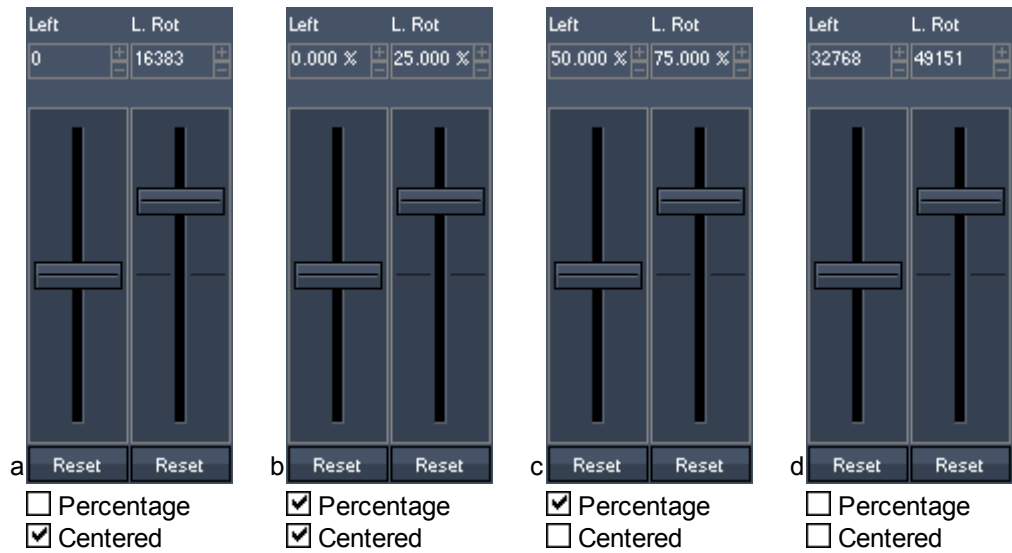

- Initial Values (for Parameter)  
 Check the option "Link Scale Params" if all newly added layers should have a locked aspect ratio. If you now change the X Scale, the Y and Z scale follow.  
 For existing layers, you can link parameters by using the chain icon underneath the parameter fields, see [Device Control tab](#)<sup>164</sup> and [Linking Parameters](#)<sup>165</sup>.

**5.2.3.4.2 RESOURCES**

The section "Resources" in the [Configuration tab](#)<sup>139</sup> enables you to set up the general settings for resources to improve your workflow. In addition you can influence the (initial) properties of specific resources like videos, image sequences and others.



**General**

- Set maximum DMX File / Folder ID to 255  
 When checked, the [File ID and Folder ID](#)<sup>190</sup> can reach a maximum of 255. The next item would start with 1 (instead of 256) and a consecutive Folder ID. This option is especially useful when working with a lighting desk and / or exchanging [thumbnails via CIP](#)<sup>146</sup>.

- Auto Spread Resources after adding to Project  
 All media files added to the project will automatically be spread to all available clients (by default). To determine the time of spreading manually, uncheck this option.
- Monitor changes to files on disk  
 This applies when a file that is part of your Pandora's Box project is saved by another program under the same name, i.e has changed. In versions before 5.5 it was necessary to reload the file manually or to reload the entire PB project to load the new state of the file. Now, you can decide to monitor the hard disk and reload a file automatically as soon as it has changed. If you like to spread it too, please activate the next check box as well " Auto Spread Resources after change to file".  
 Please note that this only applies to the system from where the file was originally added to the project. If you spread a file and change it on the remote node, you will not see the updated file as the remote disk is not the source disk and was not monitored.

- Auto-Spread Resources after change to file

If a file change is monitored (see check box "Monitor changes to files on disk") it will be spread to available nodes too.

- Show Folders in Thumbnail Browser

If you click on a folder in the Project tab or Assets tab, its contained files are displayed as individual thumbnails in the Thumbnail tab. If the folder includes sub folders, they are depicted with a folder icon. If you do not like that and only wish to see the files itself, untick the check box.

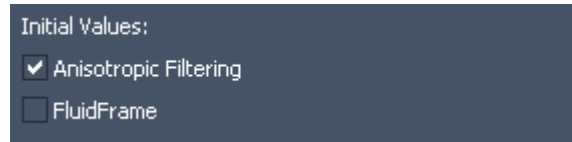

**Initial Values (for Resources)**

These options apply to newly added images, videos, playlists, etc. For more information about the settings see the [File Inspector](#)<sup>190</sup>.

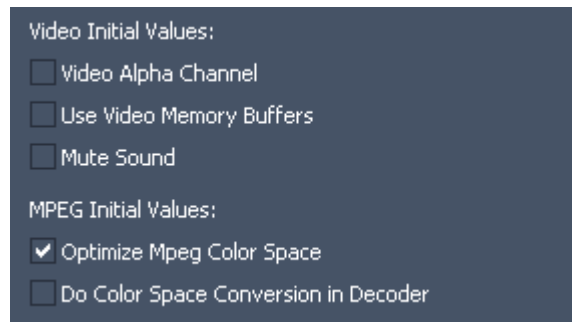

**Video Initial Values**

These options apply to newly added videos. For more information about the settings see the [File Inspector](#)<sup>190</sup>.

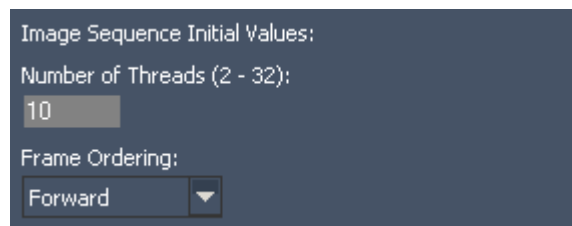

**Image Sequence Initial Values**

These options apply to newly added image sequences. For more information about the settings see the [Image Sequence Inspector](#)<sup>194</sup>.

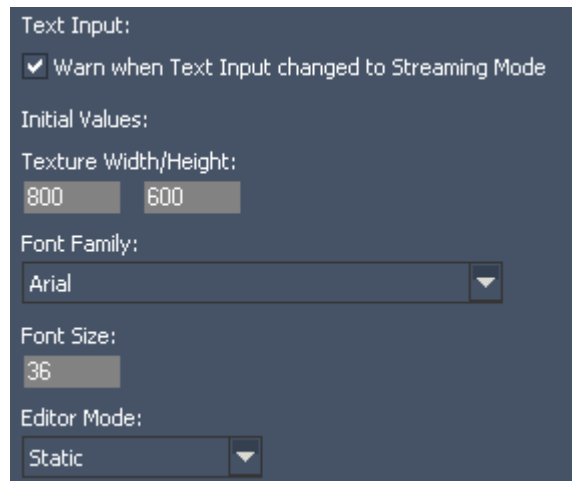

**Text Input**

Choose whether you like to be warned with a message box when a Text Input is changed from "Static" or "Scrolling" to "Streaming".

All other options apply only to newly added text assets. For more information about the text settings see the [Text Inspector Editor](#)<sup>277</sup>.

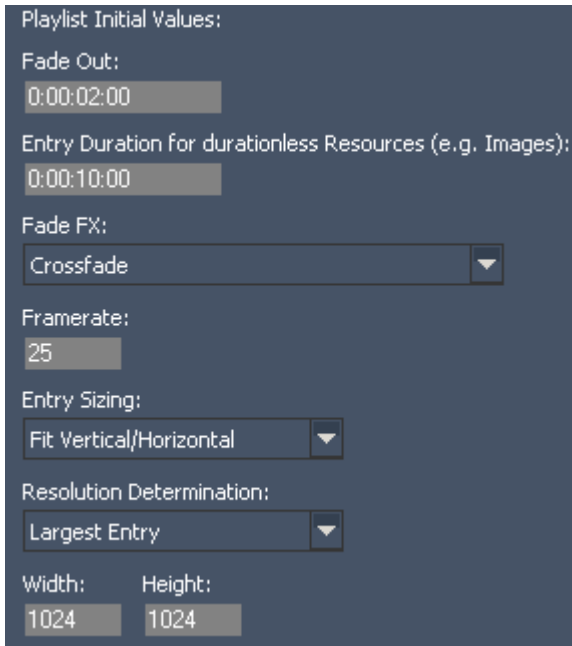

**Playlist Initial Values**

These options apply to newly added [playlists](#)<sup>229</sup>.

For more information about the settings see the [Playlist Inspector](#)<sup>196</sup>.

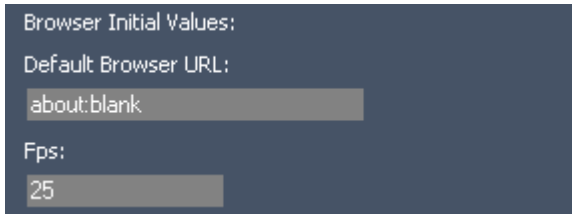

**Browser Initial Values**

- Default Browser URL:  
Enter a URL that you wish to assign to a Browser asset as soon as it is created in the Project tab, e.g. <http://www.coolux.de>

**- FPS**

Enter the frame rate a newly created Browser asset should be rendered with.

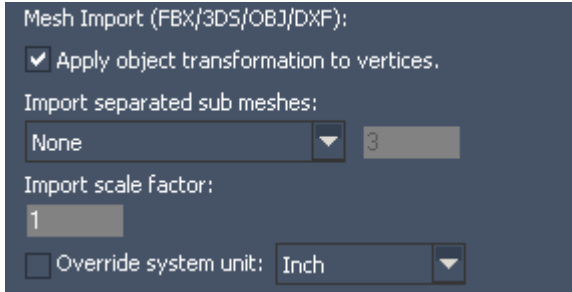

**Mesh Import Initial Values**

The following options are offered in an additional dialog as soon as you import an object. The dialog opens with the values set up in the Configuration tab.

- Apply object transformation to vertices  
This is of interest if your object was saved with sub meshes or levels and one sub mesh exists multiple times. In case you de-activate "Apply object transformation to vertices" it can happen these copied

sub meshes are imported with a different position, i.e. their own 0,0,0 origin (pivot point) has moved to the coordinate system's origin, the global 0,0,0. point.

**- Import separated sub meshes**

This is of interest if your object was saved with sub meshes or levels.  
None: The imported object consists of only one mesh. All sub meshes are merged into it.  
All: The original hierarchy is not changed. All sub meshes will be available as separate meshes. In the Project tab, double-click onto the main object and a tree structure will open with all available sub folders and sub meshes. Please note, that it is possible to use either a single sub mesh or an entire folder entry above it; the folder merges all consisting sub meshes when assigned to a Layer.  
Specifies Levels: The original hierarchy can be flattened. Enter how many levels you like to use. If the original file was saved with more "deeper" levels, they will be merged.

**-Units of measurement**

**-- Import scale factor**

Enter a scale factor for newly added meshes. For example: 0.5=half size; 2.0=double size

--Override system unit

If the "Scale factor" does not return the expected result, you may enable the option to override the system units the file was saved with. If you see this scaling issue with 3ds files, in most cases it helps to set "Inch".

### 5.2.3.4.3 SEQUENCE

The section "Sequence" in the [Configuration tab](#)<sup>139</sup> enables you to set up (initial) properties of timeline specific elements like the sequence itself, container, cues and others.

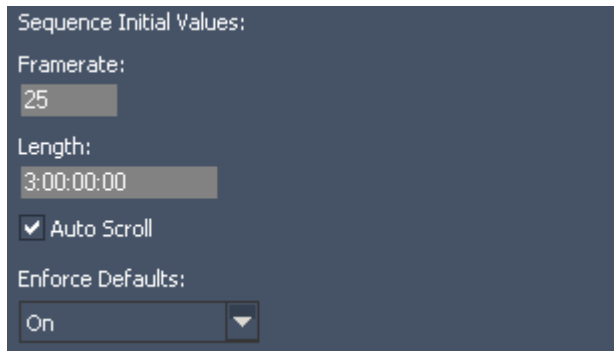

#### Sequence Initial Values

- Framerate
- Length
- Auto Scroll
- Enforce Defaults

Enter the properties that should be applied as soon as a new sequence is added to the project. For more information about these and other sequence settings see the [Sequence Inspector](#)<sup>200</sup>.

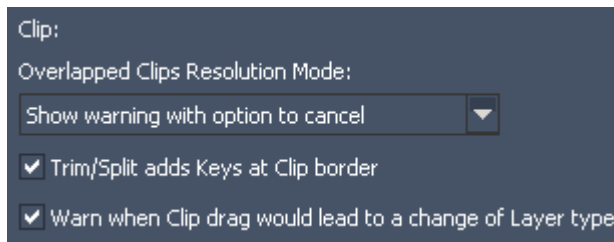

#### Clip

- Overlapped Clips Resolution Mode

When a container is being copied (or dragged) to a time where another container already exists there is a conflict. With the options from the drop-down menu you can decide how this conflict should be resolved.

- Show warning with option to cancel: A pop-up warns about the container overlap. You can choose to cut the existing container or to cancel the action.
- Cancel operation: The action that would lead to the overlap will simply not be executed. This is the same result as choosing "Cancel" in the above mentioned pop-up.
- The existing container will be cut at the beginning and/ or end of the pasted container. This is the same result as choosing "Ok" in the above mentioned pop-up.

- Trim / Split adds Keys at Clip border

When you trim a container or split it, per default a new key is added at the new container end. Image, that you have a container with a value fade from 0 to 255. If you split the container in the middle, a key with value 125 is added to new clip borders. Uncheck this option if these keys should not be generated automatically.

- Warn when clip drag would lead to a change of layer type

Since version 5.5 [containers can be dragged](#)<sup>266</sup> from one layer to another. When a container is dragged to a different layer type (that does not share the same parameters as the original layer) its borders turn red and a dialog pops up that warns you about the parameter key loss and needs to be confirmed. If you like to deactivate this additional dialog, untick this check box.



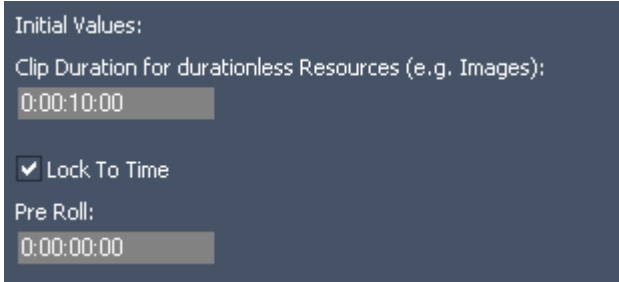

**Clip Initial Values**

- Clip Duration for duration-less Resources  
Images, meshes and other resources do not have a duration like videos. However, if you drag them onto a device in the timeline, they create a container that needs to have a duration. Per default, this container is 10 seconds long. If you like to change this for all new containers, enter a new time. For 5 seconds you can enter "5:00" or

simply "500".

- Lock to Time
- Pre Roll

Enter the properties that should be applied as soon as a new clip / container is added to the timeline. For more information about these and other clip settings see the [Clip Inspector](#)<sup>202</sup>.

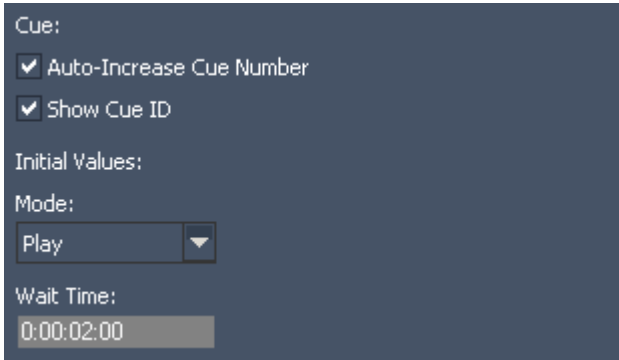

**Cue**

- Auto-Increase Cue Number  
When checked, the Cue Number will automatically increase when the next cue is created. When unchecked, all cues will be created with ID 0 and can be edited later on.

- Show Cue ID  
Per default the ID from a cue is shown in front of its name. If you like to see the name only, untick this check box.

- Initial Values
- Mode

Choose whether a newly created key should be a Play-key or another mode.

- Wait Time

If you generate a Wait-key it has a default Wait time of 2 seconds. If you like to change this for all new Wait-keys, enter a new time. For 5 seconds you can enter "5:00" or simply "500".

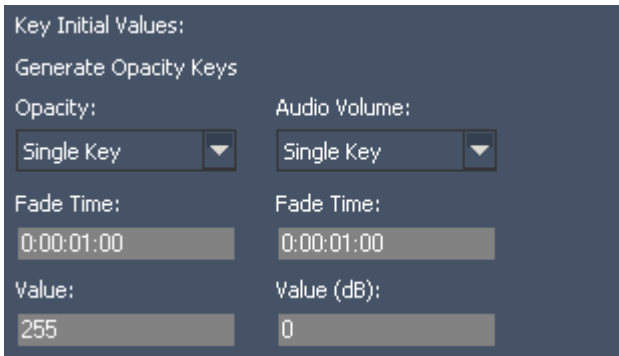

**Key Initial Values**

- Generate Opacity Keys (in new Clips)  
This takes place when a container is created:

- when saving active values
- dragging media files from the Project tab directly in the Sequence
- right-clicking in a parameter track to create a key

Choose with the drop-down menus whether you want to have automatically created Opacity and / or Volume keys in new containers. You can choose to have

- a single key for a constant value
- two keys for a fade in (the maximum value for the fade is either 100% or the active value)
- two keys for a fade out



- four keys for a fade in and out
- no key at all

The Fade Time can be entered in the format H:MM:SS:FF or SFF, e.g. "100" equals 1 second

### 5.2.3.4.4 NETWORK

The section "Network" in the [Configuration tab](#)<sup>139</sup> enables you to set up connection properties applying to the Master-Client-connection.

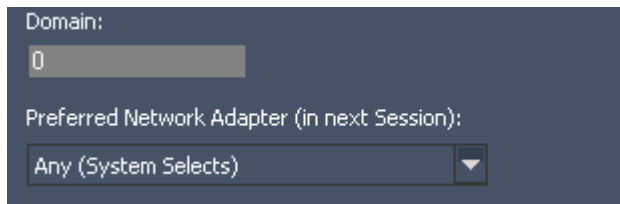

**- Domain**

Please enter here a domain channel number to setup a Master/Client connection.

Please make sure that both, Master and Client, use the same domain channel number in order to be connected to each other.

Valid channel numbers are from 0-65535.

**- Preferred Network Adapter (In Next Session):**

The drop-down menu contains all network cards installed on the system. Select one and restart the application. Now the entire Pandoras Box communication of master and clients will be transferred by this defined adapter and its IP address. This applies for example to show data generated by the video / graphic containers and their keys in the timeline. With choosing a different network adapter for other protocols like Art-Net, you can separate different communication levels from each other.

These protocols can be assigned separately: Pandoras Box show data, [DMX/ Art-Net Mode](#)<sup>146</sup>, [CITP Thumbnail Exchange](#)<sup>146</sup> and [Streaming ACN](#)<sup>153</sup>.

Here, "Art-Net" refers to the data generated when a layer has been patched or if DMX devices are included in the timeline. It does not refer to possible Art-Net data generated by using matrix patches on an [output layer](#)<sup>597</sup> (when working with LED walls and the [Matrix Patcher](#)<sup>757</sup>).

If an explicitly named network adapter is not found, the "any" adapter will be used. "Any" is to be decided by the operating system Windows and its internal adapter order.

### 5.2.3.4.5 REMOTE CONTROL PROTOCOLS

The section "Remote Control Protocols" in the [Configuration tab](#)<sup>139</sup> enables you to set up connections between your Pandoras Box master system and other devices. You may receive and send Art-Net and DMX, exchange thumbnails via CITP or run MANet, Midi Show Control and Streaming ACN.

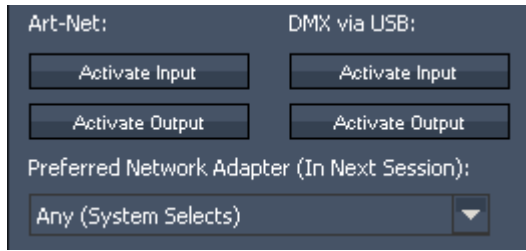

### Art-Net and DMX

- Art-Net:
- Press "Activate Input" to toggle [Art-Net receive mode](#)<sup>621</sup> for remote control of devices or sequences according to the settings in the [Patch tab](#)<sup>222</sup>.
  - Press "Activate Output" to toggle [Art-Net output mode](#)<sup>642</sup> for sending data from DMX devices added to the

sequence.

Since version 5.3 the IP address does not necessarily need to be in the 2.x.x.x range to be able to receive Art-Net. Sending Art-Net is still tied to this specification. If you are working with [matrix patches](#)<sup>757</sup>, you may address a different IP range there, but currently this is not possible for DMX fixtures.

#### DMX via USB:

- Press "Activate Input" if you want to toggle [DMX receive mode](#)<sup>621</sup> via a local [DMX Link In USB interface](#)<sup>735</sup>. This is for remote control of devices or sequences, see also the [Patch tab](#)<sup>222</sup>.
- Press "Activate Output" if you want to toggle [DMX send mode](#)<sup>642</sup> via a local DMX LinkOut USB interface. This is for sending data from DMX devices added to the sequence.

Please note: While Art-Net supports multiple DMX universes simultaneously, a DMX Link USB interface offers only 512 DMX channels that are send on Subnet/Universe 0/0.

#### - Preferred Network Adapter (In Next Session):

The drop-down menu contains all network cards installed on the system. Select one and restart the application. Now the entire Pandoras Box communication regarding the DMX / Art-Net protocol will be transferred by this defined adapter and its IP address. This applies to the DMX / Art-Net data generated when a layer has been patched or if DMX devices are included in the timeline. It does not refer to possible Art-Net data generated by using matrix patches on an [output layer](#)<sup>597</sup> (when working with LED walls and the [Matrix Patcher](#)<sup>757</sup>).

With choosing a different network adapter for other protocols like for the Pandoras Box show data, you can separate different communication levels from each other.

These protocols can be assigned separately: [Pandoras Box show data](#)<sup>146</sup>, DMX / Art-Net Mode, [CITP Thumbnail Exchange](#)<sup>146</sup> and [Streaming ACN](#)<sup>153</sup>.

If an explicitly named network adapter is not found, the "any" adapter will be used. "Any" is to be decided by the operating system Windows and its internal adapter order.

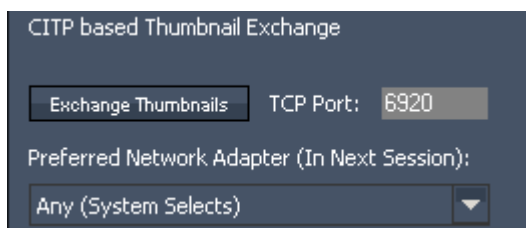

### CITP based Thumbnail Exchange

If you want to exchange Thumbnails with a Chamsys MagicQ console or with the Widget Designer:

- Enter a TCP Port
- Press "Exchange Thumbnails"

Please note: The ChamSys console / Widget Designer have to use the same TCP Port to get a connection.

Pressing "Exchange Thumbnails" again will stop the CITP connection.

#### - Preferred Network Adapter (In Next Session):

The drop-down menu contains all network cards installed on the system. Select one and restart the application. Now the entire Pandoras Box communication regarding the CITP based thumbnail exchange will be transferred by this defined adapter and its IP address. With choosing a different network adapter for other protocols like for the Pandoras Box show data, you can separate different communication levels from each other.

These protocols can be assigned separately: [Pandoras Box show data](#)<sup>146</sup>, [DMX / Art-Net Mode](#)<sup>146</sup>,

CITP Thumbnail Exchange and [Streaming ACN](#)<sup>153</sup>.

If an explicitly named network adapter is not found, the "any" adapter will be used. "Any" is to be decided by the operating system Windows and its internal adapter order.

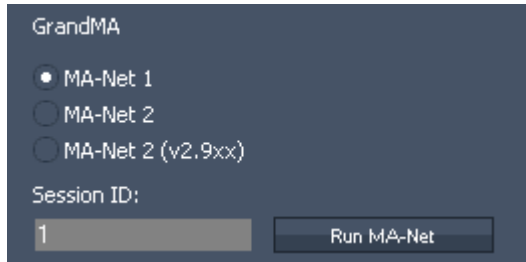

### GrandMA

To interface with GrandMA lighting consoles, please enable the MA-Net:

- Choose the GrandMA Series from the combo boxes.
- Enter the MA-Net Session ID.
- Press "Run MA-Net".

Please note:

MA-Net Series 1 supports up to 64 DMX Universes, MA-Net Series 2 supports up to 256 DMX Universes. They can be patched in the [Patch tab](#)<sup>222</sup>. For more info please read the topic about [DMX Input](#)<sup>621</sup>.

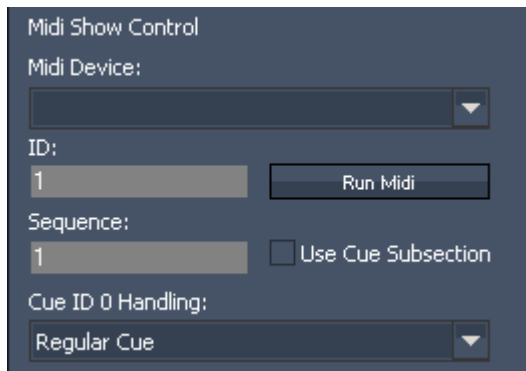

### Midi Show Control

To control a Sequence via Midi Show Control Protocol:

- Midi Device:  
Choose an installed Midi Device from the drop down list
- ID:  
Enter the ID of MSC Message Mapping ( = Device ID - you find it in front of the Servers/Players name in the device tree)

- Sequence:

Enter the ID of the Sequence to be controlled via MSC

- Run Midi:

Press Run Midi to launch MSC and MIDI Input

- "Use Cue Subsection":

As decimal places for cue numbers are not supported in Pandoras Box, you can use the check box option "Use Cue Subsection". Doing this will multiply the incoming cue command x1000 (for example: GO to Cue 1.020 will be interpreted as GO to Cue 1020). With this option three decimal places are supported.

- Cue ID 0 Handling:

Choose between Regular Cue, Ignore, Stop and Stop & Reset all for Cue ID 0 Handling.

The following message types are supported:

Midi: Channel Voice Messages (all Note-On messages are processed)

MSC: System Exclusive messages (SysEx) according to the MSC specification

Please see the following links for detailed information: [Midi](#)<sup>637</sup> / [Midi Show Control](#)<sup>637</sup>.

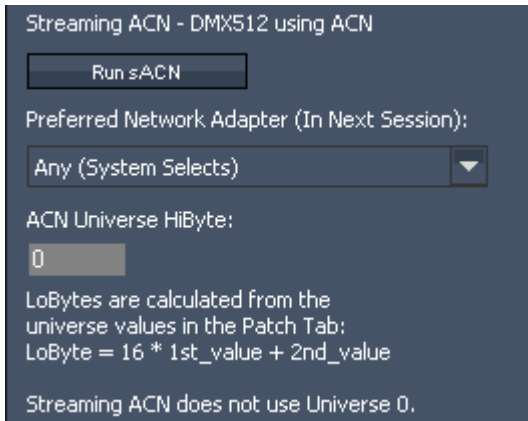

### Streaming ACN

If you want to control Pandoras Box Master via Streaming ACN (sACN), please prepare the [patch](#)<sup>222</sup> as usual. For more info please read the topic about [DMX Input](#)<sup>621</sup>.

To run sACN press [Run sACN].

Please note that Streaming CAN does not use Universe 0, so do not patch below Universe 1.

- Preferred Network Adapter (In Next Session):  
The drop-down menu contains all network cards installed on the system. Select one and restart the application. Now the entire Pandoras Box communication regarding

Streaming ACN will be transferred by this defined adapter and its IP address. With choosing a different network adapter for other protocols like for the Pandoras Box show data, you can separate different communication levels from each other.

These protocols can be assigned separately: [Pandoras Box show data](#)<sup>146</sup>, [DMX / Art-Net Mode](#)<sup>146</sup>, [CITP Thumbnail Exchange](#)<sup>146</sup> and Streaming ACN.

If an explicitly named network adapter is not found, the "any" adapter will be used. "Any" is to be decided by the operating system Windows and its internal adapter order.

### 5.2.3.4.6 STARTUP

The section "Startup" in the [Configuration tab](#)<sup>139</sup> enables you to set up the look and properties when a project is loaded.

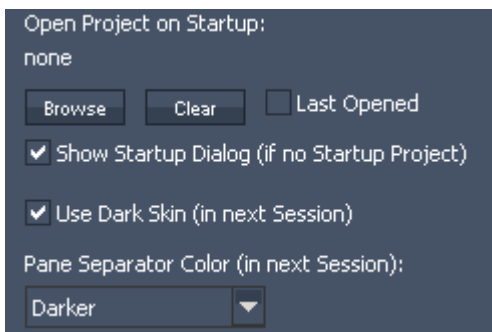

- Open Project on Startup:

Here you can set up the system to load the lastly opened project or a specific project file:

- Press "Browse" to choose a specific project file
- Press "Clear" to reset the load option
- Tick the check box to always open the lastly opened project file

- Show Startup Dialog

This de-/activates the [startup dialog](#)<sup>127</sup> that pops up as soon as Pandoras Box is loaded. There you can choose a

project to be loaded instead of using the [File menu](#)<sup>129</sup>.

- Use Dark Skin

If the check box is activated, the user interface is rendered in the so called Dark Skin. If the check box is not ticked, the interface looks light gray. This option takes effect in the next session.

- Pane Separator Color

You may choose between a darker and a lighter color for the space between two panes. This option takes effect in the next session.

### 5.2.3.4.7 UNIT MANAGEMENT

The section "Unit Management" in the [Configuration tab](#)<sup>139</sup> enables you to set up what units Pandoras Box 3D space is based on. If you are interested in a pixel-oriented workflow, please note, that an according check-box is offered in the Startup Dialog, when you create a new project.

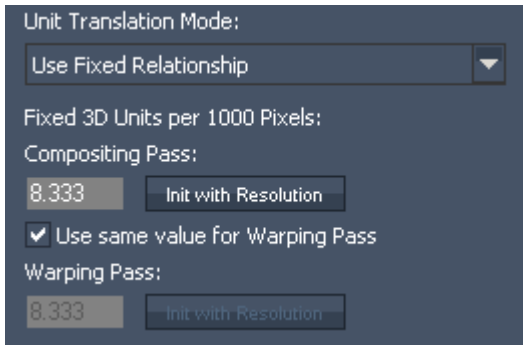

Pandoras Box allows you to work in a 3D space based on so called 3D units or generic units (GU). The result you see on your display is a rendering of the 3D space done in two steps, so called render passes. First a 3D compositing and then a 3D output space is created. The chapter "[V5 Video Processing Pipeline](#)"<sup>297</sup> describes the Composition and Output Pass in more detail. The final render output is based on pixel units. Depending on the resolution set up in the [Display driver](#)<sup>675</sup>, the pixel width and height changes.

Now, there are different options how to translate a 3D unit to a pixel. The default value for the unit translation is "Map 16 3D Units to each Resolution". Pandoras Box sizes the 3D spaces so that 16 3D units exactly match the pixel width of each render pass. This is achieved by applying specific parameters to the camera; the XYZ-position equals 0,0,-25 and the opening angle, the field of view, is 35.489°.

To give you an example, no matter whether your display / render pass resolution is 1024px or 1920px, moving a layer with 8 units has the same result in both displays. If the layer's center was in the middle of the screen, it will now be at the monitor's edge.

In other words, different render passes may map same 3D unit distances to different pixel distances. In the example, 16 units were mapped to the 1024px as well as the 1920px output, hence 8 units is half the width of both monitors.

$$16\text{units} / 1024\text{px} = 0.15625 \text{ units} / \text{px} = 15.625 \text{ units} / 1000 \text{ px}$$

$$16\text{units} / 1920\text{px} = 0.83333 \text{ units} / \text{px} = 8.333 \text{ units} / 1000 \text{ px}$$

When positioning and sizing elements based on pixel values it can be helpful to ensure that the entire system globally uses only one fixed relationship for translating between 3D units and pixels. This is for example of interest when displays with different resolution form one "pixel space", one large screen. Or, when you like to work with pixel values in general e.g. to be able to shift the layer exactly 512px. This form of unit translation can be enabled by selecting 'Use Fixed Relationship' below. In this mode, a distance in pixels always results in the same distance in 3D units independent of render pass resolution.

If you choose to use a fixed relationship, enter how many 3D units should be mapped on 1000 pixel. Per default the Output Pass uses the same translation factor and should be changed only if needed. If your Clients are already connected to the Master system, you may click the "Init with Resolution" button. This opens a dialog that lists all output resolutions from the Clients. Choose one resolution and Pandoras calculates the translation factor automatically. As a result, the cameras of each site will adopt to new default values. Whilst the Z-position stays at -25units, the FOV (field of view) changes to a value according to your translation factor. To ensure consistent translation of units, leaving the cameras in the default state is strongly recommended!

"Origin Settings" are further options that become available when working with a fixed relationship. Layers and other devices (Camera, Output) can be positioned differently in regards to the origin of the coordinate system.

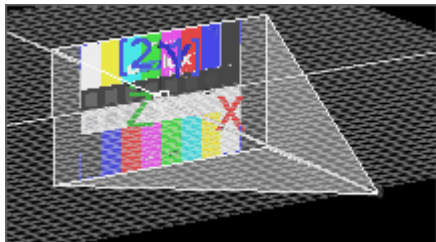

In the left image you see that the layer's and the camera's center match the origin of the coordinate system XYZ=0,0,0.

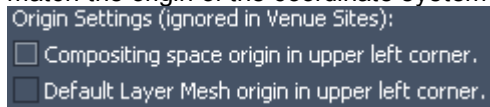

This is the default when the "Unit Translation Mode" is set to "Map 16 3D Units to each Resolution".

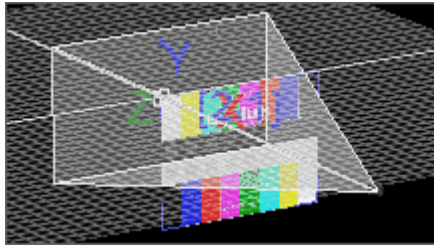

In this example the "Compositing space" is left in the center (check box not ticked) but the "Default Layer Mesh" is activated so that the 0,0,0 origin is in the layer's upper left corner.

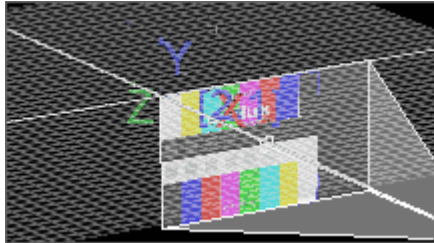
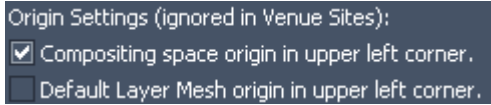

At last, in this example the upper left corner of the "Compositing Space" and the "Default Layer Mesh" match the 0,0,0 origin.

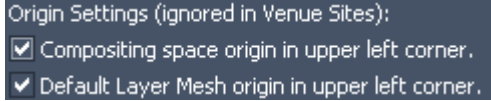

This is the default when the "Unit Translation Mode" is changed to "Use Fixed Relationship". Note that the default values for the camera's XY-position have changed.

If you now like to invert the Y-axis to point downwards, go to [Configuration > Devices / Parameters](#)<sup>139</sup> and tick the according check-box "Invert Y-Axis".



At last, these three buttons ensure that your workflow is based on correct settings.

"Set All Layer Sizing Modes To 'Media Pixel Size' " changes the Sizing Mode from a Layer. Please see further information in the [Layer Inspector](#)<sup>208</sup>.

"Reset All Cameras" resets all (active) parameters from the Camera Layer. As explained above, the translation modes set different default parameters for the cameras. In case you have already changed some parameters, please click this button (and adopt your programming).

"Reset All Layer Z-positions" resets all (active) Z-position parameters from all Video and Graphic Layers. If you work with "Fixed Relationship" and the pixel-oriented workflow the pixel accuracy is only achieved when leaving the layers on Z-position 0.

All these options are already prepared for you in case you open a new project and click the check-box "Pixel-Oriented Workflow" in the Startup Dialog.

### 5.2.3.4.8 PREVIEW DISPLAY

The section "Preview Display" in the [Configuration tab](#)<sup>139</sup> allows to influence how the grid and untextured objects are rendered in the [Preview tab](#)<sup>232</sup> as well as the output of a Client. You can also access the settings through the right-click menu of the Preview tab.

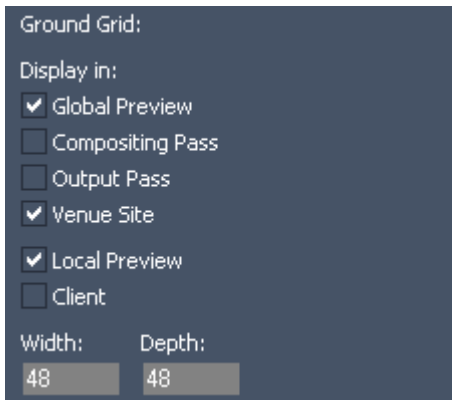

#### Ground Grid

- Display in...

With these check boxes you may choose where you like to see the Ground Grid.

- Width / Height

With the number fields you can influence the size of the Ground Grid.

Default Mesh Shading:

Shade untextured object

Wireframes: Wire Width:  
 Wireframe Edges 0.750

Mesh Colours:

Define Colours:  
 Fill Colour/Alpha: Wire Colour/Alpha:  
 255 255

Use in file defined color  
 Wire Colour Brightness Factor 0.750

Material:  
 Ambient: Diffuse: Specular: Shininess:  
 0.200 0.800 0.600 0.200

Global Point Light:  
 X Pos: Y Pos: Z Pos:  
 0.000 20.000 -10.000

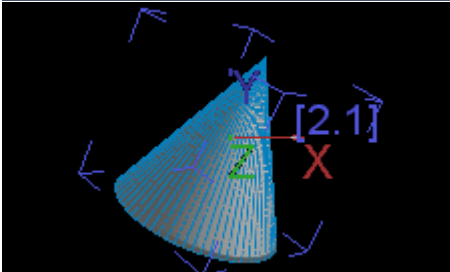

### Mesh Shading and Color

Please note that the [Inspector for an object](#)<sup>195</sup> allows to overwrite the below settings with individual ones. The left bottom example shows an untextured object with gray material color and blue wireframe edges.

-Shade untextured object  
 With an activated option, even objects without an assigned texture are visible as they can be shaded according to the below settings e.g. colored and with visible wireframes.

- Wireframes  
 Choose whether an untextured object should be rendered without Wireframes, with Wireframe Edges or Wireframe Triangles.

- Width  
 Define the thickness of above mentioned Wireframes.

- Mesh Colors  
 Adjust the color of untextured objects.  
 --Define Colors  
 Click on the color fields to define a color that is used for the Fill Color and Wireframes. Use the number fields to adjust the transparency.

--Use in file defined color  
 If the object was originally saved with an assigned fill and wireframe color, Pandoras Box can use them also. Use the number field to adjust the wireframe's brightness.

- Material  
 Adjust the Ambient, Diffuse, Specular reflection levels and the shininess that influence how an untextured object reflects the global light, e.g. to appear rather glossy than dull. [Further information...](#)<sup>484</sup>

- Global Point Light  
 You may adjust the X-, Y- and Z-position of a global light that is reflected from untextured objects according to the "Material" settings.



### 5.2.3.4.9 LOCAL PREVIEW

The section "Local Preview " in the [Configuration tab](#)<sup>139</sup> enables you to set up properties of the local [Preview](#)<sup>232</sup>.

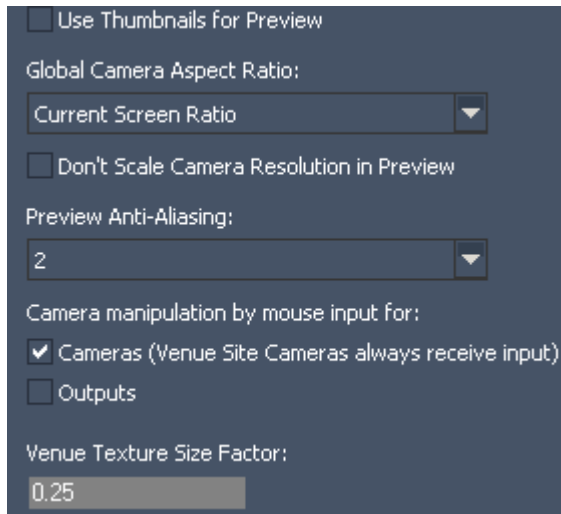

- Use Thumbnails for Preview  
Using this option will show thumbnails instead a full preview of the file. This saves graphic card power on the master system.

- Global Camera Aspect Ratio  
The Aspect Ratio of the Global Camera can be set to one of the options in the pull down list: Current Screen Ratio, 5:4, 4:3, 3:2, 16:10, 5:3, 16:9 or 17:9. This setting refers only to the global cameras wireframe in the preview. If you like to change the aspect ratio from your output, please refer to the [Camera Inspector](#)<sup>214</sup> or [Output Inspector](#)<sup>215</sup>; or change the resolution in your [graphics card driver](#)<sup>675</sup>.

- Don't Scale Camera Resolution in Preview  
This is of interest when working with [Matrix Patches](#)

<sup>757</sup> on a Player or Server as Master. In case you are not rendering fullscreen but in the Preview tab, the Art-Net data would be based on a scaled image. If you need to see correct Art-Net pixels even if the preview is toggled into the user interface, tick the check box. The checked option saves graphics card memory on the Master system. This is especially helpful when previewing many Clients e.g. working with a Venue Site.

- Preview Anti-Aliasing  
The Anti-Alias level for the preview can be set to the value 0, 2 or 4, 4 being the maximum. For memory and performance enhancement the default value is set to 2.

- Camera manipulation by mouse input for Cameras and Outputs  
When the preview displays the "Global" camera, you can use the mouse to navigate it. Using the middle mouse button (wheel): Scroll = Zoom, Drag = Pan, ALT+Drag = Rotate  
If the preview displays a camera from a Site, and the according manipulation check box is ticked, the navigation works as well and results in active values in the Camera Layer, i.e. Target and Viewport parameters.  
Same applies for the output. Per default the navigation is activated for the camera but not the output.

### 5.2.3.4.10 RENDER ENGINE

The section "Render Engine " in the [Configuration tab](#)<sup>139</sup> enables you to set up properties of the local and remote render outputs.

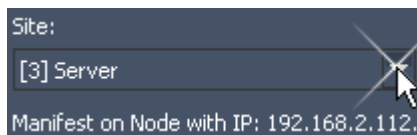

The following settings are site sensitive, please select the according Pandoras Box system with the "Site" drop-down menu. If the node is found in the network the below information will say "Manifest on Node with IP:..." otherwise it says "Node not available in Network".

These settings are also accessible with the button "Open Engine Configuration" in the [Inspector for the site](#)<sup>206</sup>.

### Output hardware configuration

Depending on the [settings in the graphics card](#)<sup>677</sup>, different configurations are possible.

If the driver reports to be in Dual or Extended View, all outputs can be configured individually regarding the ability to go into full screen. This is depicted in the left image. In case one screen should not toggle full screen, check the "Full Screen is single" option and the grayed out check boxes in the column "Use for Full Screen" become available to be activated or deactivated. This is of interest when you like to see the user interface of your master event though you are in full screen mode.

In addition, you can route the physical output adapter (meaning the graphics card output) to an Output Layer. "DISPLAY1" means the primary display, "DISPLAY2" the secondary. This setting is also available in the [Output Inspector](#)<sup>[215]</sup>.

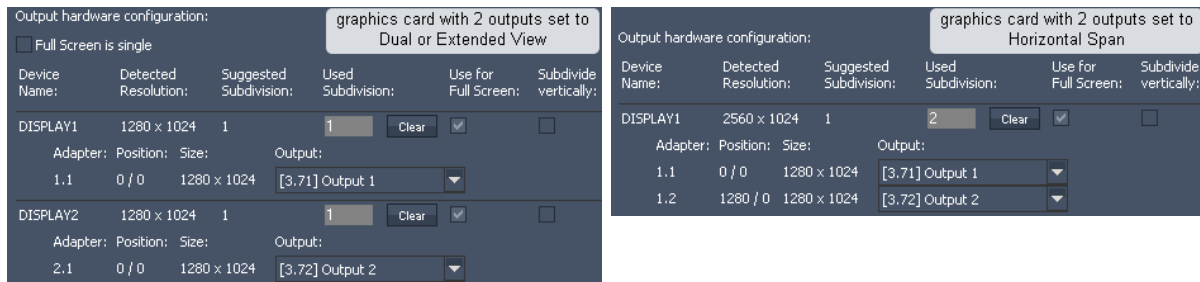

If the driver reports to be in Stretched Desktop (Horizontal Span or Vertical Span) you have two possibilities. First, you can leave the default option, meaning that Pandoras Box subdivides the available output. In case you have two displays devices, the value for "Used Subdivision" is "2" whilst the first one starts at XY-position 0,0 and the second one with an offset of one subdivision width or height. As a next step you can change the routing of physical output adapter (meaning the graphics card output) to an Output Layer. This setting is also available in the [Output Inspector](#)<sup>[215]</sup>.

If you have chosen a setup with a Vertical Span, make sure that the "Subdivide vertically" option is ticked.

The second possibility for both stretched modes is to change the subdivision count to "1". In that case, Pandoras Box handles the entire output as one software adapter. This means that you have one Camera and one Output covering the reported width / height. But as the driver splits the image, you still have an image on all graphic card outputs.

This can be an advantage as you work with less parameters and options. The second Camera and Output have no effect and can be [hidden](#)<sup>[172]</sup> or removed from the timeline. On the other hand this also means that you lose the flexibility of having more parameters. If you like set up one display differently e.g. less opacity, softedge on another side, etc. you need both Output Layers, hence 2 or more subdivisions.

Please note that you cannot take one subdivision out of full screen!

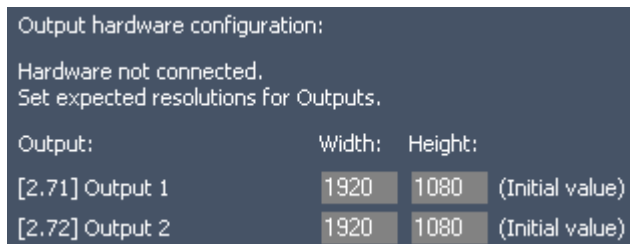

If the Client is not available in the network, e.g. because

- it is not turned on
- it is assigned with no or a wrong IP address
- the PB Client software is not started
- the PB Client software is with a wrong Revision

no hardware configuration can be read from the driver or the operating system. If you like to preprogram your show, you can enter the resolution you will later setup in the Client's graphics card and the Camera and Output will adopt to it. This also influences some ["Layer Sizing Modes"](#)<sup>[208]</sup>. If this resolution change in the real setup, Pandoras Box warns you by displaying a red exclamation mark icon in this Configuration tab. Click on it to see a pop-up showing the user-defined resolution. Check whether this effects your programming and adjust it if needed.



The "Remap" button routes the physical output adapter (meaning the graphics card outputs) in the same order as found displays or subdivision are listed. This is of interest if you have changed the routing and want to go back to the default setting.

## Rendering Performance Settings

Again, these settings depend on the Site chosen in the drop-down list at the top.

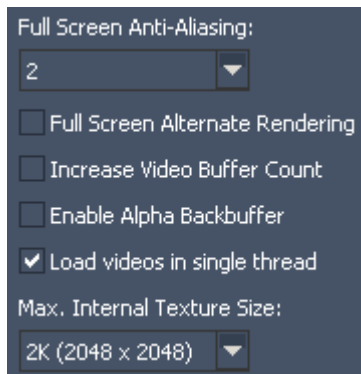

### - Full Screen Anti-Aliasing

This refers to a anti-aliasing method used for smoothing object edges in the last rendering pass. Per default this is the Output Pass, thus the anti-aliasing works on the output mesh. In case you have set the Output's parameter "State" to [Bypass](#)<sup>597</sup>, the anti-aliasing applies to the Compositing Pass meaning objects on layers. The higher the anti-aliasing value, the more memory and performance is drawn but the smoother object edges are rendered (as seen in the below example). The maximum anti-aliasing level depends on the graphics card. For performance enhancement the default value is set to 2.



### - Full Screen Alternate Rendering

Check Alternate Rendering to get a better performance for laptops or older PCs. This setting can influence the fluent playback of videos.

Please note, the settings for Antialias and Alternate Rendering only take effect in full screen mode. In preview mode Antialias will be set to 0 and Alternate Rendering is off.

### - Increase Video Buffer Count

When using [FluidFrame](#)<sup>190</sup> with high-framerate content (50p, 60p files or live inputs), please check the option "High Performance Mode" to ensure smooth playback. In all other cases the High Performance Mode should NOT be used because it requires more system and GPU RAM.

### - Enable Alpha Backbuffer:

Tick this check box if you like to clear the background from the backbuffer texture with alpha. The backbuffer is the result from the output pass. More information regarding Pandoras Box' render passes can be found in the topic "[V5 Video Processing Pipeline](#)<sup>297</sup>". The background RGB(A) color can be set up in the [Output Layer](#)<sup>597</sup> (Server only!)

### - Load videos in single thread

This is of interest when you have programmed multiple containers with video content all starting at the same time. Under circumstances (number of containers, resolution of videos, etc.) this can lead to different render issues as all videos start to be decoded at the same time. With the enabled option the videos start with a millisecond offset enhancing the robustness of the render engine. A drawback is that delay is added. If you need to sync many videos, disable the option and make sure that your programming does not affect the robustness of the render engine.

### - Max. Internal Texture Size

During the rendering process content is buffered onto a so called internal texture. The internal texture is only called when the content is used with

- deinterlacing
- FluidFrame (= frameblending)
- particular effect combination, e.g with Blur

Depending on the resolution of the content you are using with those optional features, you might need to select another entry from the drop-down list. Please note that EVERY content file is then buffered with this size. As this consumes plenty of graphic card memory it is recommended to choose the entry next in size and not simply the largest available.

The drop-down list replaces the 2k or "4K Texture Support" check box known from version below 5.5.

### 5.2.3.4.11 ASIO AUDIO

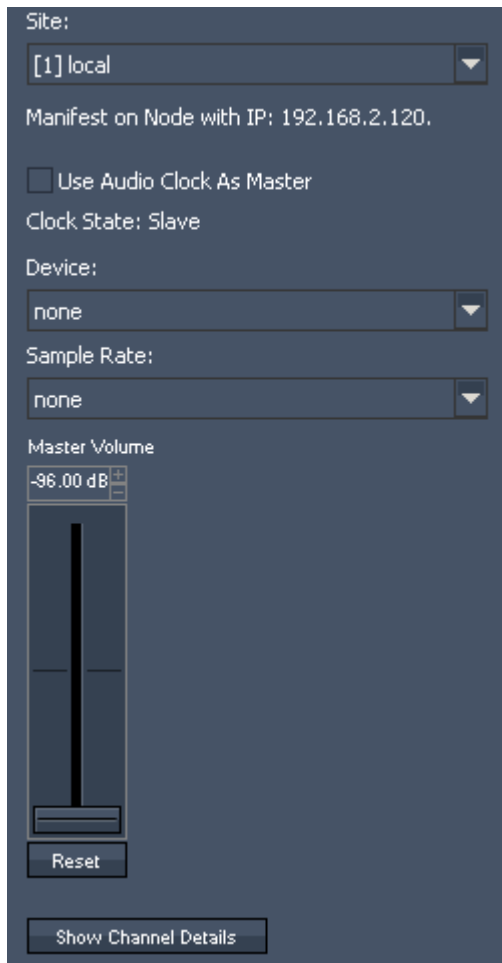

The ASIO Audio section in the [Configuration Tab](#)<sup>139</sup> allows setting up connected ASIO sound card per Pandoras Box system. ASIO sound cards are used by dedicated [Audio tracks](#)<sup>578</sup> in PB Manager software or (since version 5.1) in PB Player / Server running as client or master. Audio tracks allow playing back ASIO wav files while being synchronized to a master clock.

#### Video to audio synchronization

Choose with the "Site" drop-down menu a Pandoras Box system, and assign an available ASIO device with the "Device" drop-down. Decide by ticking the check box "Use Audio Clock as Master" whether this system should send the master clock. Please note, that there can be only ONE master in the system! The ASIO clock will be the system's master clock and all video layers on all clients within the entire PB network will be synched to it.

It is possible to output ASIO on multiple systems but it is not possible to synchronize the audio on more than one system while playing back. If you output ASIO on another system (than the one that generates the master clock), THEIR audio tracks cannot be synched while playing back. They will be triggered in synch but as soon they are running they are in a free-run mode.

#### Timecode master – not timecode slave

The ASIO clock will be the system's Timecode master. It is not possible to have two master clocks in a system; ASIO

and SMPTE can't be used simultaneously.

#### Sample accurate audio and master volume

Choose a sample rate from the "Sample Rate" drop-down list (41 kHz, 44.1, 48 kHz, 96 kHz as supported by the sound card). All sound files within the project should be created as wave files with the same sample rate.

Please note that the ASIO Tracks will play mono and stereo PCM Wave files (16 or 24 bit). The Audio Tracks will play mono and stereo PCM Wave files (16 or 24 bit) with the sample rate that is preset in the Audio Configuration only, there will be no sample rate conversions done: each sample will played back 1:1.

There are test files with various sample rates and volumes in the Stock Assets folder.

The fader sets the master volume of your ASIO sound card. Value Range: -96 dB (muted) up to 6 dB (max.). Default value is -9 dB.

#### Multi-channel ASIO output

The ASIO protocol allows multichannel audio output, depending on the sound card up to 64 audio channels are supported. In order to assign a track to a specific audio channel of your ASIO sound card, please refer to the [Track Inspector](#)<sup>213</sup>.

Show Channel Details:

This list reads the sound cards settings and gives you an overview how the channels are routed in the sound card.

### 5.2.3.4.12 EXTENSIONS

The section "Extensions" in the [Configuration tab](#)<sup>139</sup> allows to set up additional extensions.



To interact with WYSIWYG CE coolux console edition, enable this option first by pressing [Enable] and then start your WYSIWYG console edition.

### 5.2.3.4.13 SMPTE TIME CODE

The section "SMPTE Time Code" in the [Configuration tab](#)<sup>139</sup> allows to set up timecode options for an attached [SMPTE Link interface](#)<sup>735</sup>.

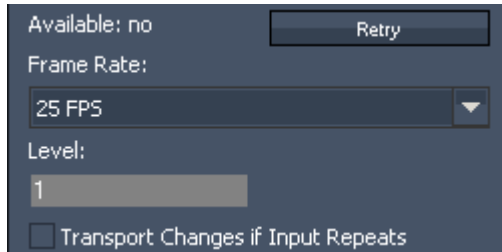

If you want to use a SMPTE Link interface for either SMPTE send or receive mode, please connect the SMPTE Link USB device, the availability will then switch to "YES". If not, Pandoras Box cannot find the SMPTE Link. Try to reconnect it to the hardware, restart Pandoras Box or re-install the driver found in the [coolux Download Center](#) our web site. To set a timeline to "Send" or "Receive" please see the [Sequence Inspector](#)<sup>200</sup>.

- Retry:

Use the "Retry" button if you have lost communication or the SMPTE Link was removed from the USB port.

- Frame Rate:

Setup the frame rate that you want to use for either send or receive mode of the SMPTE Link interface.

- Level:

The level setting is important for send mode only. You may enter values between 0 and 1 to amplify the SMPTE output signal level.

- Transport Changes if Input Repeats

Some SMPTE sending devices continue sending the last frame instead of stopping the SMPTE transmission.

If this option is not enabled, and the SMPTE devices sends 3x an identical frame, the timeline will continue running until it receives a different frame.

If this option is enabled, the timeline will execute the Stop-Action set up for this sequence.

### 5.2.3.4.14 WEB SERVER

The section "Web Browser" in the [Configuration tab](#)<sup>139</sup> allows to set up the integrated web server in Pandoras Box.

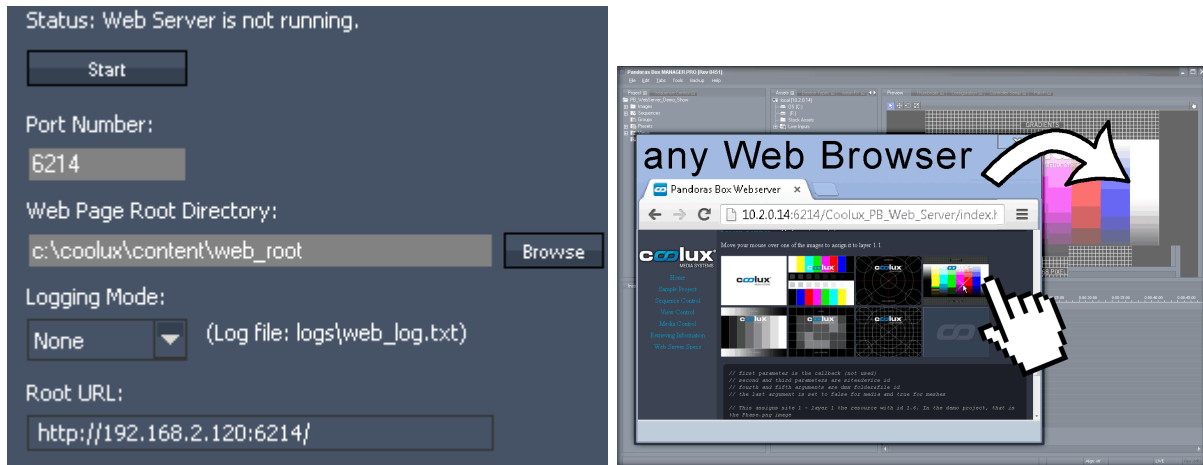

### The principle of Pandoras Box' Web Server

Version 5.5 comes with the newly developed Pandoras Box Web Server. It offers remote control of a Pandoras Box project that can be implemented into a web site. All PB Automation commands, known from the [SDK](#)<sup>1532</sup>, are now executable in JavaScript language, and thus can be embedded in the HTML code by your web developer.

There is a demo web site that shows what can be done and how the PBAutomation commands are implemented in the web site's code. If you like to view it, open a Pandoras Box master system and activate the web server. Then go to your browser and enter your IP address and the port number, e.g. `http://2.0.0.100:6214` (alternatively you may copy-paste the URL from the Configuration tab) to - this calls the web server and shows the delivered web site. This site contains a link to the demo site which is installed per default in the web root folder under `c:/coolux/content`. If you like to write your own site please make sure to place it in this web page root directory.

Please note that the internal Pandoras Box Web Server can be used without access to the internet, it is meant to be used in (secure) local networks. For bigger installations it might be of interest that external web servers can be used in combination with the PB web server. For example, an Apache HTTP Server can be used or any other web server that supports the scripting language php. This server is then used to deliver the web sites to the browser and forward commands to or receive information from the PB web server. This setup has advantages for larger installations and for those that need access to the internet (as the PB server can be invisible), or for database applications.

### Settings in the Configuration tab

Click the Start button to activate the web server which acts then as an interface. You may send commands to the web server, it "translates" them and forwards them to Pandoras Box; in return Pandoras Box sends requested information through the Web Server to you.

Per default the port number used by the web server is 6214, it can be changed if needed. As well the directory and URL for the web page root can be altered. There is a log file that logs when a command was send or received, an error or another action happened. The log entries can be filtered; choose your logging mode (None, Limited or Full) in the drop-down list.

### 5.2.3.4.15 CACHE

The section "Cache" in the [Configuration tab](#)<sup>139</sup> allows to clear the internal cache in Pandoras Box.

Thumbnails are used in various places in Pandoras Box:

- the Thumbnails tab
- the Inspector when a media file in the Project is selected
- as a small thumbnail in a container in the Sequence tab
- in the Preview if "Use Thumbnails for Preview" (Configuration tab > [Local Preview](#)<sup>153</sup>)

For every file in the Project tab, Pandoras Box generates an according thumbnail and saves it in the project folder\local\_cache\_thumbs.

 In case that you encounter any issues with loading images or thumbnails, you may press "Clear Thumbnail Cache" which deletes all files in the "thumbs" folder , and the next time you start the project, the thumbnail and image files will be rebuilt.

### 5.2.3.5 CONTROLLER SETUP

In the Controller Setup Tab the assignment of Sequence Faders and Cue Button controls for the coolux Jog Shuttle and the coolux Fader Controller will be done. Without assigning these Faders / Buttons the controller boards won't work.

#### HAVING A JOG SHUTTLE CONTROLLER CONNECTED

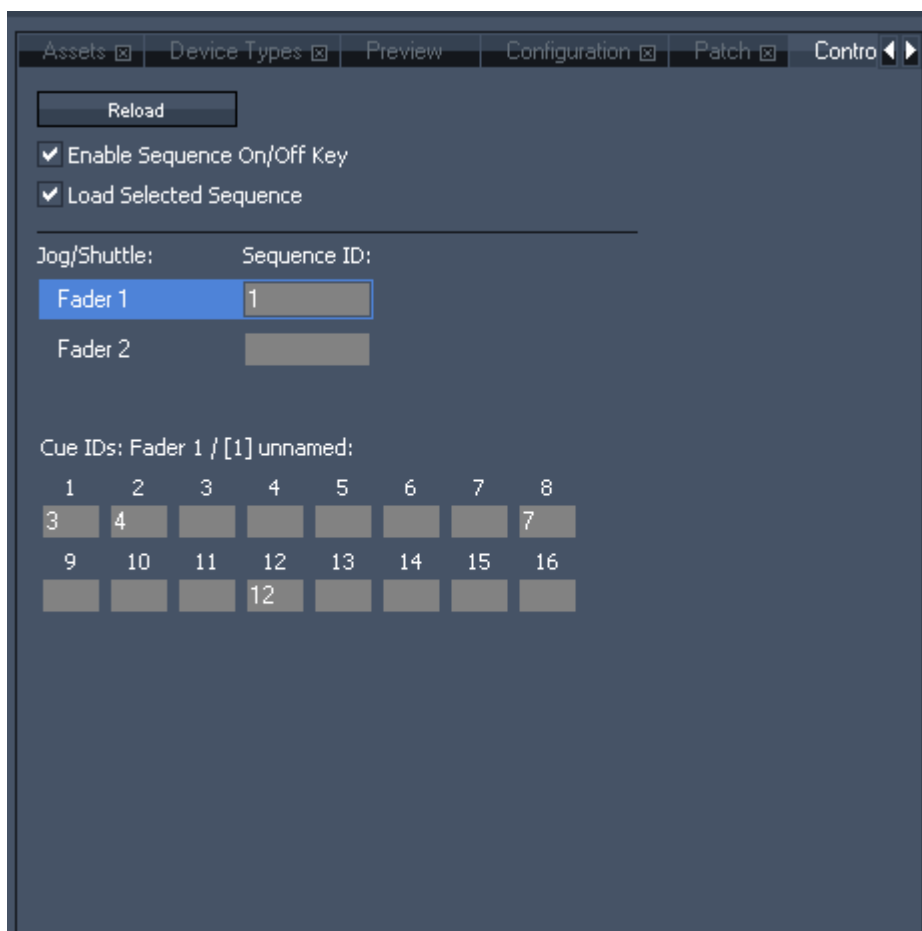

---

The image above shows the Controller Tab with the [Jog Shuttle Controller Board](#)<sup>709</sup> connected to the Pandoras Box Master device.

[Reload]:

Press this button if the connected Controller Board is not shown in the tab. This will reload the connection.

[Enable Sequence On/Off Key]:

This option is valid for the [former Jog Shuttle Controllers](#)<sup>711</sup>. The Sequence On/Off Key is enabled by default. This button will toggle the opacity of the selected sequence between 0% and 100%. This option may be disabled so that the sequence can't be turned off by fault.

[Load Selected Sequence]:

When this option is enabled, the sequence selected by the sequence faders will be active and loaded into the [Sequence Tab](#)<sup>260</sup>.

[Jog Shuttle]:

The Jog Shuttle Board allows controlling two sequences. To assign a sequence in Pandoras Box to a Sequence Fader and Select Button on the Jog Shuttle Board, please enter the sequence ID into the text field next to Fader 1 or Fader 2.

[Cue IDs]:

For each sequence that is linked to the faders 16 specific cues may be called via the Cue Buttons.

To assign the Cue Buttons to specific CueIDs in Pandoras Box:

- Select the Sequence whose cues you want to link to the Cue Buttons by clicking on Fader 1 or Fader 2 in the Jog Shuttle section.
- The title of the Cue IDs changes to the Fader number and the Sequence ID linked to this fader.
- Enter a Cue ID for a Cue Button.

HAVING A FADER CONTROLLER CONNECTED



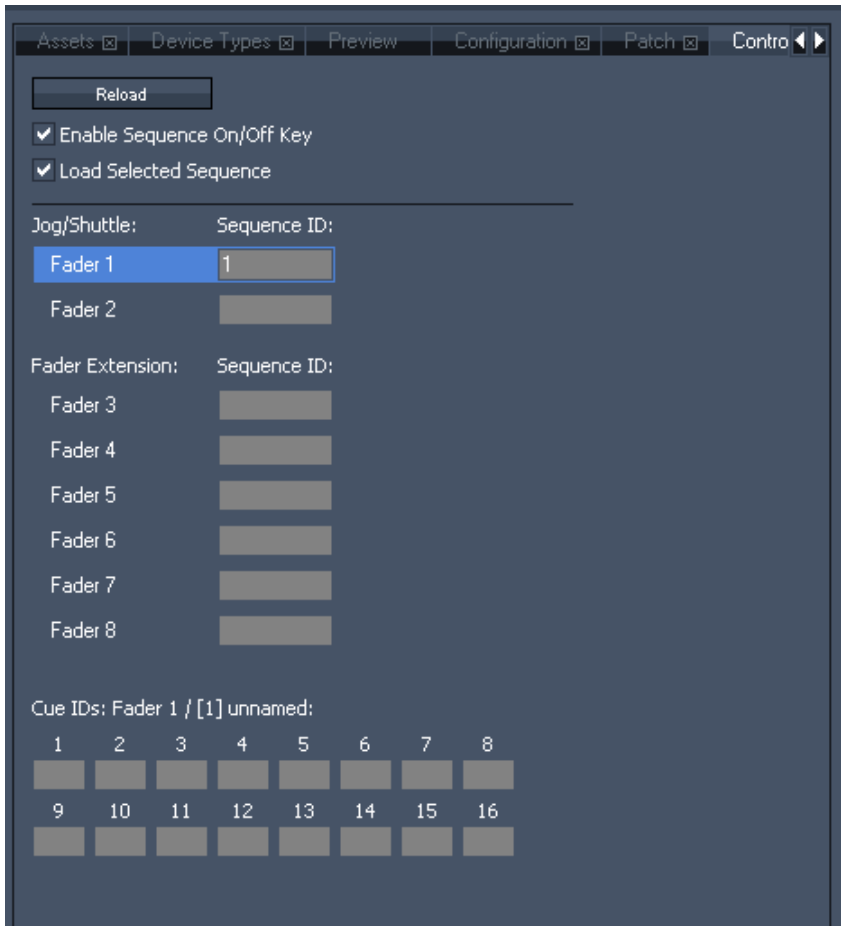

If there is a [Fader Extension Board](#)<sup>710</sup> attached to the Pandoras Box Master Device as well, the Controller Setup Tab shows 6 additional faders.

Assign sequences in Pandoras Box to these additional faders the same way you do when working with a Jog Shuttle Board. For each of these sequences 16 specific cues may be called via the Cue Buttons on the Jog Shuttle Controller as well. For information about how to assign these CueIDs, please see "CueIDs" above.

**5.2.3.6 CURVE EDITOR**

To open the Curve Editor Tab, please click on 'Tabs' in the Toolbar - Curve Editor.

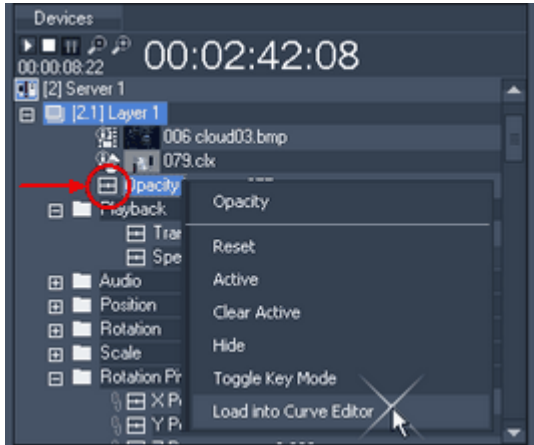

For changing the curve of a parameter, make a right-click on this parameter in the device tree and choose "Load into Curve Editor".

You can also double-click on the Curve Editor icon in front of the parameter's name in the device tree.

Please note that you need a sequence in order to edit curves.

In the example, the opacity of Device [2.1] is loaded into the curve editor.

Underneath the tabs you see the timeline and the current position of the now pointer. The first time you open the Curve Editor it opens with time 0:00:00:00, press play (or

hit the space bar) to jump to the time the now pointer is located in the sequence tab. From now on as soon as you position the now pointer differently in the sequence tab, the frame in the Curve Editor will follow automatically and vice versa.

As well container and keys are synchronized.

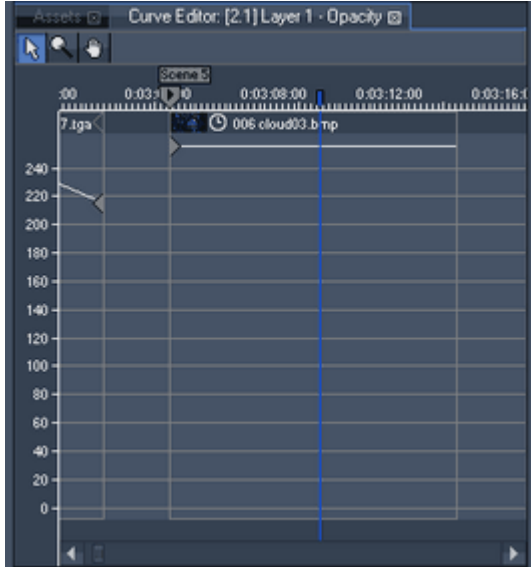

Below the timeline there is the clip container including a thumbnail and the name of the clip. The greyish borders on the left and right mark the start and end time of the clip container. The greyish borders on the top and bottom mark the value range of the parameter (depending on 8 or 16 bit values).

In this example the opacity key at the left border shows a constant value going until the end of the clip.

To navigate in the Curve Editor there are three modes:

- select and edit clips, key frames and their handles
- zoom the y-axis (the parameter value range) that is depicted on the left diagram border. Pressing ALT will zoom out. Alternatively you may use the shortcuts SHIFT and + / - on your main keyboard.

To zoom the x-axis (the time) use + / - , just as you do it in the sequence.

- move the content depicted in the Tab in both axes (without moving the now pointer). Alternatively hold down the M key on your keyboard.

#### INSERTING / REMOVING KEYS

To insert more keys for the used parameter, right-click in the Curve Editor and a new key will be created.

To remove a key, select it and press DEL on the keyboard.

#### EDITING KEYS

To move a key, please drag and drop it to the new position.

Moving it left and right will move it within time.

By moving it up and down, the value of the key increases or decreases.

With the shortcut CTRL and the left / right arrow keys you snap the now pointer exactly to key frame. Now, when dragging the key frame up and down it will stick to the same time.

If you want to move it to a certain value, do a right-click on the key and insert the value or click inside the value field and move the mouse-cursor up and down.

Alternatively you may use the Device Control Tab or the Inspector Tab. But only the Inspector gives the possibility to multi-select item and change them synchronously.

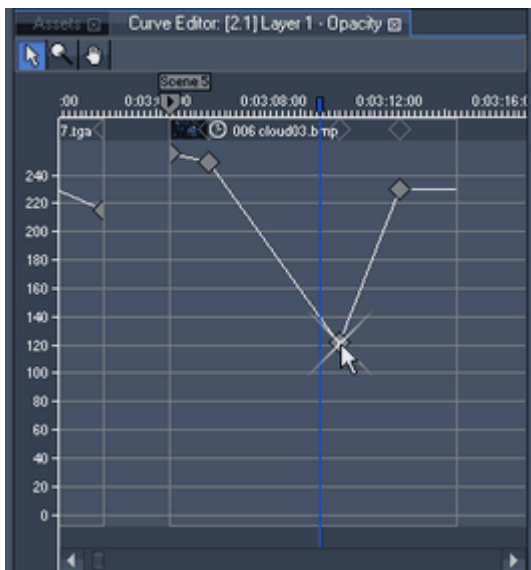

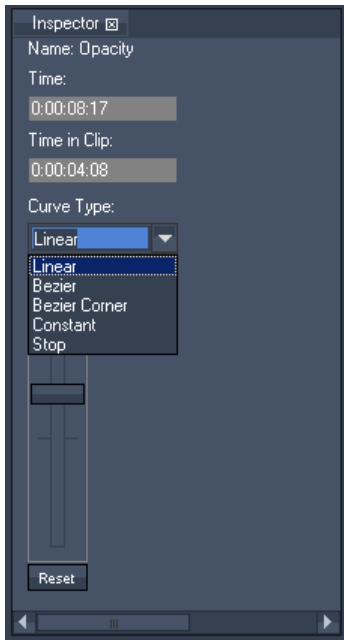

### CURVE TYPES

To change the curve type of a key, select the key and choose a Curve Type from the drop down menu in the Inspector Tab.

You can choose between Linear (Standard), Bezier, Bezier Corner, Constant and Stop.

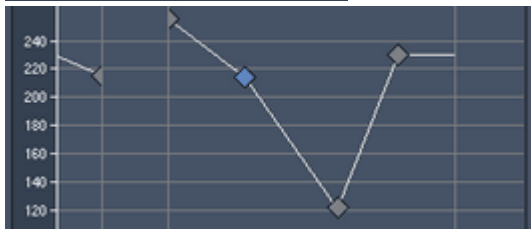

- Linear  
 A linear line is drawn between the previous and next key.

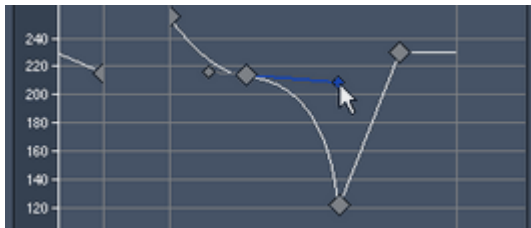

- Bezier  
 The key gets two handles and you can intuitively smoothen the curve by moving the handles and changing their length. The handles always will stay in a line.

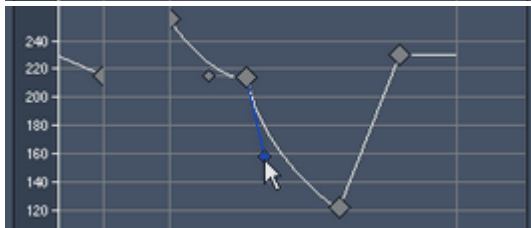

- Bezier Corner  
 Compared to Bezier the handles can be modified independently from each other.

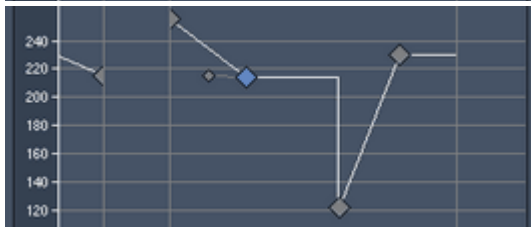

- Constant  
 The value of the key will be continued until a new value is given.

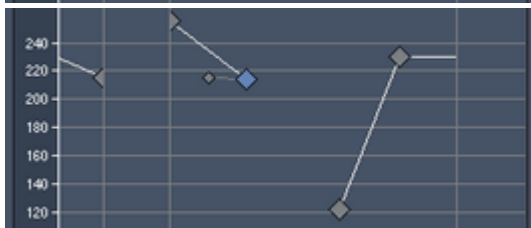

- Stop  
 The connection to the next key will be removed, the key's value will be held until a new value is given.

### 5.2.3.7 DEVICE CONTROL

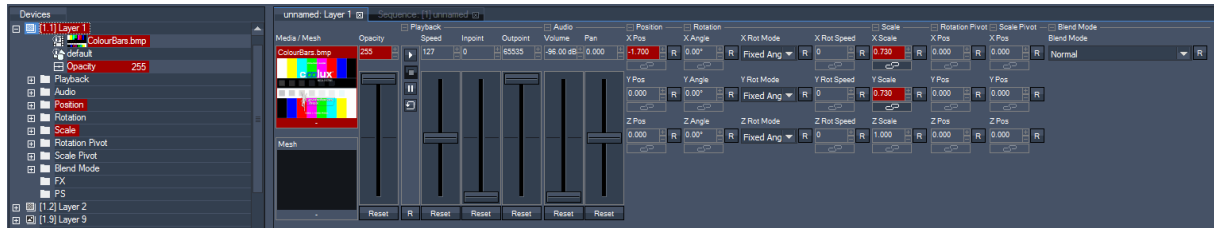

Figure: The Device Control Tab, having Layer 1.1 loaded.

Depending on the device selection from the device tree in the [Device tab](#)<sup>168</sup>, the device parameters will be loaded into the Device Control tab.

A selected device in the device tree will have its node icon highlighted in blue.

See the following chapters for information about the handling of the Device Control tab:

[Parameter Value Readout](#)<sup>164</sup>

[Parameter Value Ranges](#)<sup>164</sup>

[Changing Parameter Values](#)<sup>165</sup>

[Linking Parameters](#)<sup>165</sup>

[Expand & Collapse Parameter Sections](#)<sup>167</sup>

If you are interested in detailed information about all available layer types and parameters, please refer to the topic "[Device Control](#)<sup>164</sup>", e.g. including a chapter only describing the controls within a [Video Layer on Pandoras Box Servers](#)<sup>298</sup>.

#### 5.2.3.7.1 PARAMETER VALUE READOUT

The parameter values are shown in decimal readout and centered by default.

To display them in percentage readout and/or non-centered, please have a look in the [Configuration tab > Devices / Parameters](#)<sup>139</sup>.

#### 5.2.3.7.2 PARAMETER VALUE RANGES

Depending on the parameter type the values cover different value ranges.

For example the opacity parameter can be set from 0 up to 255, the rotation parameters can be set from -9999.99° up to +9999.99°.

When controlling the Pandoras Box Master via DMX, MA-Net, Art-Net or sACN there is only a limited value range useable for the most parameters. This is due to the 8 bit / 16 bit channels of DMX control.

For example the opacity parameter value range can be used completely (0-255 = covered by one 8bit DMX channel). But the rotation parameter values range only from -1080° up to 1080° (instead from -9999.99° up to +9999.99°). This value range is divided into 65535 DMX steps (one 16Bit DMX channel), so that 1 DMX step corresponds 0.033°. Please see the [DMX tables](#)<sup>623</sup> and the [Device Control](#)<sup>296</sup> Section for detailed information about each parameter of the different device types.

### 5.2.3.7.3 CHANGING PARAMETER VALUES

All changes made to the parameter values will turn the parameter active and red.



If there is a fader for the parameter, you have the following possibilities to change the parameters value:

- Use the fader handle for coarse control
  - Click the fader once and use the arrow keys (up/down) = +1 / -1 value; Holding [CTRL] while using the arrow keys (up/down) = +10 / -10 values.
  - Click in the numeric value field above the fader, hold the mouse button clicked and move the mouse up / down for sharp tuning.
  - Click + / - next to the numeric value field for finest control.
  - Enter the new value manually into the numeric value field and press [ENTER] to apply the change.
- Press [Reset] to set the parameter back to its default value. The status “active” will be removed from the parameter.

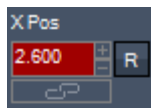

If there is only a numeric value field for the parameter, you have the following possibilities to change the parameters value:

- Click in the numeric value field, hold the mouse button clicked and move the mouse up / down for sharp tuning.
- Click + / - next to the numeric value field for finest control.
- Enter the new value manually into the numeric value field and press [ENTER] to apply the change.
- Press [Reset] to set the parameter back to its default value. The status “active” will be removed from the parameter.

### 5.2.3.7.4 LINKING PARAMETERS

To link several parameters click on the link icons above the faders or numeric text fields in the device control tab or left to the listed parameters in the device tree. If one of the parameters is changed now, all parameters linked will accept the values in relation to it.

Please note:

Only parameters from the same type (like rotation or scaling) can be linked!

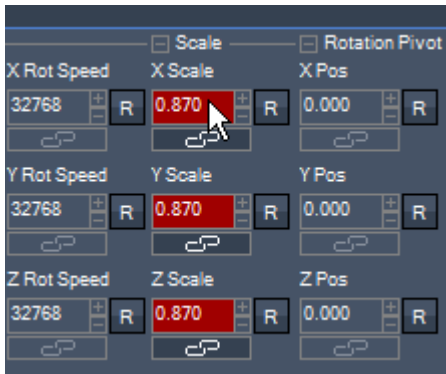

Figure 1: X-, Y- and Z Scale parameters are linked in the device control tab; changes on X Scale apply to Y- and Z Scale as well.

### 5.2.3.7.5 EXPAND & COLLAPSE PARAMETER SECTIONS

To have a better overview in the Device Control Tab, parameter sections may be shown in collapsed or expanded mode.

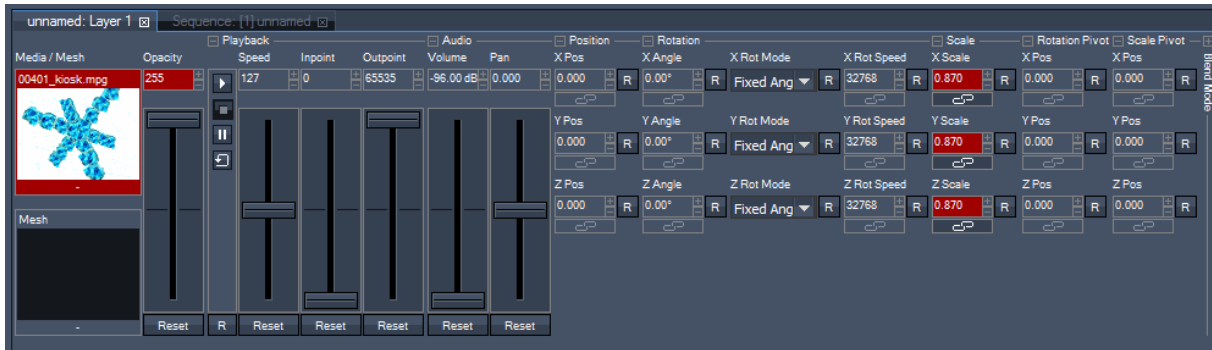

Figure1: nearly all parameter sections are expanded.

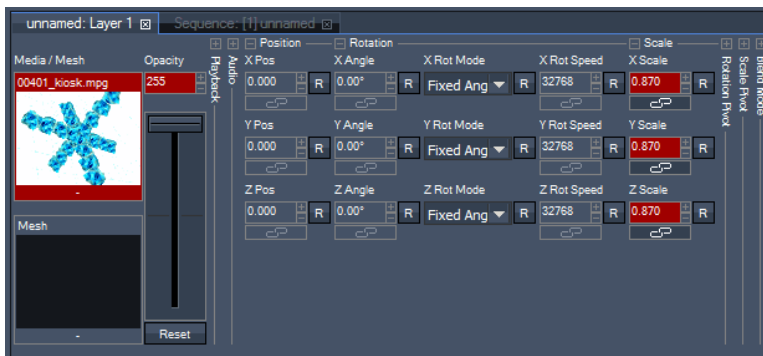

Figure2: the parameter sections that are currently not relevant for the programming are collapsed.

To collapse a parameter section:

- Click the “-“ icon in front of a parameter section name
- Double-click the parameter section name or its following line
- Double-click in the area below the parameters
- Use the right-click menu

Expand a parameter section:

- Click the “+“ icon above the parameter section name
- Double-click the line following the parameter section name
- Double-click in the area below the parameters
- Use the right-click menu

Right-click menu:

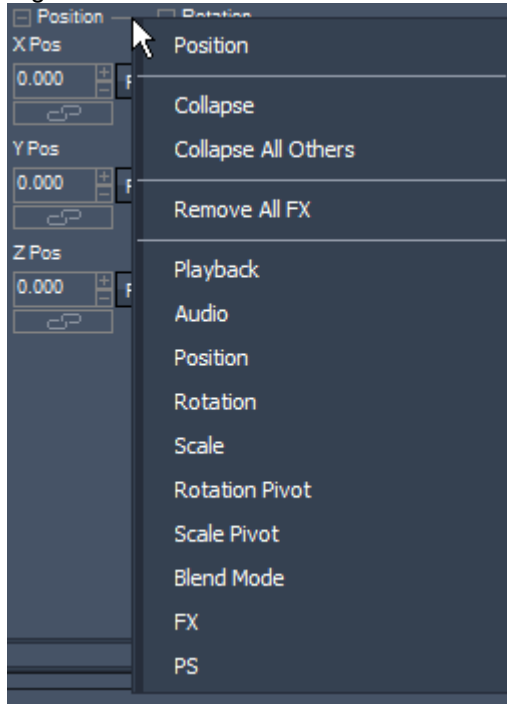

The right-click menu (right-click in the height of the parameter section names) allows to:

- Collapse / Expand the current parameter section
- Collapse all other parameter section except this one
- [Remove All FX](#)<sup>328</sup> from the device
- Expand any parameter section by name.

### 5.2.3.8 DEVICE TREE

The device tree is the main place to browse and edit all available devices in the project.

If you are working with a Pandoras Box Player or Server system in stand-alone mode the "local" lists all layers that are part of your system. If you are not working in stand-alone mode but with a master and client system(s) you need to add these clients (including their layers) to the Device Tree as well. If the clients are already connected, i.e.:

- started (in the same Revision as the master system) and showing the [Pandoras Box client window](#)<sup>294</sup> and
  - set to the correct IP address and Pandoras Box domain
- you may see them in the [Assets tab](#)<sup>137</sup> and add them from there to the Devices tab (shown in the right image below). If this is not the case, e.g. if you like to pre-program a show, you may drag an according system from the [Device Types tab](#)<sup>181</sup> into the device tree. Later on, when the real systems are connected, you can simply select the pre-programmed client and enter the IP address in the [Device Inspector](#)<sup>206</sup>.



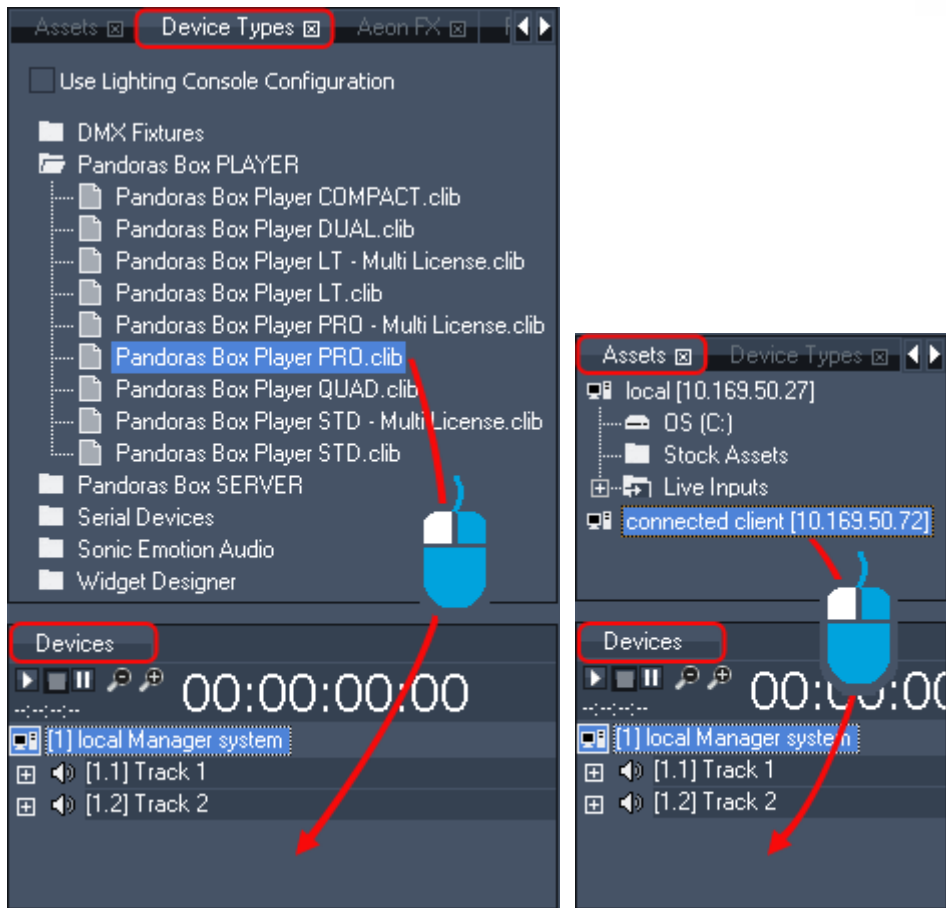

After adding a system to the Devices tab, it is shown with collapsed layers. To unfold/fold a site or device tree double-click on it.

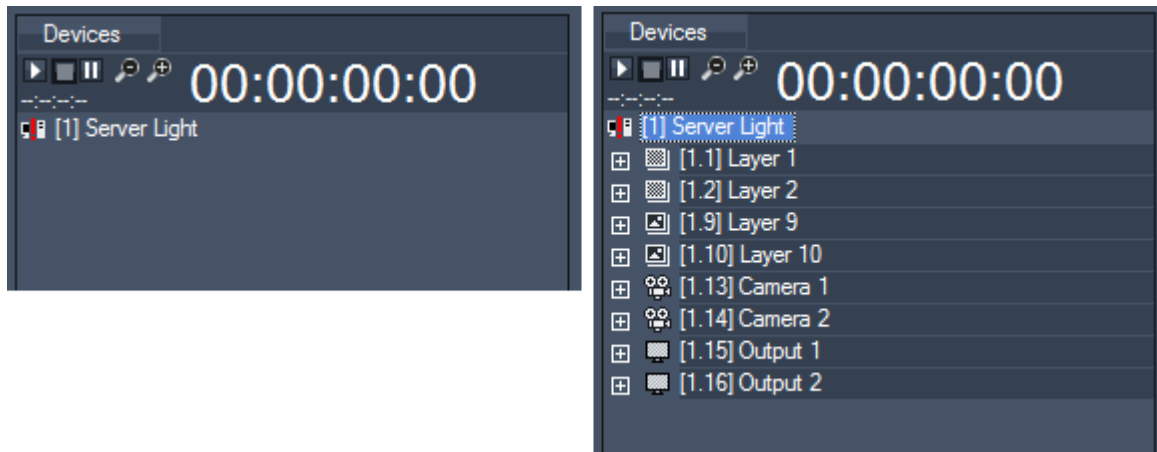

Figure left: The Site named “Server Light” is collapsed. Figure right: After a double-click on the Site icon the standard amount of devices is shown.

The Device Tree...

- Is always linked to the Sequence Tab in order to browse and edit keys stored to the sequence
- Allows you to sort the layer and FX structure
- Allows to show / hide parameters, layers, sites
- Allows a site to be included in / excluded from the preview.

The Device Tree section is separated into the following themes:

- [Build-Up](#)<sup>170</sup>
- [Context Menus](#)<sup>172</sup>
- [Device Selection](#)<sup>176</sup>
- [Structured View](#)<sup>178</sup>

If you are rather interested in the devices itself, e.g what is the meaning of a parameter in a Video Layer, how to add an effect to a layer or how to use a DMX device (DMX fixture) please refer to the topic about "[Device Control](#)<sup>296</sup>".

### 5.2.3.8.1 BUILD-UP

This topic explains how to change the view in the Device Tree tab itself and how to change the render order of layers.

#### Device structure and different layers

When adding a site (from the [Assets tab](#)<sup>137</sup> or [Device Types tab](#)<sup>181</sup>) to the Device Tree it does not show the included layers. The site looks like the one in the left image.

Once a site is unfolded (by double-clicking on the site) the default device structure is shown, see the middle image. The default view includes for example the first two graphic, video and audio layers as well as all available cameras and outputs. The number of layers shown per default, can be changed in the [Configuration tab](#)<sup>139</sup> > General Settings.

You may unhide layers or add new ones. The right image shows the Server with an added Pointer and Light layer. The commands can be found when right-clicking on the site itself; as explained in the next topic "[Context Menus](#)<sup>172</sup>".

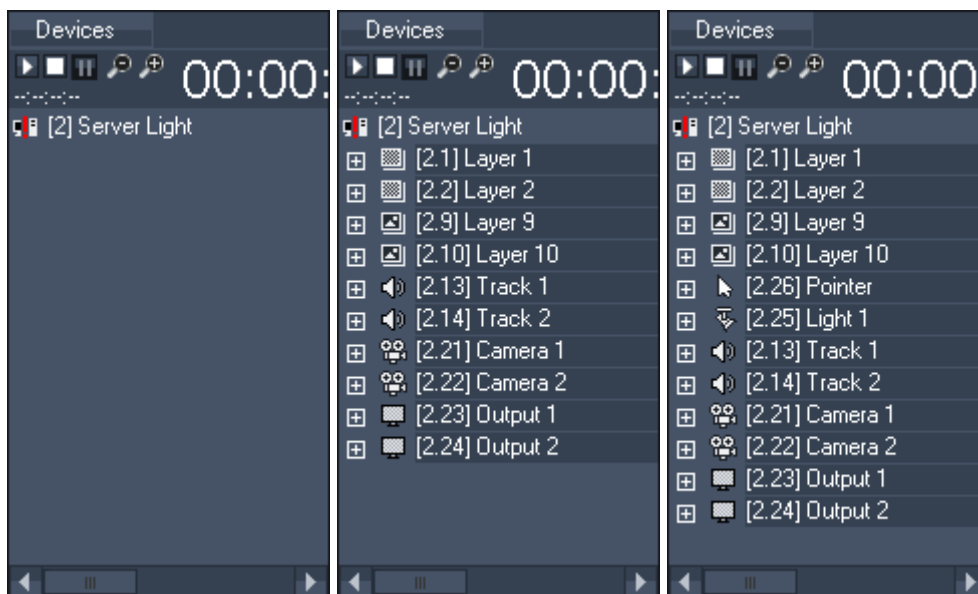

How many and what type of layers you may add, depends on your PB device. See the topic [Product Overview](#)<sup>65</sup> for more details. See here the list of the different layer/device types:

	Manager	Player	Server
<a href="#">Video Layer</a> <sup>298</sup>	-	yes	yes
<a href="#">Graphic Layer</a> <sup>577</sup>	yes	yes	yes
<a href="#">Pointer</a> <sup>581</sup>	yes	yes	yes
<a href="#">Light</a> <sup>582</sup>	-	-	yes
<a href="#">Audio Track</a> <sup>578</sup>	yes	yes	yes
<a href="#">Camera</a> <sup>589</sup>	-	yes	yes
<a href="#">Output</a> <sup>597</sup>	-	yes	yes

### Changing the render order of layers

All Video and Graphic Layers are arranged close to each other in Z order: Layer 1 is the bottommost layer, all other layers enqueue above this layer 1.

The device tree allows you to change this layer order (without having any Z Position changes applied to any layer). Simply unfold the site and drag and drop any layer to another position.

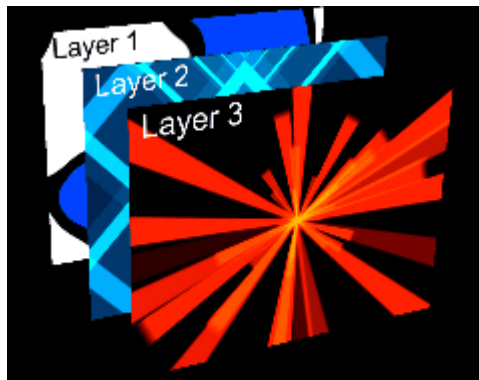
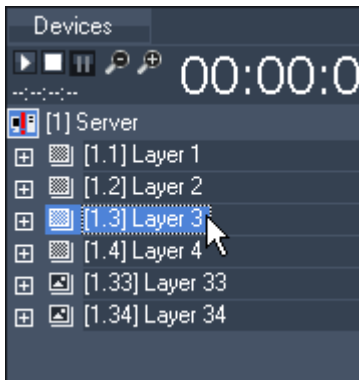

The two images above show the default layer order.

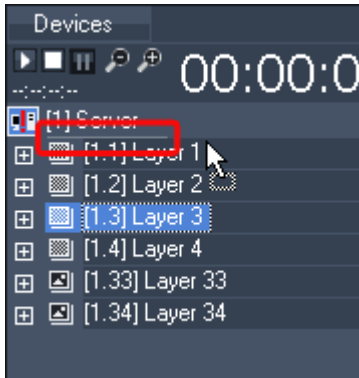

Then, layer 3 is selected and dragged above layer 1. Note that the mouse cursor changes and that the new position of the selected layer is indicated by a slender white line (enhanced with a red rectangle in the left image).

After dropping layer 3 it now sits above layer 1 in the device tree. The result is that layer 3 will be positioned behind layer 1 now in Z order and the preview looks like in the image below.

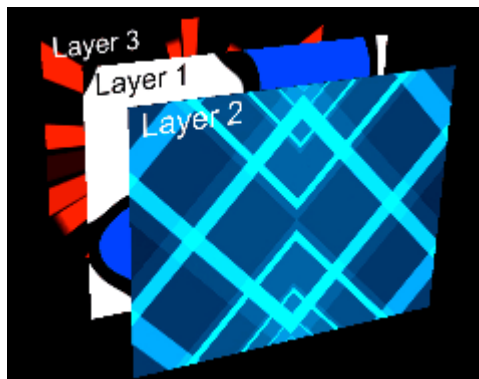
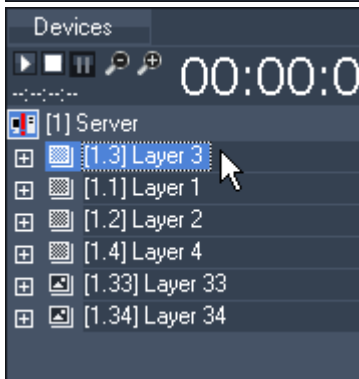

### 5.2.3.8.2 CONTEXT MENUS

Several context-menus are available to filter the view of the device tree. This topic explains the context menus from a site, a [device](#)<sup>173</sup> and a [parameter](#)<sup>174</sup>.

#### The context menu of a site

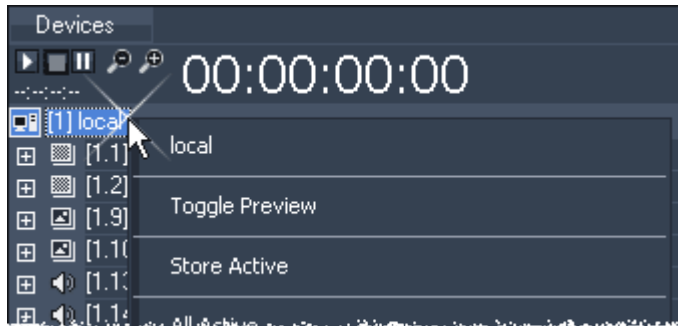

**[Site Name]**

The site's name (in the example above: local)

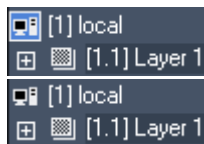

**[Toggle Preview]**

Toggles the site to be included in / excluded from the [preview](#)<sup>232</sup>. When the site is included in the preview the site icon is highlighted in blue as seen in the top image. If it is not in the preview the icon not highlighted.

**[Store Active]**

Stores all active parameters of the site's devices as containers to the sequence.

**[All Active]**

Activates all parameters of all devices of this site (every parameter will turn red).

**[All Active (Partially Active Devices)]**

Activates all parameters of all layers of this site that already have active parameters.

**[Clear All Active]**

De-activates the active status off all parameters of all devices of this site. The values will be kept and not set back to default.

**[Reset All]**

Resets all parameters for all devices of this site to their default values and removes their active status.

**[Rename]**

Enables you to rename the site. You can do this by pressing F2 as well.

**[Remove]**

Removes the site irrevocably from the device tree. You will have to confirm this action in a pop-up window.

**[Hide]**

This command will hide the site in the device list. To show it again, right-click on another site and choose the "Toggle Sides" command as explained below.

**[Toggle Devices]**

Choose if you want to show all devices, hide all devices or show / hide single devices of this site in the device tree. A time-saving way to select and hide more than one layer is using the right-click menu of a device.

**[Toggle Sites]**

Choose which sites you want to show or hide in the device tree.

**[Add Layer]**

Adds one new layer to your site. A pop-up lets you choose the type of layer. This command depends on your PB product.

**[Add Multiple Layers]**

Adds several new layers to your site. A pop-up lets you choose the type of layer. This command depends on your PB product.

**[Create Virtual Site]**

This command will create a Virtual Site out of all selected sites. Please see [Virtual Site](#)<sup>286</sup> for detailed information.

**[Adopt from Site]**

Loads all current values and contents of the chosen site into the layers of this site (timeline programming will not be affected).

**[Toggle Fullscreen]**

This command toggles the site into fullscreen and out of fullscreen.

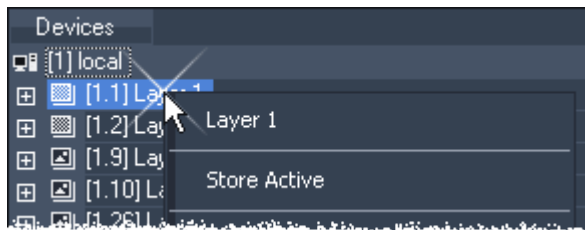
**The context menu of a device or layer****[Device Name]**

Shows the device's / layer's name (in the example above: Layer 1)

**[Store Active]**

Stores all active parameters of the device as containers to the sequence.

**[All Active]**

This command will activate all parameters of this device (every parameter will turn red).

**[Clear All Active]**

De-activates the active status off all parameters of this device. The values will be kept and not set back to default.

**[Reset All]**

Resets all parameters of this layer to their default values and removes their active status.

**[Rename]**

This command will enable you to rename the device. You can also do this by pressing F2.

**[Remove]**

Removes the layer from the site. Please note that the layer will not only be hidden as with the command "Hide".

**[Copy FX Structure]**

This command copies the FX structure of this device in order to provide it for another layer. This refers to the FX types and their order.

[Paste FX Structure]

Copy a FX Structure from another layer first. This command then pastes the FX structure to this layer. If this layer already contains FX, it will add the copied FX structure after the existing FX.

[Remove All FX<sup>328</sup>]

This command removes all FX of this device. Please note: Once an effect is removed from the layer, it won't be available any more for all of the layer's clip containers which used this effect.

[Hide]

This command will hide the device in the device tree.

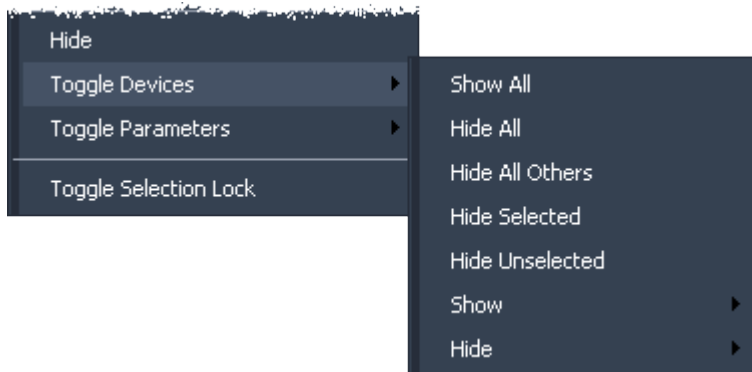

[Toggle Devices]

The pop-up enables you to show and hide layers. This can be done with single or all layers, or depend on your current layer selection.

Selected layers are highlighted blue. To multi-select layers, press CTRL or SHIFT.

For an example refer to the topic "Structure of devices" explains the

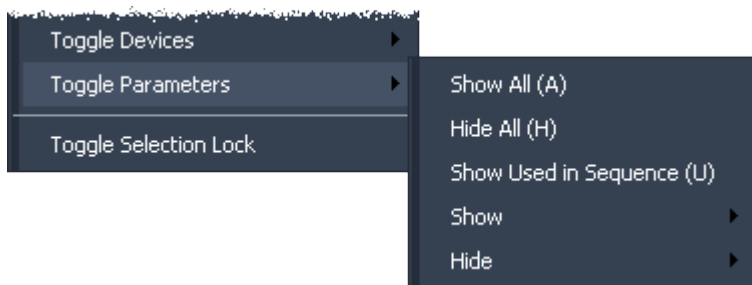

[Toggle Parameters]

The pop-up enables you to show and hide parameters. This can be done with single or all parameters, or depend on your currently used once (stored keys in the sequence).

In addition, the list shows you the [keyboard shortcuts<sup>292</sup>](#) to apply the filtering to any device selection.

[Toggle Selection Lock]

Choose Toggle Selection Lock to lock the current selection. A lock icon will display the locked selection. Clicking on a device beside this selection will load the device into the device control tab. You can modify its parameters without losing the locked selection. This explained in more detail in the next topic "[Device Selection<sup>176</sup>](#)".

**The context menu of a parameter**

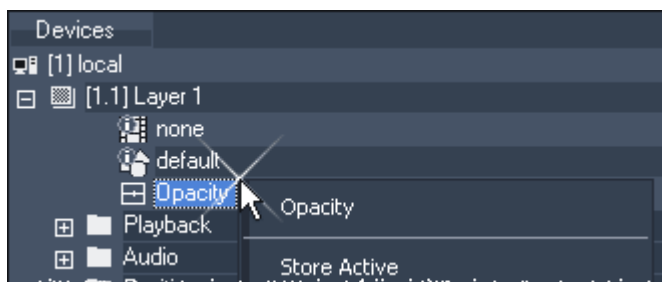

[Parameter Name]

Shows the parameter's (in the example above: Opacity).

[Store Active]

Stores all active parameters of the device as containers to the sequence.

[Active]

Activates the parameter (parameter will turn red).

[Clear Active]

De-activates the active status off this parameters. The value will be kept and not set back to default.

[Reset]

Resets the parameters to its default value and removes its active status.

[Hide]

Hides the parameter in the device tree. To show it again, right-click on the layer and choose the "Toggle Parameter" command as explained above. The topic "[Structure of the Device View](#)<sup>178</sup>" shows as well the keyboard shortcuts to toggle parameters.

[Toggle Key Mode]

Allows you to detach the parameters events from the existing clip containers. This applies to all sequences.

Please note: This command cannot be undone. For more details see the topic "[Programming](#)<sup>268</sup>".

[Load into Curve Editor]

To edit the parameter curve do a right-click and choose "Load into Curve Editor" or double-click on the Curve Editor icon in front of the parameters (you will find the Curve Editor Tab under Tabs - Curve Editor). Please see the [Curve Editor](#)<sup>161</sup> description for detailed information.

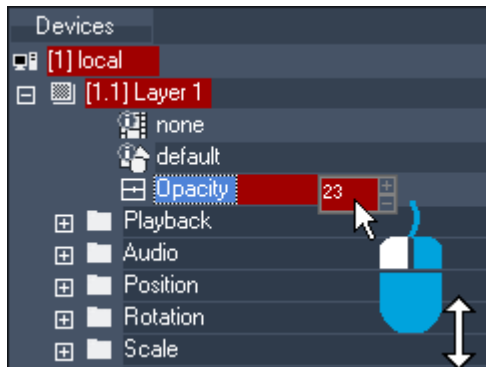

The device tree also allows direct changes to any parameter value:

- 1) left-click the value and drag it
- 2) double-click in the numeric box and enter a new value using the keyboard.

### 5.2.3.8.3 DEVICE SELECTION

This topic explains ways how to select sites (i.e. Players and Servers) and devices (i.e. layers). If you like to save selection-groups, please refer to the topic "[Groups](#)<sup>251</sup>".

#### Selection of a site or device

Select a site (server) or a device (layer) by left-clicking on it. The layer icon will turn blue and the selected device will be loaded into the device control tab.

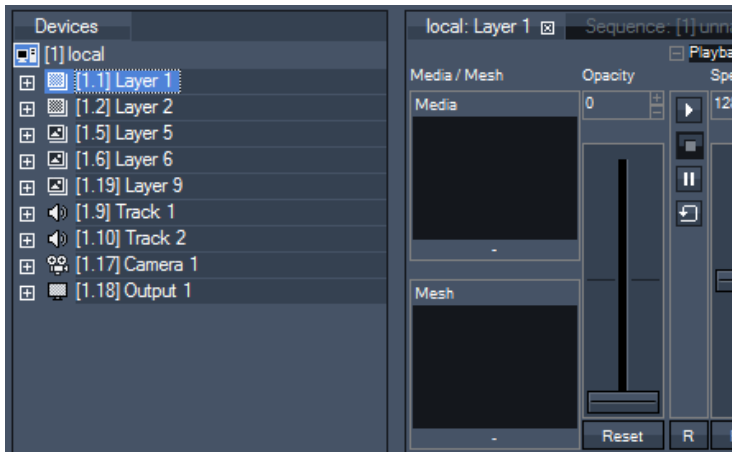

#### Multi-Selection

To select several devices, select the first one and hold down the CTRL or the SHIFT key while clicking on other devices to select them, too.

When several devices are selected, the last one selected will be loaded into the [Device Control tab](#)<sup>164</sup>.

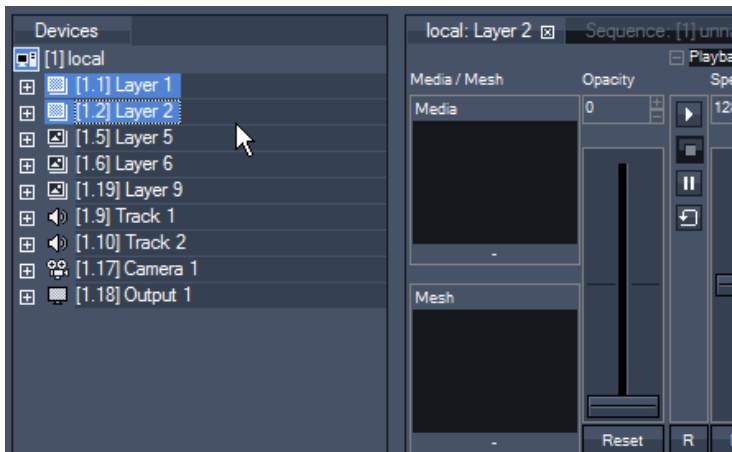

Once you have done your selection, all parameter changes (adding new media/mesh, moving a fader) on one of these selected layers will be assigned to all selected layers. E.g.: Changing the opacity of layer 1 will result in opacity changes in all selected layers.



## Selection Lock

To keep your multi-selection while modifying other devices, right-click on one of the devices and choose Toggle Selection Lock or press CTRL+L. A lock icon will display the locked device selection.

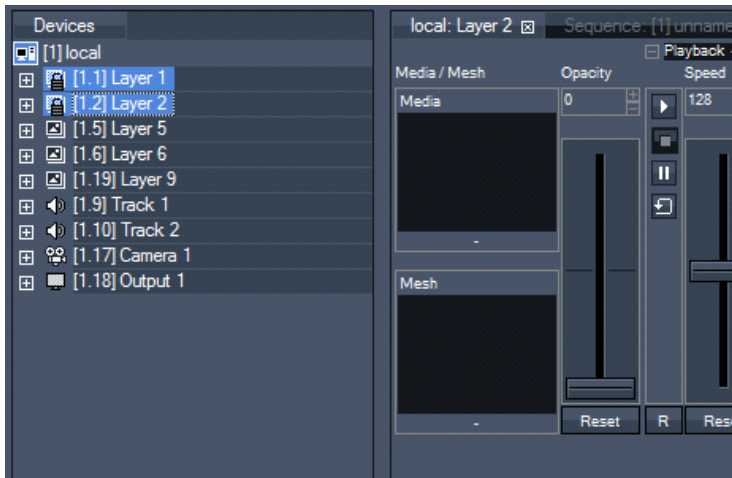

If you now click e.g. on Layer 5, it will be loaded into the device control tab. You are able to modify this layer and keep your selection for later purposes.

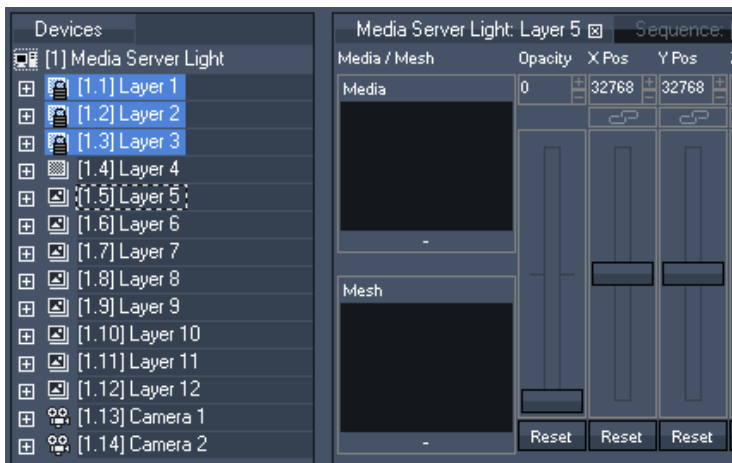

### 5.2.3.8.4 STRUCTURE OF THE DEVICE VIEW

This topic shows how to hide and show layers and parameters in order to adjust the Device Tree.

#### Hide devices

As best practice we recommend to display only those devices or layers that are used in the show. This allows faster navigating through the device tree when a lot of devices are loaded in the project. Choose the "Toggle Device" entry from the site context menu to hide or show individual items or all items at once.

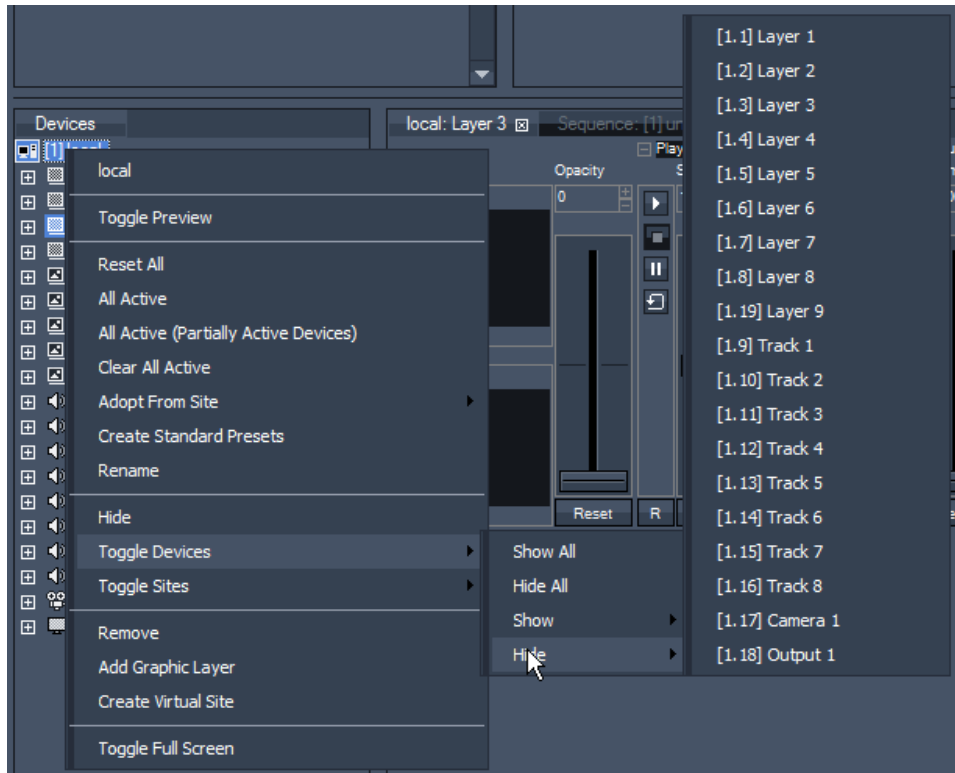

Using multi-selection to show/hide several devices could be time-saving.

To select several devices, select the first one and use holding down the CTRL or the SHIFT key while clicking on other devices to select them too.

Right-click on one of these layers and choose Hide from the context menu.

## Show devices

Once the devices are hidden, right-click on the site and choose Toggle Devices -Show All or -Show to display all or parts of them again.

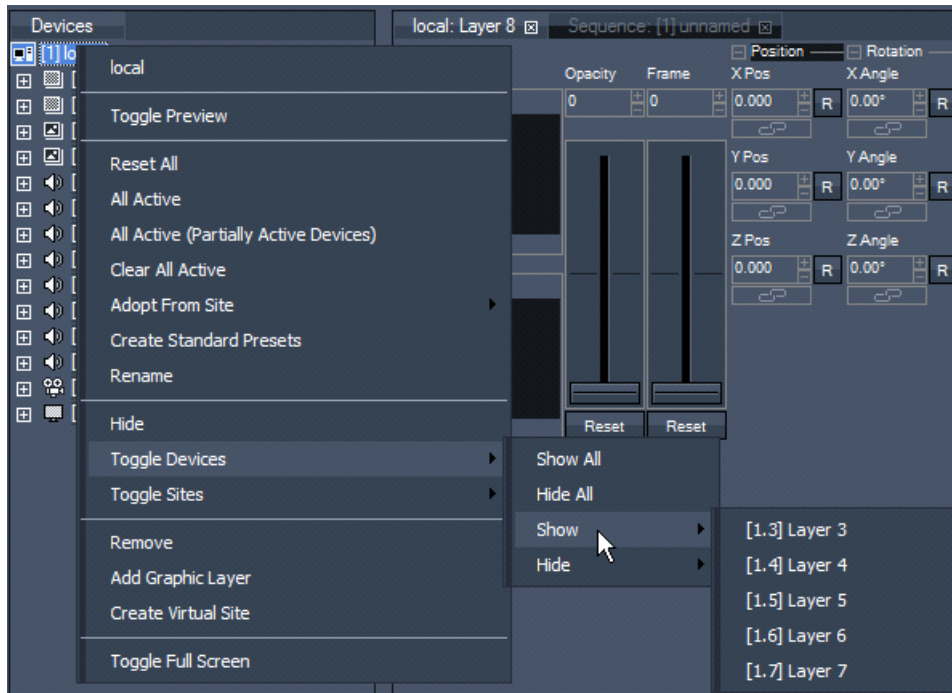

## Hide and show parameters

The device tree can also be filtered on the parameter level. To do so, right-click on any device and choose Toggle Parameter to hide or show individual items or all items at once. In addition, the list shows you the keyboard shortcuts to apply the filtering to any device selection.

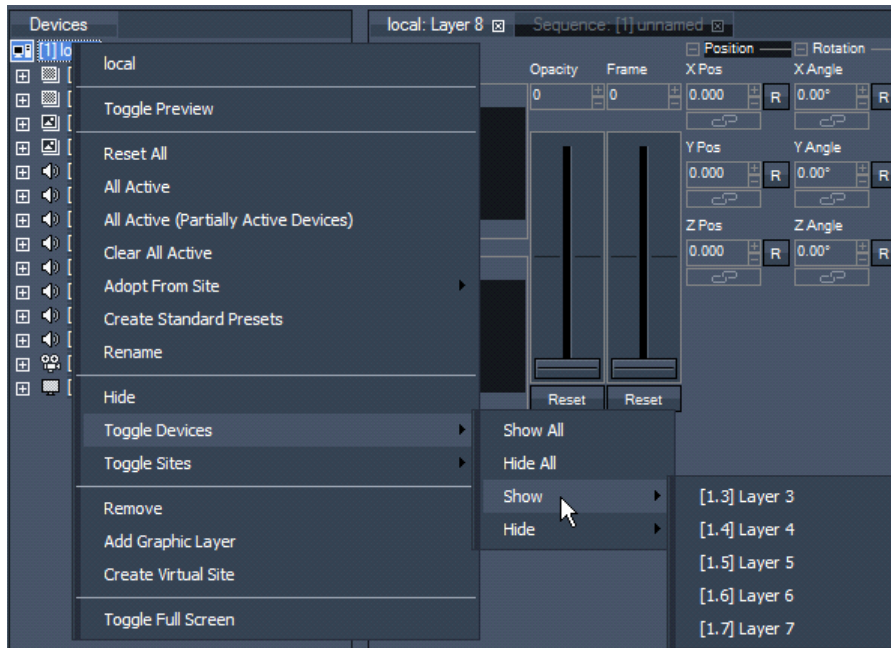

When working in device tree, the following shortcuts apply to current selected device:

- A Show all Parameters

- 
- H Hide all Parameters
  - U Show only Parameters used in Sequence/Show all Parameters
  - M Show/Hide Media Parameter
  - O Show/Hide Mesh (Object) Parameter
  - I Show/Hide Opacity Parameter
  - V Expanse/Collapse Playback Parameters
  - X Expanse/Collapse Audio Parameters
  - P Expanse/Collapse Position Parameters
  - R Expanse/Collapse Rotation Parameters
  - S Expanse/Collapse Scale Parameters
  - T Expanse/Collapse Rotation Pivot Parameters
  - D Expanse/Collapse Scale Pivot Parameters
  - B Expanse/Collapse Blend Mode Parameter
  - F Expanse/Collapse FX Parameters
  - G Expanse/Collapse Particle System Parameters

### 5.2.3.9 DEVICE TYPES

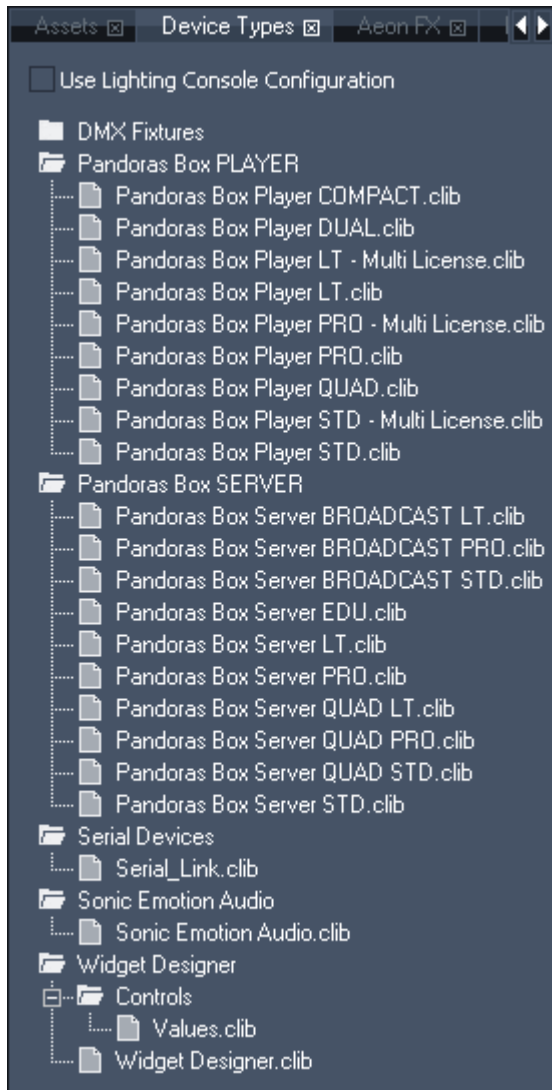

The Device Types tab shows you the contents of the built-in device library.

From this device list you may choose any device and drag & drop it into the device tree list to control it within your current project.

If you are adding a "Multi License" item a pop-up will ask how many licenses should be applied. The number of licenses depends on the number of dongles used and will result in the multiple number of Video Layers, Camera and Output layers. Hence, whilst a normal Player STD consists of 2 Video Layers and 1 render output (1 Camera + 1 Output), the same Player started with two dongles will have 4 Video Layers and 2 render outputs. See the Product Overview for more information regarding the layer and output count.

Please note that starting a system with multiple licenses is only possible for certain Players and requires absolutely identical dongles. Differences can be an additional Widget Designer license, or supporting version 4.x

Please note:

When adding a Pandoras Box device to the device tree, the node icon will show a red "!". This means that you will need to set up the IP address of the device via the [Inspector tab](#)<sup>206</sup> and make sure that the device is available in the network in order to connect to it.

If you are starting to program a show and the client systems are already connected you may drag them from the Assets tab instead.

Using Lighting Console Configuration

With the new dynamic layer structures, users can now easily add more parameters and effects to any layer. In

order to facilitate the control, users may start Pandoras Box in a dedicated Lighting Console Mode or simply create and extend the DMX library from within the interface. This means that any parameter can now be individually patched.

In the lighting console configuration the most relevant parameters are automatically patched and the sites will have Multi-FX added and patched as well. Within these Multi-FX you will be able to choose FX from the whole FX range.

Please find more information in the respective chapters:

- Layout and commands from the [Device Tree tab](#)<sup>168</sup>
- Controls, faders and values information in the [Device Control tab](#)<sup>296</sup>
- Programming and storing containers and navigating through the [Sequence tab](#)<sup>260</sup>
- Detailed information about each device, e.g. a Video Layer or Serial Link device, in the topic "[Device Control](#)"<sup>296</sup>

### 5.2.3.10 DEVICE VIEWER

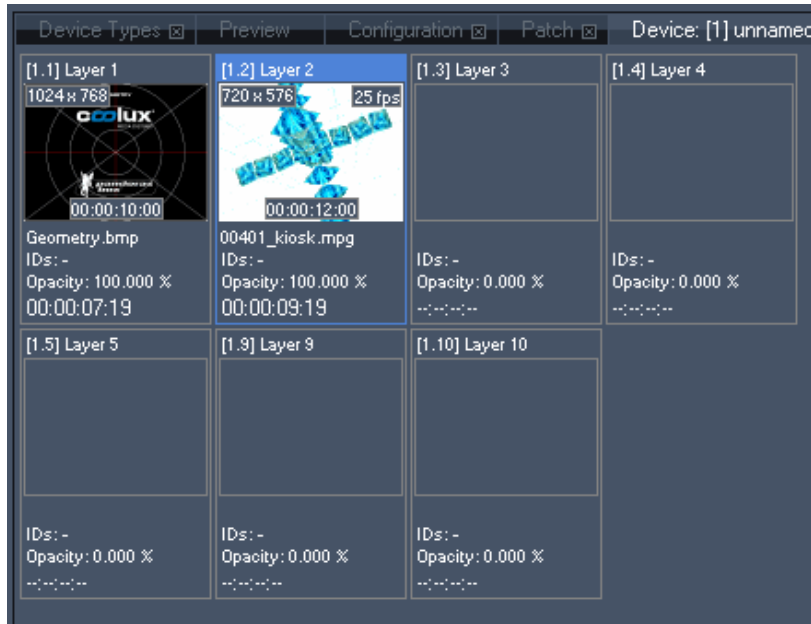

The device viewer shows an overview of the loaded content and additional media information, based on the selected node item in the device tree.

Please note:

Only devices displayed in the device tree are shown in the device tab (no hidden devices).

In the top left corner you will see the media size, in the top right corner the frame rate for videos is shown. On the bottom of the thumbnail the clip container length is displayed. Below the thumbnail you see the media's name, its DMX file and folder ID and the current opacity value. The last entry at the bottom shows the asset's countdown (when it is stored to the timeline).

Click on a layer field here in the device viewer in order to select the layer in the Device Tree.

### 5.2.3.11 ENCODER EXTENSION TAB

The built-in Pandoras Box Encoder Extension allows to transcode most AVI -and Quicktime- as well as WMV files to Mpeg1 or 2 up to a 4k resolution. Please see this chapter ["Encoder Extension"](#)<sup>104</sup> for more information...

### 5.2.3.12 FIREFLY PARTICLES

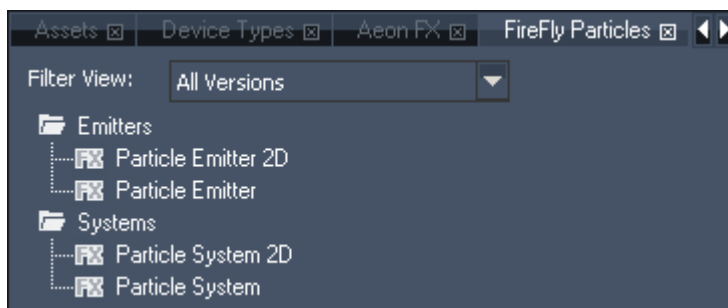

The FireFly™ particle system allows creating elaborate real-time particle effects in a true interactive 3D compositing space. Various emitters can be setup and applied with forces such as Wind & Gravity. The

3D and 2D particle systems are available on Pandoras Box Server systems whilst the Player systems support 2D particles only.

Basics information:

In order to use the Firefly Particles you have to add a Particle System to a video or graphic layer first. As a second step you may then drag one or several emitters onto the specific system.

### Adding a Particle System to a layer

To add a particle system to your layer, drag and drop the 2D or 3D Particle System from the FireFly Particles Tab on the layer, just like you are adding FX to the layer. The particle system will appear right from the default layer parameters, see image below.

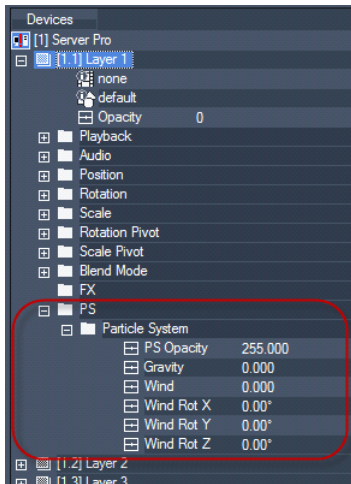
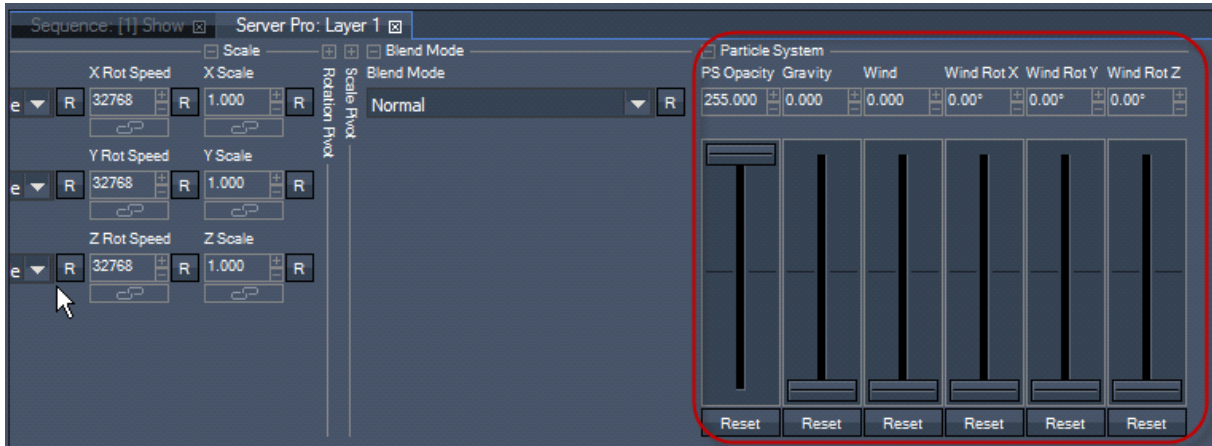

If you expand the layer in the device tree tab now, you will see that there is a new entry for the particle system in the folder "PS", see image to the left.

With the particle system you define the environment, setting up the opacity of the system, Gravity and Wind. To see how these settings affect the emitters, you have to add at least one emitter.

### Adding a Particle Emitter to a Particle System

To add a particle emitter to your system, drag and drop the 2D or 3D Particle Emitter from the FireFly Particles Tab onto the system, not the layer:

- either into the Device Controls tab where you can see the faders of the Particle System
- or into the Device Tree tab, onto the entry that says "Particle System"

The particle system section is now enhanced by the emitter parameters.

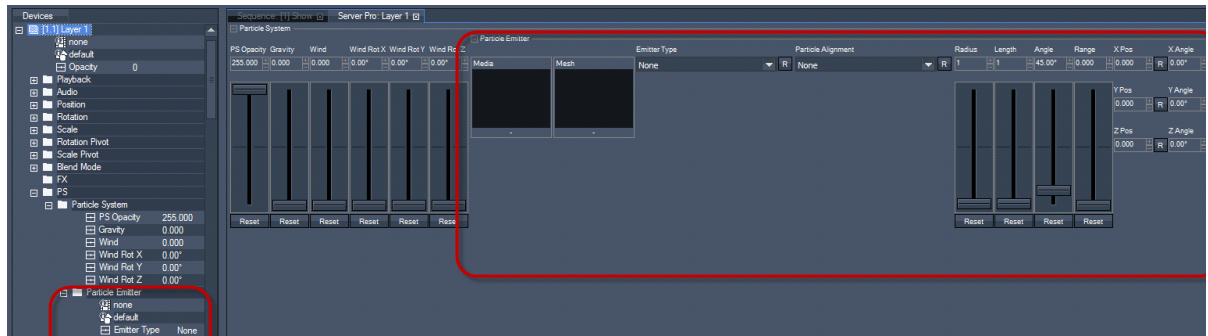

## System and Emitter: Parameter overview

### SYSTEM

Parameter	Description	Value Range	Default
PS Opacity	Opacity of the whole Particle System	0-255	255
Gravity	Amount of Gravity affecting the emitters	0.000-1000.000	0.000
Wind	Amount of Wind affecting the emitters	0.000-1000.000	0.000
Wind Rot X		0-360°	0°
Wind Rot Y		0-360°	0°
Wind Rot Z		0-360°	0°

### EMITTER

Parameter	Description	Value Range	Default
Media	Media File used as Emitter		None
Mesh	Object File for the Media		None
Emitter Type	Choose how the emitter will appear:	None, Point, Line, Area, Circle, Sphere, Cylinder	None
Particle Alignment	Alignment of the emitting particles	None, Billboarding, Flight Direction	None
Radius	Radius of the emitter type, in units (a PB fullscreen is always 16 units wide)	0-100	1
Length	the emitter sources dimension	0-100	1
Angle	Angle of emitting particles	0-360°	45°
Range	Range	0-100	0.000
X Pos	Position of emitting particles in X	-999.999 - +999.999	0.000
Y Pos	Position of emitting particles in Y	-999.999 - +999.999	0.000
Z Pos	Position of emitting particles in Z	-999.999 - +999.999	0.000
X Angle	X Angle of particle source	-1000° - +1000°	0°
Y Angle	Y Angle of particle source	-1000° - +1000°	0°
Z Angle	Z Angle of particle source	-1000° - +1000°	0°
Rot Pivot X Pos	X Pos of rotation pivot	-999.999 - +999.999	0.000
Rot Pivot Y Pos	Y Pos of rotation pivot	-999.999 - +999.999	0.000



Rot Pivot Z Pos	Z Pos of rotation pivot	-999.999 - +999.999	0.000
Count/Sec	Amount of particles per second	0.000 – 1000.000	100.000
Time To Live (Sec)	Amount of seconds a particle will live until it fades out and disappears	0.000 – 1000.000	5.000
Speed *	Define the particles speed		Start:20, End: 20
X Scale *	Define the particles X Scale		Start:0.1, End: 0.1
Y Scale *	Define the particles Y Scale		Start:0.1, End: 0.1
Z Scale *	Define the particles Z Scale		Start:0.1, End: 0.1
X Rot *	Define the particles X Rotation value		Start:0, End: 0
Y Rot *	Define the particles Y Rotation value		Start:0, End: 0
Z Rot *	Define the particles Z Rotation value		Start:0, End: 0
Mass	Mass of particles; the flight behavior of an objects is defined by its momentum (mass*velocity or speed); the momentum decreases the influence of gravity and wind	1.000 – 100.00	1.000
Drag	Drag of particles; as drag is a force which decreases the velocity / speed of an object it resists the particle's motion, thus it increases the influence of gravity and wind	0.000 – 1000.000	0.000
Color *	Color added to particles.	Choose color	
Particle Opacity *	Define the particles opacity over lifetime	Choose color	Start:white (full opacity), End: black (opacity=0)

\*: The parameters marked with \* allow defining a curve over the particles lifetime. A right-click into the faders background adds a new point in time whereto a parameter can be defined.

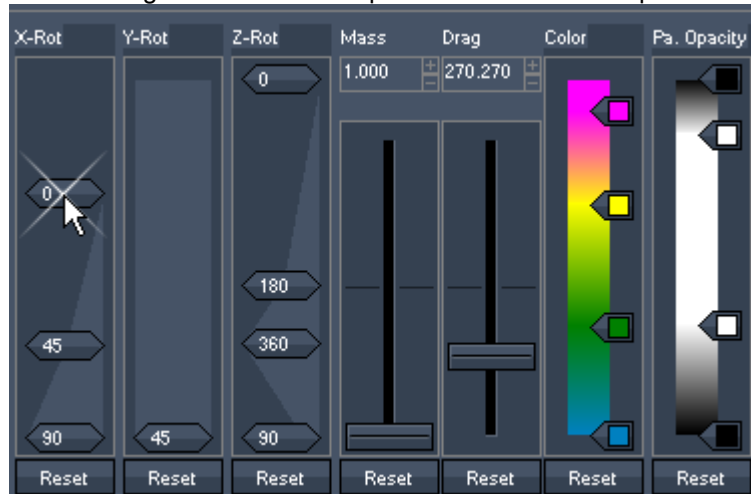

## Particle Examples

In the following examples these files are used:

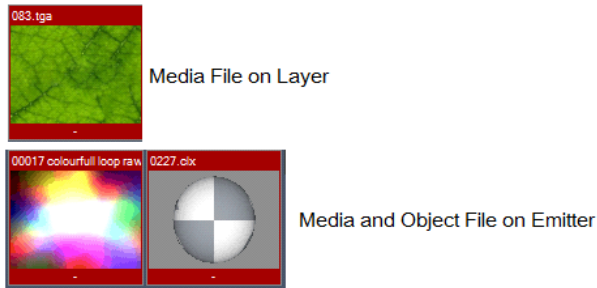

In the examples only the parameter values different from the default values are mentioned.

### Example 1:

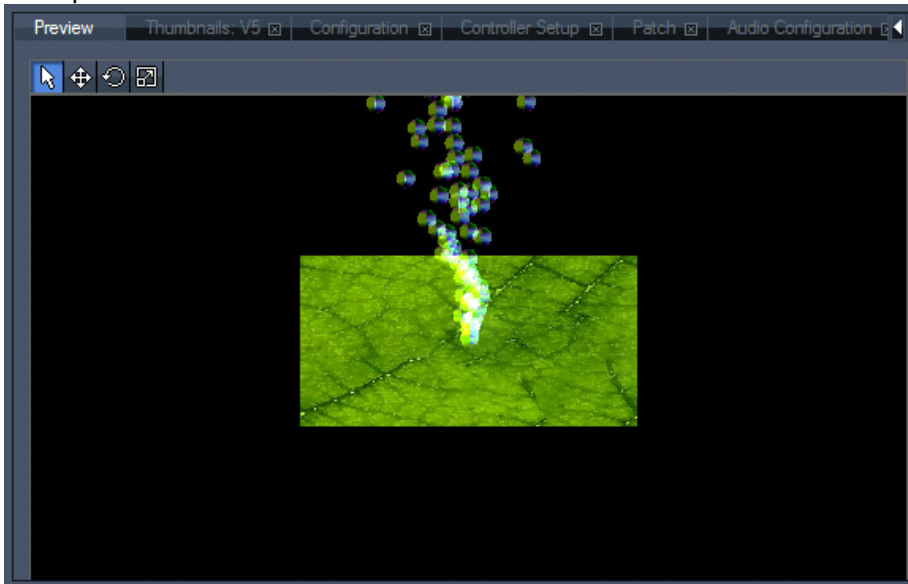

Image above: Here the emitter type is set to “Point”, there is no gravity set for the particle system.

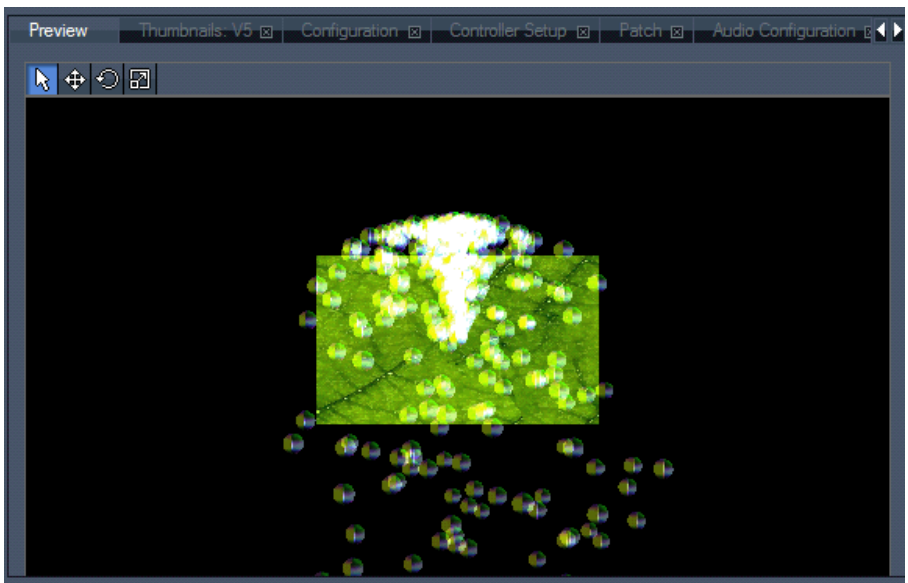
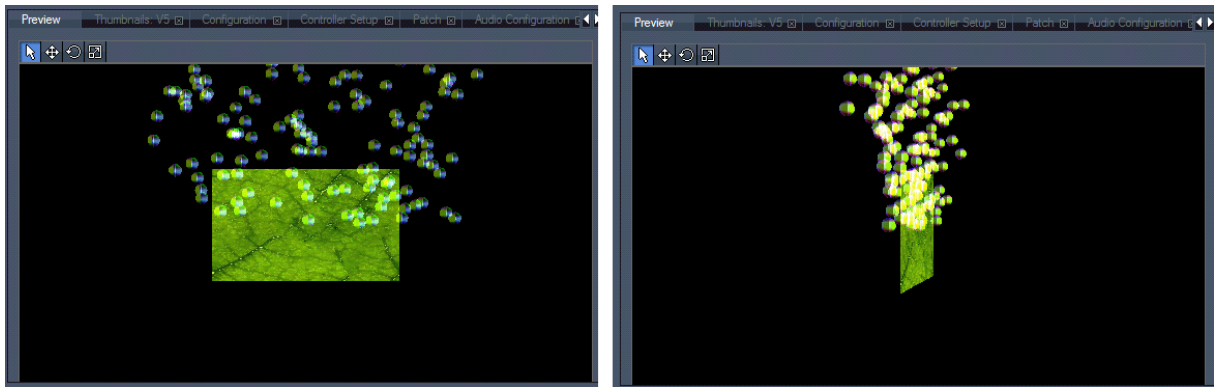
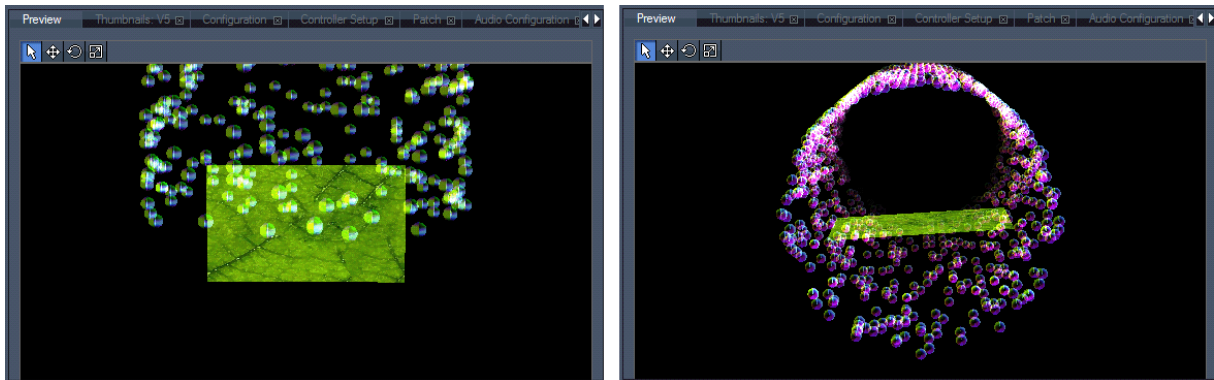

Image above: The particle systems gravity is now set to 155 – the emitters will fall down after they flew into positive Y direction.



Images above: The emitter type is changed to “Line”, with the Radius set to 12. No gravity. Left) Viewed from the front, Right) viewed from the side.



Images above: The emitter type is changed to “Circle”, with the Radius set to 12. No gravity. Left) Viewed from the front, Right) viewed from downside.

### 5.2.3.13 GROUP VIEW

The group view lets you create, edit and select groups in a browser view. The same functions are accessible in the [Project tab > Groups](#) <sup>251</sup>.

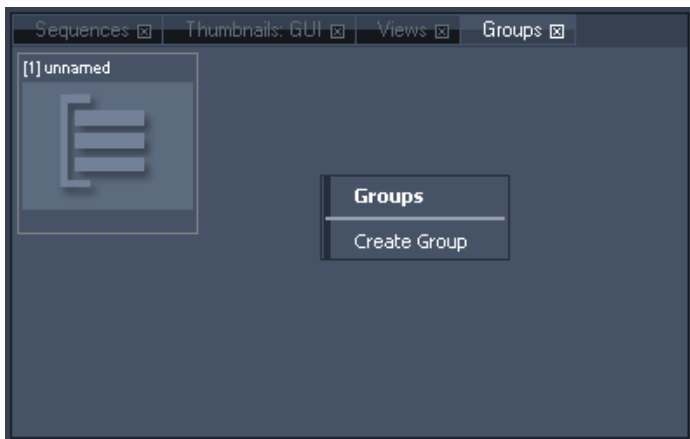

To create a new group, select multiple devices in the device tree.

Then right-click in the group view tab to create a new group based on the current selection.

To select a group, only press ESC to clear the current selection and click on the group item in the group browser to select all group members in the device tree.

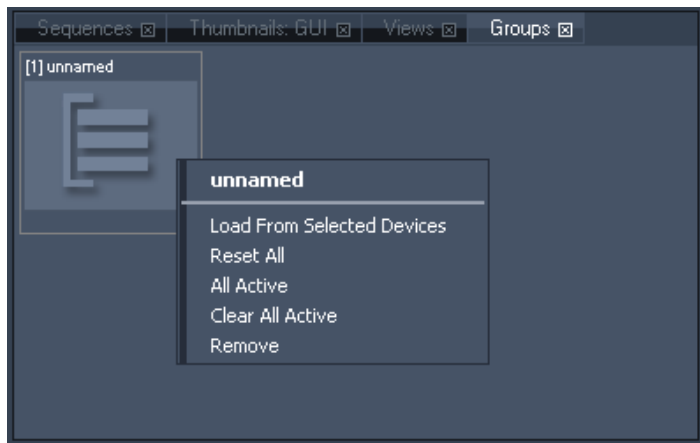

If you want to edit an existing group, right-click on the desired group and choose one of the following actions:

- Load From Selected Devices

This command will overwrite the actual group selection with the current selection in the device tree.

- Reset All

This command will reset all parameters for all devices stored within this group.

- All Active

This command will activate all parameters of all devices stored within this group.

- Clear All Active

This command will de-activate all parameters of all devices stored within this group.

- Remove

This command will delete the group from the project.

### 5.2.3.14 INSPECTOR

The inspector is a dynamic, context sensitive property window that will constantly display the properties of the selected items in the user interface.

Based on the selected item, the inspector offers different control and property settings.

Since version 5.1 it is possible to multi-select items and modify them all at once. This applies to all possible items such as key frames and containers, cues, files and layers.

If you select items that have different settings at the time you select them the changes done apply to all in the same way. That is, a setting that is possible to be a toggle function (e.g. a check box) would not toggle the other way if it was already used in one of the selected items. Please note, there is no grayed out symbol if items with different settings are within the selection. The options shown in the inspector always refer to the item last selected or to the one afterwards chosen via the drop-down menu the inspector offers. Underneath the drop-down you see the information how many more items you have currently selected.

The only exception of the rule are explained in the [file inspector](#)<sup>190</sup>.

Generally changes made for IDs apply to the first item selected. The IDs for the other items are set incrementally

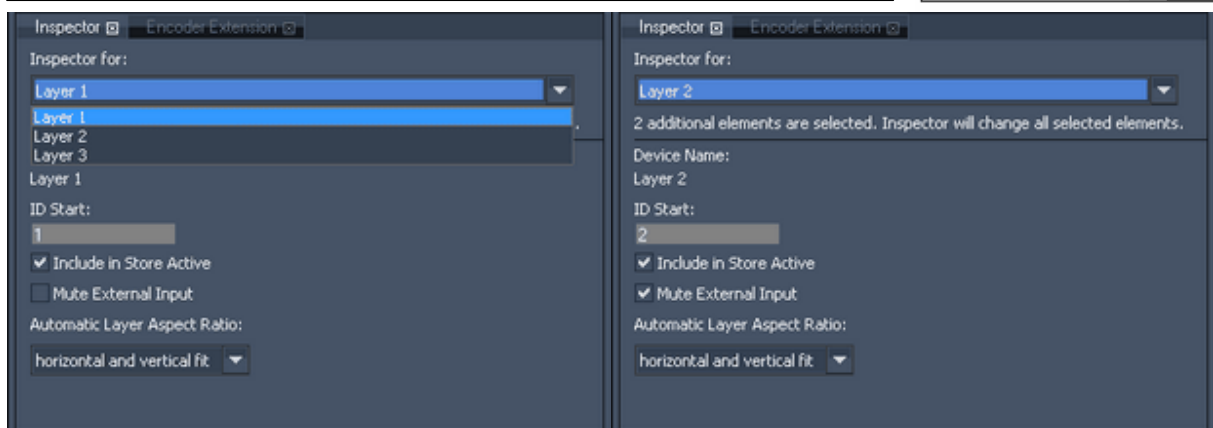

The different Inspectors are described in the following order:

Inspectors to be called from Project Tab:

- [File Inspector](#)<sup>190</sup>
- [Browser Inspector](#)<sup>192</sup>
- [Image Sequence Inspector](#)<sup>194</sup>
- [Playlist Inspector](#)<sup>196</sup>
- [Text Inspector](#)<sup>197</sup>
- [Folder Inspector](#)<sup>198</sup>
- [Tab Button Inspector](#)<sup>199</sup>
- [Sequence Inspector](#)<sup>200</sup>

Inspectors to be called from Timeline Tab:

- [Clip Summary Inspector](#)<sup>201</sup>
- [Clip Inspector](#)<sup>202</sup>
- [Object Inspector](#)<sup>195</sup>
- [Parameter Key frame Inspector](#)<sup>203</sup>
- [Cue Inspector](#)<sup>204</sup>

Inspectors to be called from Device Tree:

- [Device Inspector](#)<sup>206</sup>
- [Video and Graphic Layer Inspector](#)<sup>208</sup>
- [Pointer Inspector](#)<sup>210</sup>
- [Light Layer Inspector](#)<sup>208</sup>
- [Track Inspector](#)<sup>213</sup>
- [Camera Inspector](#)<sup>214</sup>
- [Output Inspector](#)<sup>215</sup>

### 5.2.3.14.1 FILE INSPECTOR

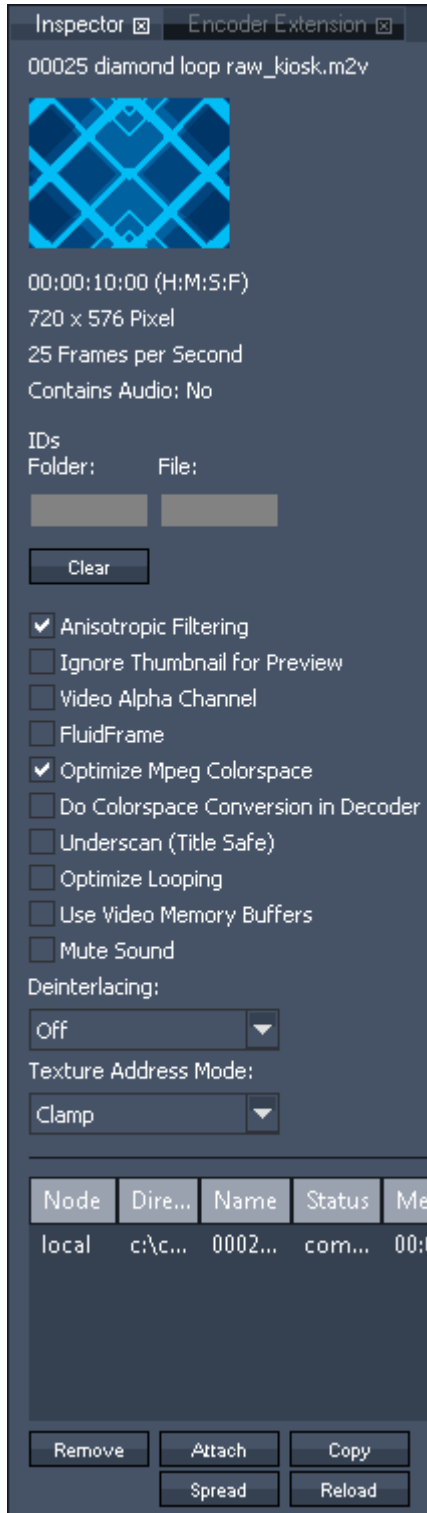

The File Inspector opens when a media file is selected in the [Project tab](#)<sup>248</sup>. The left depicted Inspector shows all properties of a video file. A still image has less options. The File Inspector is also included in the [Folder Inspector](#)<sup>198</sup>. If you do any changes in the Folder Inspector, they apply to all files as if they were multi-selected.

The Inspectors for other resources ([Browser](#)<sup>192</sup>, [Canvas](#)<sup>193</sup>, [Image Sequence](#)<sup>194</sup>, [Object](#)<sup>195</sup>, [Playlist](#)<sup>196</sup>, [Text](#)<sup>197</sup>) are described separately.

Since version 5.7 it is possible to set initial values in the [Configuration tab > Resources](#)<sup>141</sup>, e.g. if you always want an activated FluidFrame option.

#### IDs Folder / File

Set numeric virtual file and folder IDs for [DMX](#)<sup>621</sup>, [PB Automation](#)<sup>1532</sup> and [Widget Designer](#)<sup>864</sup> remote control and [thumbnail exchange](#)<sup>147</sup>. To easily address several files in ascending order, move over to the [Folder Inspector](#)<sup>198</sup> and enter the Folder ID and the start File ID.

Press the button "Clear" to remove the virtual file and folder ID.

#### Anisotropic Filtering

Anisotropic Filtering does pixel smoothing for real-time video and image scaling, default is on.

#### Ignore Thumbnail for Preview

Even if using the "Thumbnail for Preview"-Option (see [Configuration Tab](#)<sup>139</sup>) this file can nevertheless be rendered and played back in full quality instead of showing its thumbnail, (e.g.. if you need to know where exactly the video playback currently is). Check the Ignore Thumbnail for Preview option to make this exception for this file.

#### Video Alpha channel

If movie type supports embedded alpha, this option lets you activate the alpha channel. The alpha channel inside images is always activated.

#### FluidFrame

Choose this option for slow motion or smooth motion frame-adaptive frameblending and framerate conversion. With FluidFrame™, a smooth cross-conversion that can take any input and output framerate, supporting both interlaced and progressive sources and clips is possible now. This way for example 59.94 video input signals are displayed without any frame drop on 60hz output displays. FluidFrame™ can therefore also handle 50hz to 60hz real-time conversions.

In addition to this, it allows smooth playback of highspeed frame rates such as 50 or 60p content and higher. FluidFrame™ Technology can be applied to any live video input or content playback scenario ranging from straight forward Live Video processing to the synchronization of multiple HD SDI streams for Live Stereo 3D applications.

#### Please note:

When using fluid frame with 50p, 60p files or live inputs, please check the option "[High Performance Mode](#)<sup>158</sup>" to ensure smooth playback. In all other cases the High Performance Mode should NOT be used because it requires more system and GPU RAM.

### Optimize Mpeg Colospace

MPEG has a reduced colospace, this option stretches the colospace (black will become a real black).

### Do Colospace Conversion in Decoder

The mpeg format saves colors in the so called YUV colospace, whilst Pandoras Box requires the RGB colospace. Per default the YUV>RGB conversion is done by the graphics card. The advantage is that performance is saved. The disadvantage is that the card's conversion is different to the one used when actually creating an \*.mpeg file. This is for example the case when taking use of any encoding features in Pandoras Box, i.e. Video Export or the Encoder Extension. But also when encoding an mpeg with other programs and tools.

In other words, the Video Export converts RGB>YUV, when using this exported file in Pandoras Box, the graphics card converts YUV>RGB. As the two ways of converting colors do not match, there are different RGB values. To convert in the same way, tick the check box. Note that this will consume more performance and is optimized for the Pandoras Box encoding and decoding features. There still could be a color difference when encoding mpegs with third party tools.

This option can be used in addition to stretching the colospace, as described above.

### Underscan (Title Safe)

This option is mostly designated for Live Input Signals to crop the image to the Title Safe Area.

### Optimize Looping

Check this option if a looped file does not play back smoothly when jumping from the last to the first frame.

### Use Video Memory Buffers

If the system memory (RAM) tends to run low and you have a powerful graphics card, this option may be activated to use the video memory buffers of your graphics card in order to reduce the system memory load.

### Mute Sound:

If a video files contains audio as well, you may check this option if you want to completely mute the sound part of the video file without using the Volume fader.

### Deinterlacing:

This is a real-time (zero-delay) de-interlacer for live-input sources based on top or bottom field first. The option fieldblending adds a half-frame delay.

### Texture Address Mode

This setting determines how the texture is going to be addressed on objects that use texture coordinates beyond the range [0-1].

- Wrap: the texture will be repeated (wrapped) to infinity
- Clamp (by default): the texture's last pixel will be stretched out to infinity
- Mirror: the texture will be flipped back-and-forth to infinity.

### File location table

Please see the [next topic](#)<sup>192</sup> for a detailed explanations.

- Remove: to remove a specific entry
- Attach: used to attach a different file on individual machines when files are not spread.
- Copy: manual copy of files from one location to another.
- Spread: multi-file transfer to all available clients that are spared from spread.
- Reload: reloads media

Please note, that the changes made in the File location table do NOT apply in a multi-inspector. If you have more than one file selected these changes only apply to one file at time.

### 5.2.3.14.1 ATTACHING FILES

The attach function is a very powerful tool in Pandoras Box. In a nutshell, it achieves that different files are loaded in different clients even though the master is programmed with only one file. This chapter shows three exemplary applications after an explanation of the file location list

Example: A Manager is started as a master system and two Players Clients are connected to it.

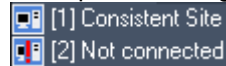
 All three systems are listed as consistent in the Device Tree. The default spreading behavior is not changed in the [Configuration tab > Resources](#)<sup>[141]</sup>.

As soon as a file is dragged from one of the system's hard disks into the project (see [Media Files](#))<sup>[248]</sup>, it is spread to the other systems in the Device Tree. That means it is copied via the network to an according file path on the others systems. Selecting the file in the Project loads the [File Inspector](#)<sup>[190]</sup> and as described in the last chapter it includes the file location list. For our example it looks similar to this picture.

### 5.2.3.14.2 BROWSER INSPECTOR

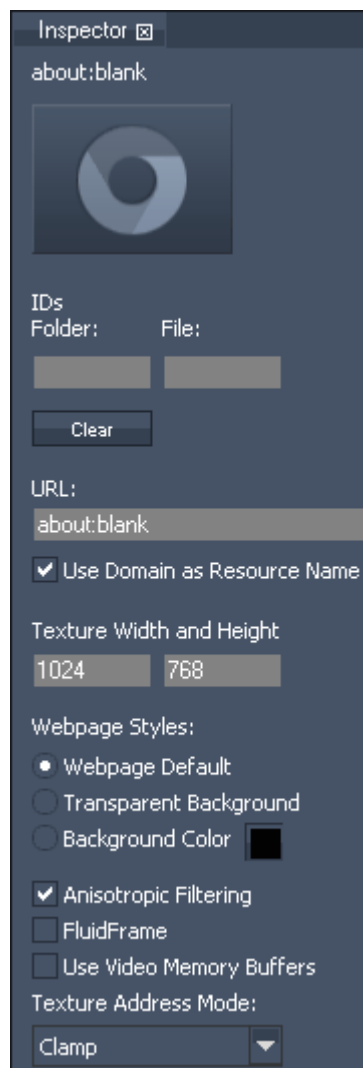

The Browser Inspector opens when a browser asset is selected in the Project tab. Please refer to the chapter about media files in the [Project tab](#)<sup>[248]</sup> if you like to know how to create and work with a browser asset. If your displayed web page includes links you would like to click, please read the chapter about [Layer Picking](#)<sup>[244]</sup>. If you like to set up initial values for new Browsers, please refer to the Configuration tab > [Resources](#)<sup>[141]</sup>.

#### IDs Folder / File

Set numeric virtual file and folder IDs for [DMX](#)<sup>[621]</sup>, [PB Automation](#)<sup>[1532]</sup> and [Widget Designer](#)<sup>[864]</sup> remote control and [thumbnail exchange](#)<sup>[147]</sup>.

#### Clear

Press "Clear" to remove the virtual file and folder ID.

#### URL

Enter a web site's address that the browser should open, e.g. <http://www.coolux.de>

If you like to open a web site saved on a hard disk, the syntax for the URL is: `file://host/path`.

Example for local hard disk: `file:///C:/coolux/web site/index.html`

Example for remote hard disk: `file://2.0.0.100/coolux/web site/index.html`

Note that rendering from a remote path will add delay. The space character in the folder name "web site" can also be represented with "%20".

#### Use Domain as Resource Name

If this option is ticked, the browser asset in the Project tab refers to the URL. In this example it is called coolux.de

#### Texture Width and Height

Set the size of the texture the browser renders on.

#### Webpage Styles

Decide how the web page's background should be displayed. You may choose to display it like a normal browser would do, to replace it with transparency or a custom color.



Please see the [File Inspector](#)<sup>190</sup> for the options "Anisotropic Filtering", "FluidFrame" and "Use Video Memory Buffers" and "Texture Address Mode".

Additional, advanced options including font anti-aliasing for web content and FPS settings can be found in the file "tweak\_config.txt" in the installation path, e.g. C:\Program Files (x86)\coolux\Pandoras Box V5 Player Pro Rev 9924\data\config.

### 5.2.3.14.3 CANVAS INSPECTOR

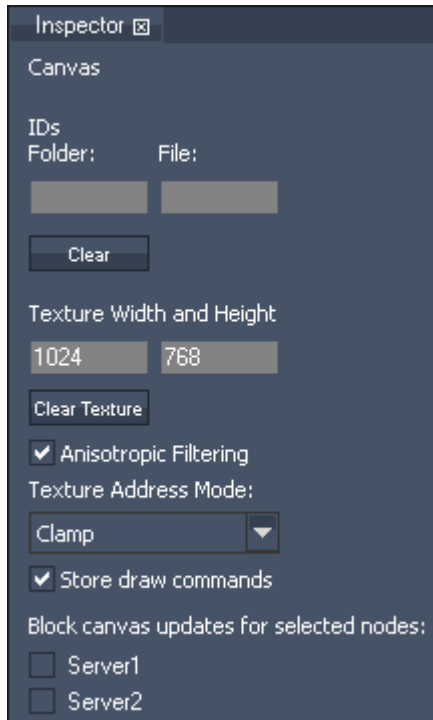

The Canvas Inspector opens when a Canvas is selected in the [Project tab](#)<sup>248</sup>.

#### IDs Folder / File

Set numeric virtual file and folder IDs for [DMX](#)<sup>621</sup>, [PB Automation](#)<sup>1532</sup> and [Widget Designer](#)<sup>864</sup> remote control and [thumbnail exchange](#)<sup>147</sup>.

#### Clear

Press "Clear" to remove the virtual file and folder ID.

#### Texture Width and Height

Set up the size of the Canvas. This should match the size set up in the application used for drawing onto the Canvas.

#### Clear Texture

This deletes all input actions from the Canvas so you can re-start with an empty one.

#### Anisotropic Filtering and Texture Address Mode

Please see the [File Inspector](#)<sup>190</sup>.

#### Store draw commands

When this option is not checked, the input actions are reset when the Canvas is not assigned to a Layer any more. The next time you assign it to a Layer, or load the project, the Canvas has cleared its texture. Check this option to store the input actions in the project file. Please note that this option is not available when drawing with the mouse on a Canvas.

#### Block canvas updates for selected nodes

You can define which connected clients receive and which ones do not receive the Canvas updates in order to save performance.

### 5.2.3.14.4 IMAGE SEQUENCE INSPECTOR



The Image Sequence Inspector opens when an [image sequence](#)<sup>[99]</sup> is selected in the [Project tab](#)<sup>[248]</sup>. Since version 5.7 it is possible to set initial values in the [Configuration tab > Resources](#)<sup>[141]</sup>, e.g. if you always want an activated FluidFrame option.

Number of Threads:

This alters how many threads are called by the Pandoras Box application from the operating system in order to run the sequence. The number of threads must be smaller than the total number of images in the sequence.

Please read the chapter [Image Sequence Formats](#)<sup>[99]</sup> for more information.

Frame Ordering

Choose whether the image sequence should be played

- from the first to the last frame
- from the last to the first frame
- from the first to the last frame and again back the first
- from the last to the first frame and back to the last

Please see the [File Inspector](#)<sup>[190]</sup> for all other options like "Anisotropic Filtering" etc. and the file table.

### 5.2.3.14.5 OBJECT INSPECTOR

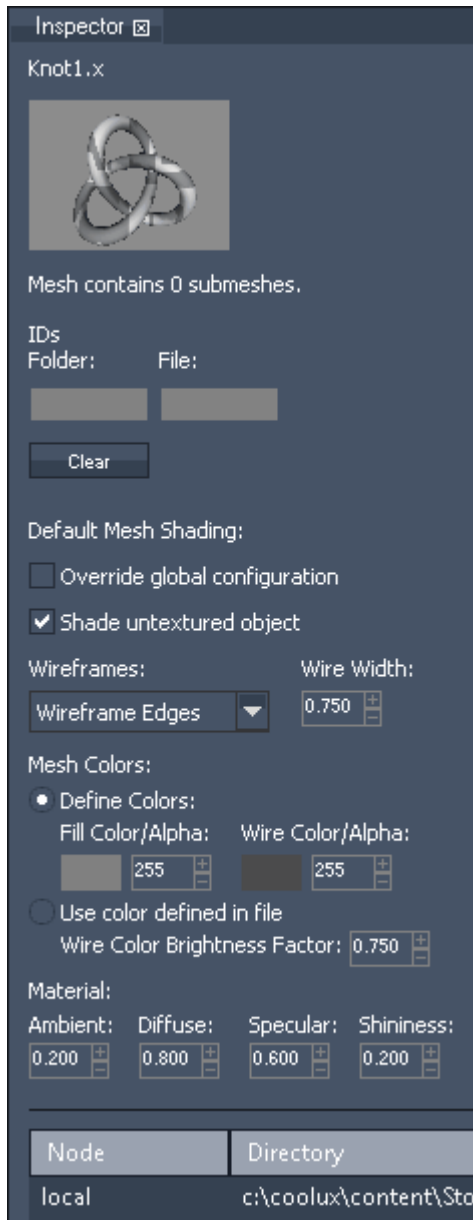

The Object Inspector opens when an object is selected in the [Project tab](#)<sup>248</sup>.

Since version 5.7 it is possible to set initial values in the [Configuration tab > Resources](#)<sup>141</sup>.

#### IDs Folder / File

Set numeric virtual file and folder IDs for [DMX](#)<sup>621</sup>, [PB Automation](#)<sup>1532</sup> and [Widget Designer](#)<sup>864</sup> remote control and [thumbnail exchange](#)<sup>147</sup>.

#### Clear

Press "Clear" to remove the virtual file and folder ID.

#### Override global configuration

In the Configuration tab > [Preview Display](#)<sup>151</sup> you can set up how meshes without an assigned texture are rendered per default. Check this override option to "activate" all further options in order to render the selected mesh different from the default settings.

#### Shade untextured object /.../ Material

Please see the explanation of these settings in the Configuration tab > [Preview Display](#)<sup>151</sup>.

#### File location table

Please see the [File Inspector](#)<sup>190</sup>.

### 5.2.3.14.6 PLAYLIST INSPECTOR

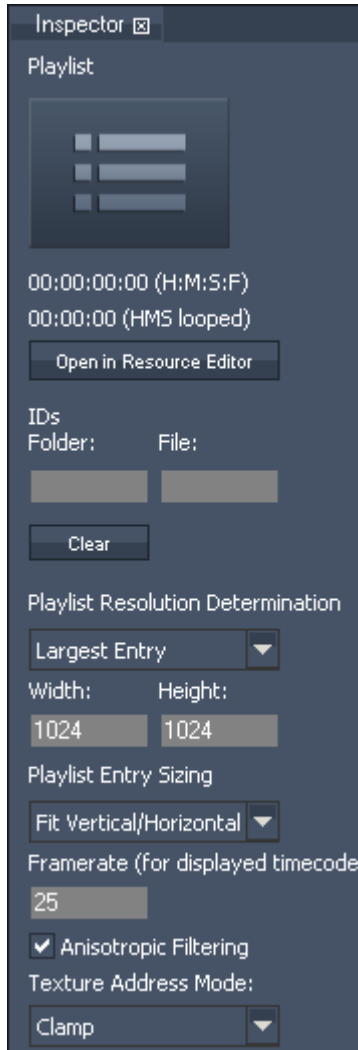

The Playlist Inspector opens when a Playlist is selected in the [Project tab](#)<sup>248</sup>.

Please note that you can set up initial values for new Playlists, in the Configuration tab > [Resources](#)<sup>141</sup>.

First of all the Inspector depicts the duration. The first time refers to the duration if the playlist is played back once (here: 36 sec) and the other if the playlist loops (here: 34 sec). In this example the cross-fade time from the last to first clip is set to 2 seconds.

Click the "Show in Resource Editor" to display the playlist and its content in the [Playlist tab](#)<sup>229</sup>.

#### IDs Folder / File

See the [File Inspector](#)<sup>190</sup>.

#### Playlist Resolution Determination

Choose the texture size each content file should be rendered on. You can for example choose the size from the "Largest Entry" or enter a custom width and height after choosing "User Defined" in the drop-down list.

#### Playlist Entry Sizing

Choose the aspect ratio for the texture each content file is rendered on. "Retain resolution" renders the playlist's content in 1:1 mode, having the advantage of not possibly stretching the content but the disadvantage of not filling the fullscreen and allowing different sizes.

All other option like "Fit Horizontally" or "Stretch Fullsize" possibly alter the content's size. Please see the [Video Layer Inspector](#)<sup>208</sup> for an illustrated explanation for the different Fit-options.

#### Framerate

Choose a framerate for the playback of the playlist, this is only for calculating the duration. The playlist's content files are not converted to

this framerate.

Please see the [File Inspector](#)<sup>190</sup> for "Anisotropic Filtering" and "Texture Address Mode".

### 5.2.3.14.7 TEXT INSPECTOR

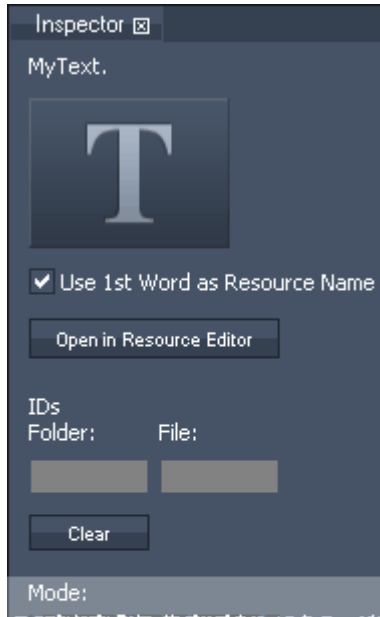

Create your Text Input by right-clicking on a folder in the [Project tab](#)<sup>248</sup> > Add Text Input. Select it to see its properties in the Text Inspector.

#### Use 1st Word as Resource Name

This names the Text input in the Project tab with the first word entered in the [Text Input Editor](#)<sup>277</sup>.

#### Open in Resource Editor

In the Text Input Editor you may set up all options regarding the content of the selected Text Input, e.g. the text itself. Some of the options from the Editor are available in the Text Inspector too and apply to all (multi-) selected Text Inputs. The Editor also allows to transfer style properties to other Text Inputs. Please note, that .net framework 4.0 is needed to display this tab.

#### IDs Folder / File

Set numeric virtual file and folder IDs for [DMX](#)<sup>621</sup>, [PB Automation](#)<sup>1532</sup> and [Widget Designer](#)<sup>864</sup> remote control and [thumbnail exchange](#)<sup>147</sup>.

#### Clear

Press "Clear" to remove the virtual file and folder ID.

#### Mode /.../ Texture Height

Please see the [Text Input Editor](#)<sup>277</sup> for these options.

#### Anisotropic Filtering

Anisotropic Filtering does pixel smoothing for real-time video and image scaling, default is on.

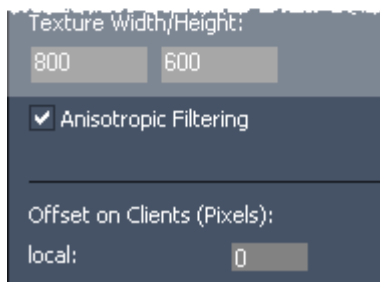

#### Offset on Clients

Enter a pixel value to offset the Text Input for the according Client. This is especially useful when rendering text that spans across multiple outputs from different Clients.

### 5.2.3.14.8 FOLDER INSPECTOR

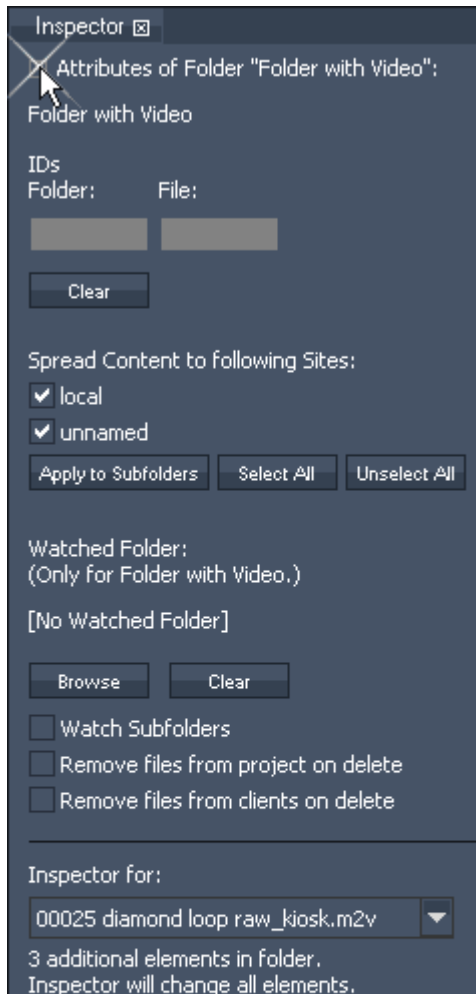

The Folder Inspector opens when a folder is selected in the [Project tab](#)<sup>248</sup>. It includes the properties of the folder itself which can be viewed when clicking the + icon as seen in the left image. In addition it supplies the File Inspector of all files that are part of the selected folder. If you do any changes in this File Inspector, they apply to all files as if they were multi-selected.

#### IDs Folder / File

Set numeric virtual file and folder IDs for [DMX](#)<sup>621</sup>, [PB Automation](#)<sup>1532</sup> and [Widget Designer](#)<sup>864</sup> remote control and [thumbnail exchange](#)<sup>147</sup>. All files in this folder will get the same folder ID, the file ID will be counted up based on the given file ID. If needed you can set the maximum number to 255 in the [Configuration tab > Resources](#)<sup>141</sup>. In that case the folder ID will increase as well.

#### Clear

Press Clear to remove the virtual file and folder ID.

#### Spread Content to following Sites

Per default, the check boxes for the local Master and all connected Clients are ticked, meaning that content is spread to them. In case you don't like to spread content to a Client, deactivate its check box. Note that this does not delete the content if it was already spread.

"Apply to Subfolders" copies the check box status to all subfolders within the selected folder. To (un-)select all check boxes click the according button.

Hint: If you right-click on a folder in the Project tab, you may find the option "Spread to...".

#### Watched Folder

First of all, make sure the option "Monitor changes to files on disk" in the [Configuration tab > Resources](#)<sup>141</sup> is activated. Click the button "Browse" to choose a folder from the hard disk that should be watched. If you like to watch subfolders as well tick the according check box. This will automatically add all subfolders as Watched Folders.

All files that are part of the watched disk's folder will be added

to this Pandoras Box project folder. All files that are afterwards added to the watched folder will automatically appear in the PB folder. Files that are changed will be reloaded by Pandoras Box. Files (and sub folders) that are deleted in the watched folder will remain in the PB folder unless "Remove files from project / clients on delete" is checked.

Click the button "Clear" to delete the Watch function.

#### Inspector for

Please see the [File Inspector](#)<sup>190</sup> for information about these options.

#### Spread Resources

This spreads the entire content of the folder to all sites according to the above option "Spread Content to following Sites".

#### Clean up Inconsistent

Removes all inconsistent files from the master system.

**File Management**

Please see the [File Inspector](#)<sup>190</sup> for information about these options.

**5.2.3.14.9 TAB BUTTON INSPECTOR**

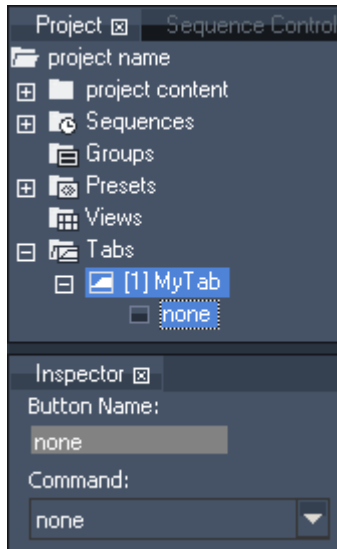

The Tab Button Inspector opens when a Button from a [Tab folder](#)<sup>258</sup> is selected in the [Project tab](#)<sup>248</sup>.

**Button Name**  
Change button name and text

**Command**  
Choose a command from the drop-down list, e.g. "Paste to Selected Devices".

### 5.2.3.14.10 SEQUENCE INSPECTOR

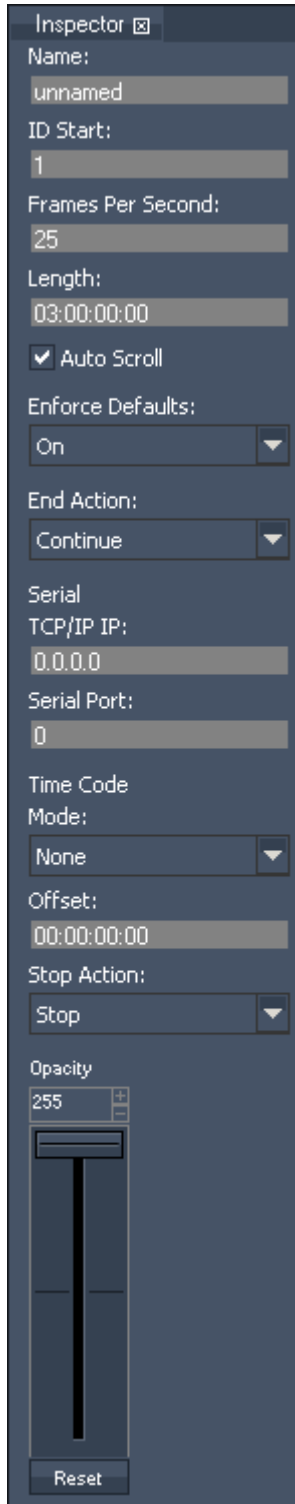

The Sequence Inspector opens when a Sequence is selected in the [Project tab](#)<sup>248</sup>.

Sequence Name

Enter an internal name for the Sequence that is for example shown in the [Project](#)<sup>248</sup>, [Sequence](#)<sup>261</sup> or [Sequence Control](#)<sup>273</sup> tab.

Numeric ID

Enter an ID which is for example used for [DMX](#)<sup>621</sup>, [PB Automation](#)<sup>1532</sup> and [Widget Designer](#)<sup>864</sup> remote control.

Frames per second

This changes the displayed time resolution in the [Sequence tab](#)<sup>261</sup>, i.e. how many frames are available per second. Please note that this does not effect the frame rate used for rendering files! Pandoras Box renders each file according to its own frame rate, the final results seen on a display device depends on the [refresh rate](#)<sup>675</sup> set up in the graphics card driver.

Length of sequence

Default is three hours. You can manually set a new length e.g. 30 minutes by entering 00:30:00:00 or just 300000. Apply the new length with pushing Enter!

Auto Scroll

If Auto Scroll is on (by default), the timeline will always show the area around the nowpointer when it is set to play.

With the Auto Scroll option unchecked, you will be able to scroll to any point of the timeline while the nowpointer is running.

Enforce Defaults

Choose between three states: ON, OFF and ONLY MESH / MEDIA.

Please see [Tracking](#)<sup>269</sup> for detailed description!

End Action

Once the sequence reaches the end of its length, you may choose a specific action:

The sequence stops and jumps to first frame, it will pause or it will continue playing.

Serial

These settings apply when a [Serial Link](#)<sup>729</sup> or TCP/IP device is used to remote control the sequence. The supported commands are listed in the chapter explaining the [TCP/IP input protocol](#)<sup>641</sup>.

[Pandoras Box] <== TCP/IP ==> [Serial Link] <== Serial ==> [Serial Device sending commands to control the PB sequence]

TCP IP / IP

This refers to the Sender's IP address.

Serial port

This refers to the port on the Serial Link where your serial device is attached to. This is a specific serial port on the Serial Link Box, not a TCP/IP port. Please note, that the used TCP/IP port from Pandoras Box is always 23 and can not be configured.

Time Code

These settings apply when a [SMPTE Link](#)<sup>735</sup> is used and set up in the Configuration tab > [SMPTE Time Code](#)<sup>157</sup>.

Mode

NONE - this sequence will not be effected by SMPTE timecode



SEND - this sequence will send its timecode via the SMPTE link device. Please note that if a sequence in your project is set to Send-Mode, all other sequences will be set into None-Mode.  
 RECEIVE - the sequence will be controlled via the incoming SMPTE timecode.

Offset

If needed enter a timecode offset here.

Stop Action

Choose which action should be executed if incoming time code stops. The timeline play mode can be set to Stop, Pause or Continue.

(Sequence) Opacity

This fader works as a master fader for the opacity and volume of the sequence (and all the layers that have clip containers in this sequence).

The sequence opacity works as a value multiplier. If you have the sequence fader at a 50% position (value 127) all containers or layers will be shown with an opacity that is 50% of their stored or active opacity value. If one layer has a current active opacity value of 200, it will be shown with 100. In the same way, another layer that has a stored opacity key will reduce its opacity by one half.

This also means, if a container has no opacity key or value i.e. it is only visible because the [default opacity](#)<sup>139</sup> was set to full, it is not influenced by the sequence fader! This way you can include or exclude layers from the sequence "group".

In the same manner the volume parameter is influenced.

**5.2.3.14.11 CLIP SUMMARY INSPECTOR**

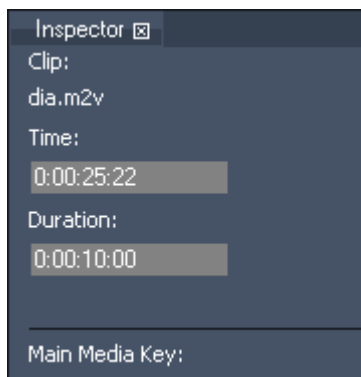

The Clip Summary Inspector opens when a container is selected in the [Sequence tab](#)<sup>264</sup>.

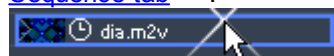

The container is highlighted with a blue outline.

Time

To change the start timecode of the clip, enter the new timecode using the following syntax: enter e.g. 0:00:06:09 or just 609 to get the new time 0:00:06:09.

To just add e.g. two seconds to the current time, enter "++200", to subtract e.g. two seconds, enter "--200".

Duration

To enlarge or to reduce the duration of the clip, enter the new duration using e.g. 0:00:12:00 or just 1200 to get the new duration of 12 seconds.

To just add e.g. two seconds to the current duration, enter "++200", to subtract e.g. two seconds, enter "--200".

All settings below the line are taken from the [Clip Inspector](#)<sup>202</sup>.

### 5.2.3.14.12 CLIP INSPECTOR

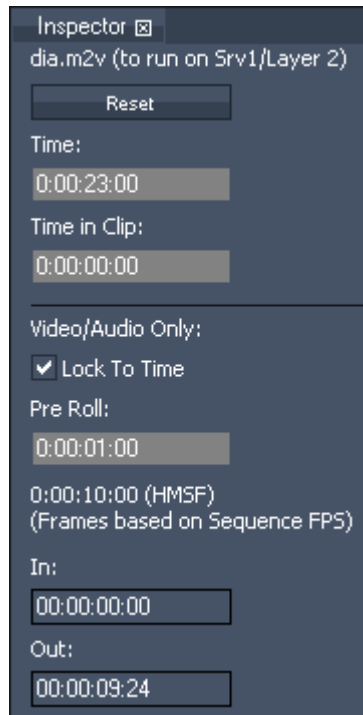

The Clip Inspector opens when a clip within a container is selected in the [Sequence tab](#)<sup>264</sup>.

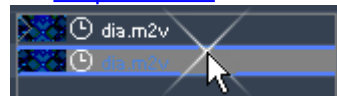

The media track is highlighted in blue. Note, that some effects have their own media clip. Open the FX track and select

this media to see its properties and adjust for example a Pro Roll time. When you select a mesh or object, you will see less options. When selecting an audio clip there is one additional setting "Time Offset Millisecs" that allows to offset the audio content.

#### Reset

This removes the content from the Container and places a "None" key instead.

#### Time

To change the timecode of the start timecode clip, enter the new timecode using the following syntax: enter e. g. 0:00:06:09 or just 609 to get the new time 0:00:06:09.

To just add e. g. two seconds to the current time, enter "++200", to subtract e. g. two seconds, enter "--200".

Note that the container itself stays on the same time. So by shifting the clip, you just start with another frame when entering the container.

When you shift the left container border to the right, i.e. you crop the container, the clip stays at the original time which has the same result as shifting the clip to the left. Empty frames are not possible, thus you can only shift the clip to the left, meaning that you start with a later frame. The "Time in Clip" adjust according to your entry.

#### Time in Clip

Whilst the "Time" expressed the start of the clip regarding the absolute timecode, the Time in Clip expresses the time relative to the clip beginning. So by default, this value is 00:00:00:00 as the clip starts at the same time as the container. If you crop the clip container on its left side, this value will get negative and shows you the starting time of your clip. You can change this value back to 00:00:00:00 to let the video inside the clip start from its beginning.

Note that the "In" parameter also effects which frame of the clip is seen when entering the container.

#### Lock to Time

There are two different modes how a container clip is played back. To switch the mode, you can either use the "Lock To Time" option in the Inspector or the toggle button in the button bar displayed above the Sequence. The mode is depicted by a small icon in the container.

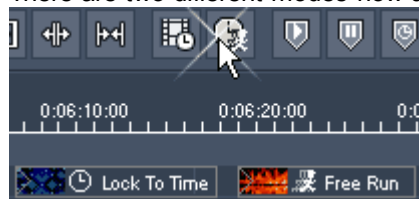

Per default, "Lock To Time" is enabled. The clip icon is a clock. In this mode, the clip synchronizes to the timeline. If the nowpointer is paused inside the container, the clip playback is also paused. If you have programmed [video playback keys](#)<sup>302</sup>, the sequence

playback overrides them.

If you uncheck the option, the container is in "Free-run" mode. The clip icon is a running-stick-figure. In this mode, the clip playback does not depend on the sequence playback mode. As soon as the nowpointer enters the container, its video playmode keys (play once, play loop, pause, stop) take effect.

#### Pre Roll time

If the Pre Roll time is 0, the media clip is loaded into RAM as soon as the nowpointer enters the container. The higher the resolution of the media is, or the more containers start at the same time, the longer the loading process takes. To display the media faster, Pandoras Box can start pre-loading it before the container actually starts. The Pre Roll Time defines the starting point ahead of the container. The Pre-Roll Time can overlap with a preceding container.

**In, Out**

When the nowpointer enters the clip, it will start/stop/loop at the given In- and Outpoint. These [Playback parameters](#)<sup>302</sup> can be adjusted in the Device Control tab or by entering the exact frame count in this Inspector. You can also enter a timecode value: enter e.g. 0:00:06:09 or just 609 to get the new time 0:00:06:09.

If you like to loop within the In- and Outpoint you can adjust the duration from the container easily: right-click on the container > "Set duration to Main Media In/Out"

Delete the values in the Inspector to get the original value.

Please note that in addition to the In- and Outpoint you can start with a later frame by using "Time in Clip" as explained above.

**5.2.3.14.13 PARAMETER KEYFRAME INSPECTOR**

The Parameter Keyframe Inspector allows you to set up the following:

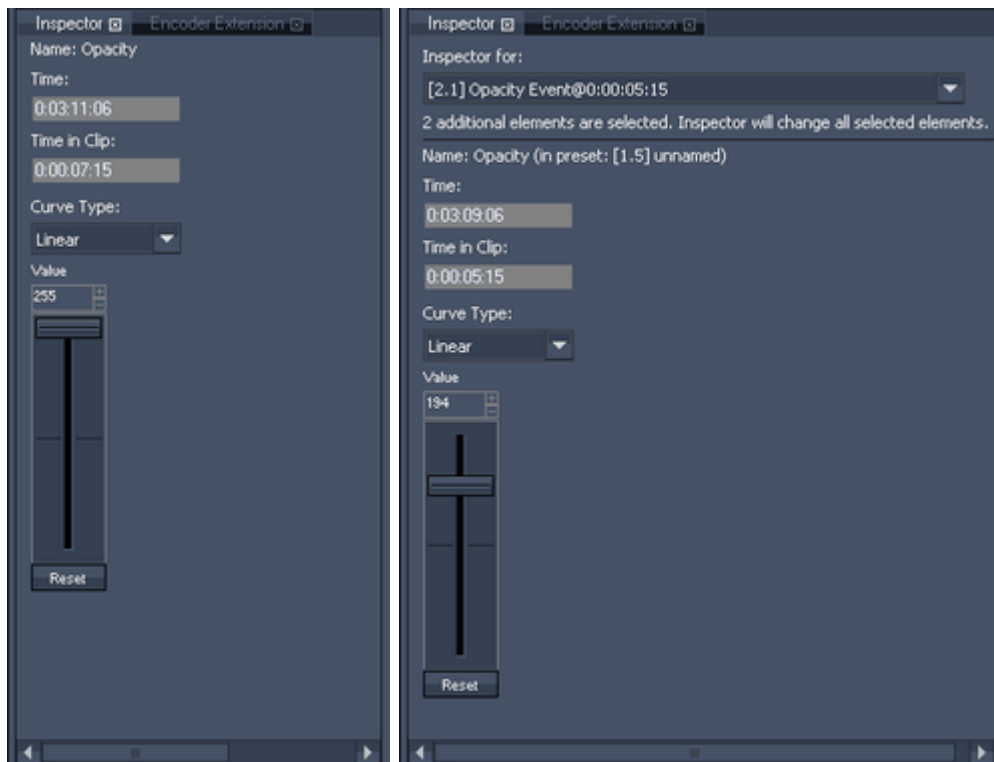

The left image shows the standard inspector for a keyframe.

The right image shows the multi-inspector of three keyframes that belong to a [preset](#)<sup>253</sup>.

Note the additional drop down menu where you can choose that keyframe the below information should refer to. The keyframe's name in the menu consists of:

[2.1] - the site and layer ID it belongs to,

Opacity Event - the parameter it belongs to, and

@0:00:00:05:15 - the time it belongs to.

Underneath the drop down menu you see the information that you have two more preset keyframes selected.

Under the horizontal line the standard inspector lists all customizable control and property settings.

- Name:

Informs you about the parameter's name the selected keyframe belongs to. In case the selected key belongs to a preset, the preset's ID and name are listed as well.

- Time:

To change the timecode of the key, enter the new timecode using the following syntax: enter eg. 0:00:06:09 or just 609 to get the new time 0:00:06:09.

To just add eg. two seconds to the current time, enter "++200", to subtract eg. two seconds, enter "--200".

- Time in Clip

To change the Time of the key inside the clip, enter the new time using the following syntax: enter eg. 0:00:06:09 or just 609 to get the new time 0:00:06:09.

To just add eg. two seconds to the current time, enter "++200", to subtract eg. two seconds, enter "--200".

- Curve Type: choose between Linear (Standard), Bezier, Bezier Corner, Constant and Stop. To edit the curves please open the [Curve Editor](#)<sup>161</sup>, here the different types are explained and illustrated.

- Value:

To change the key's value, enter the new value or move the fader.

### 5.2.3.14.14 CUE INSPECTOR

The Cue Inspector allows you to setup the following:

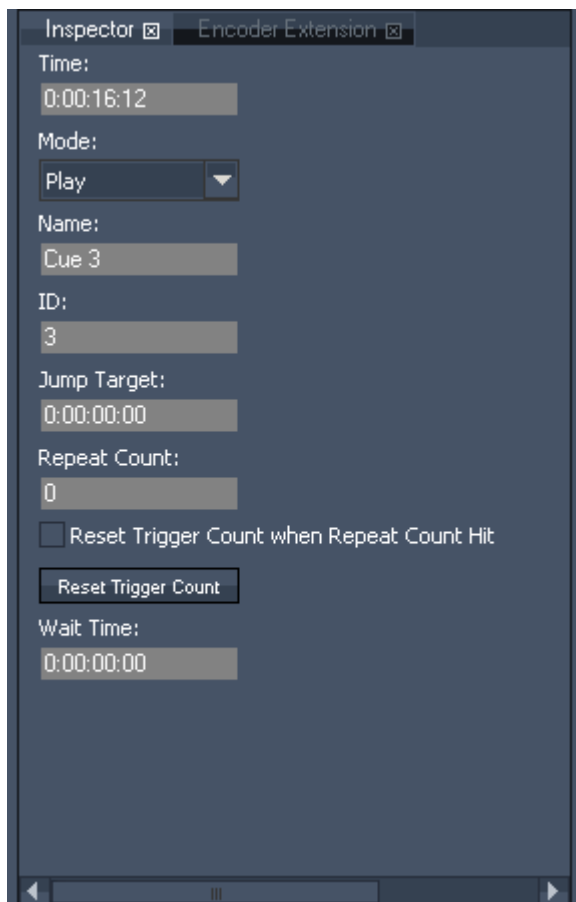

**[Time]:**

To change the timecode of the cue, enter the new timecode using the following syntax: enter e.g. 0:00:15:09 or just 1509 to get the new time 0:00:15:09.

To just add e.g. two seconds to the current time, enter "+200", to subtract e.g. two seconds, enter "--200".

**[Mode]:**

Available cue mode settings are:

- Play: the timeline play status will stay the same when reaching the Cue (Timeline is playing = it continues playing; Timeline is paused = it continues pausing)
- Pause: the timeline play status will change to "Pause" when reaching the Cue
- Stop: the timeline play status will change to "Stop" when reaching the Cue. This means that the nowpointer stops and then jumps to the timecode 0:00:00:00
- Jump: when reaching the Cue the nowpointer will jump to the Jump Target entered and the timeline keeps its previous play status
- Wait: the nowpointer will wait at the Cue for the Wait Time entered and then keeps on playing if it was in play mode before.

**[Name]:**

By default the cue is named with its Cue ID as shown in the tool tip on top of a cue. A new cue name may be entered here.

**[ID]:**

The numeric cue ID is increased for each new cue by default, this function may be deactivated in [configuration tab](#)<sup>139</sup>. To change a cue ID enter a new one here.

**[Jump Target]:**

Enter here the jump target timecode if cue mode is set to "Jump", using the following syntax: enter e.g. 0:00:15:09 or just 1509 to get the new time 0:00:15:09.

To just add e.g. two seconds to the current time, enter "+200", to subtract e.g. two seconds, enter "--200".

**[Repeat Count]:**

Enter here the amount of iterations if cue mode is set to "Jump", 0=endless loop. If repeat count is set to a number >=0, the jump cue will be executed this amount of times and then will be ignored to infinity. The amount of remaining repeats are displayed in front of the Cue Name. When the timeline is stopped (not paused) the repeat count will always be reset to the value entered here. To reset the Trigger Count automatically after the last repeat, please check the option [Reset Trigger Count when Repeat Count Hit].

**[Reset Trigger Count when Repeat Count Hit]:**

When this option is checked, the Trigger Count for the Jump Repeat will be reset automatically after the last repeat.

**[Reset Trigger Count]:**

By pressing this button the Trigger Count will be reset manually to the value entered as Repeat Count.

**[Wait Time]:**

Enter here the time the nowpointer should wait on this cue before continuing to play. The remaining wait time is displayed and highlighted in orange in the devices tab below the play, stop and pause buttons.

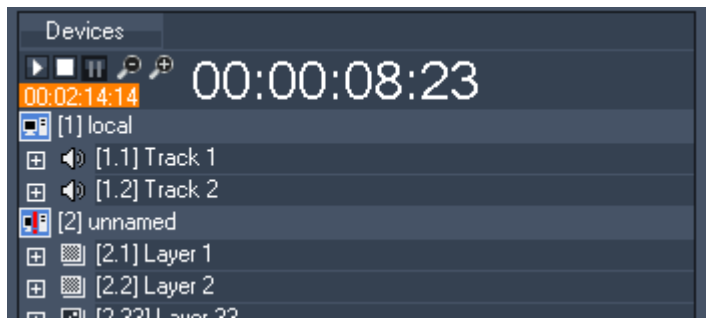

Please note:

It is recommended to leave 10 frames between two cues!

### 5.2.3.14.15 DEVICE INSPECTOR

The Device Inspector opens when a site (node) is selected in the [Device Tree tab](#)<sup>168</sup>.

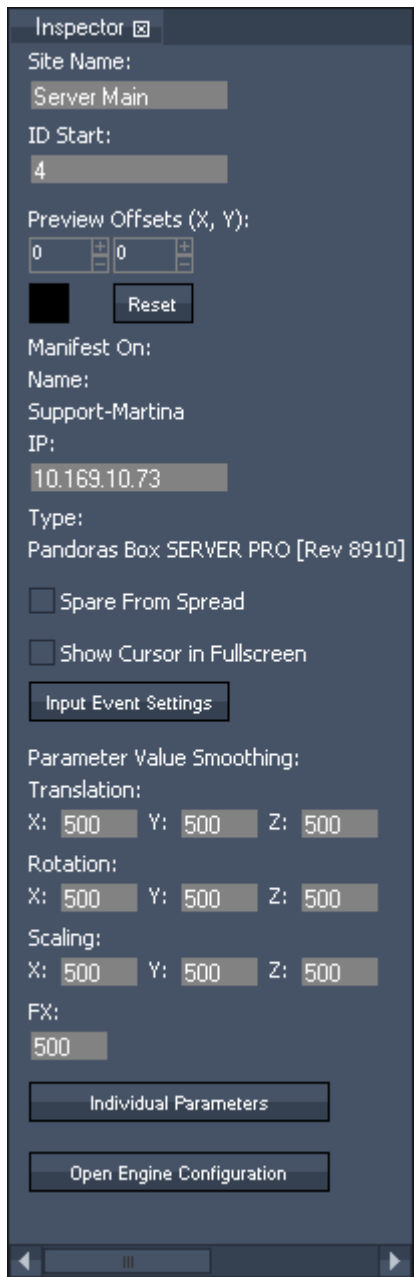

[Site Name]  
Change site/node name here

[ID Start]  
Set up the numeric start ID

[Preview Offset]  
Setting up the [Preview](#)<sup>232</sup> Offsets: apply an X and Y offset for the global cam by typing in the value or by clicking in the black box and moving the mouse cursor up and down. Press the Reset button to set the Preview Offsets back to default.

[IP]  
Edit the device IP address this site should refer to

[Spare from Spread]  
Disables content to be spread to this device.

[Show Cursor in Fullscreen]  
Enables to see the mouse cursor in the client's fullscreen window. This is useful when working with [Layer Picking in the Preview](#)<sup>244</sup> or with clients. Instead of this option you may as well use a [Pointer Layer](#)<sup>581</sup>, giving you more options to influence the look of the mouse cursor.

[Input Events Settings]  
The pop-up dialog offers settings regarding the feature "Layer Picking". In short, you can route input events like a mouse click to Pandora's Box' layers, for example to execute links in a [Browser Asset](#)<sup>248</sup>.  
The first option "Show Cursor in Fullscreen" conforms with the above described option.  
If you like to use Layer Picking on an output (instead of only in the preview tab and the Global Cam), the left setting "Enable device" must be activated, either for Output 1 or 2 or both.  
The settings to the right routes the Layer Picking data to either a [Widget Designer Device](#)<sup>609</sup> and, or to the layers.  
For more detailed information and a step-by-step example, please refer to the chapter about [Layer Picking](#)<sup>244</sup>.

To see the Input Event Settings for all systems in the Device Tree combined in one dialog, right-click in the Preview tab and choose "Show Input Events" there.

[Parameter Value Smoothing]  
Edit the settings for Translation, Rotation, Scaling and Effect Smoothing. Default is 500, the value range goes from 0 - 65535 (min to max). It defines the time in milliseconds the object will need to reach the given parameter value.  
These settings only have an effect for all incoming data, like from the fader of the device control, DMX, data from the Widget Designer, Art-Net etc. The timeline behavior will not be influenced by these settings.  
The button "Individual Parameters" opens a dialog where you can set the smoothing time for almost every parameter separately for each layer.

The button "Open Engine Configuration" gives access to hardware related engine settings especially influencing rendering performance. Please refer to the chapter [Configuration tab > Render Engine](#)<sup>153</sup>.

### 5.2.3.14.16 VIDEO AND GRAPHIC LAYER INSPECTOR

The Layer Inspector allows you to set up the following:

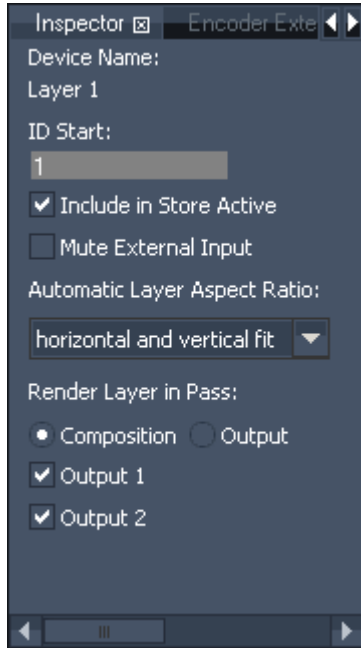

[ID Start]  
Numeric start ID

[Include in Store Active]  
Uncheck this option to exclude the layer from the Store Active command.

[Mute External Input]  
Tick this check box to block this layer from any external input, like Art-Net, Input Data from Widget Designer etc.

[Layer Sizing Mode]:  
Choose from the drop-down list how each layer should handle the aspect ratio of the media files loaded into it. By default the Layer Aspect Ratio is set to "horizontal and vertical fit". Examples are depicted below.  
horizontal and vertical fit: the media file will be shown in its original aspect ratio. Regardless whether the file is upright or crosswise, all parts of the media file will be shown, see figure B.  
horizontal fit: the media file will be shown in its original aspect ratio. It will fit horizontally into the layer, see figure C.  
vertical fit: the media file will be shown in its original aspect ratio. It will fit vertically into the layer, see figure D.  
fixed ratio: choose between the ratios 5:4; 4:3; 16:10; 16:9; 1.85:1. The media file will be stretched into the defined aspect ratio when loaded, see figure E.

Media Pixel Size: this is a dynamic mode that depends on the translation factor set up in the [Configuration tab > Unit Management](#)<sup>149</sup>. For example, if you have an output with a width resolution of 1920px (and a height resolution of 1080px) the according translation factor is 8.333. Now, the Layer Sizing Mode is based on 8.333 as well. If a 1920x1080px testpattern is assigned to a Layer, it will be displayed fullscreen. A 1024x768px texture will be displayed with a border of 1920-1024=896 and 1080-768=312. In case the Layers of a second client with a 1024x768px output are set to "Media Pixel Size" as well, the same texture is fullscreen whilst the first testpattern would be cut off.

[Render Layer in Pass]

The radio buttons "Composition" and "Output" toggle the layer between Pandoras Box' two render passes. Per default, the layer is included in the composition pass - it will be part of the so called render target and then be send through the entire output pass. It will be affected by its settings e.g. warp object, keystone or softedge etc. If the layer is only part of the output pass, it will not be seen by the camera as it is sent directly to the according output. In return it will not be affected by all the output settings and can be placed outside the warped / softedged area. This is especially interesting when working with multi-softedged projection(s) and [blacklevel compensation](#)<sup>613</sup> is needed. Find more information in the topic [V5 Video Processing Pipeline](#)<sup>297</sup>.



The check boxes "Output..." depend on the number of cameras / outputs. A Dual Server has two cameras, for example, and you may decide whether a layer should be only rendered by one of them. A possible application is working with different outputs for a key & fill scenario.

Examples for different aspect ratios:



Figure A: this is the original media file.

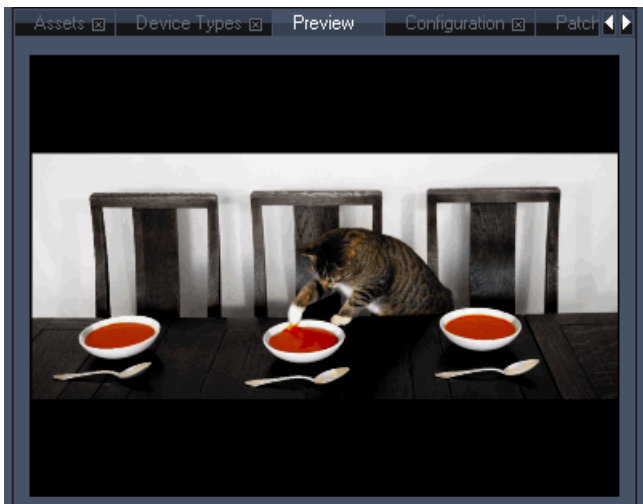

Figure B: Layer Aspect Ratio is set to "Horizontal and Vertical Fit". Regardless whether the file is upright or crosswise, all parts of the file will always be shown in its original aspect ratio.

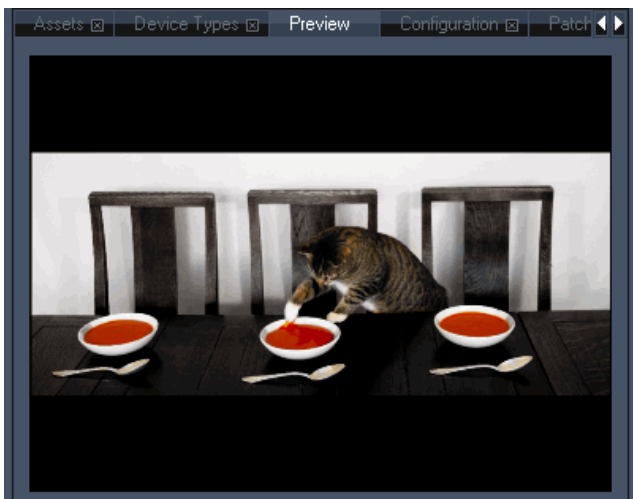

Figure C: Layer Aspect Ratio is set to "Horizontal Fit", the files aspect ratio is kept and it fits horizontally into the layer.



Figure D: Layer Aspect Ratio is set to "Vertical Fit", the files aspect ratio is kept and it fits vertically into the layer.



Figure E: Layer Aspect Ratio is set to "4:3" and the image is stretched to this aspect ratio.

### 5.2.3.14.17 POINTER INSPECTOR

The Pointer Inspector opens when a [Pointer Layer](#)<sup>581</sup> (used for [Layer Picking](#)<sup>244</sup>) is selected in the [Device Tree tab](#)<sup>168</sup>.

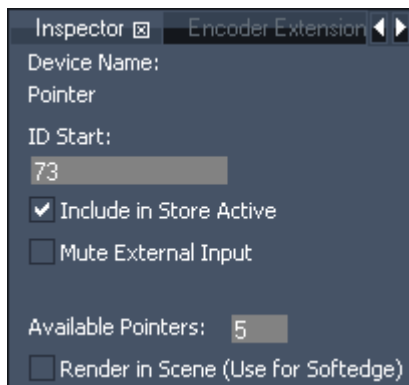

- [ID Start]  
Numeric start ID
- [Include in Store Active]  
Uncheck this option to exclude the layer from the Store Active command.
- [Mute External Input]  
Tick this check box to block this layer from any external input, like Art-Net, Input Data from Widget Designer etc.
- [Available Pointers]  
Choose how many inputs should be substituted with the Pointer

Layer. If you are working with an Windows XP system only one input is possible, whereas Windows 7 is able to work with multi-touch events.

[Render in Scene (Use for Softedge)]

Per default, the Pointer Layer is not included in the Composition pass. Hence, it is not part of the so called render target and not influenced by any Output settings, like warp object, keystone or softedge etc. Find more information in the topic [V5 Video Processing Pipeline](#)<sup>297</sup>.

### 5.2.3.14.18 LIGHT LAYER INSPECTOR

The Light Layer Inspector allows you to set up the following:

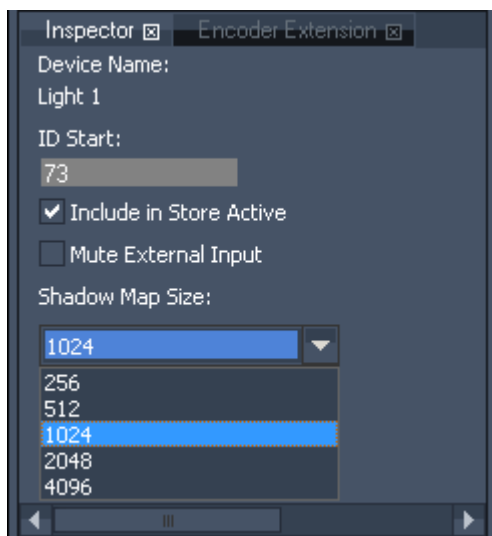

[ID Start]

Numeric start ID

[Include in Store Active]

Uncheck this option to exclude the layer from the Store Active command.

[Mute External Input]

Tick this check box to block this layer from any external input, like Art-Net, Input Data from Widget Designer etc.

[Shadow Map Size]

Choose from the drop down list how high the resolution from the light texture should be. By default the Shadow Map Size is set to 1024\*1024 px.

The example below shows the difference between 256 - 512 - 1024 - 2048 - 4096. Keep in mind that a higher resolution uses more performance.

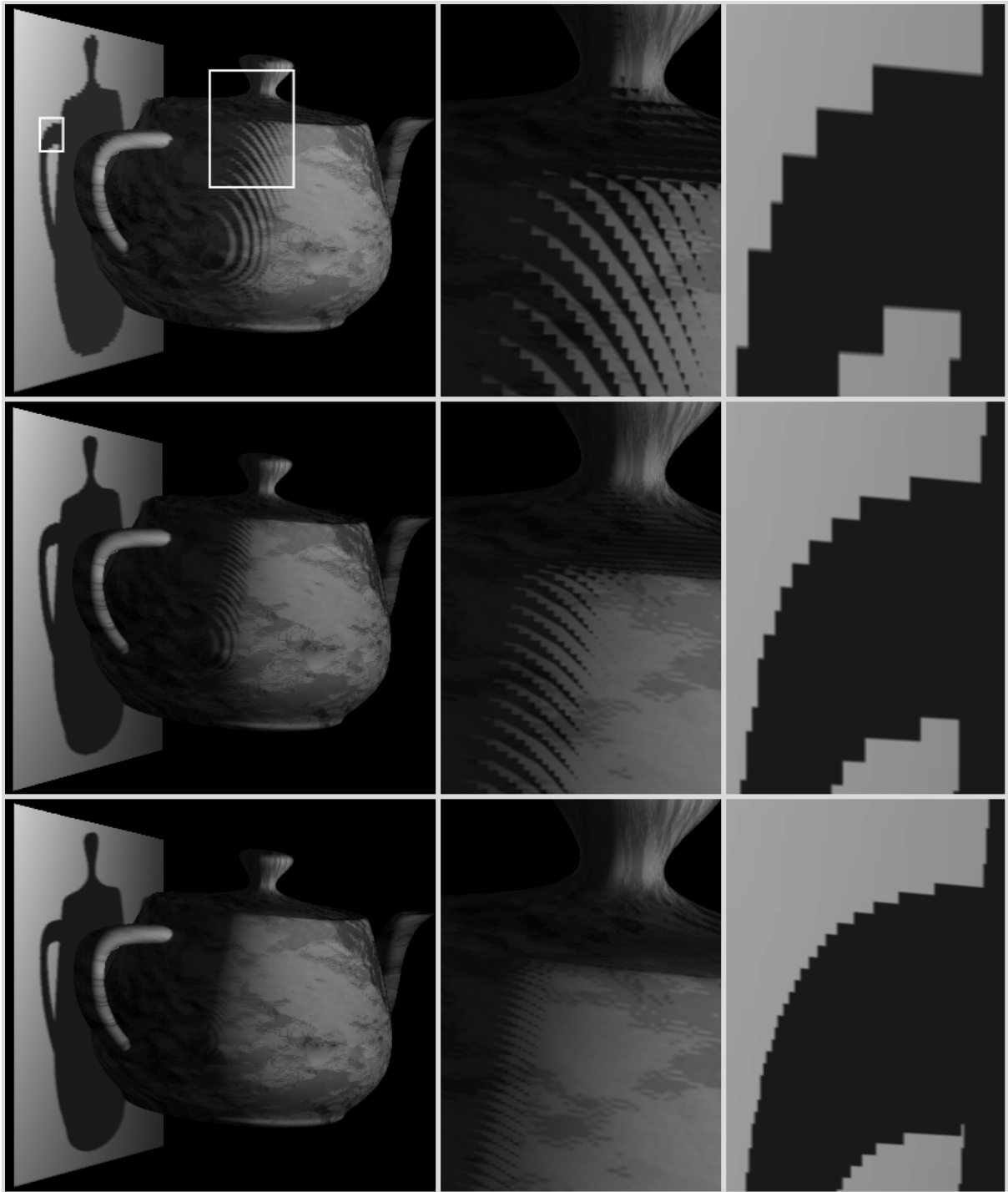

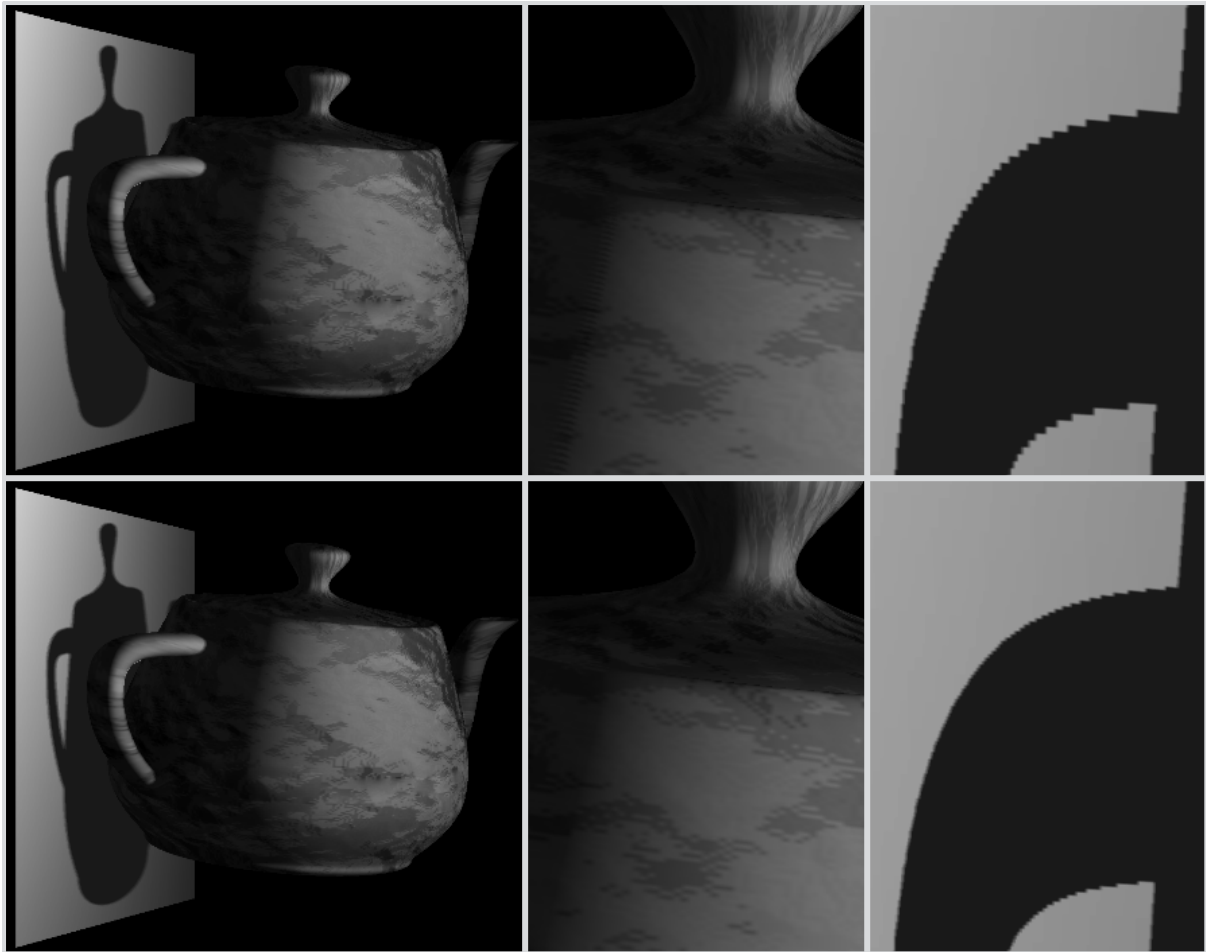

**5.2.3.14.19 TRACK INSPECTOR**

The [Track](#)<sup>578</sup> Inspector on the Manager allows you to set up the following:

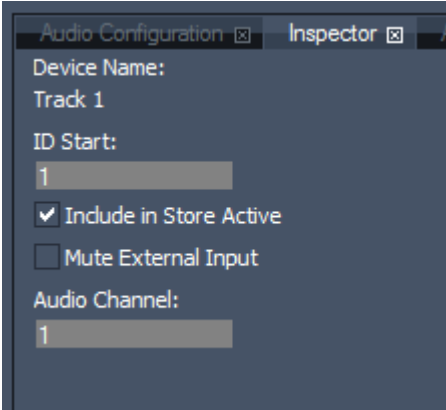

- Set up the Numeric Start ID
- Include in Store Active: uncheck this option to exclude the track in the Store Active command
- Mute External Input:  
Tick this check box to block the track from any external input like Art-Net, Input Data from Widget Designer etc.

- Audio Channel:

Choose the channel of your ASIO sound card this track should be routed to. When adding an audio file to the track, the first channel of the audio source will be routed to the sound card's audio channel you set up here (channel x). The second channel will be routed to the next sound card's channel (channel x +1) etc. Whether the sound file is mono or stereo, always at least two channels will be addressed. If you want to hear a mono source only on one channel, turn PAN to the left.

### 5.2.3.14.20 CAMERA INSPECTOR

The Camera Inspector allows you to set up the following:

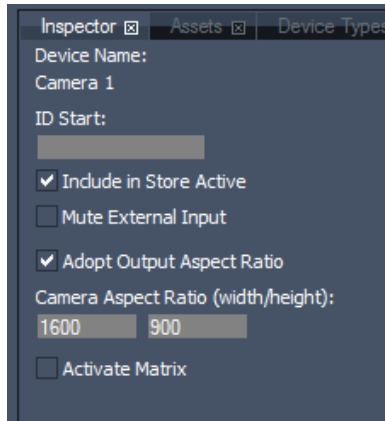

[ID Start]

Setup the numeric start ID of the camera device.

[Include in Store Active]

Uncheck this option to exclude the camera layer in the Store Active command

[Mute External Input]

Tick this check box to block the camera from any external input like Art-Net, Input Data from Widget Designer etc.

[Adopt Output Aspect Ratio]

Uses the aspect ratio of the site's graphics card output as aspect ratio for the internal camera.

The Output Aspect Ratio will be read out of the site's graphics card and transferred when connected to the master device.

If this read-out is not correct, you may:

- overwrite the read-out data in the site inspector. This will change all camera and output devices of this site to the new resolution after next start-up.
- overwrite single camera / output devices by removing the tick from the check box "Adopt Output Aspect Ratio" and enter a new aspect ratio.

[Enable Activate Matrix]

This output will additionally be played out as matrix via Art-Net (only for camera 1).

### 5.2.3.14.21 OUTPUT INSPECTOR

The Output Inspector allows you to set up the following:

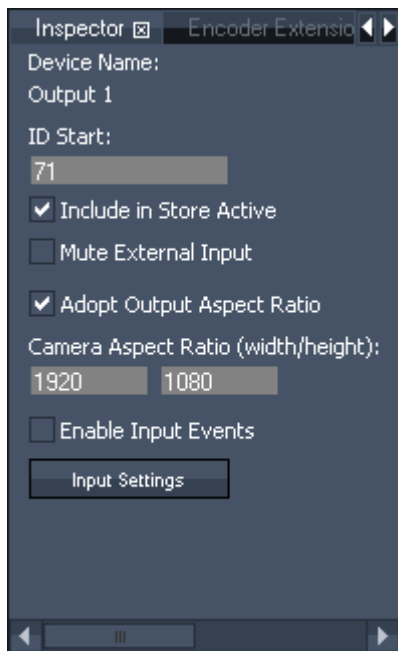

**[ID Start]**

Setup the numeric start ID of the output device.

**[Include in Store Active]**

Uncheck this option to exclude the output layer in the Store Active command

**[Mute External Input]**

Tick this check box to block the output device from any external input like Art-Net, Input Data from Widget Designer etc.

**[Adopt Output Aspect Ratio]**

Uses the aspect ratio of the site's graphics card output as aspect ratio for the internal output device.

The Output Aspect Ratio will be read out of the site's graphics card and transferred when connected to the master device.

If this read-out is not correct, you may:

- overwrite the read-out data in the site inspector. This will change all camera and output devices of this site to the new resolution after next start-up.

- overwrite single camera / output devices by removing the tick from the check box "Adopt Output Aspect Ratio" and enter a new aspect ratio.

**[Enable Input Events]**

Tick the check box if you like to use the feature [Layer Picking](#)<sup>244</sup>.

**[Input Settings]**

Choose whether you like to see the mouse cursor in the client's fullscreen window and how / where [Layer Picking](#)<sup>244</sup> should work.

### 5.2.3.15 MEDIA ENCRYPTION

Pandoras Box Media Encryption is a technology that encrypts media in order to protect content from being played back by unauthorized persons or systems without permission.

#### ENCRYPTION

With a

- PB Manager,
- Editor or the
- Server EDU version

you can now choose to [encrypt](#)<sup>[218]</sup> media by generating two ASCII strings inside the Pandoras Box (PB) interface. The Media Encryption is based on AES 256-bit technology similar to the DCI Digital Cinema Standard, which means you will get the same powerful level of encryption that most governments use for secret documents.

Currently, \*.mpg (including \*.mxi, \*.m2v, ...) and \*.wav files are supported. Encrypted media obtains the ending .mpx or .wax.

#### DECRYPTION

Any Pandoras Box system is able to decrypt the media with the correct ASCII strings while playing it back:

- PB Manager,
- any PB Player and Server (stand alone or client mode)

The content gets decrypted on the fly when being played back on the timeline or as an active value. There is no decryption period beforehand, thus there is no decrypted version of the content on your hard drive. Each frame needs to be decrypted (except the thumbnail). Only PB systems are able to understand the ASCII string and decrypt the media !

Of course encrypted content cannot be exported using the [Video Export](#)<sup>[281]</sup> feature. In return it is possible to encrypt an exported video itself.

#### POLICIES, KEYS AND MEDIA DONGLES

The encryption is based on two different ASCII strings - the key string and the policy string. At all times, the end customer needs both to decrypt media.

The key itself encrypts the content. The media "remembers" which key can unlock it. If you encrypt the same content with two different keys you will get two different encrypted files.

The policy holds meta information regarding the validity of a key. A key without meta information cannot be used, in return, meta information without the key is useless as well. Currently the only meta information is the time stamp, you can either decide to have no time restriction or to create a string that can only validate the key for a certain time.

As described [later on](#)<sup>[222]</sup>, it is possible to modify a policy, e.g. if you need to extend the validity. That means that the customer keeps the same encrypted media file and the same key, only the policy will be updated.



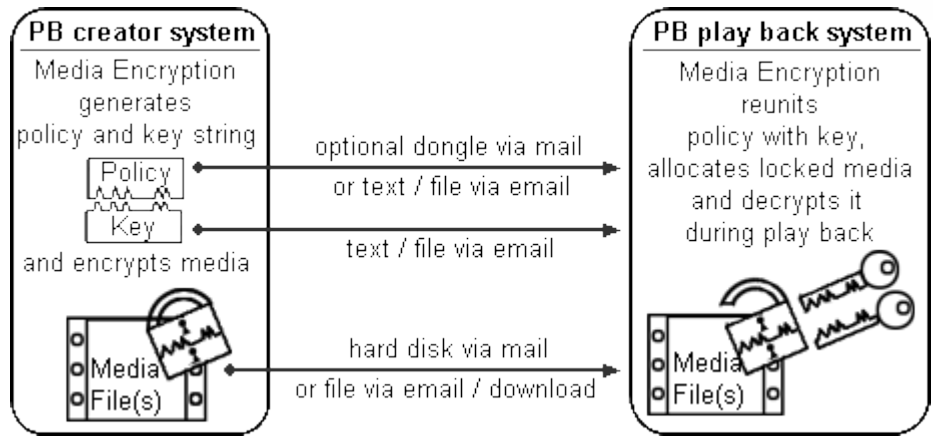

In case of a time-based encryption, you can save and transfer the policy as a "digital policy" or as a "dongle policy" meaning that it is written onto a Media Dongle. A Media Dongle may be purchased as any other coolux product, please contact your local dealer.

Working with a Media Dongle will give you the safest encryption solution possible. The Media Dongle holds the definite time reference itself and does not refer to the system time. The Media Dongle is more secure in other terms as well. As seen in the image above, you can transfer the strings (key string and policy string) in different ways to the customer, including the possibility to send both via email. In that case you have no chance to control whether he sends them to somebody else as well. If you choose to export the policy to a Media Dongle and send it via mail, the customer needs to have that special hardware. You have created the necessity of a physical key which cannot be copied.

**Example:**

It is possible to create content, encrypt it once with a key and create two different policies, both being allocated to the same key. Let's say the unlimited policy is written onto a Media Dongle and a time-based policy is a more simple "digital policy". You will then have one encrypted file, one key string but two policy strings.

You may then send one media file, one key and one Media Dongle to the show operator. He will be only able to play the content on a PB system if the Media Dongle is inserted. The other media file, key and (time-based) digital policy goes to the customers in the event agency. They will be only able to play the content on a PB system within a given time limit. They may as well send the key and policy to another person.

Of course you can encrypt as many files as you wish with the same key. In this scenario it has the following advantage: Now, as soon as the agency or the operator want some changes to be done, you can encrypt new content with the key and send only the media files to the two parties, both being in possession of the key and being restricted to their policy version.

Please note that currently only one Media Dongle per system is read and each dongle can hold only one policy. Likewise only one digital policy can be assigned to each PB system. As a result, one dongle policy plus one digital policy can validate two keys per PB system.

In the future it might be possible to create meta information such as a fixed MAC addresses etc. If you want to contribute your feedback to this new feature please contact [support@coolux.de](mailto:support@coolux.de).

The difference between a creator key / policy and an user key / policy is described in the [following chapter](#)<sup>218</sup>.

**Media Dongle hardware specifications:**

- Battery Life Warranty: 4 Years
  - Real Time Clock Accuracy (@ 25°C +/- 5°C) < 12.8 minutes/year
- Consequentially, we recommend to factor 13 minutes per year into your time limits.

### 5.2.3.15.1 ENCRYPTING MEDIA

To open the Media Encryption Tab, please click on 'Tabs' in the Toolbar - Media Encryption.

The screenshot shows the Media Encryption interface with the following sections:

- Media Encryption:** A dropdown menu showing 'key for company A [Creator Key]'. Below it are buttons for 'Create Key', 'Remove Key', 'Rename Key', 'Export Key', and 'Import Key'.
- File List Table:**

Status	%	File
encrypted	100	c:\coolux\content\content Pandora\MediaGobos 00001-00100\0001.mpx
encrypted	100	c:\coolux\content\content Pandora\MediaGobos 00001-00100\0002.mpx
unencrypted	0	c:\coolux\content\content Pandora\MediaGobos 00001-00100\0003.rm2v
- Actions:** 'Add Files', 'Remove Files', 'Encrypt', and 'Stop' buttons.
- Available Policies:** A dropdown menu showing 'policy for company A [Creator Policy]'. Below it are buttons for 'Create', 'Remove', 'Export', 'Import', and 'Edit'.
- Details:**
  - Key: key for company A
  - Policy valid until: Unlimited
  - Update (Content User): 'Request Update', 'Import Update' buttons.
  - Update (Content Creator): 'Load Request', 'Clear Request', 'Export Update' buttons.
  - Current Request: No Loaded Request
- Active Policies:**

Site	Digital	Dongle
[1] local	None	None
- Details:**
  - Change Digital Policy On Selected Sites: 'Assign', 'Remove' buttons.
  - Change Dongle Policy On Selected Sites: 'Assign', 'Clear' buttons.

In order to encrypt media files please follow these steps:

- Key:** Click „Create Key“ in the Media Encryption tab to generate a Creator Key .The appendix "[Creator Key]" is automatically added to the given name.
- Media:** Now choose the media files (mpeg or wav) which are part of your project and add them to the key via the „Add Files“ command. If you have chosen a file by mistake, select it and click "Remove Files".
- Encryption:** Select the command „Encrypt“ to start the actual encryption. The "status" and "%" row inform you whether the media is unencrypted, in progress or already encrypted with the chosen key. As a rule of thumb, two minutes fullHD footage take 10sec to be encrypted. Already encrypted files will not be encrypted again, there is no need to remove them from the list.

The encrypted files (mpx or wax) are saved in the same sub folder on your hard disk as the original files. Please note that another encryption with a second key will overwrite the first file when the original file was not moved to another folder.

The encrypted files are automatically added to the project and will be shown in the list as soon as you choose the used key via the drop down menu. The list helps you to keep an overview and to allocate the key if you have forgotten it.

You may choose whether you like to encrypt the files before even assigning the policy. This is because the key encrypts the media. The policy validates the key and has nothing to do with the media itself.

- Policy:** In order to setup the time limit, please choose „Create“. In the pop up dialog choose a Creator Key from the drop down list. This will join the policy and the key. Metaphorically speaking it imprints the necessary meta information on the key. Only then, the key is of value for the end customer. A policy will always remember the key it was allocated to at last.
- Time Limit:** Choose if you want to have an unlimited policy or a time-based encryption.

How does a time-based policy work on a Media Dongles?

After having chosen a time restriction including the day and time, the time difference to your local time will be added to the time reference on the Media Dongle, and later on from the dongle to the customer's time. This way the timeout is always calculated correctly even if the system's time has changed.

**Key Delivery:**

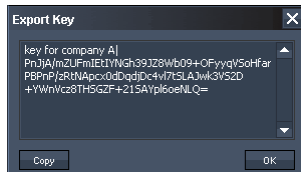

It doesn't matter which string you export first. For security reasons there is no text file generated automatically on your hard drive. Select the „Export Key“ button to generate the key string. Click the "Copy" button and insert the string to a file of your choice or into an email directly. The key is always transferred digitally.

**Policy Delivery:** The policy string can be transferred as a "digital policy" or as a [more secure](#)<sup>217</sup> "dongle policy":

To export the policy string and send it for example via email, select the "Export" button and copy the string.

To write the policy string onto a Media Dongle, scroll further down to the list with "Active Policies" and select the site the Media Dongle is attached to. Then click the button "Assign" at the very bottom of the tab where it says "Change Dongle Policy On Selected Sites". The list will update automatically and the column "Dongle" will show your policy. In case there was already an older policy string, it will be overwritten by the new data. The button "Clear" deletes the current policy from the dongle.

Now, you need to ship the Media Dongle to the customer and send the key via mail.

At any time you may rename the key and policy, this does not alter the functionality! The button "Edit" allows you to edit a policy before exporting it, you may either choose another Creator Key or time-limit.

If you have created a key it is saved within the project and the appendix "[Creator Key]" is automatically added to its name. After exporting a Creator Key it will lose this special status and will become a regular key.

What is special about a creator key? Only the „creator“ of a key can create a corresponding policy, exchange it with another policy or prolong the time limit if necessary.

As the creator of a key, you can always play the encrypted files – without a policy being required, even connected clients will play them back. A creator key can only exist within the original project, the key is saved as a part of it. The project has to be kept/stored in case more files should be encrypted with that particular key or in case a client demands content updates.

When exporting the key and importing it into a new project it will not be a creator key anymore. A regular key cannot be joined with another policy! The key will only be valid if the assigned policy is allocated and still active. This counts even when there are no specific limitations saved.

In general you can use any key in the system for encrypting media content, not just a creator key. Of course you are restricted to the originally assigned policy when choosing an imported key. Without the policy, no content can be played out.

Additional media files can be encrypted even later on using the same key as for the content before. As long as the customer is in possession of the key and the policy, he will be able to play out content that was encrypted at a later stage. In this case no update would be necessary.

Same distinction applies to policies. After creating a policy the appendix "[Creator Policy]" is added to its name. Only creator policies can be edited and load (creator) keys, in other words imprint the time stamp on them. After exporting a Creator Policy or writing it to a Media Dongle it will lose this special status and will become a regular policy. A regular policy cannot be edited at all, except of its name.

Please note: We strongly recommend to:

- use specified creator projects. If you want to use encrypted content yourself it is more secure to work with projects not containing the original creator key but the exported key.
- backup the creator projects to a separate place.
- keep encrypted content and the key and policy strings separate from each other.

It may be useful to create a data sheet to keep an overview which file was encrypted with which key +policy and to whom it was sent. In addition you may want to create a folder on your (external) hard drive where you copy the encrypted version to.

### 5.2.3.15.2 DECRYPTING MEDIA

To open the Media Encryption Tab, please click on 'Tabs' in the Toolbar - Media Encryption.

In order to decrypt content you have to copy the key, the policy and the content to the project. The order in which you go through these steps doesn't matter, since the files can be played only if all elements are present:

**Key:** Copy the string from the email or text file. Select „Import Key“ and click the "Paste" command. After clicking "OK" the key string is imported to the project and spread automatically to all connected clients and to all clients added to the project later on. You may rename the key (and policy) at any time, this does not alter the functionality!

**Policy:** If you have received a digital policy via email or an text file, import it in the same way by selecting the "Import" button. As policies are not spread automatically, you need to assign them to each PB system. To do so:

- choose the particular policy in the policy`s drop down list
- scroll further down to the list with "Active Policies" and (multi-)select the site(s) where you want the selected policy to be active
- click the button "Assign" at the very bottom of the tab where it says "Change Digital Policy On Selected Sites".

The list will update automatically and the column "Digital" will show the according policy. If you have assigned a wrong policy simply choose another one in the drop down menu and repeat the mentioned steps.

If you have received a dongle policy via one or more Media Dongles insert them to the PB systems which should be able to decrypt media. The dongle and its containing policy are recognized automatically. The column "Dongle" in the list with "Active Policies" will show the current status. As well the policy will be added to the drop down list "Available Policies" in the PB master (even though no dongle is attached there). The appendix [From Dongle] informs you that it is no regular digital policy.

Now, on each PB Master and PB Client the policy recognizes imported keys and validates the according one.

Please keep in mind that every system that has to decrypt media needs to have a valid key, that may require a Media Dongle per each system!

As soon as you would unplug a Media Dongle, assign a wrong digital policy, exceed the allowed time-limit or remove the key in the master, the system cannot decrypt any more and either the preview or the fullscreen window will show a dummy picture instantly. The dummy picture tells you whether there is an issue with the key or the policy status.

**Media:**

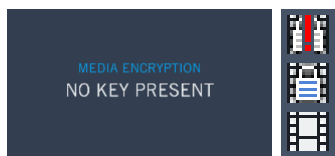

Now drag the encrypted content into the project. The content recognizes its key and can be unlocked. The files are automatically added to the particular key list. If it cannot find the correct key it will be substituted with a dummy picture.

The icons in the project tab tell you whether a file is

- a) encrypted with a key / policy that is not part of the project,
- b) encrypted with a known key / policy
- c) not encrypted.

The status does not affect the functionality of spreading. E.g. the Manager will spread encrypted content to all clients, even though it is not equipped with a dongle-based policy. Only those clients with the correct key and policy will actually decrypt the media.

We strongly recommend not to change keys or policies during a show! Any change in a key or policy status or Media Dongle connection will update all encrypted files.

### 5.2.3.15.3 UPDATING A POLICY

In case the key is allocated to a time-based policy it might be necessary to prolong it.

Client:



Choose the policy you wish to prolong. Click the command "Request Update". Copy the string and send it to the content creator. There is no need to send the Media Dongle!

If you are working with dongle-based policies, please note that the string created for the request holds not only information about the policy itself but also information about attached dongles. While creating the request string, please be sure that all clients are connected and all dongles are plugged in if they need to be updated. Otherwise a particular Media Dongle can not be updated later on without sending a new request string! This makes the entire encryption process more safe.

Creator:

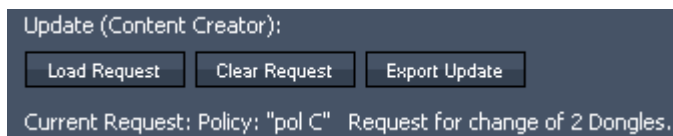

Open the project with the corresponding creator key and creator policy. Copy the string you received from the end customer. Click the

button "Load Request" and paste the string. The information line tells for how many Media Dongles the update will be valid and eases to keep an overview. Choose the policy the customer wishes to extend and click the button "Edit". After entering new limitations click the command "Export Update". Copy the string and send it to the customer. The button "Clear Request" simply discards the request information. Please note that you cannot export an update string without loading a request string. Your customer needs to generate that request string first hand.

Client:

This time you click the button "Import Update" and paste the update string you received from the content creator.

The policy status from all systems in the entire network is updating automatically. If one client is not online whilst updating it will receive the prolonged digital policy as soon he is connected to the master system.

In case you are working with dongle-based policies, the dongle data is automatically overwritten with the new policy. A pop up lets you know if all dongles (that were part of the original request) can be reached and updated. You may continue updating even though one Media Dongle is missing. As the update procedure can be executed repeatedly, simply import the update as soon as the dongle is available. Meanwhile the policy will not only be listed with the appendix "[From Dongle]" but also with "[Variant]" in order to inform you about different time limits within the network.

### 5.2.3.16 PATCH

The patch tab lets you assign an Art-Net and DMX input & output patch for individual devices.

Please note:

All Pandoras Box devices and sequences are patched to DMX input and all DMX devices are patched to DMX output.

The patch tab is context sensitive, please first open the patch tab and then choose a device to be patched from the device tree.

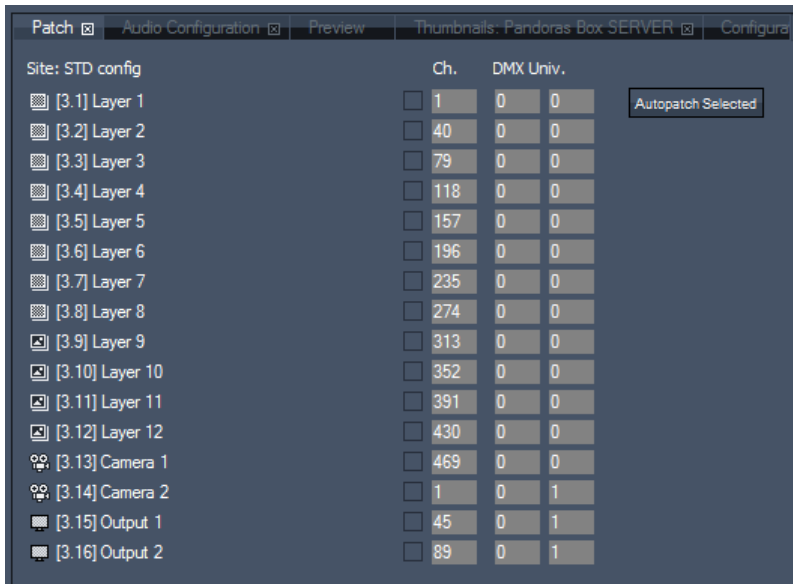

The patch is divided into the following section:

- [Site Patch](#)<sup>223</sup>
- [Sequence Patch](#)<sup>228</sup>
- [DMX Start Address](#)<sup>228</sup>

### 5.2.3.16.1 SITE PATCH

Within PB V5 there are two different patch configurations available:

- Standard Configuration and
- Lighting Console Configuration.

These two configuration types may be chosen when

- Creating a new project (see [File Menu](#)<sup>129</sup>)
- Adding a site via the [Device Types Tab](#)<sup>181</sup> into the project.

#### STANDARD CONFIGURATION

In the Standard Configuration there is no parameter patched by default, no FX are added to the layers. When no parameter of a layer is patched, there is just an empty check box in front of the DMX Channel, Subnet and Universe settings.

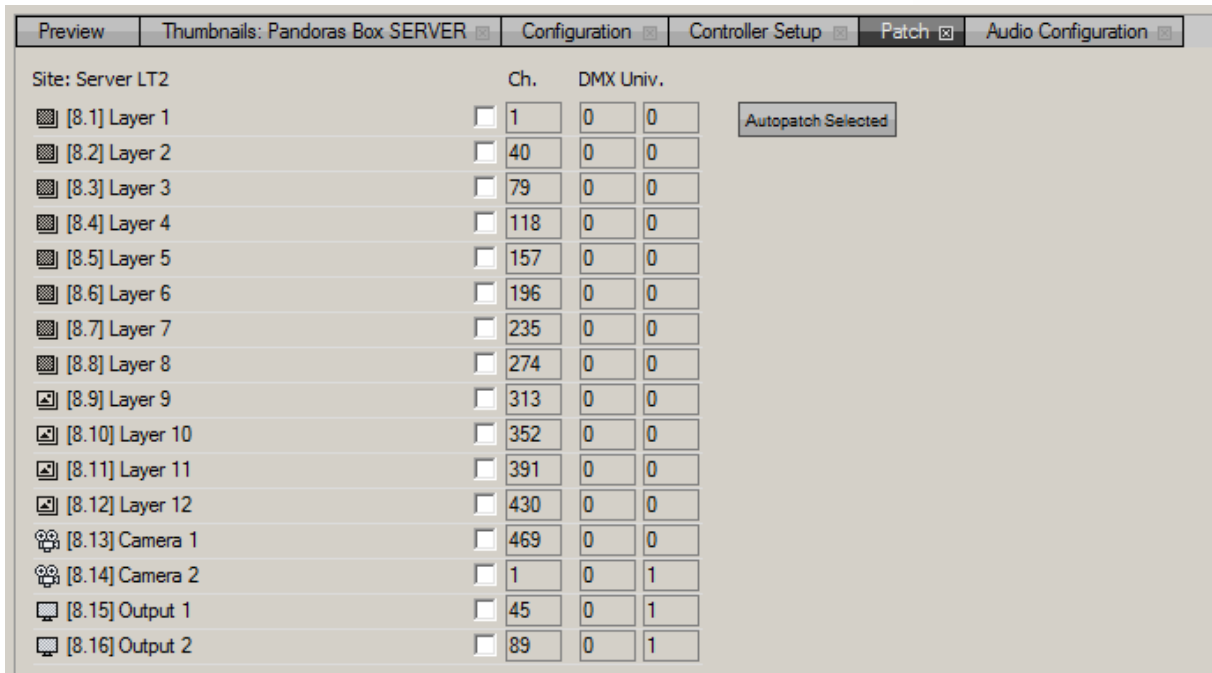

When double-clicking on a layer / device you will see the parameters / parameter sections belonging to this layer.

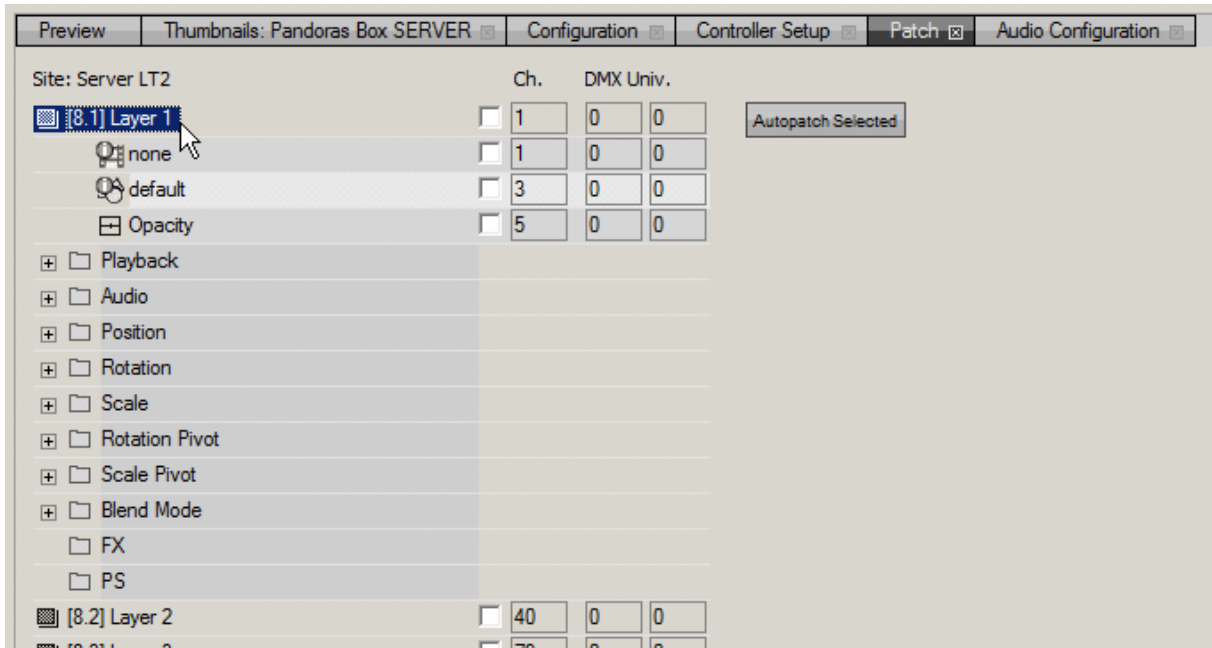

All parameters may now be patched manually by ticking the parameter’s check box and entering the DMX start address.

By pressing [Autopatch Selected] you may patch one or several whole layers / devices.

[Autopatch Selected]:

Select the layers/devices you want to patch. Do this with the Windows standard selection method:

To select several devices click on the first one so that it is highlighted in blue, hold [CTRL] pressed while selecting more devices one by one or hold [SHIFT] pressed and click on the last device to be selected.



Example:

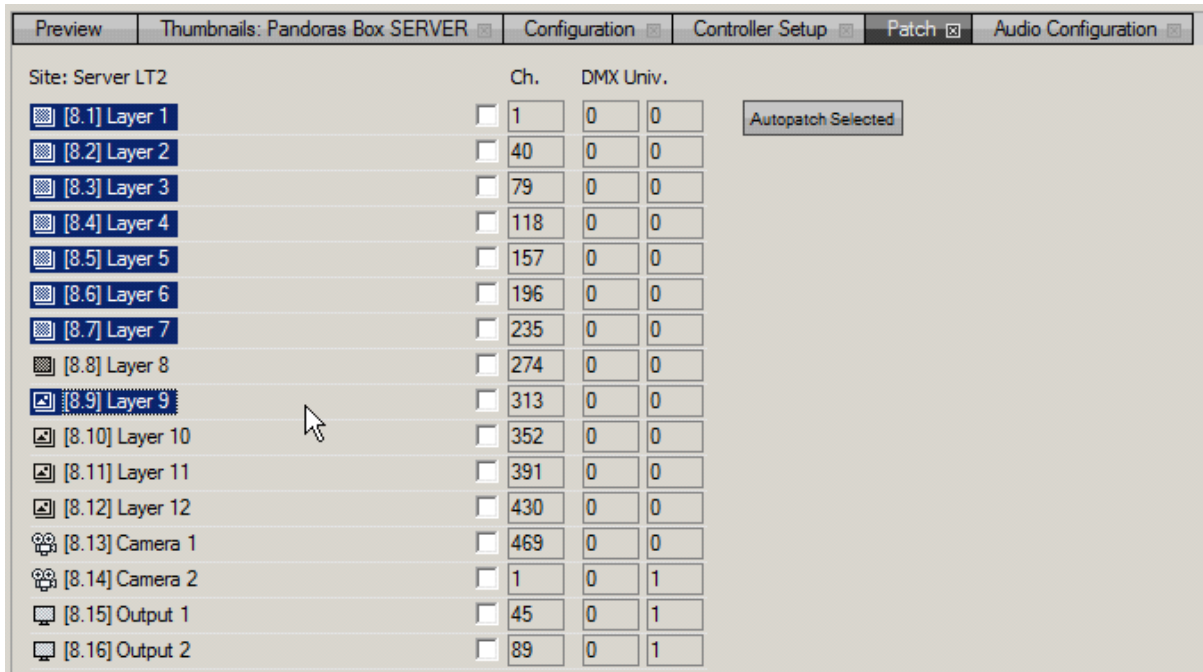

Press [Autopatch Selected]. A pop-up window appears.

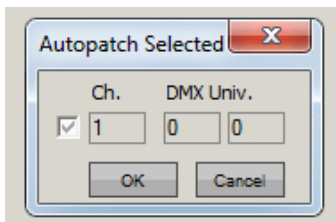

You may now tick the check box several times to activate different parameter activation settings:

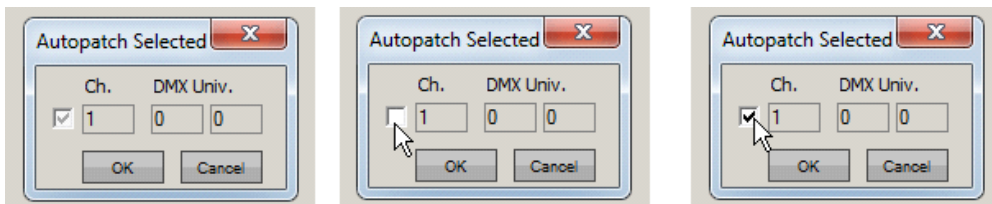

- = the current parameter selection will be kept
- = all parameters will be unpatched
- = all parameters will be patched.

The DMX start address that is set by default (starting with Ch. 1, Art-Net Subnet 0, Universe 0) may be changed by entering a different DMX start address. All devices selected will be patched according to the patch mode you set with the check box.

Going on with the example, the pop-up window is set to patch all parameters, beginning with the DMX start address: DMX Channel 1, Subnet 0 and Universe 4, see image below.

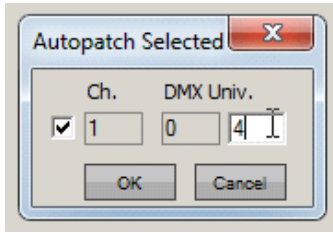

The patch tab now is patched like shown in the image below.

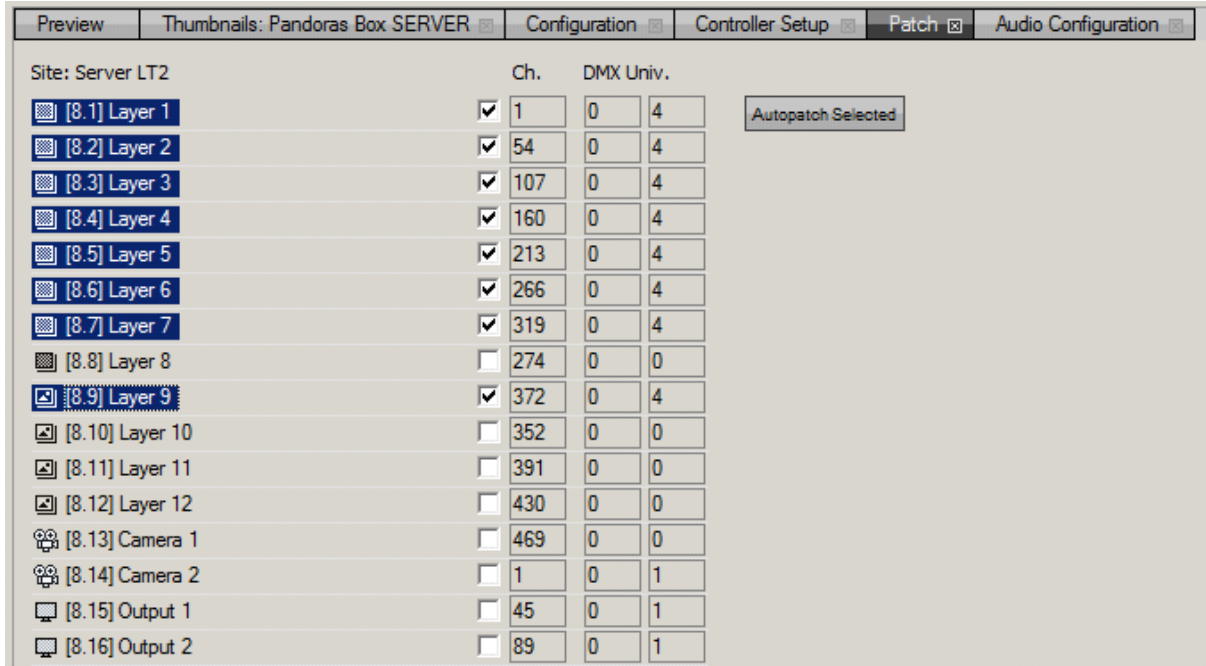

All selected layers are patched one after each other, according to the amount of parameters (see [DMX patch tables](#)<sup>623</sup>). When there were FX added to the layer before patching, the amount of parameters will be higher. When adding FX to a layer after the patch was done, these FX are not patched. This needs to be done manually.

### LIGHTING CONSOLE CONFIGURATION

In the Lighting Console Configuration there are specific parameters patched by default, see [DMX patch tables](#)<sup>623</sup>, others, like i.e. Scale Pivot are not patched.

Different to a site added in STD mode, the Video and Graphic layers of sites added Lighting Console Mode contain multi-effects by default.

The patch appears with check boxes that are ticked but grayed out. This means that there is a mix of patched and not patched parameters in this layer, see image below.

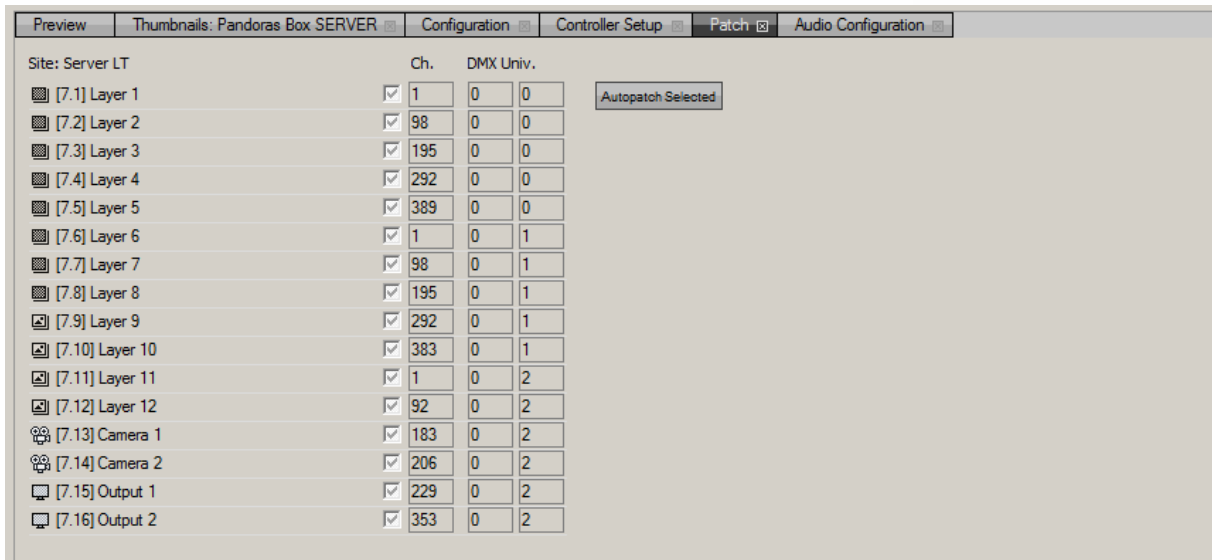

If expanded you will see that some parameters are patched, others not.

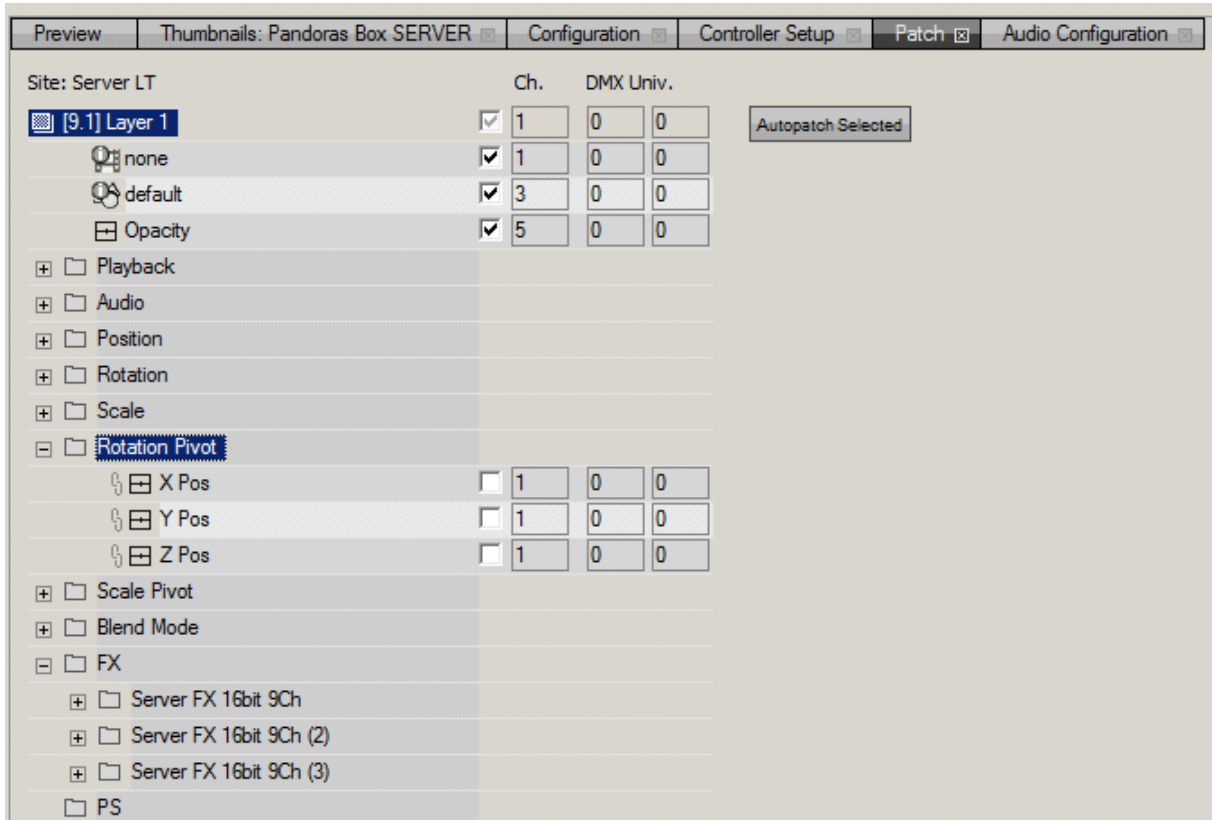

If you need additional parameters patched you may do it manually by entering a DMX start address and ticking the check boxes or use the autopatch function like described under "STANDARD CONFIGURATION".

### 5.2.3.16.2 SEQUENCE PATCH

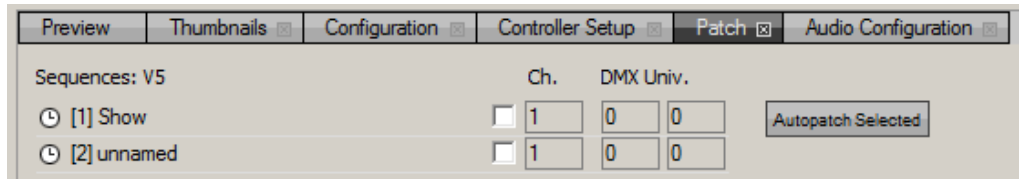

When selecting the sequence folder in the project tab, the patch tab shows all available sequences within the project.

The sequences may be patched just like the site patch is done.

See the [sequence DMX tables](#)<sup>623</sup>.

### 5.2.3.16.3 DMX START ADDRESS

See here some hints for the DMX start address.

- Channel:

Enter here the DMX start address for the device.

- DMX Universe

Enter here the DMX Universe address. As the Pandoras Box patch is related to Art-Net, you have to enter two numbers in the text fields.

Art-Net Patch: the first text field is the Art-Net Subnet, the second one the Art-Net ID / Universe.

MA-Net Patch has to be translated to Art-Net addressing.

Please see the following translation chart:

Grand MA Patch	Pandoras Box Patch	
Universe.Channel	Ch.	DMX Universe
1.1	1	0 : 0
2.1	1	0 : 1
3.1	1	0 : 2
15.1	1	0 : 14
16.1	1	0 : 15
17.1	1	1 : 0

### 5.2.3.17 PLAYLIST

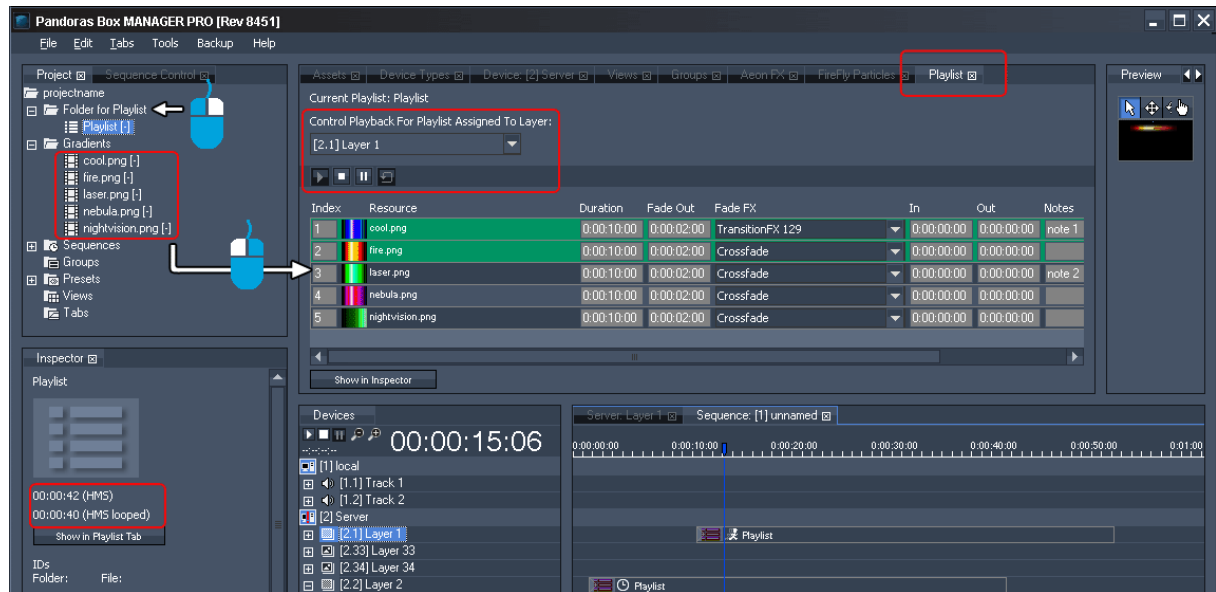

A Playlist offers the easy and fast possibility to play a certain number of media files in a row without the need of programming separate containers on the sequence.

#### Adding, deleting and reordering content in the Playlist

In the [Project tab's right-click menu](#)<sup>248</sup>, you may find the command to add a Playlist. In order to add media files to it, select the Playlist and look for the new [tab "Playlist"](#)<sup>229</sup> (next to the Particles tab). You may as well click the "Show in Playlist Tab" button in the Playlist Inspector.

Now you may drag and drop from the Project tab into the Playlist tab:

- images
- image sequences
- videos
- audio files

Each newly dragged resource will simply be added at the end of the list (even when the Playlist is already playing back). If you like to put the files in another order, (multi-)select an entry and drag it between to others or assign a different "Index" number. Deleting files is possible with the Delete key on your keyboard or by choosing the respective command in the right-click menu.

#### Duration and other settings in the Playlist

The duration of images is automatically set to 10 seconds; all other media keeps its real duration. You may change the duration, fade time and transition effect - again, multi selection applies the chosen setting for all selected items. Further to the right you find "In" and "Out" times that take effect on videos or audio files only and define the starting and ending frame. Notes for internal use can be added too.

The overall duration of all files minus the fade times result in the length of the Playlist. The fade times need to be subtracted as fading two files is obviously shorter than playing them back one after another. The duration is displayed in the [Playlist Inspector](#)<sup>196</sup>. It offers general settings like Folder and File ID, resolution or aspect mode.

#### Assigning a Playlist to a layer

As a last step, the Playlist needs to be assigned to a video layer. You may assign it as an active value or program it on the timeline as one single container. Please note, that you may assign the same Playlist to several video layers. Then the playback status can be different per layer, e.g. one layer can be

in pause mode showing the file with index 5, the other in play mode between index 10 and 11. The Playlist tab offers a drop-down menu containing all layers the Playlist has been assigned to. Depending on this drop-down menu, the Playlist changes and displays the layer's playback mode and the currently active index file with a green highlight. In the image above the chosen Playlist on Layer 1 is currently fading between two images.

Please note that not only during the cross-fade the Playlist consumes the memory for the current and the following content file, thus it needs the same performance as assigning the assets separately to two layers!

### 5.2.3.18 PRESET VIEW

The preset tab lets you create, edit, paste and apply presets in a browser view. To open a preset tab, navigate to Tabs - Presets and choose one of the preset banks to be shown in the tab. You may as well make a right-click on a preset type in the project tab and choose "Open Browser".

Please note that the preset feature itself is described in the [Preset](#)<sup>253</sup> chapter.

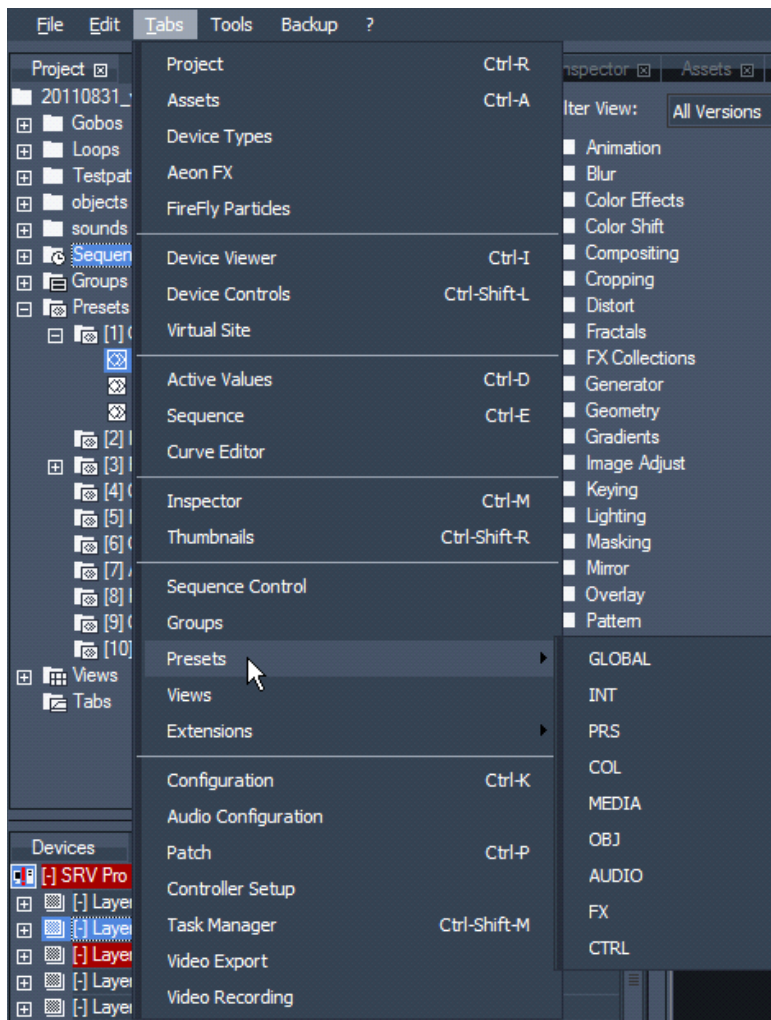

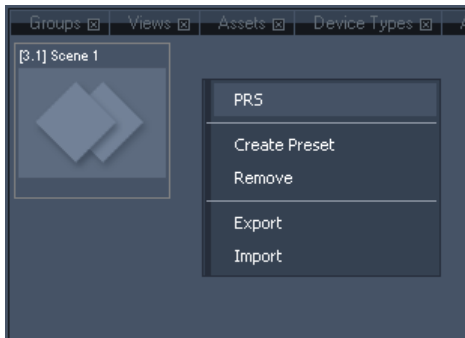

The context menu of the preset view provides the following options for creating and organizing presets:

**[Create Preset]**

Creates a snapshot preset by looking at the current active values and copying them as a preset key (at zero time) according to the current preset bank.

**[Remove]**

Deletes the entire preset bank and all including presets. A new preset bank can be created in the Project Tab

**[Export]**

Saves all including presets as an xml file.

**[Import]**

Adds the previously exported presets to the preset bank.

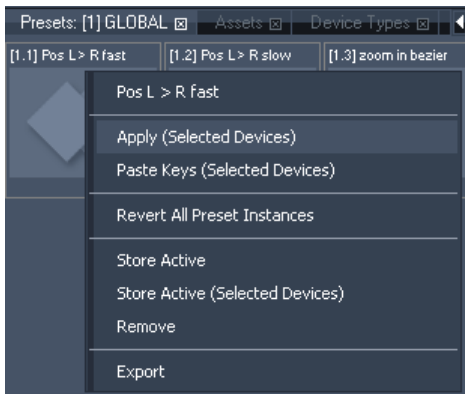

The context menu of the preset itself provides the same options for creating and organizing presets as in the project tab (except the rename function):

**[Apply (Selected Devices)]**

Applies a preset, starting at the first selected layer and activates those layer parameters that are stored inside the preset. The values are not inserted into the timeline.

**[Paste Keys (Selected Devices)]**

Creates a new instance from the preset by pasting its keys into the currently open sequence starting at the first selected layer.

**[Revert All Preset Instances]**

Discard the changes made in one or more instance and make them all comply with to the master preset again.

**[Store Active]**

Stores all active parameter values to the preset that are allowed to be stored in this preset type.

**[Store Active (Selected Devices)]**

Stores all active values of the selected devices to the preset.

**[Remove]**

Removes the preset.

**[Export]**

Saves all including presets as an xml file.

### 5.2.3.19 PREVIEW

The Preview tab allows you to switch between different preview modes (i.e. cameras). In the Global Camera Mode you are able to see all servers and other clients within the project at the same time in one preview window. In order to see what exactly is output by one output of a client's graphic card you can preview a specific output only. If working with Art-Net LED walls, you can toggle the patch on and off.

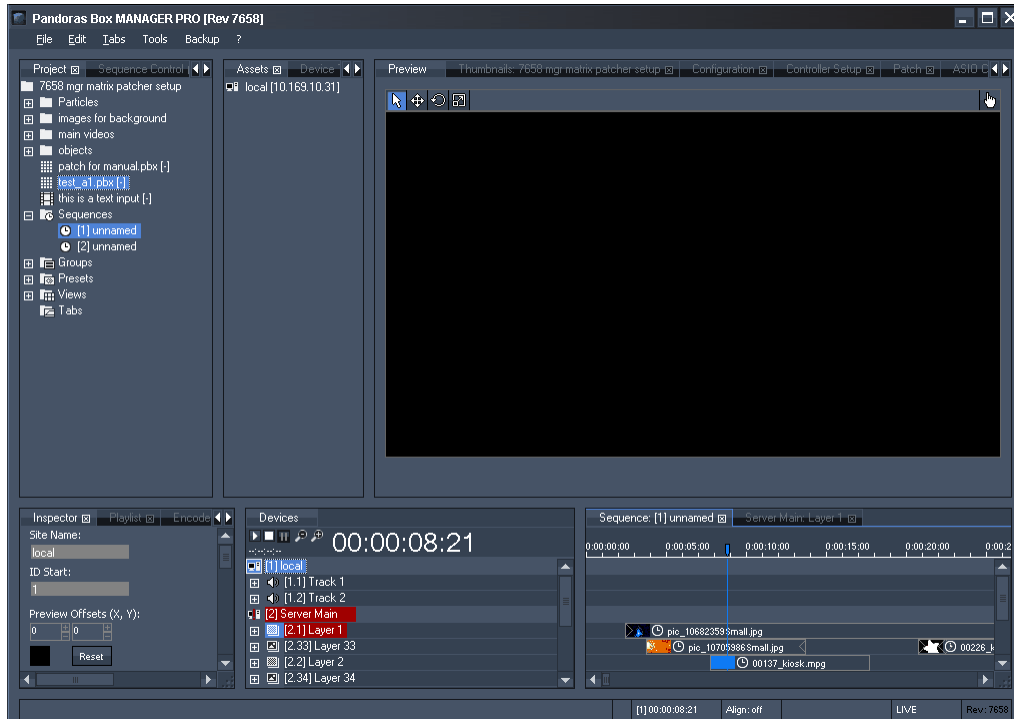

When opening a project the first time, the Preview tab will not show anything as seen in the screenshot left. This is because you first have to decide which client(s) in the tab "Devices" should actually be previewed, this is described in the [next chapter](#)<sup>233</sup>.

The image shows the interface from a manager software. If opening a Player / Server software as master the button **Full Screen** is added just below the Preview tab. This toggles the local device directly into fullscreen.

#### Important information about the preview

To be able to see all media files in the preview, the media files need to be loaded from the PB master's hard drive into the project.

The preview is rendered inside the user interface, based on the control data the PB master device sends out to the connected PB clients. Because of this the preview does not provide a real-time feedback of the PB clients outputs. This means for example that if a PB Client is not able to render any media file you won't see this issue in the preview tab.

On the other hand the preview allows you to pre-program a show without having real PB clients connected.

The next chapters:

- let you know how to [include site into the preview](#)<sup>233</sup>
- explain the different [preview modes](#)<sup>234</sup>
- describe how to [zoom, pan and rotate](#)<sup>237</sup> the preview
- explain what [wireframes and pivot handles](#)<sup>238</sup> are for



- inform how you can use the preview as an interactive interface with [pivot handles](#)<sup>239</sup> and [Layer Picking](#)<sup>244</sup>

### 5.2.3.19.1 INCLUDING SITES INTO THE PREVIEW

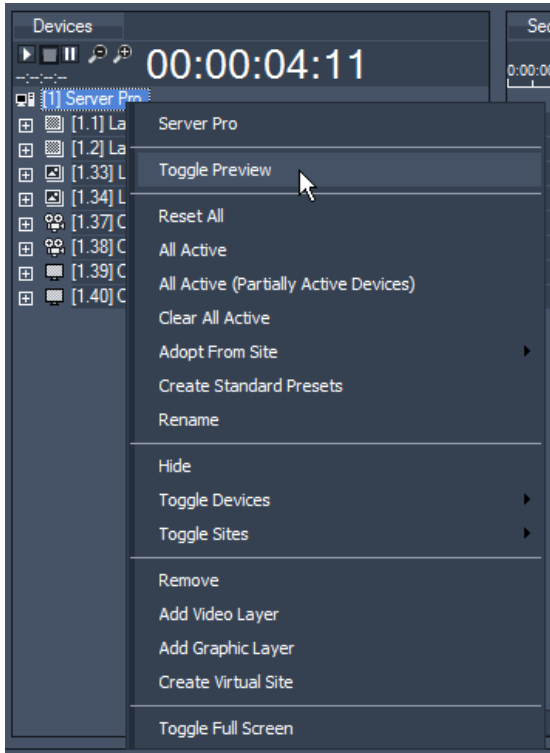

When adding sites to your project, none of these sites will be included to be previewed by default. To include a site to be previewed, right-click on the site and choose the context menu entry "Toggle Preview" as seen in the left image.

As soon as a site is included to be previewed the site icon in the device tree gets highlighted in blue.

Bottom left: Site 1 is not included to be previewed.  
Bottom right: Site 1 is included to be previewed, the site icon is highlighted in blue.

Please note: In order to see the client(s) in the preview, the Manager needs to render their files. It does not scale the content in any way! That means that the full content needs to be encoded and displayed. The more clients you add to the preview Tab / the more content files are playing / the higher the content's resolution or framerate is, the more performance is required on the Manager PC as well.

When including something into the preview, the default preview from a new project is

- the Global Camera Mode when using a PB Manager as master
- Output 1 when using a PB Server or Player as master

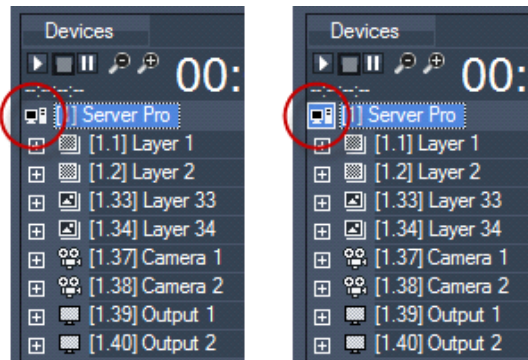

The next chapter describes the difference between these [preview modes](#)<sup>234</sup>...

### 5.2.3.19.2 SELECT PREVIEW: GLOBAL CAM OR OUTPUT

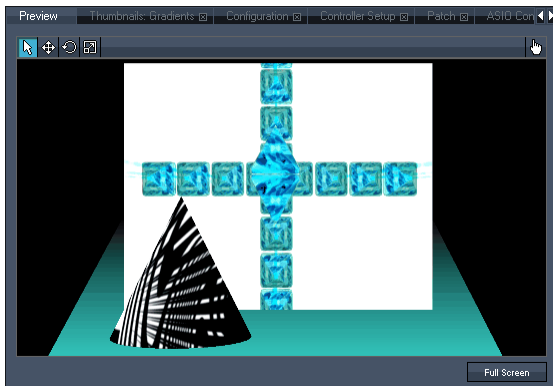

The preview can be set into two different modes:

You may see a single Output Device (as seen in the left image) depicting the image that is actually seen on the display attached to a graphic card's output.

The white wireframes you see within the preview tab mark the camera target of the previewed site. The aspect ratio of the wireframes represent the aspect ratio of the [camera device](#)<sup>[214]</sup>.

The wireframes and other tools within the Preview tab are explained one of the next chapters: [Preview handles and wireframes](#)<sup>[238]</sup>.

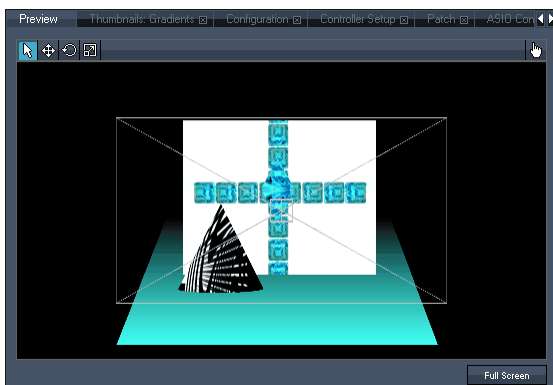

Or you may see the so called "Global Cam" (as in the left image). It allows previewing all included sites at once. Furthermore the whole 3D space is shown instead of only the specific area seen by the site's camera device.

Please note: Everything that is set up in the output device of this previewed site, i.e.. a warping object, softedge etc. will NOT be shown in the global cam preview! Please change to the output's preview if you want to see the output settings as well!

To change between the global cam and any output that is included in the preview, right-click inside the preview tab and choose "Select Preview" and then the desired device.

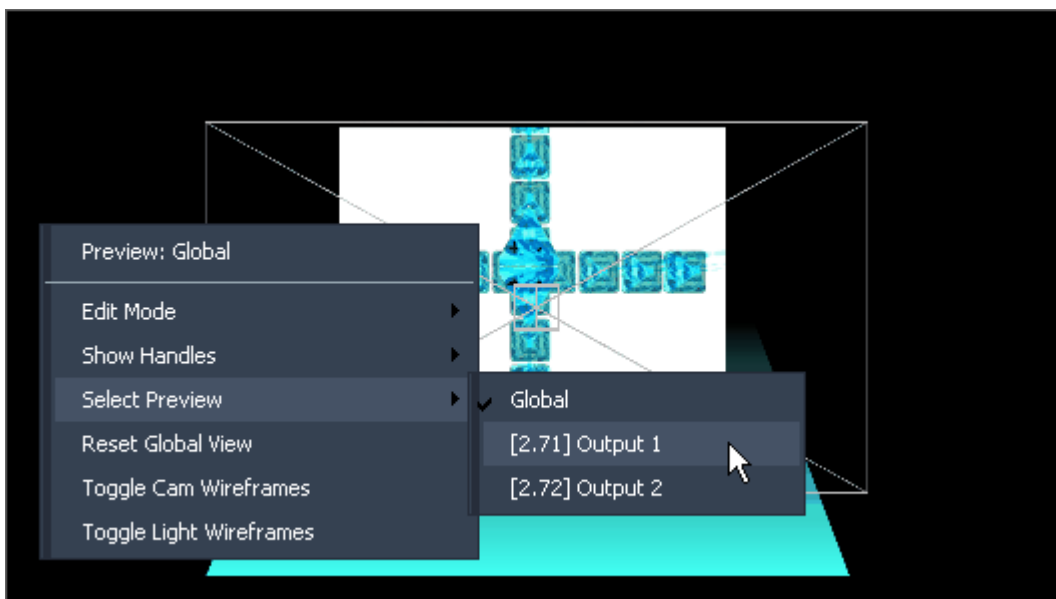

When working e.g. with LED walls that are controlled via Art-Net you can choose to preview the Art-Net output instead of the video (e.g. DVI) output. Whilst being in the output (!) view right-click and select a matrix mask. To use the matrix feature you first need to create a patch in the [Matrix Patcher](#)<sup>757</sup> and export it in real-time to your Pandoras Box project. Drag the new format ".pbx file" on any(!) [output](#)<sup>597</sup>. Now, you may choose to preview it as described above.

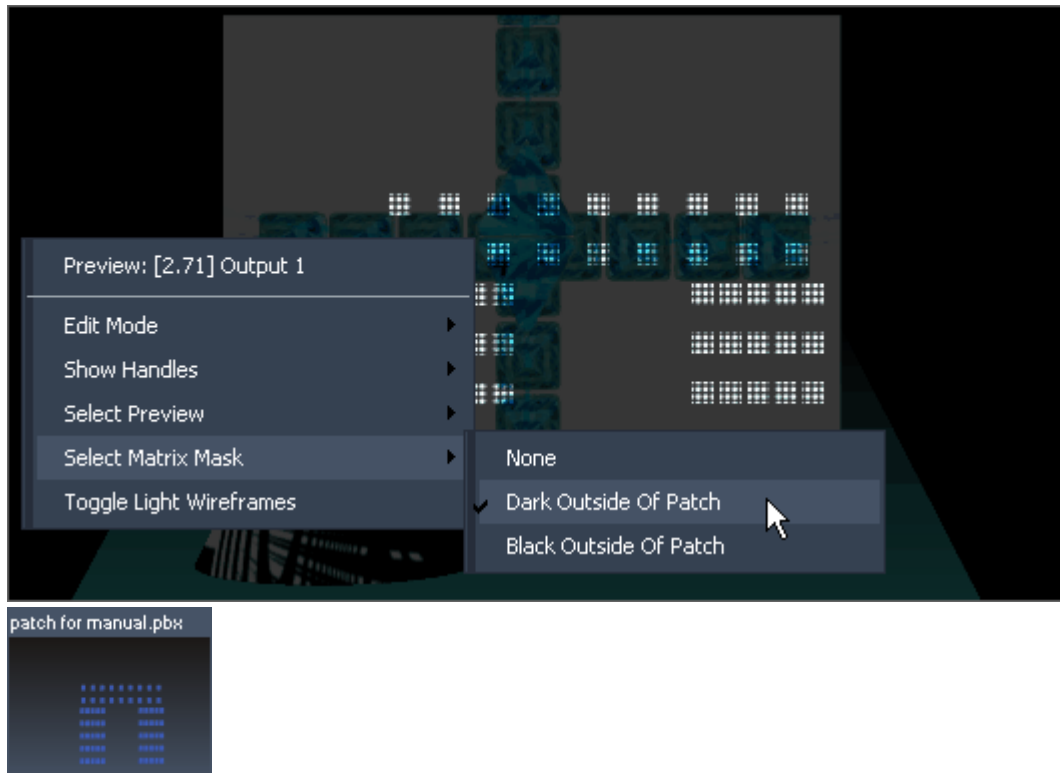

### Previewing several servers with different camera offsets

In the example below a softedge projection with 4 outputs is shown (the 4 outputs have different X-offsets). You can easily see which part of the whole composition is given out by each output.

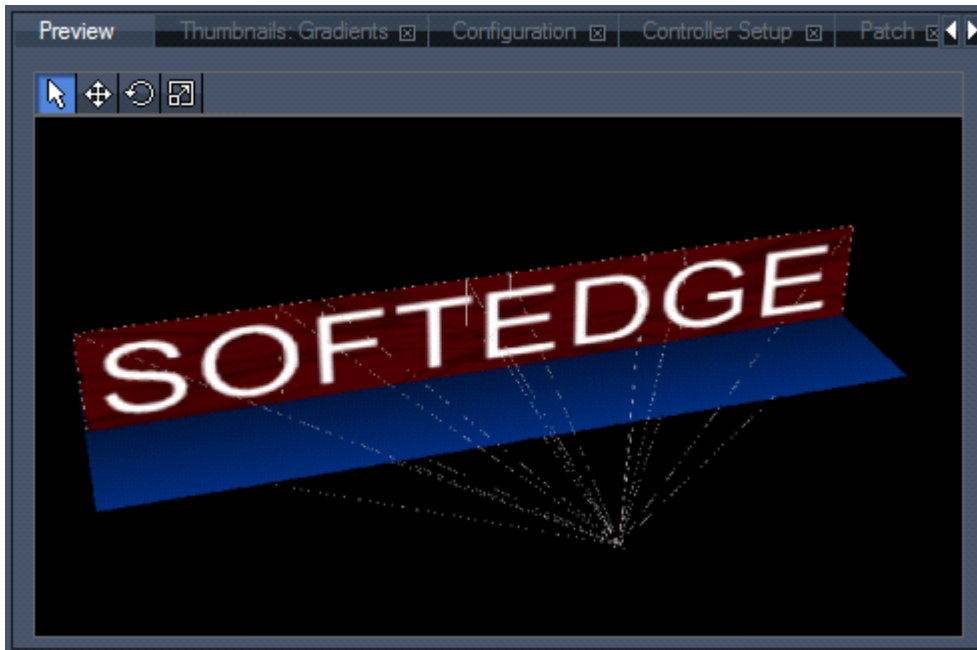

When changing the preview to show the single outputs, each one would show its area according to the wireframes:

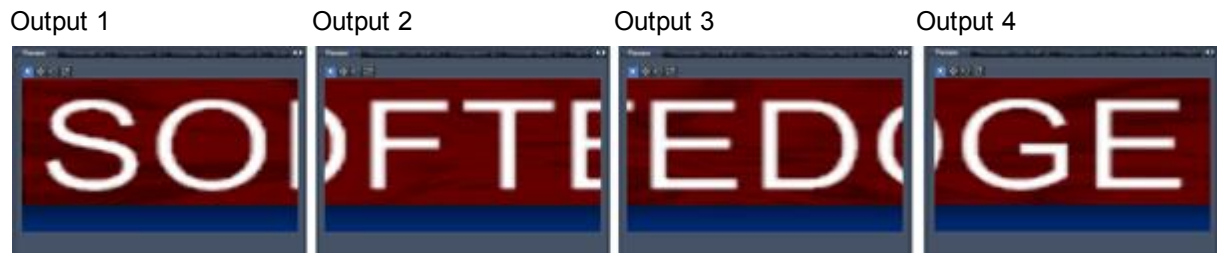

### Previewing several servers with equal camera offsets

Having sites that run separately from each other (with no X/ Y Camera Offsets), the sites outputs will overlay in the global preview by default. The output at top is from the site that was added to the project at last. In the inspector of site 1 and site 2 the preview offset of each site may be changed. This way both sites can be shown at the same time.

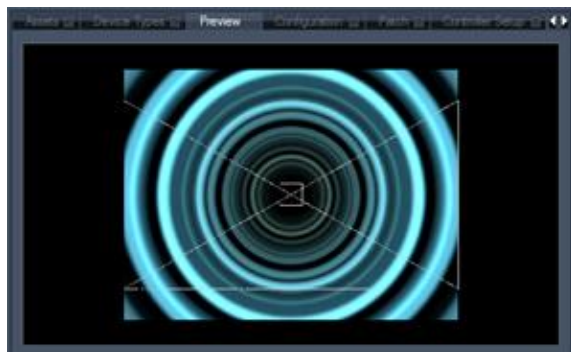

When changing to global cam view only site 2 is visible, because it was added to the project at last, it overlays the preview image of site 1. In the Device Tree tab select site 1 or 2 and turn over to the inspector...

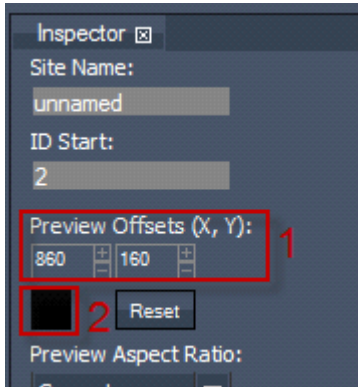

...and modify the preview offset of a site by

- (1) entering X and Y values manually in the text fields or
- (2) click in the little box and move the mouse while holding the left mouse button clicked.

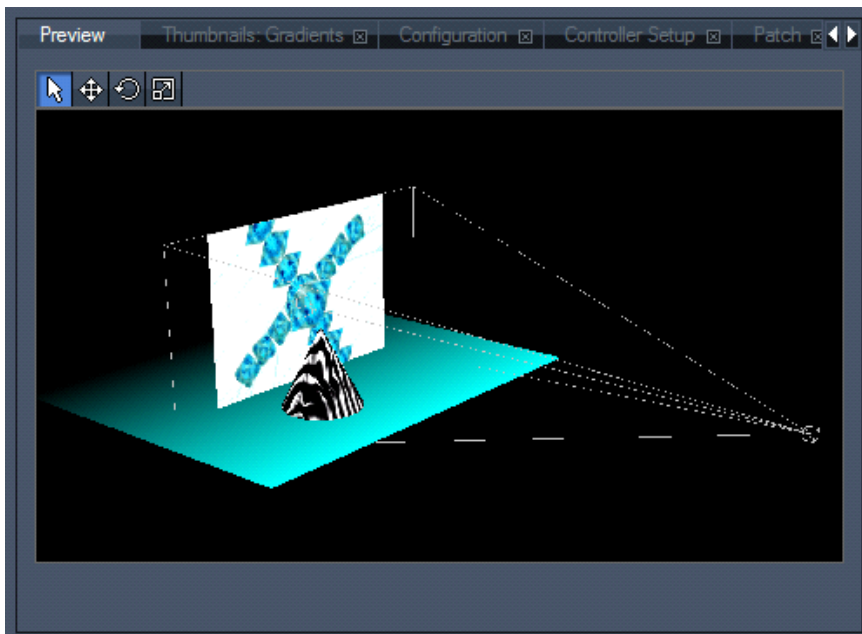

Image left: having different preview offset values applied to the sites allows you to see both at the same time.

The [next chapter](#)<sup>237</sup> explains how to rotate, pan and zoom within the Preview tab.

### 5.2.3.19.3 PREVIEW NAVIGATION

Within the global cam preview you may zoom the view and have a look at your composition from any point in the 3D space, see image below.



For zooming the global cam view use the mouse scroll wheel.  
 For positioning the cam in X and Y axis move the mouse while holding the mouse scroll wheel pressed.  
 For rotating around in 3D space move the mouse while holding the mouse scroll wheel and the [ALT] key pressed at the same time.

Please note: changing the view in the global cam does not influence the output at all! The output will still show the same area as before, as shown in the image below.

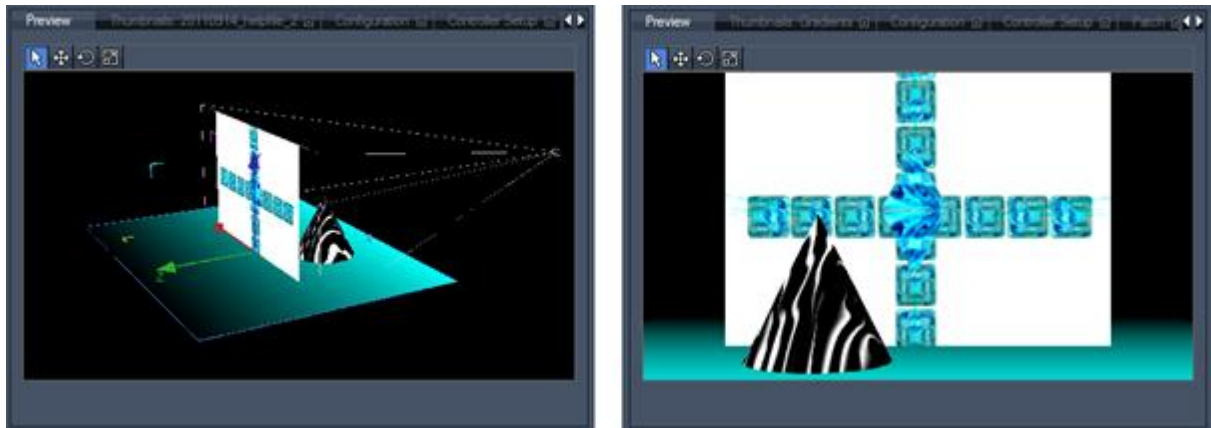

Please have a look in the last chapter if you like to know about the difference between [global cam view and output view](#)<sup>[234]</sup>.

The [next chapter](#)<sup>[238]</sup> explains what wireframes and pivot handles are for...

### 5.2.3.19.4 PREVIEW HANDLES AND WIREFRAMES

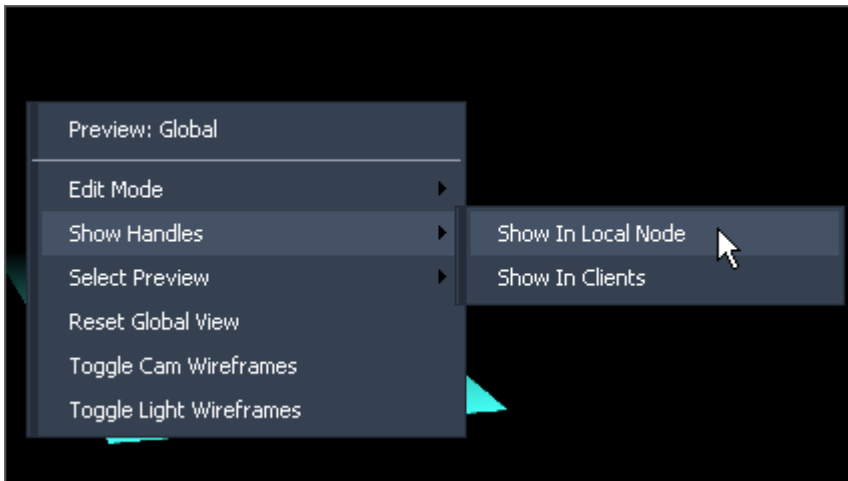
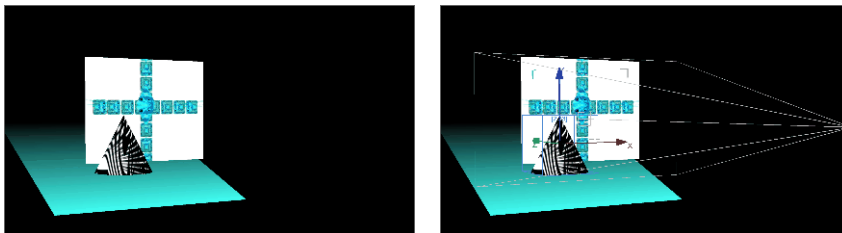

In this chapter the different kinds of handles are explained. To basically enable them to be shown in the global cam preview or in your real output(s), please make sure that the option “Show Handles” is activated. Do this by right-clicking in the Preview tab > Show Handles > Show in Local Node (e.g. your Manager) or > Show in Clients (e.g. the display attached to a server).

The different kind of handles are:

- the three-colored pivot handles (also called gizmo).

The pivot point marks the layer's center point regarding its position and rotation and scaling. That means there are three different pivot points. How to use the pivot handles interactively is described in the [next chapter](#)<sup>239</sup>.

- the white wireframes (also called cam wireframes).

These wireframes mark the camera target of the previewed site and thus define the area that is actually shown from the display attached to the graphic card.

Toggle the cam wireframes on and off separately within the global cam's right-click menu. Note that the handles must be turned on in any case.

- the yellow wireframes (also called light wireframes).

These wireframes mark the light cone belonging to a [light layer](#)<sup>582</sup>.

Toggle the cam wireframes on and off separately within the global cam's right-click menu. Note that the handles must be turned on in any case.

### 5.2.3.19.5 INTERACTIVE PREVIEW: PIVOT HANDLES

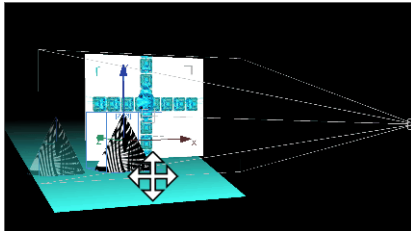

Since version 5.0 Pandoras Box allows to interact directly with the layers in your Preview tab. It is possible to select, move, rotate and scale content directly within the Preview interface. This allows faster editing and intuitive layer composition.

This feature may be used in both preview modes: [the global cam and a single output preview](#)<sup>234</sup> and is described in this topic.

With the feature "Layer Picking" in version 5.3, the content interaction has gone one step further. It is now possible to recalculate the mouse position within the preview or even the client's fullscreen window and thus recognize what layer is touched and where exactly on the layer the mouse is located. A layer has become a true interface. [The next chapter](#)<sup>244</sup> explains "Layer Picking" in more detail.

Pivot Handles allow you to select, move, rotate and scale a layer directly in the Preview tab.

This feature may be used in both preview modes: [the global cam and a single output preview](#)<sup>234</sup>.

First of all the pivot handles need to be shown in the preview. Right-click inside the preview and make sure that "Show Handles" > "Show In Local Node" is enabled as explained in the [last chapter](#)<sup>238</sup>.

When the option "Show Handles" is enabled for the Preview and/or the Client output, the handles for X/Y/Z of the selected layer are shown in the preview, as seen in the image below. The device ID of the selected layer is shown as well (in this example: device ID 2.1).

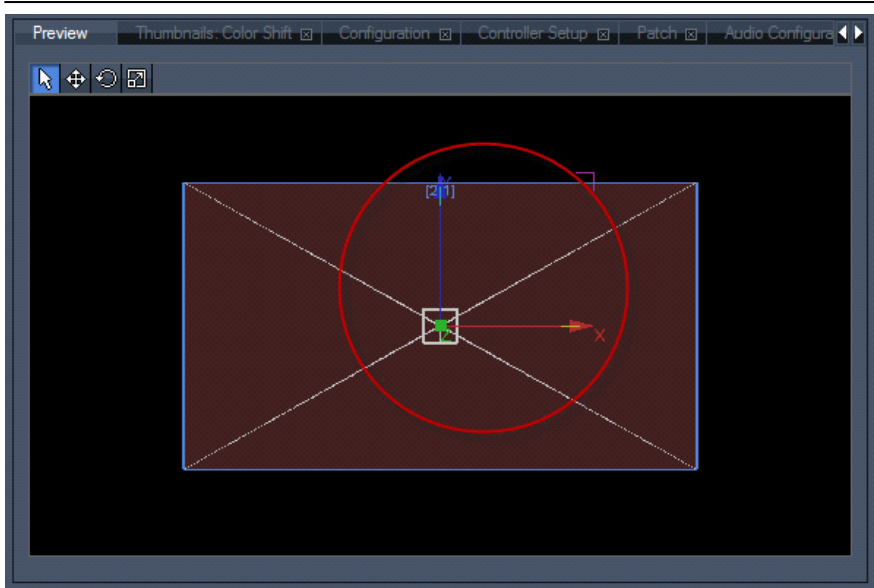

Depending on the Edit Mode chosen for the handles, they can be used to

- select a layer / show the center point of the selected layer
- move a layer (changing its position values)
- rotate a layer / show the layer's rotation pivot
- scale a layer / show the layer's scale pivot
- ... directly within the preview.

See here the different edit modes:

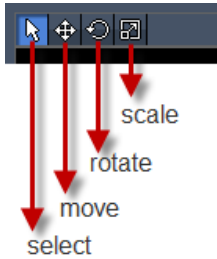

The edit modes can be chosen by:

- clicking on the according icon on the top left inside the preview tab (see image above)
- doing a right-click inside the preview tab > Edit Mode (see image below)

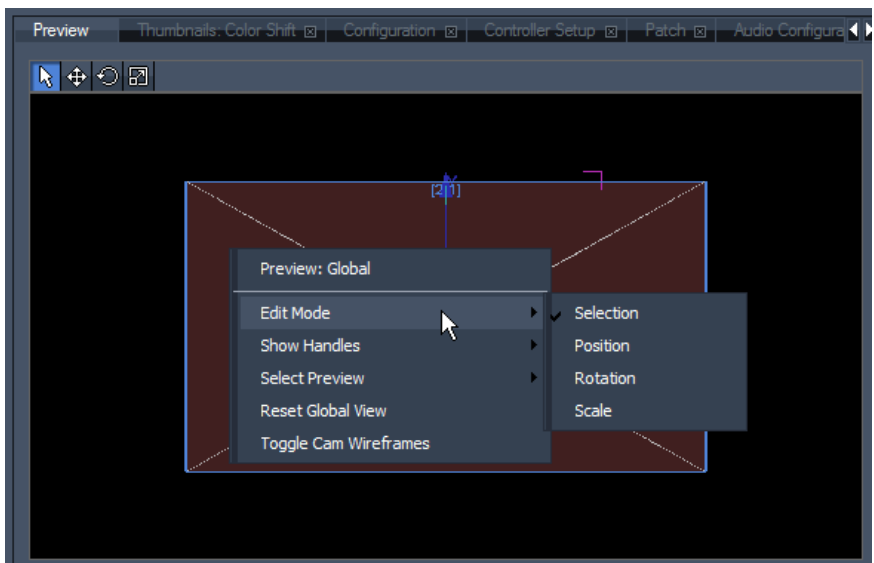



## Moving a layer

If you want to move a layer from within the preview choose the edit mode “Position”. The mouse cursor changes to a cross. You have the possibility to move the layer in one axis only by placing the mouse cursor over a single handle (the handle will be highlighted) or to move it in several axes at the same time by placing the mouse cursor somewhere on the layer, see example below:

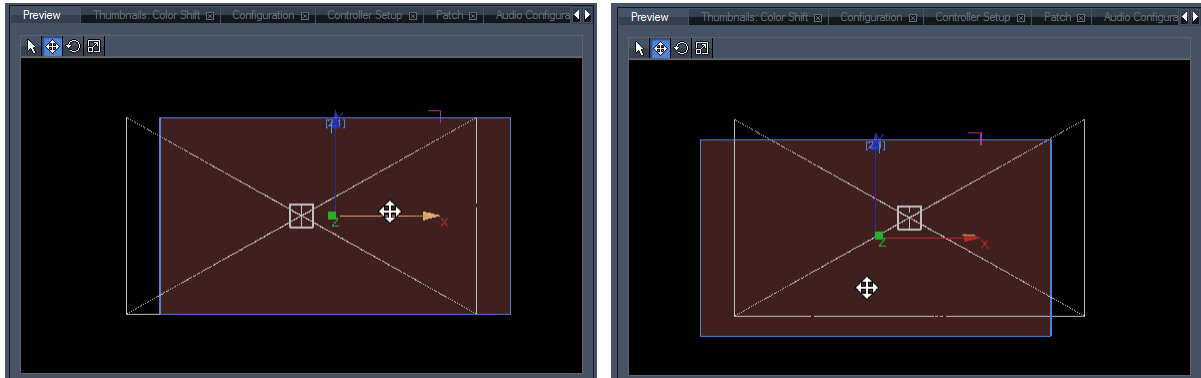

Image above:

Left: the cursor is placed above the X axis handle, the handle is highlighted and the layer may only be moved in X

Right: the cursor is placed somewhere on the layer, the layer may be moved in X and Y at the same time.

## Rotating a layer

If you want to rotate a layer from within the preview choose the edit mode “Rotation”. The mouse cursor changes to a circle.

You have the possibility to:

- rotate the layer in one axis only by placing the mouse cursor over a single handle (the handle will be highlighted) or to rotate it in several axes at the same time by placing the mouse cursor somewhere on the layer.
- move the [layer's rotation pivot](#)<sup>311</sup> to another position by placing the mouse cursor over a single handle (the handle will be highlighted) and holding the [ALT]-key pressed or to move it in several axes at the same time by placing the mouse cursor somewhere on the layer while holding the [ALT]-key pressed.

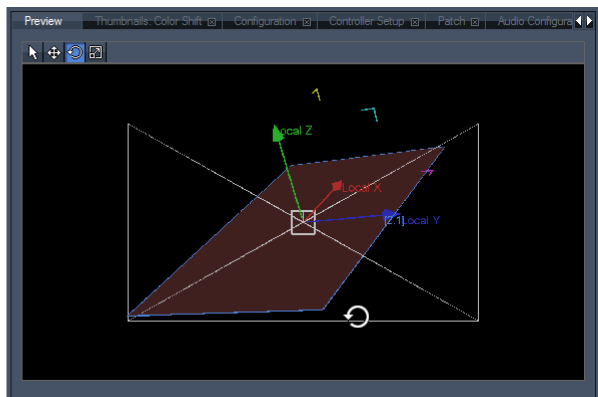
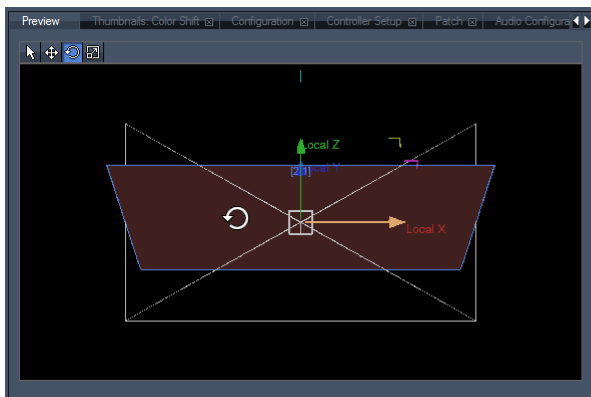

Images above: rotating a layer:

Left) in X Axis only

Right) in all three axes at the same time

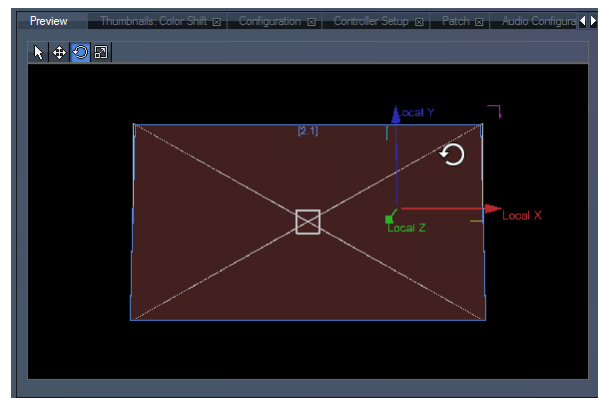
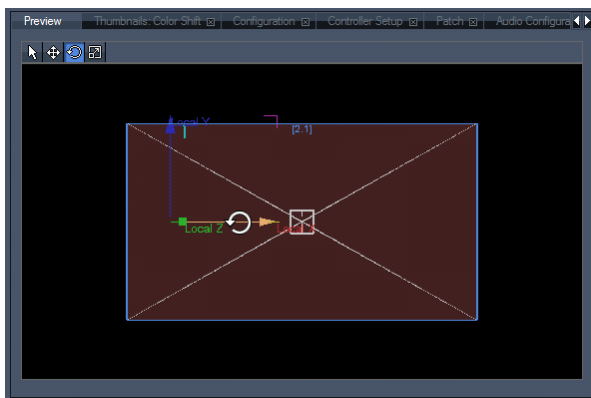

Images above: moving the layer's rotation pivot

Left) in X Axis only

Right) in all three axes at the same time

## Scaling a layer

If you want to scale a layer from within the preview choose the edit mode “Scale”. The mouse cursor changes to a scale icon.

You have the possibility to:

- scale the layer in one axis only by placing the mouse cursor over a single handle (the handle will be highlighted) or to scale it in several axes at the same time by placing the mouse cursor somewhere on the layer.
- move the layer's [scale pivot](#)<sup>313</sup> to another position by placing the mouse cursor over a single handle (the handle will be highlighted) and holding the [ALT]-key pressed or to move it in several axes at the same time by placing the mouse cursor somewhere on the layer while holding the [ALT]-key pressed.

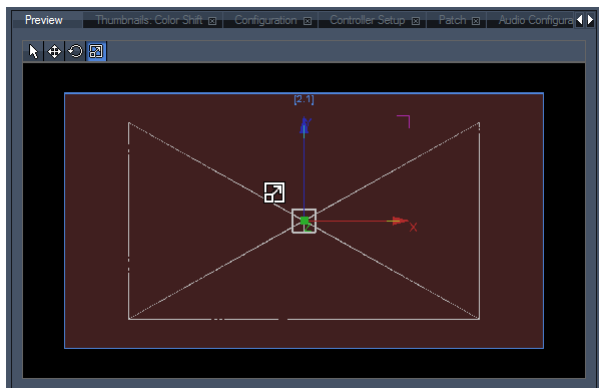
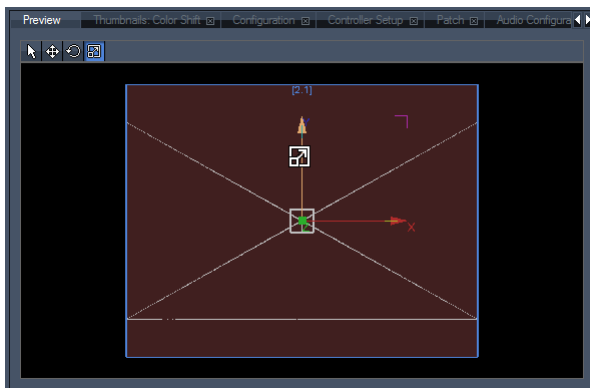

Images above: scaling a layer

Left) in Y Axis only

Right) in X and Y at the same time

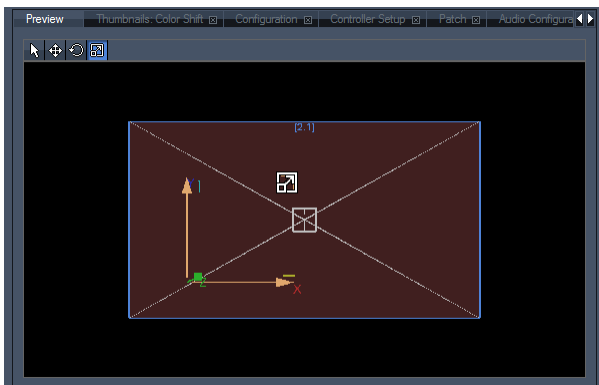
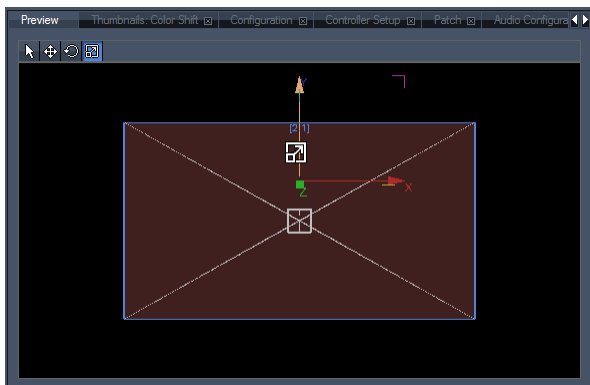

Images above: moving the layer's scale pivot

Left) in X Axis only

Right) in all three axes at the same time

### 5.2.3.19.6 INTERACTIVE PREVIEW: CONTENT AS INTERFACE (LAYER PICKING)

In addition to the pivot handles (see [last chapter](#)<sup>239</sup>), the feature "Layer Picking" allows to use a layer as an interface, i.e. interact directly with it. To give an example, Layer Picking can be used to execute hyperlinks in rendered web pages, so called [Browser Assets](#)<sup>248</sup>.

Layer Picking "captures" the position from the mouse pointer and if the mouse is moved in your master's Preview tab or the client's fullscreen window the feature recognizes what layer is touched and where exactly on the layer the mouse is located. A layer can now be used as a true interface. In addition mouse clicks can be passed through.

The term "mouse pointer" actually does not only refer to a mouse device but to any device that is recognized by the operating system as a pointing device and can send these input events. This includes for example an AirScan or a touch screen if they are set up to do "clicks". If you are working with an Windows XP system only one input event can be sent, whereas Windows 7 is able to work with multi-touch events.

The input events can be sent from a local pointing device. Let's say for example you have a client that renders layers in full screen that should be clicked with an AirScan. Connect the AirScan directly to the client to receive local input events. Another possibility is to connect the AirScan to another computer which sends the input events to the client through a so called "Mouse Injection". A Mouse Injection node can be found in the Widget Designer.

To activate click events, select the client in the [Device Tree tab](#)<sup>168</sup> and turn to its [Inspector](#)<sup>206</sup>. The button "Input Settings" opens a dialog where you can activate your output(s) of choice and the option to route the inputs to layers. As a second option you may route the inputs to Widget Designer, you then know where the mouse is located e.g. on-top of Layer 1 and work with this data. Routing them to a [Widget Designer Device](#)<sup>609</sup> requires this device in your Device Tree, please see below example. If you like to be able to click in the rendered preview tab on your Master, simply activate the "Picking Mode" by highlighting the link symbol in the right upper side from the tab as seen in the left image at the bottom.

The last setting in the Device Inspector lets you display the mouse cursor on-top of the fullscreen. Alternatively you may use "[Pointer Layers](#)<sup>581</sup>"; they offer more creative options like displaying a picture or even a Particle System instead of a simple cursor. Depending on the layer's opacity, this Pointer Layer is automatically shown:

- a) in the Preview tab if you are in the picking mode and toggled to the according output view
- b) in the client's small render window
- c) in the client's fullscreen render window

Please follow these steps to use Layer Picking with a Widget Designer Device: (note that a layer must be rendered in the [composition pass](#)<sup>297</sup>). If you are interested how you can use the Preview's interaction data to draw on a Canvas asset, please see the "[Layer UV Draw to Canvas](#)"<sup>1150</sup> chapter. If you like to use the data to click on Widget Designer's [Custom Script Buttons](#)<sup>884</sup>, please see its chapter.

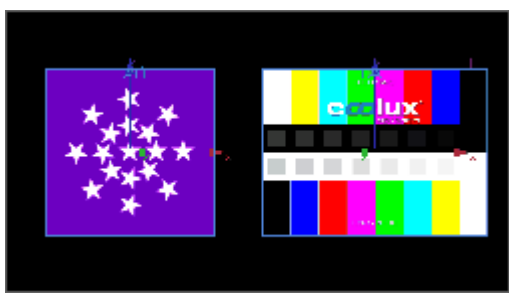
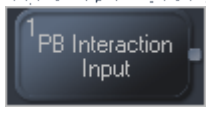
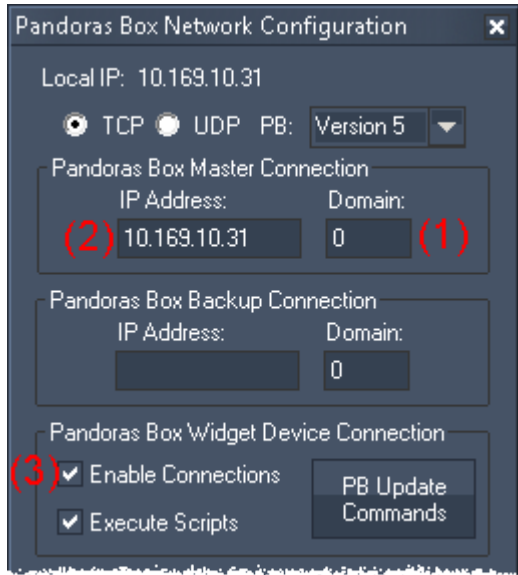

First of all start the Widget Designer 4.0 and enable the connection to a Widget Designer Device in Pandoras which we will set up in the next step.

To do so, right-click in the main window and choose "[Pandoras Box IP Configuration](#)<sup>865</sup>". Then make sure that the Domain (1) and IP address (2) under "Pandoras Box Master Connection" matches with the PC where Pandoras Box Manager or Player /Server as master is running on. In Pandoras Box, the IP address is shown in the Assets tab, the Domain in the Configuration tab.

Have a look in the section "Pandoras Box Widget Device Connection" and enable the check box "Enable Connections" (3). You can close the dialog, but remember the button "Input Tester", it opens a dialog that displays incoming information.

Press Alt+N and create the following node: Input > Pandoras Box > Layer Interaction (the input nodes "Layer Mouse Input" and "Layer Touch Input" can be used in later projects as well). Make a right-click on the node and choose "Item Properties". In this dialog again, make sure that the IP address matches with Pandoras Box.

So far, everything is set up in Widget Designer, please switch to your Pandoras Box master software.

After creating a project, program layer 1 and 2 next to each other so that your preview looks something like the example to the left.

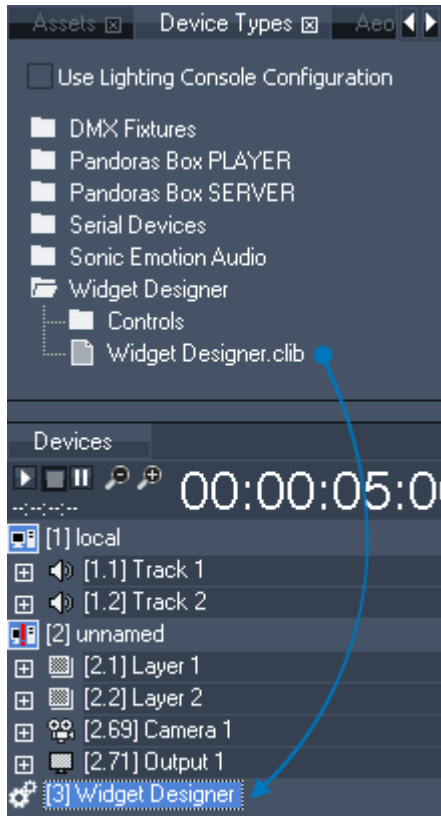

As already mentioned we need to send the data to a Widget Designer Device. For this, go to the "Device Types" tab > "Widget Designer" > and drag the "Widget Designer.clib" into the Device Tree.

As we have already set up the WD in the first step, the device can connect successfully.

If you see a red exclamation mark in the symbol within the Device Tree (as shown in the left image for the server device), check the IP address and domain number (in the Configuration tab). If the Widget Designer runs on a different PC, the Widget Designer device must be set to the according IP address. Select the Widget Designer device in the Device tab and edit the text field "IP" within the Inspector tab.

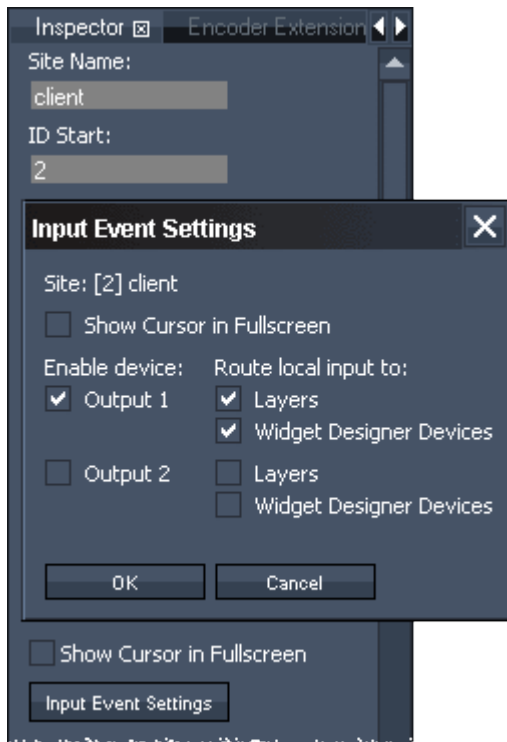

To send the data from the feature inside Pandoras Box to the Widget Designer Device (and then to the Widget Designer nodes) we need to do the following:

First, select the site in your Device tab and have a look in its Inspector. Alternatively you can right-click in the preview and choose "Show Input Events". This opens a dialog that shows the settings for all systems in the Device Tree.

Click "Input Event Settings" and choose under "Route local input to" the check box "Widget Designer Devices". Now, the mouse capturing works if the preview is in the global cam mode. If you like to switch to an output view or if you like to use Layer Picking in the fullscreen window from a client, click the button "Input Settings" and activate the according "Output no." check boxes.

The option to route the local input data to "Layers" passes clicks directly through to the layers. If you are using Browser Assets you can then execute underlying links. In that case a Widget Designer Device is not necessary.

Tick the check box "Show Cursor in Fullscreen" if you like to see the mouse cursor in the client's fullscreen window.

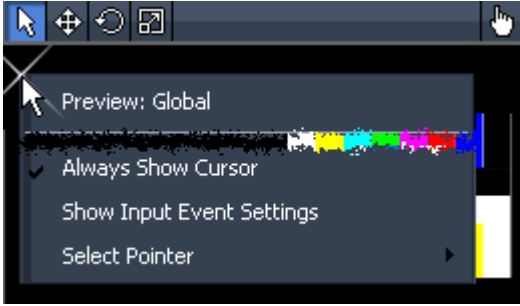

The according option "Always Show Cursor" for seeing the cursor in the Preview tab, can be found in the Preview's right-click menu.

Alternatively you can use [Pointer Layers](#)<sup>581</sup> to visualize the cursor and touch input(s). Right-click in the Device Tree tab, choose "Add Layer > Pointer" and assign any media and effect you would like to see. In case you use Pointer Layers on multiple clients, the Preview's menu offers "Select Pointer" to choose between them.

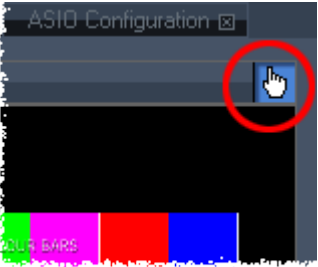

So far we have set up the data routing, now we can already use Layer Picking within a fullscreen window of a client. If you like to use Layer Picking in the Preview tab, you need to activate it separately. Click on the hand symbol in the upper right corner of your preview. If you choose one of the other edit modes to select, position, scale or rotate a layer, Layer Picking will be deactivated automatically and you can use the other interacting tools. Please note, that the data is only transferred when the mouse is actually moved.

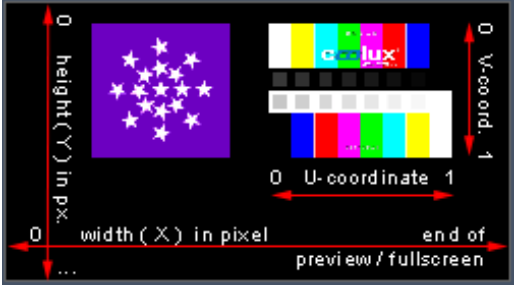

Now we can move the mouse cursor across the Preview tab or the client's fullscreen display and see the according data in the Item Properties dialog from the input node in Widget Designer. Alternatively you can click on the "Input Tester" button in Edit > [Pandoras Box IP Configuration](#)<sup>865</sup>.

The node reports the Site ID and Device ID as soon as the mouse touches a layer. Of course its opacity value must be greater than zero.



X and Y relate to the width and height from the Preview tab or fullscreen window and are measured in pixels.

U and V relate to the layer's texture coordinates. They run from 0 to 1, whilst (0,0) marks the upper left and (1,1) the bottom right corner of a rectangular texture. Of course, having an object e.g. a cone assigned to a layer will result in other coordinates. The UV-coordinates are saved within the object file.

The mouse buttons (value 0 or 1) and the wheel (value depending on mouse) report whether the according button was pressed or the wheel was used.

The left image shows the reported data in Widget Designer: the mouse touches layer 2 from server 2 and hovers above its UV-coordinate (0.1,0.5) whilst the XY-coordinate in the Preview tab is (316.160) pixel.

### 5.2.3.20 PROJECT

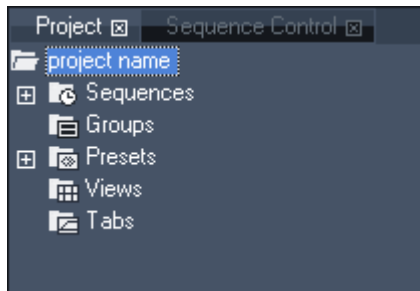

The Project tab holds all information regarding available media files (called assets), sequences, groups, presets, views and tabs. Whereas all devices that are managed by the project are located and displayed in the [Device Tree tab](#)<sup>168</sup>.

Please see the following chapters about:

- [Media files](#)<sup>248</sup> and folder structure
- [Sequences](#)<sup>251</sup>
- [Groups](#)<sup>251</sup>
- [Presets](#)<sup>253</sup>
- [Views](#)<sup>286</sup>
- [Tabs](#)<sup>258</sup>

#### Commands in the Project tab

Right-click in the Project tab, e.g. on the very first folder and choose:

"Spread all Resources"

to copy all files from the master system to all connected clients. If you have done this before, a file will only be re-spread if it has changed

"Add..."

to add another media source to the project. The [supported media](#)<sup>248</sup> is described in the next chapter

"Save As"

to save the current project with a different name and path

"Remove Unused Resources"

to delete media that is not used in any of the sequences

### 5.2.3.20.1 MEDIA FILES

#### Adding media files to the project and spreading it

The Project tab lists all available media files. Only media that is part of the project can be used by layers. Add media files to the project by dragging them from the [Assets tab](#)<sup>137</sup>, from the [Thumbnails tab](#)<sup>280</sup>, or from an external file explorer.

You may drag single files or entire folder(s), optionally including subfolders.

Pandoras Box creates links to the media file, it will not copy the file!

After adding content to the project it is automatically spread to all connected systems, if this default setting is not deactivated in the [Configuration tab](#)<sup>139</sup>. "Spreading" actually copies files to the other hard disk. If the Auto-Spread function is deactivated you may spread single files or folders with the according "Spread" command in the right-click menu. Content that was spread already is only copied again if the file has changed.

Again, Pandoras Box creates a link to it, so if you move content to another folder, either on the master system or a client system, the links point to a nonexistent file and it can not be displayed. In the Project tab, the so called inconsistent file is then marked with a red explanation mark. To view the file paths click the file and look into the [File Inspector](#)<sup>190</sup>.

An exception to this rule is when you are using content from the project's "asset folder". As soon as a project is saved, a folder named "assets" is generated just next to the show file. If you copy content files to that folder and drag them from here into your Pandoras Box project the content links are relative. That



means that you can move the project folder ( including the \*.xml and asset folder) to every path wanted without the inconsistency effect and the need of re-linking the content. This is especially of interest for users that use the "[Bundle Project](#)<sup>129</sup>" feature.

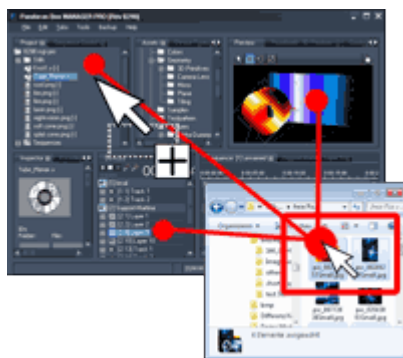
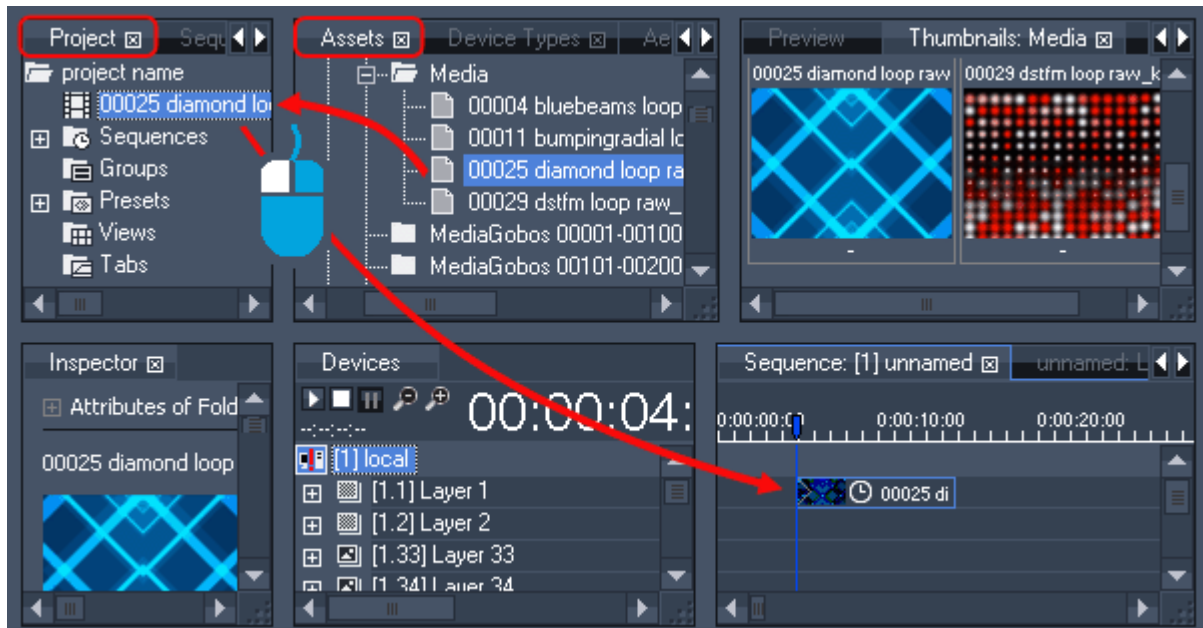

Since version 5.5 it is possible to add media files from an external file explorer like the Windows Explorer for example. You may drag the files (or entire folders) into the Project tab, into the Preview tab or on a layer in the Device Tree tab.

Files that can be included (or rather linked) from the hard disk to Pandora's Box are described in the content chapter, detailing supported formats as well. You may add:

- [Audio files](#)<sup>98</sup>
- [Still Images](#)<sup>98</sup>
- [Image Sequences](#)<sup>99</sup>
- [Videos](#)<sup>102</sup>
- [Matrix Patches](#)<sup>757</sup>

Other media types are described below.

## Different media types

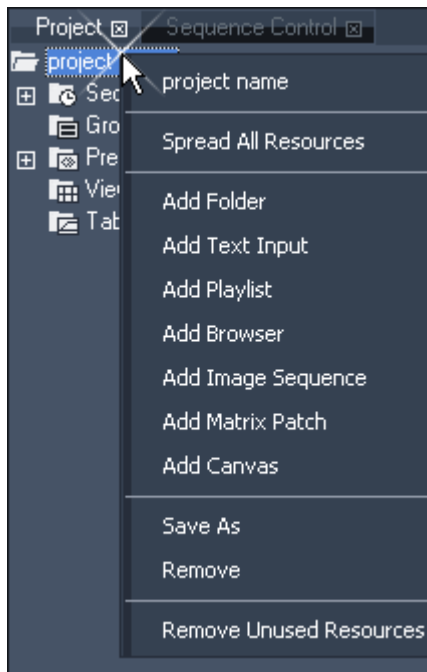

In addition to the above described media types, Pandora's Box supports other media sources. Mostly they are created in the project itself and are stored in it.

Right-click in the Project tab, e.g. on the first folder, to add one of the following assets:

### Text Input

displays text (in various formats). When the new text entry is selected, you can change its properties in the [Text Inspector](#)<sup>197</sup>. At the top there is a button to open the "Text Input Editor" tab where you can modify these and more settings.

A text input can be displayed by any layer starting from a simple [Graphic Layer](#)<sup>577</sup>. If you are using the "Play" function e.g. for scrolling text, a Video Layer is needed.

### Playlist

plays back various media files (images and videos) one after another with an optional cross-fade on ONE layer. There is no need to program all files separately in the timeline. To modify the Playlist, e.g. add content or change its order, open it in the [Playlist tab](#)<sup>229</sup>. A playlist can be displayed by any layer starting from a simple [Graphic Layer](#)<sup>577</sup>, if videos are included a layer with

a Playback functionality is needed, e.g. a [Video Layer](#)<sup>298</sup>.

### Browser

is able to render a web page. See its properties in the [Browser Inspector](#)<sup>192</sup>.

A browser asset can be displayed by any layer starting from a simple [Graphic Layer](#)<sup>577</sup>. Please note that the render and loading process might take up to 15seconds depending on the texture size and web site complexity. This is also subject to the internet connection.

A browser asset can be clicked as well, e.g. to execute included hyperlinks, if the feature [Layer Picking](#)<sup>244</sup> is activated in the respective [Device Inspector](#)<sup>206</sup>. A click input can be displayed by a [Pointer Layer](#)<sup>581</sup>.

### Image Sequence

is an alternative to video files, see the differences in the according [Content chapter](#)<sup>99</sup>. The best way to add an image sequence is actually found in the Assets tab. Right-click on a folder and choose "Import as Image Sequence". Choose the frame rate in the pop-up. More options can be found in the [Image Sequence Inspector](#)<sup>194</sup>. An image sequence can be displayed by any layer starting from a simple [Graphic Layer](#)<sup>577</sup> but if you like to play it back a [Video Layer](#)<sup>298</sup> is needed.

### Matrix Patch

feeds displays like LED walls that are connected via Art-Net instead of VGA, DVI or HDMI. You may add an existing Matrix Patch file using the Assets tab. If you create a new one in the Project tab, the [Matrix Patcher](#)<sup>757</sup> opens with a new file. Matrix patch files are meant to be used on a [Output Layer](#)<sup>597</sup> or with an Aeon FX e.g. [ReMap](#)<sup>525</sup>.

### Canvas

is a dynamic image file. It is not a static image like a bitmap for instance, nor is it a predefined video that has been rendered out beforehand. A Canvas is a still image texture but can receive drawing data, meaning that it can be modified in real-time without the need of saving the image itself! The drawing data is send from the Widget Designer and is generated through all possible tools, like a mouse or the AirScan. You may set up a brush size (dots, circles, or even another texture using it as a brush tip) and the color. This way you can apply the Canvas to a Layer to let your customer interact with your projection just for fun. Or you can use the Canvas to generate a live mask. [More information about the](#)

[settings in Widget Designer...](#)<sup>1150</sup>

Alternatively you can use the [Pandoras Box SDK](#)<sup>1532</sup> to draw on a Canvas.

### Creating and working with content folders

As Pandoras Box only creates links to files on the hard disk it is possible to create a folder structure in the project that is independent from the one on the hard disk. You may create content folders that only exist in the project, not on the hard disk. On the other hand you may drag entire folders from the hard disk to the project and the entire folder structure including all subfolders is used, but again, it is only linked. This means, that you are free to alter the folder structure.

Right-click in the Project tab, e.g. on the first folder, and choose "Add Folder". After selecting it, you may rename it with another right-click or the shortcut F2.

Since version 5.5 you may turn a folder into a so called watch folder. This will automatically add a media file to your project if it is added to the watched folder on the hard disk. You may as well use the above described project's assets folder as a "Watch Folder" in Pandoras Box... Read more in the [Folder Inspector](#)<sup>198</sup>.

#### 5.2.3.20.2 SEQUENCES

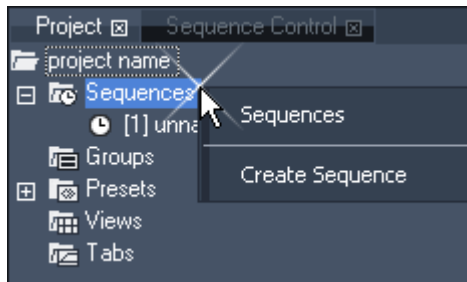

The Sequence folder in the [Project tab](#)<sup>248</sup> includes all available sequences. Depending on the Pandoras Box version (please see "[Product Overview](#)<sup>65</sup>") you are using as the master system, you are allowed to create more than one sequence. To do so, right-click on the sequence folder and choose "Create Sequence".

A new sequence with a new ID is created. To rename it, right-click on the new sequence. The other commands available in

this context menu are the same as in the [context menu](#)<sup>262</sup> when you right-click in the time bar within the [Sequence tab](#)<sup>260</sup>. This chapter also explains how to program using the sequence and how to navigate.

Alternatively there are explained in the chapter "[Sequence Control](#)<sup>273</sup>". This tab displays all available sequences as large thumbnails. Among others, it enables you, to toggle play / pause of various timelines with one click only.

To view the properties of a sequence select it in the Project tab and look into the [Sequence Inspector](#)<sup>200</sup>. It shows all settings, e.g. timecode settings and the master sequence opacity.

#### 5.2.3.20.3 GROUPS

Within Pandoras Box groups define a multi-selection of devices according to their selection order.

To select multiple devices hold down the CTRL key on the keyboard and left-click on the devices to select.

All selected device node icons will turn blue now.

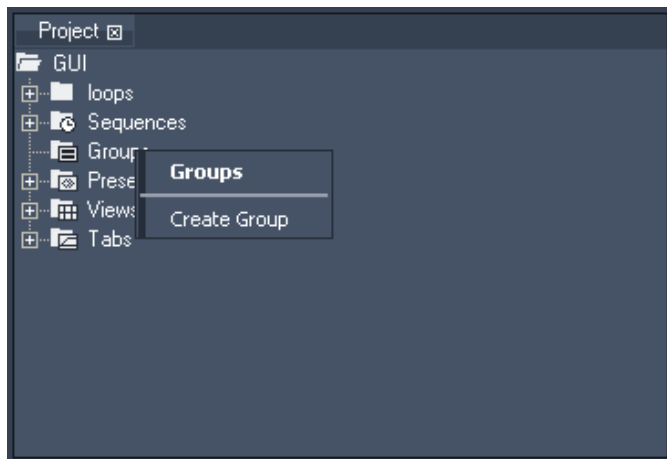

In order to store this selection as a group for later editing, right-click on the group folder in the project tab and choose Create Group.

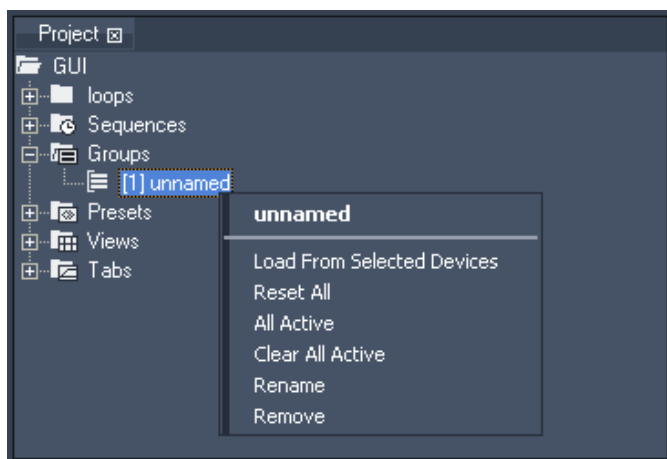

Once the group is created, you can recall the saved selection by simply clicking on the entry. Alternatively you can do this in the [Group View tab](#)<sup>187</sup>.

If you right-click on the group name, the context menu gives access to more functions:

- Load From Selected Devices

This command will overwrite the actual group selection with the current selection in the device tree.

- Reset All

This command will reset all parameters for all devices stored within this group.

- All Active

This command will activate all parameters of all devices stored within this group.

- Clear All Active

This command will de-activate all parameters of all devices stored within this group.

- Rename

This command will allow you to rename the group.

- Remove

This command will delete the group from the project.

To select all devices that are stored within this group, just click on the group name in the project tab.

### 5.2.3.20.4 PRESETS

In Pandoras Box, presets can be used in two ways:

1. A preset can be a single snapshot taken from active values at one point in time. The snapshot may copy all parameters or it uses a predefined parameter filter, e.g. copy opacity values only.
2. A preset can hold an entire set of keys. The "source" keys must be stored in the timeline first before being turned into a preset. Again the recorded parameters may be chosen.

Both preset variations can be applied at any (other) point in time to any (other) layer. In this way one situation can be created and then be reused severally in the programming process.

In addition a preset can be modified in later programming and automatically change all according keys in the sequence.

#### CREATING A SNAPSHOT PRESET

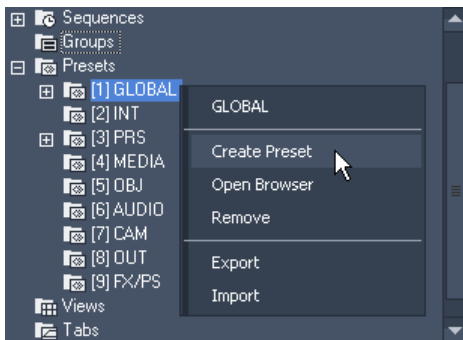

After setting up active values do a right-click on the preset type you want to use and chose "Create Preset". You can do this either in the "Project Tab" or in the according preset browser (the Tab "[Preset View](#)")<sup>230</sup>.

The parameters that transfer their values to a preset will lose their active status.

Please note:

By default, presets taken this way look at all devices (no matter whether they are selected or not). If you wish to store values for selected devices only, create an empty preset first, then make a right-click on it in the project or preset tab and choose "Store active (Selected devices)".

PRESET TYPE	PARAMETERS STORED
Global	All Parameters
INT	Opacity
PRS	Position, Rotation, Scale
MEDIA	File Selection, Transport Control (Transport, Speed)
OBJ	Object Selection
AUDIO	Audio Parameters
CAM	Camera Control Settings
OUT	Output Control Settings
FX/ PS	FX & Particle System parameters

The preset folder contains default preset banks for active value filtering during store operation. This means that by creating a preset in any of these categories only the parameters that match the category group will be stored.

Example:

When creating a preset in the GLOBAL bank, all active parameters will be stored within this preset.

When creating a preset in the PRS bank, only the active values of position, rotation and scale parameters will be stored in this preset. All other parameter keys are not stored and therefore will remain active.

### CREATING A SEQUENCE PRESET

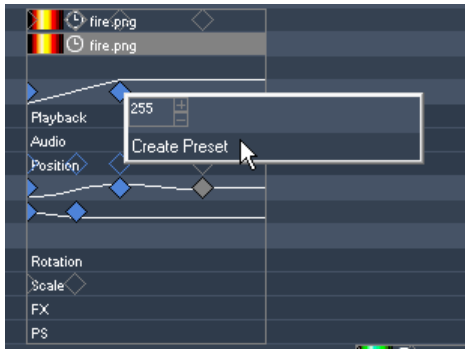

After creating a set of keys in the timeline choose all the keys you want to turn into a preset. In order to make a multi-selection use the SHIFT key. Now make a right-click on one of the keys and choose "Create Preset".

Please note:  
Presets taken within the sequence tab are always stored in the GLOBAL bank.

 Keys that belong to a preset will change their look from the standard diamond icon to an icon that has right angles along the top.

### APPLYING AND PASTING PRESETS



"Applying" a preset to one or more layers will activate those layer parameters that are stored inside the preset. The values are not inserted into the timeline as long as they are not stored intentionally.

Please note: "Applying" a sequence preset will call the first value per parameter and ignore the following ones. E.g., assume a preset has three keys: X Pos = 6 @0sec and 8@2sec; Y Pos = 2 @1sec. The "Apply" command would lead to a selected device having two activated parameters: X Pos = 6 and Y Pos = 2. Importantly, the second X Pos key (with value 8) is ignored in this preset interpretation since only the "leftmost" key for each parameter is taken into account.

Device	Opacity	X Pos...	X Scale
[2.6] Layer 6	175	---	---
[2.7] Layer 7	175	10.800	---
[2.10] Layer 10	---	---	1.530
[2.8] Layer 8	---	10.800	---
[2.11] Layer 11	---	---	1.530

In order to apply a preset, choose the command from the presets right-click menu in the project or preset tab or double-click it in the project tab.

"Pasting" a preset to one or more layers will insert all preset keys into the timeline track (in the currently open sequence at the time according to the nowpointer). These pasted keys are called an "instance" of the preset. The inspector informs you about the associated instance if you select a key in the sequence.

In order to paste a preset, choose the command from the presets right-click menu in the project or preset tab or make a single left-click it in the preset tab.

Applying and pasting presets will always "start" with the selected device. E.g., assume a preset has three keys: Opacity for layer 1, X Pos for layer 2 and X Scale for layer 5. When being used while Layer 6 is selected, Layer 6 itself will obtain the opacity value, Layer 7 the position value and layer 10 the scale value. The lower left image depicts what happens if layer 6 and layer 7 are selected the same time.

You can, of course, repeat the "Apply" and "Paste Keys" commands as often as you like. I.e. the preset is a form of template which allows you to quickly create multiple instances.

### MODIFYING PRESETS

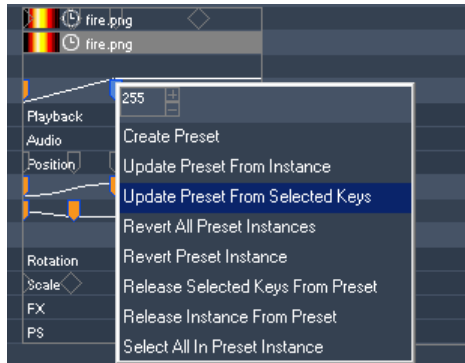

If you change the time or value of a key that belongs to an instance, all associated keys are colored orange to show that the instance diverts from the preset as saved in the project tree.

Starting from a divergent instance, you have four main options:

- 1) apply the changes made in the instance to the master preset and all other instances
- 2) discard the changes and make the instance comply with the master preset again
- 3) transform the keys to be normal keys again, not being included in the instance any more
- 4) create an entirely new preset, starting from this situation

Note that, in the initial version of Pandoras Box that will have these temporally oriented presets, you can only edit a preset by first placing an instance of it in the sequence. In other words, there is no editor available in which to manipulate the master version of the preset directly. However, such an editor is planned for future versions.

#### [Create Preset]

(4) Creates a new preset by mapping all selected keys. Note that non-selected keys would stay orange as their instance has still changed.

#### [Update Preset From Instance]

(1) Applies the changes made in the instance to the master preset. Note that you do not need to select all keys belonging to the instance, all together operate as the new source instance.

The current instance changes its color to grey, all other instances in the timeline change their values additively in order to comply with the new preset.

#### [Update Preset From Selected Keys]

(1) In contrast to the command above, this time not the entire instance operates as the new source for the preset, but the selected keys only.

This command is especially useful if an additional key (either before the first key or after the last key per parameter or one in a totally new parameter) should be added to the preset.

#### Please note:

An instance is always pasted at the time according to the nowpointer. It is always the very first key from the instance that is inserted at the nowpointer's position and all other keys refer to this first key. If you change the preset regarding the first key, the other presets will change so that it is always the first key that holds the time the preset was once inserted. That could mean that other keys change their particular time.

#### [Revert All Preset Instances]

(2) Discard the changes made in one or more instance and make them all comply with to the master preset again.

[Revert Preset Instance]

(2) Discard the changes made in the current instance and make this instance comply with the master preset again.

[Release Selected Keys From Preset]

(3) Transforms all selected keys to normal keys again. They are not included in the instance any more. Note that all other keys from the original instance will change they color to orange, as the instance has now changed.

[Release Instance From Preset]

(3) Transforms all keys belonging to the according instance to be normal keys again. They are not included in the instance any more.

[Select All In Preset Instance]

(-) Selects all keys belonging to the according instance.

ADDITIONAL COMMANDS

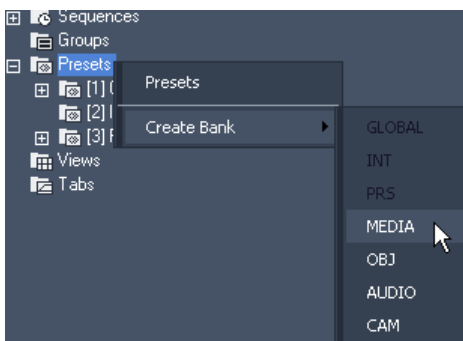

The context menu of the preset folder in the project tab provides the following option for organizing presets:

[Create Bank]

Re-creates a preset banks if it was removed previously.

For each preset folder you may open a designated [browser](#)<sup>230</sup> as an individual tab within the user interface. This tab can be stored in a view as well.

As well you may import previously saved presets to them.

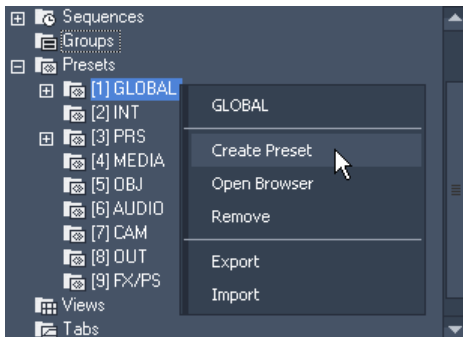

The context menu of a preset type provides the following options for creating and organizing presets:

[Create Preset]

Creates a snapshot preset by looking at the current active values and copying them as a preset key (at zero time) according to the current preset bank.

[Open Browser]

Opens the Tab "[Preset View](#)"<sup>230</sup>.

[Remove]

Deletes the entire preset bank and all including presets.

[Export]

Saves all including presets as an xml file.

[Import]

Adds the previously exported presets to the preset bank.





The context menu of a preset provides the following options for creating, using and organizing presets:

**[Apply (Selected Devices)]**  
 Applies a preset, starting at the first selected layer and activates those layer parameters that are stored inside the preset. The values are not inserted into the timeline.

**[Paste Keys (Selected Devices)]**  
 Creates a new instance from the preset by pasting its keys into the currently open sequence starting at the first selected layer.

**[Revert All Preset Instances]**  
 Discard the changes made in one or more instance and make them all comply with to the master preset again.

**[Store Active]**  
 Stores all active parameter values to the preset that are allowed to be stored in this preset type.

**[Store Active (Selected Devices)]**  
 Stores all active values of the selected devices to the preset.

**[Rename]**  
 Renames the preset.

**[Remove]**  
 Removes the preset.

**[Export]**  
 Saves all including presets as an xml file.

Please refer to [PRESET VIEW tab](#)<sup>230</sup> for further information.

### 5.2.3.20.5 VIEWS

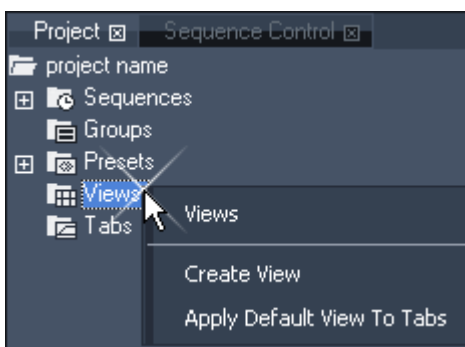

"Views" and the [View tab](#)<sup>286</sup> let you recall stored view layouts of the user interface with a single mouse click. This makes it very easy and fast to switch from one view, e.g. focusing on a large preview window and the AEON FX tabs open, to another view, e.g. displaying not the preview tab but the patch tab and having the sequence and device control tab separated.

The chapter "[Layout](#)<sup>290</sup>" describes how you can influence the GUI layout: inserting new tabs and panes, breaking panes out, removing and resizing them.

Once you have set up a view layout that you would like to store, right-click on the Views folder in the Project tab and choose "Create View".

The new view item has now stored all tab locations and sizes of the user interface. If you're applying any changes now, you can recall the stored view at any time later on by double-clicking on the entry.

Choose "Apply Default View To Tabs" if you want to reset the views to default layout.

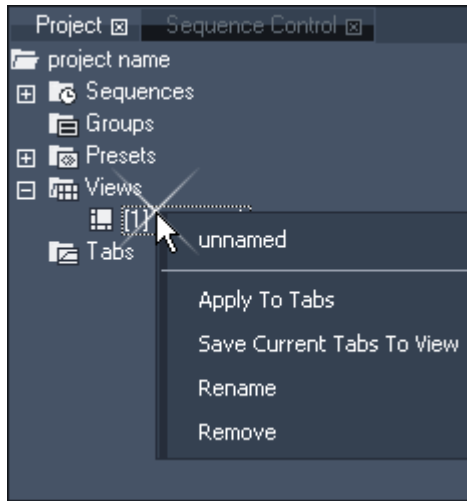

The Views folder holds all stored view entries. If you right-click on them you get access to more functions:

"Apply to Tabs" overwrites the current layout and applies the saved one, alternatively you may double-click on the entry.

"Save Current Tabs To View" overwrites the stored layout with the current one

"Rename" lets you choose another name

"Remove" deletes the view

### 5.2.3.20.6 TABS

To access most of the common used context and main menu commands, custom tabs may be created to allow you a quick access via a single click from within a view layout.

Custom tabs consist of buttons that are especially useful for touchscreen operation with the user-interface as well as for direct access to your favorite features to speed up your workflow.

As tabs are part of your project, all settings you make here will be stored with each project you are working in.

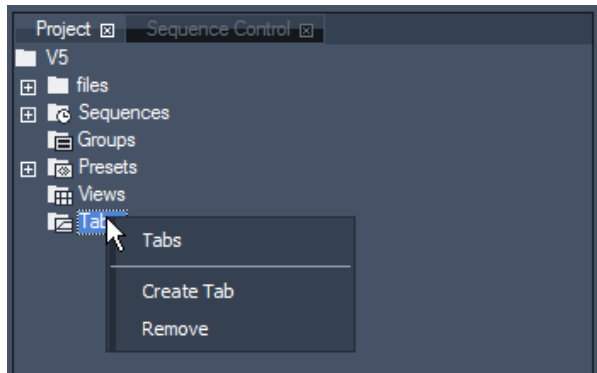

To create a new tab, right-click in the project tab on the folder called "Tabs" and choose "Create Tab".

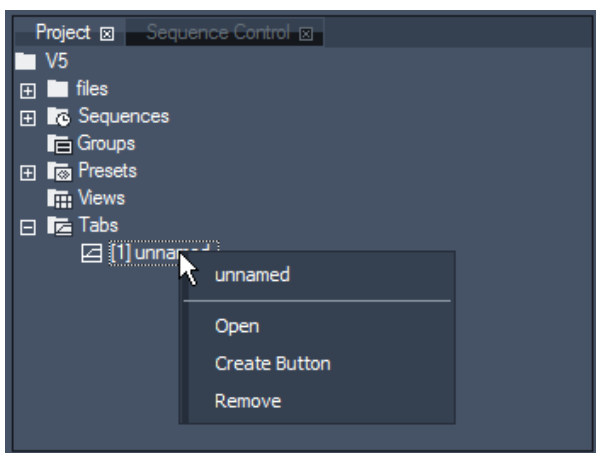

Once a new tab entry is created, you will need to add button items to the tab. Do this by right-clicking on the new tab item and choose "create button".

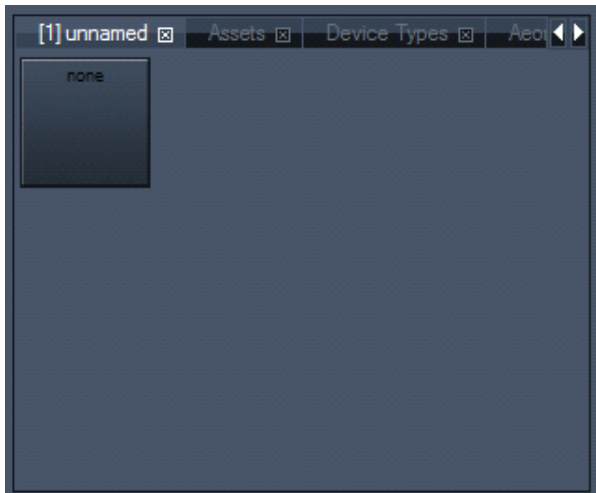

To open and show the new tab in the user interface right-click on the tab again and choose "open". Now you should see a new tab with a single button in the user interface.

To assign a command to this button or to edit the commands of any created button select the button in the project tab. Go to the Button Inspector tab and select your favorite command from the drop down list. You may rename the button here as well.

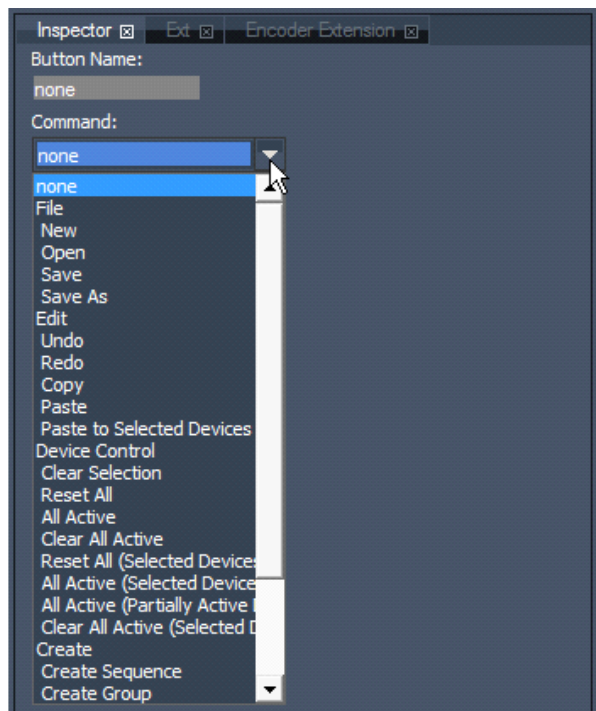
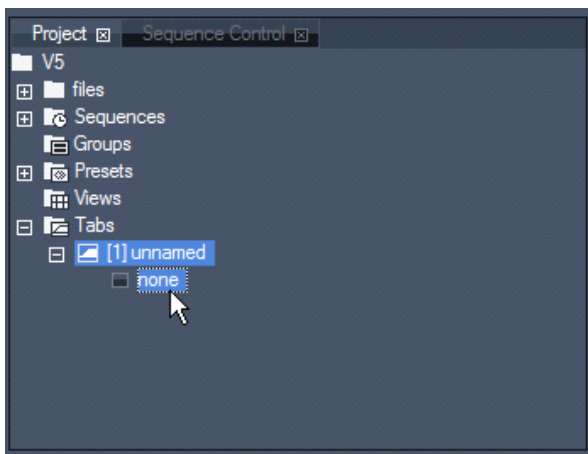

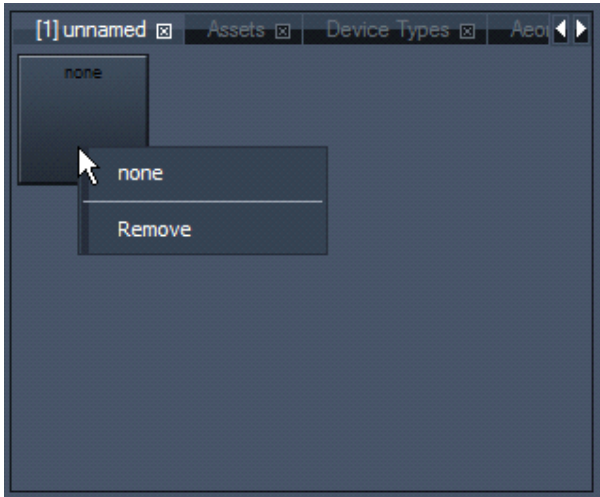

To remove a button from the Button Tab, right-click on it and choose "Remove".

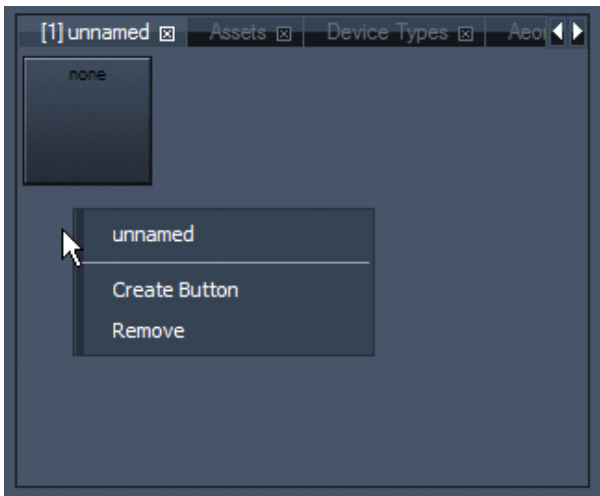

In the Button tab view you may right-click in any empty region to create new buttons.

Choosing "Remove" from this context menu will remove the whole Button Tab from the user interface.

### 5.2.3.21 SEQUENCE

The sequence tab is context sensitive and always displays the selected sequence. Select a sequence from the project tab to load it into the sequence tab.

The next chapters:

- give you a [general overview](#)<sup>261</sup> regarding the layout and terms used
- inform you how to [navigate through the time](#)<sup>261</sup>,
- explain the [commands](#)<sup>262</sup> in the right-click menu
- tell you the most important things you need to know when [programming and working](#)<sup>264</sup> on the timeline
- give a closer look how to set up the underlying principle of value [tracking](#)<sup>269</sup> (i.e. how default values can be enforced without setting keys)

### 5.2.3.21.1 OVERVIEW

Please look at the areas marked with red rectangles in the next illustration for an explanation of the different sequence items.

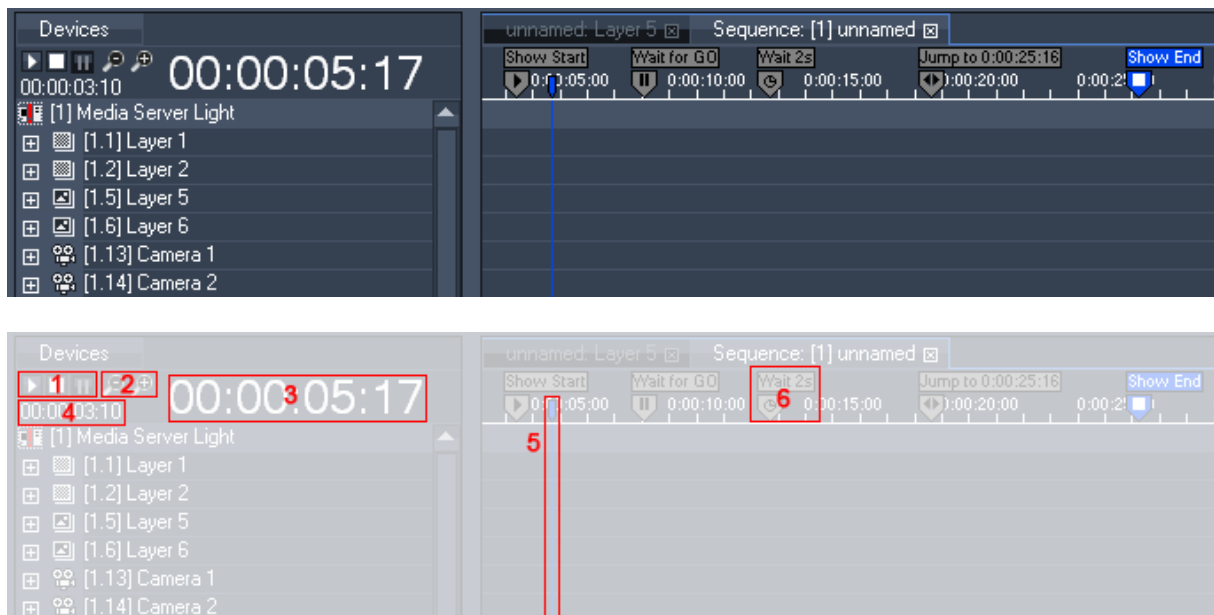

- 1: Sequence Play Mode: Play/Pause/Stop
- 2: Sequence Zooming
- 3: Timecode (current position of the Nowpointer)
- 4: Countdown for next Cue in Timeline
- 5: Nowpointer
- 6: Cue with displayed Cue Name, see [Cue Inspector](#)<sup>204</sup>.

### 5.2.3.21.2 SEQUENCE BUTTON BAR

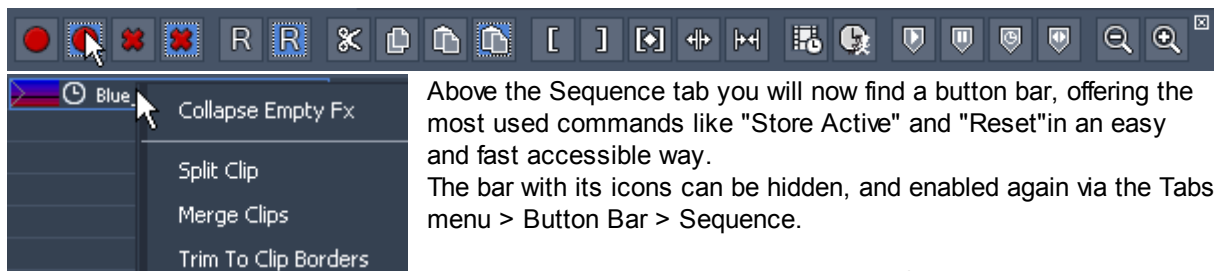

Above the Sequence tab you will now find a button bar, offering the most used commands like "Store Active" and "Reset" in an easy and fast accessible way. The bar with its icons can be hidden, and enabled again via the Tabs menu > Button Bar > Sequence.

When you right-click on a container, you find additional options in the context menu. You may split one clip at the nowpointer's position. If you have several container within the same track selected, you may merge them. If they have different options regarding Lock to time or free-run, media file, mesh file etc., the first container in time wins.

### 5.2.3.21.3 CONTROL

#### Zooming

To zoom in/out the sequence:

- press +/- on your main keyboard or
- click on the zoom tool (magnifying glass icons) on top of the Devices tab or
- hold the SHIFT key and left-click in the time bar (just above the timeline) and move the mouse up and down

## Play/Pause/Stop

To start/pause the sequence, press the space button on your keyboard or use the sequence control buttons Play, Stop and Pause on top of the Devices tab.

## Navigation

- Navigate through the sequence by dragging the nowpointer (blue vertical line) on the time bar.
- You can also enter the desired timecode on top of the Devices Tab. The timecode 00:00:00:00 stands for hours:minutes:seconds:frames. Use this format to enter a new timecode or just type the last numbers, i.e. "409" to get the displayed timecode 00:00:04:09.
- Use CTRL + --> (arrow right) or CTRL + <-- (arrow left) to jump from key to key (including the clip borders).
- Use CTRL + ALT + --> (arrow right) or CTRL + ALT + <-- (arrow left) to jump from cue to cue (including the clip borders)

All available shortcuts for Pandoras Box are included [here](#)<sup>292</sup> as a list.

### 5.2.3.21.4 COMMANDS

To access all sequence commands right-click on the time bar of the sequence tab.

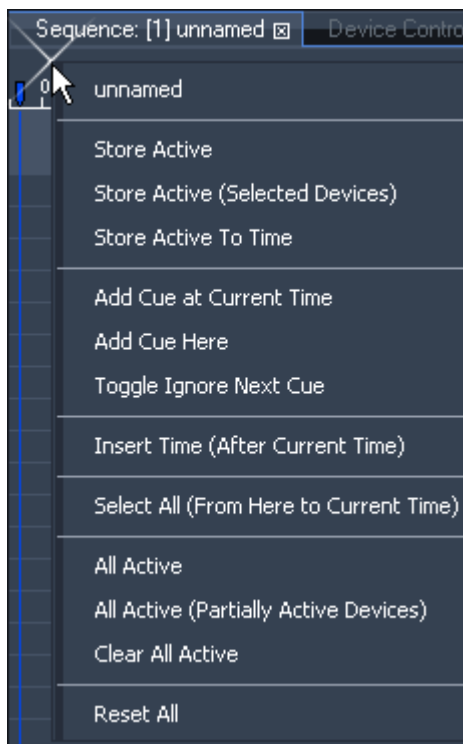

#### [Store Active]

This command stores all active values at the current time.

#### [Store Active (Selected Devices)]

In contrast to the above command, this one filters active values for those devices (layers) that are selected. The values are stored at the current time at the blue nowpointer. All active values influencing other layers will stay active.

[Store Active To Time]

A small dialog opens and asks for the time whereto all active values will be stored. The time can be entered in the format H:MM:SS:FF or shortened to SS:FF or even SFF. So, for example 3 seconds can be 0:00:03:00 or 03:00 or 300. Click Enter or the button [Ok] to close the dialog and save the active values.

[Add Cue at Current Time]

This command adds a cue at the current time, indicated by the blue nowpointer. Click onto the cue to select it and see its [properties in the Inspector tab](#)<sup>204</sup>.

[Add Cue Here]

This command adds a cue at the position of the mouse pointer. Click onto the cue to select it and see its [properties in the Inspector tab](#)<sup>204</sup>.

[Toggle Ignore Next Cue]

Click here to ignore the Next Cue in the sequence (or use CTRL+SHIFT+I) or to respect this cue again if it was set to be ignored. An ignored cue will be displayed in orange.

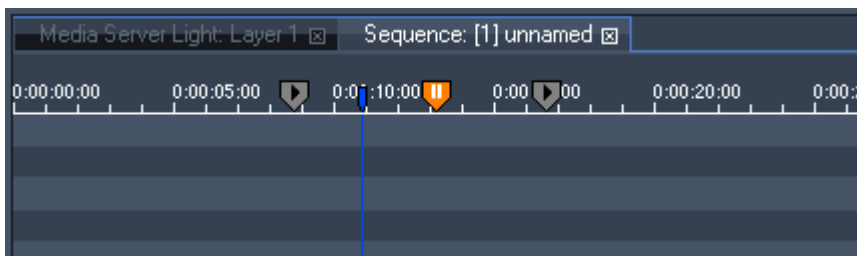

[Insert Time (After Current Time)]

A small dialog opens and asks for the time interval which will be inserted after the current time indicated by the blue now pointer. The time can be entered in the format H:MM:SS:FF or shortened to SS:FF or even SFF. So, for example 3 seconds can be 0:00:03:00 or 03:00 or 300. Click Enter or the button [Ok] to close the dialog and insert the time.

Please note that the time of the "Jump Target" of jump cues will be adjusted automatically if the target time and the jump cue are in front of the current time. In other cases the target time keeps its value.

[Select All (From Here To Current Time)]

All keys, containers and cues from the mouse pointer up to current time will be selected.

[All Active]

This command sets all parameters of all devices to active.

[All Active (Partially Active Devices)]

This command sets all parameters of partially active devices to active.

[Clear All Active]

De-activates the active status off all parameters. The values will be kept and not set back to default.

[Reset All]

Resets all parameters to their default values and removes their active status.

### 5.2.3.21.5 PROGRAMMING

This topic explains how to generate a container in the sequence and how to edit, i.e. select, move, change it. As well it shows how this can be done with keys

#### Creating containers

If you like to add containers to your timeline / sequence, you can simply drag a media file from the [Project tab](#)<sup>248</sup> onto a layer track. If there are no files in the Project tab, drag them first from the [Assets tab](#)<sup>137</sup>, or the [Thumbnails tab](#)<sup>280</sup>. You can as well drag files from an external file manager like the Windows Explorer into the Project tab or directly on the layer track.

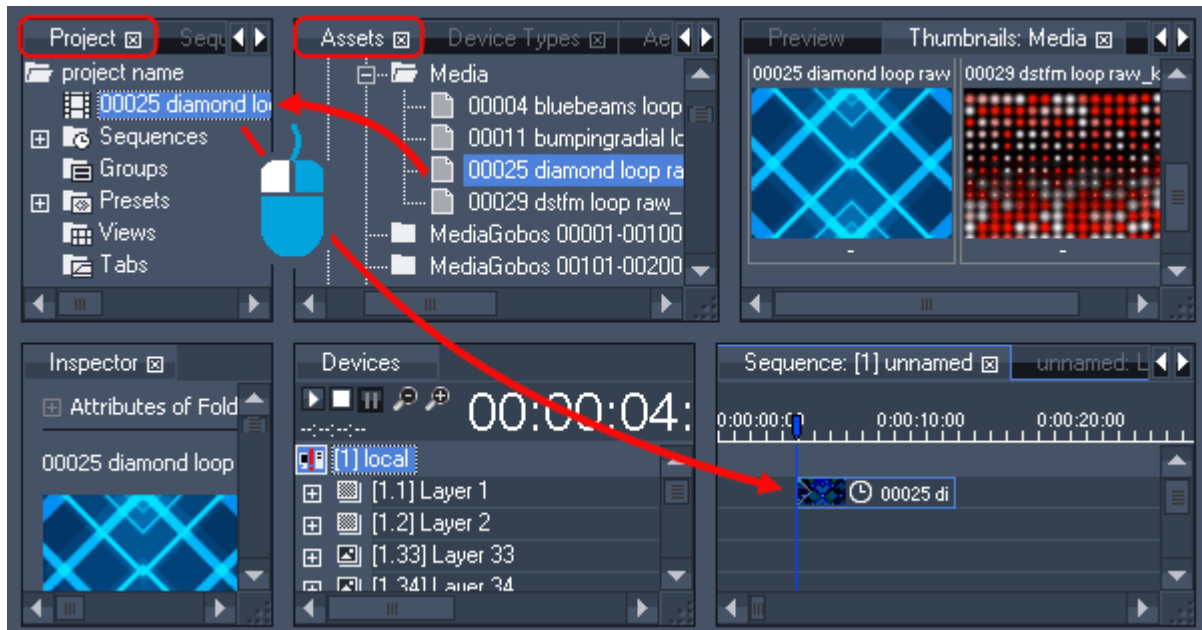

Alternatively, you can work with [active values](#)<sup>135</sup>. For example, select a layer and double-click on the media in the Project tab. Other parameters can be made active when moving the faders in the [Device Controls tab](#)<sup>164</sup>.

Once the store active command is executed, all active values are stored into the sequence at the current time (position of the nowpointer).

- use the keyboard shortcut Ctrl + Alt + S to store all values that are active
- right-click into the time bar from the sequence and choose one of the commands named "Store Active" as explained in the last chapter "[Commands](#)<sup>262</sup>"
- right-click onto a certain layer or parameter or parameter group (in the [Device Tree tab](#)<sup>168</sup>) and choose "Store Active" to store only this value

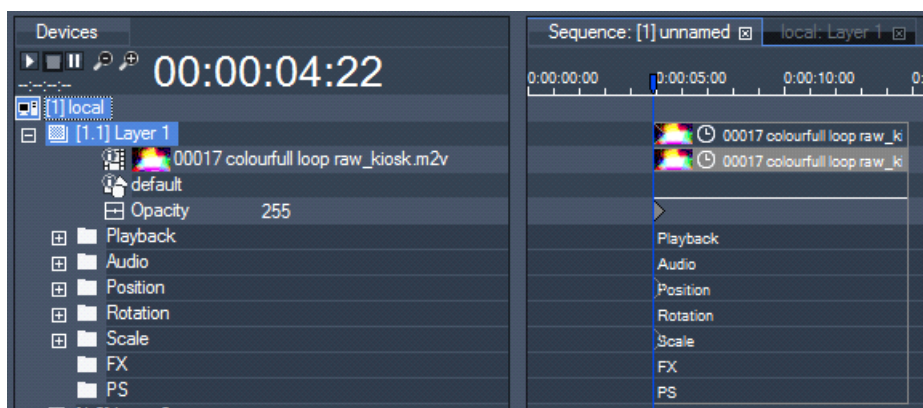



On the level of Layer 1 you see the clip summary container. Below that, there are the clip container and the keys of different parameters. Most of the parameters are integrated in subfolders (see parameter section of the respective layer type: Video Layer, Graphic Layer, Audio Tracks, Camera and Output devices). To open these subfolders click on the +-icon in front of the folder's name or just double-click on the folder.

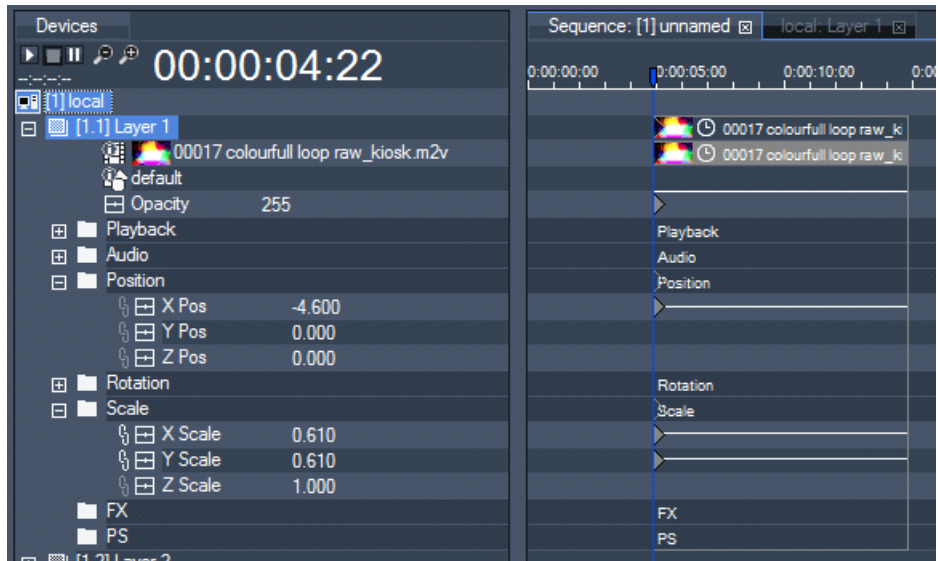

The clip including all keys is framed by the clip boundaries on the left and right edge.

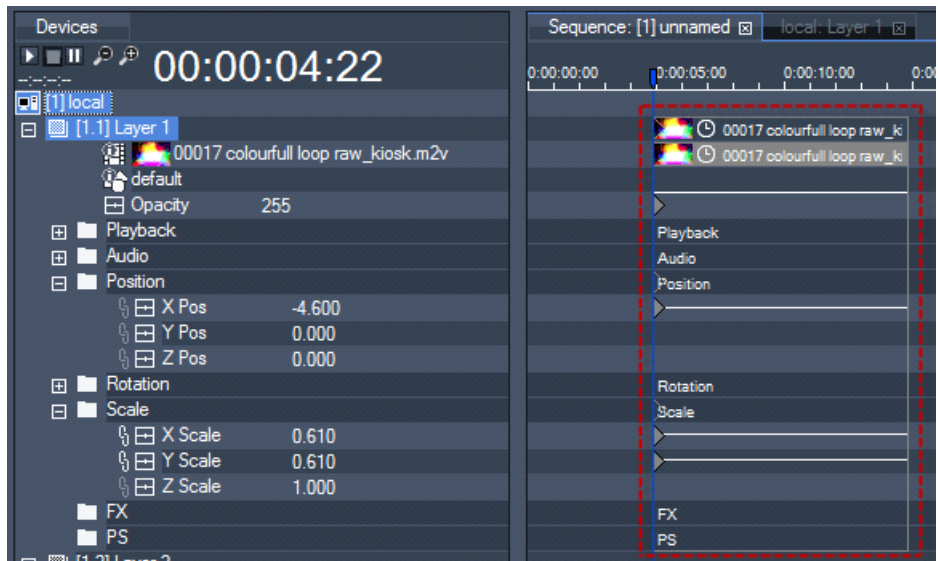

## How to select, move, copy and edit in the Sequence tab

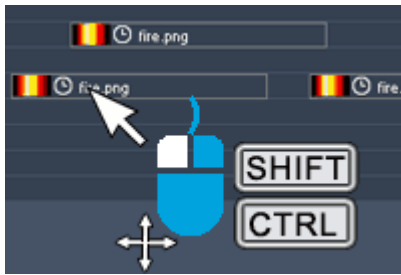

Clip containers can be positioned by selecting the summary clip container and moving it with the mouse. Moving the mouse left and right will change the container's time. Moving the mouse up and down results in shifting the container to another layer. The container changes the color to warn if it is another layer type and parameters will be discarded. If you want to make sure that the container stays on the same layer, press Shift whilst dragging the container. To copy the container, press CTRL instead of Shift.

Clip containers can be stretched in time by selecting the clip container boundaries and moving them with the mouse. You can also select it and change its value in the [clip summary inspector tab](#)<sup>201</sup>.

To select a single key, just click on it or drag a window across it. To select multiple keys, drag a window across the region of keys.

Once selected, the keys may be moved (left click and drag selection), copied (CTRL+C) and pasted (CTRL+V) within the same layer or device. To copy a key within the container boundaries drag it whilst holding CTRL.

To copy a selection of keys from one device to another, use CTRL+C to copy and CTRL+Shift+V to paste to a new selection of devices.

Please note: If copying parameters from one device to a different device, only those parameters which are shared by both devices can be copied.

To select both, cues and keys hold down the "ALT" key.

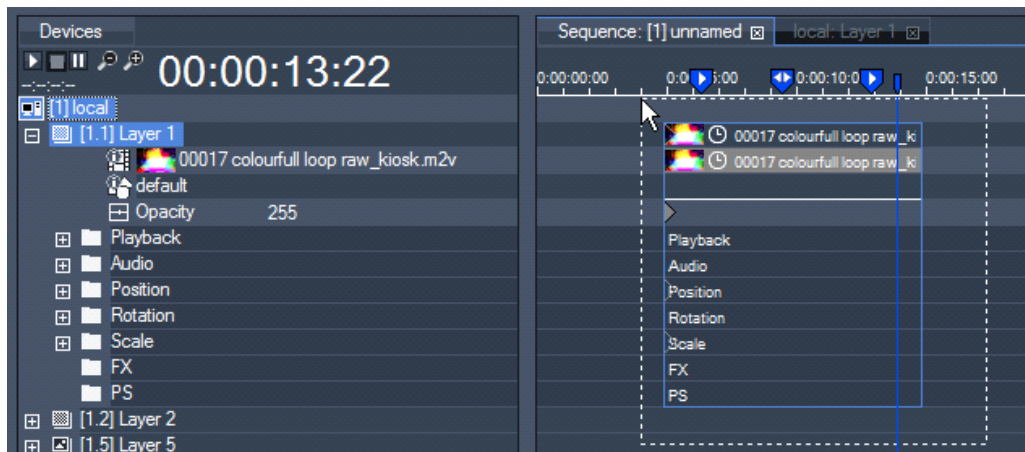

Keys can easily be added by right-clicking in the desired parameter track.



Once a key is created, you may change its value by right-clicking again on the key to access its parameter handle. You can also select it and change its value in the [key inspector tab](#)<sup>203</sup>.

To replace the content of a clip container, drag and drop the new content from the project tab onto the clip. If the new clip has a different length, you may adopt the clip container to the new media duration by right-clicking onto the clip summary container.

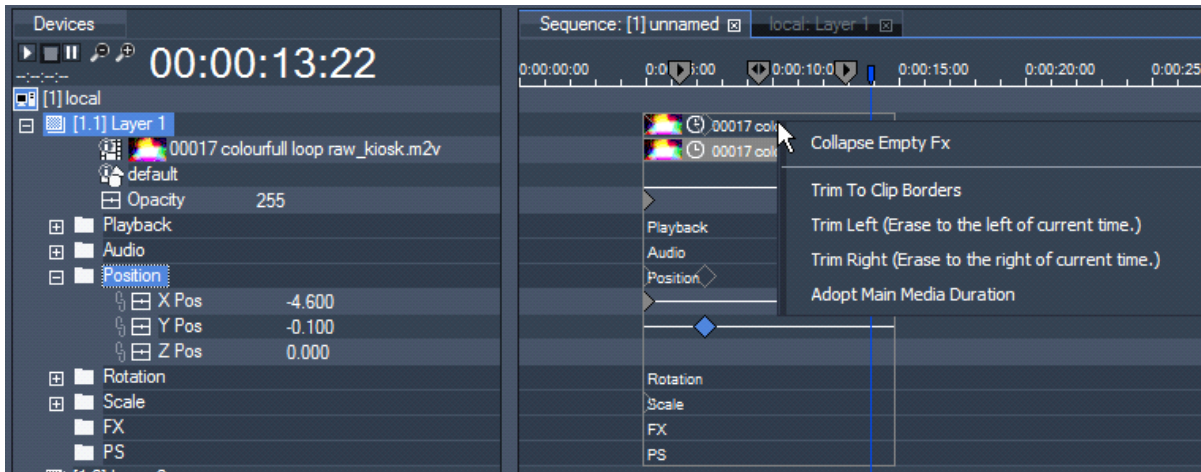

A right-click on the clip summary container gives you access to the following commands:

[Collapse Empty Fx]

When there are FX added to the layer without being used, this command collapses expanded FX subfolders.

[Trim To Clip Borders]

If a clip container was scaled down, there could be hidden keys beyond the clip borders. The command Trim To Clip Borders will remove these hidden keys and sets new keys at the left and right clip border to ensure the wanted behavior in the visible part of the clip.

[Trim Left]

This command erases everything between the nowpointer and the left clip boarder. The last key of a parameter before the nowpointer will be moved to the new clip boarder time. The video clip will now be shortened at the beginning.

[Trim Right]

This command erases everything between the nowpointer and the right clip boarder. There will be a new key set at the right clip boarder containing the value a parameter had at the nowpointer before.

[Adopt Media Duration]

This command adopts the duration of the clip if it was shortened/extended or replaced by another clip with different duration before.

**Toggle Key Mode**

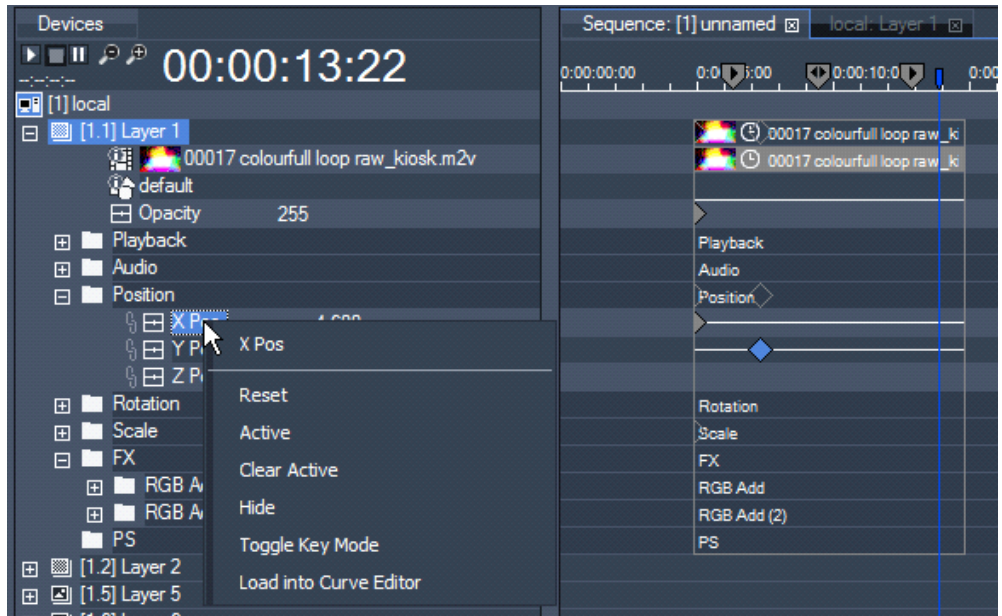

If you want a parameter value to be applied for the whole sequence and not to be set up for each single clip, take it out of the clip orientated key mode by right-clicking on the parameter and choose "Toggle Key Mode". Press OK in the upcoming pop-up window to proceed this action (this command cannot be undone!). Now the clip borders are no longer effective for this parameter.

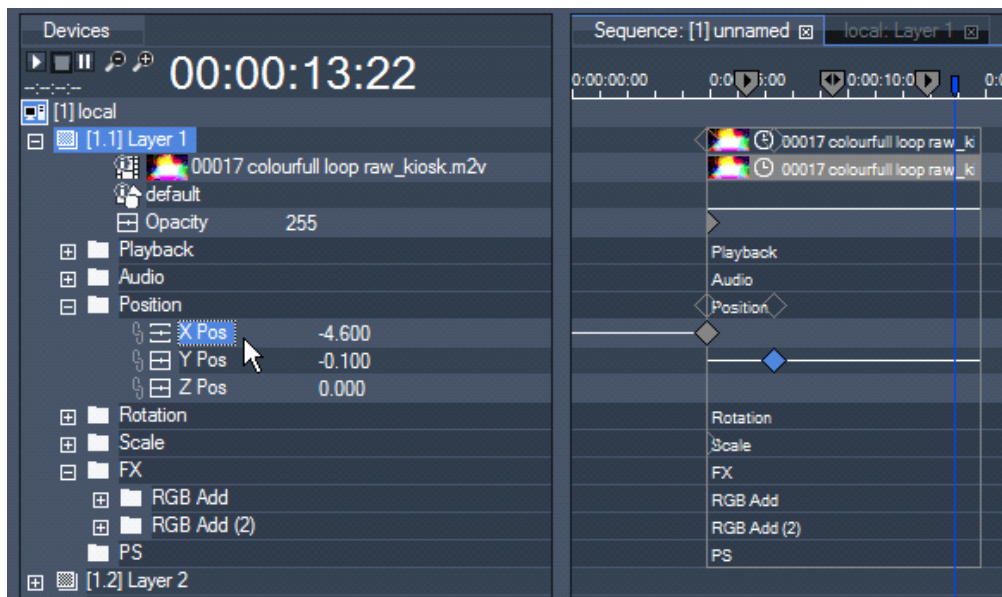

To undo steps of sequence editing press CTRL+Z on your keyboard (except for Toggle Key mode).

Please note: Changes done directly to any layer without saving these to the timeline cannot be undone!

### 5.2.3.21.6 TRACKING



- Enforce Defaults:

Choose between three states: ON, OFF and ONLY MESH / MEDIA:

In Pandora's Box timeline programming you normally determine the value of a parameter by setting a key. In some situations, however, a certain parameter may not have a key associated with it that explicitly determines its value at a certain point in time. For those situations the system can be set to "enforce defaults", i.e. to ensure that the parameter in question has the default value even though the default value is not explicitly set (by key) in the timeline.

There are two "default situations". First, the points in time in the "empty space" between clips (figure 1a). Second, the points in time to the left of the first key in a clip for a particular parameter (figure 1b). In both of these situations, there are some parameters that the system can not associate with a key.

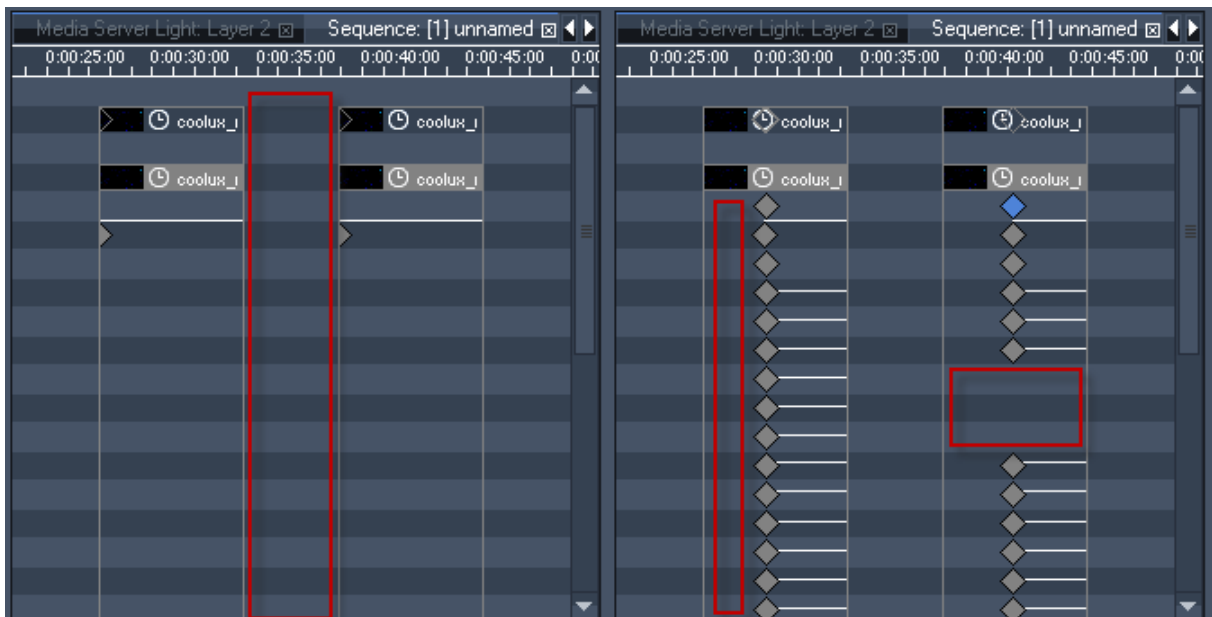

figure 1a: empty space between clips

figure 1b: left of a first key in the clip

If Enforce Defaults is ON then the system will automatically apply default values to the parameters in default situations. This behavior ensures that each frame in the timeline is associated with exactly one definite state for all parameters. So if you click into the timeline at TC 0:00:09:00, for example, then jump to other places in the timeline and return to TC 0:00:09:00 later, the output will be exactly the same as before at TC 0:00:09:00, even though you may not have explicitly set values for all the parameters.

If Enforce Defaults is OFF then the system does not apply defaults in the situations described above. Rather, the parameters retain whichever value was set before the situation was encountered. This means that the state associated with a particular frame in the timeline depends on two things.

All parameters which have explicitly set keys are changed to reflect those keys. The values of the remaining parameters, however, are not changed at all (since defaults are not being enforced). The state of the output therefore depends in part on how the parameters for which no keys were explicitly set were edited before.

To see this, take a look at figures 2, 3a and 3b. At the beginning of the first clip, the scale of the object is explicitly set by a key.

Imagine the timeline is started at TC 0:00:09:00 and runs on until it is paused at TC 0:00:18:00.

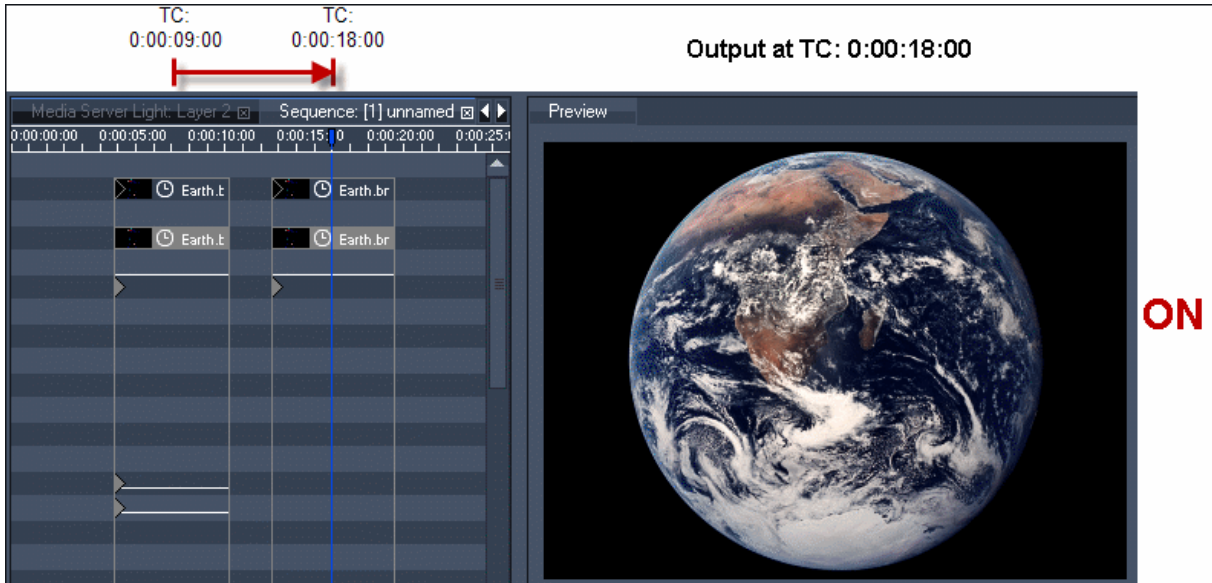

figure 2: Enforce Defaults is set to ON

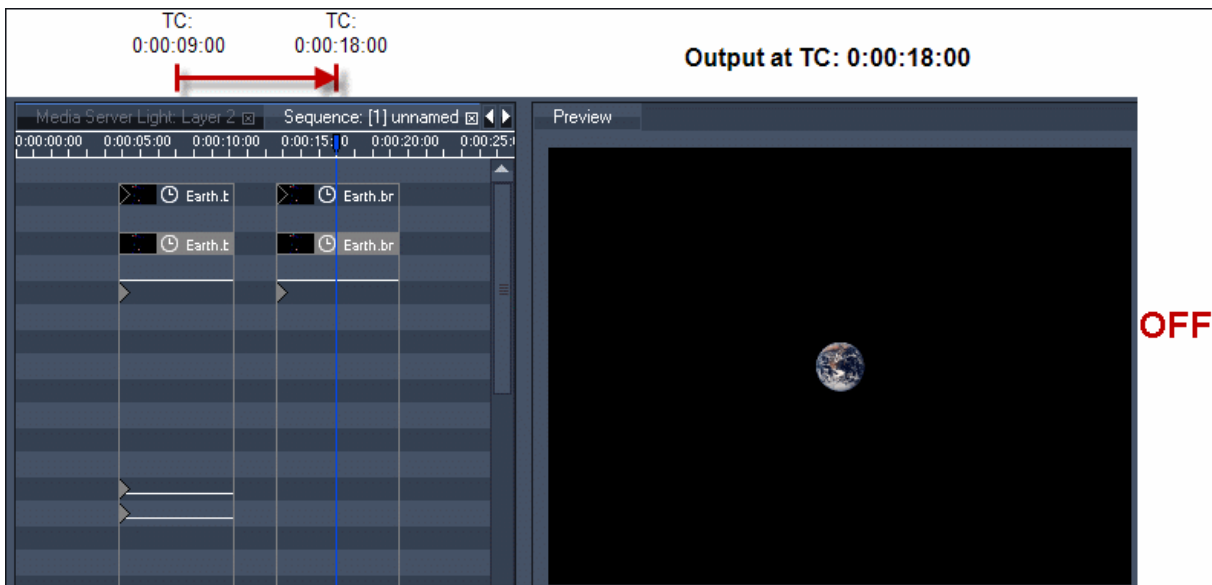

figure 3a: Enforce Defaults is set to OFF; the scaling keys of the first clip have very low values

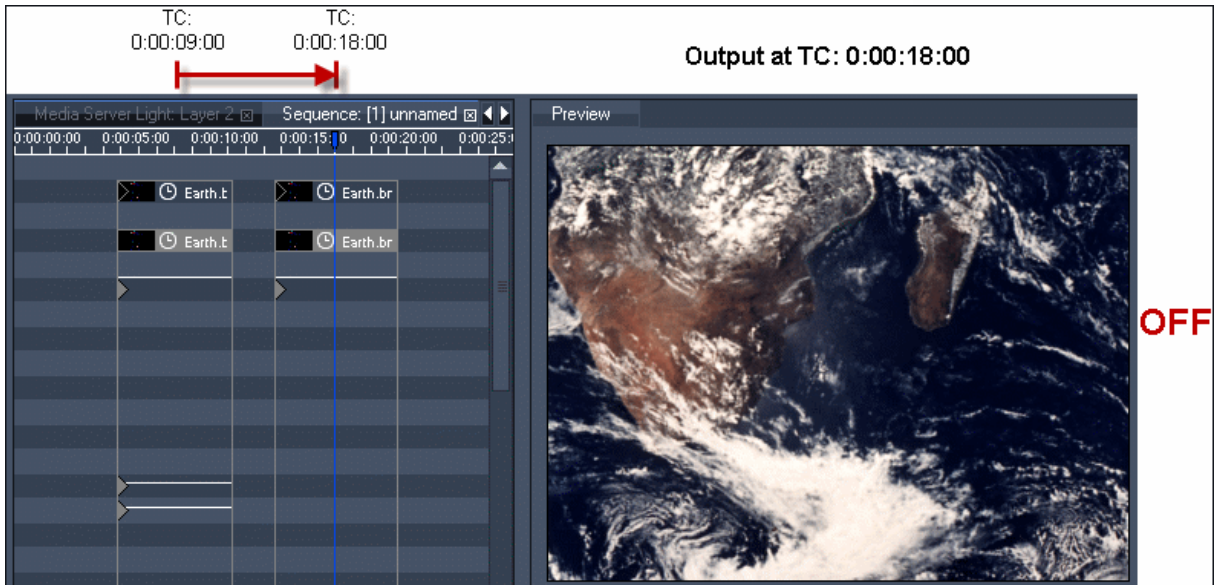

figure 3b: Enforce Defaults is set to OFF; the scaling keys of the first clip have very high values

The state of the output when Enforce Defaults is OFF is "path dependent" in the sense that it depends on the "path" you take to reach a particular timeline frame. When Enforce Defaults is ON it is "path independent" in that the output state depends only on the frame that you are in.

Take a look at figure 4 and 5 for an example of path dependency when Enforce Defaults is set to OFF. Consider a user clicking in the timeline at the different timecodes.

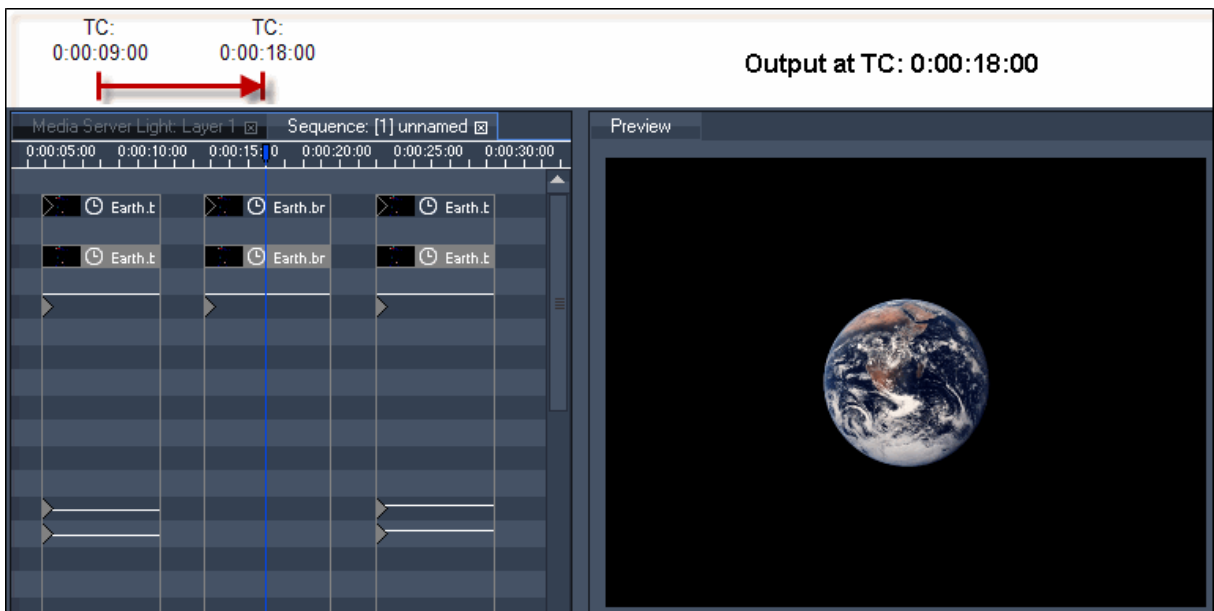

figure 4: Enforce Defaults is set to OFF.

Jumping from TC 0:00:09:00 (low values for object scale) to TC 0:00:18:00 (no scaling values) results in an object that is scaled very small.

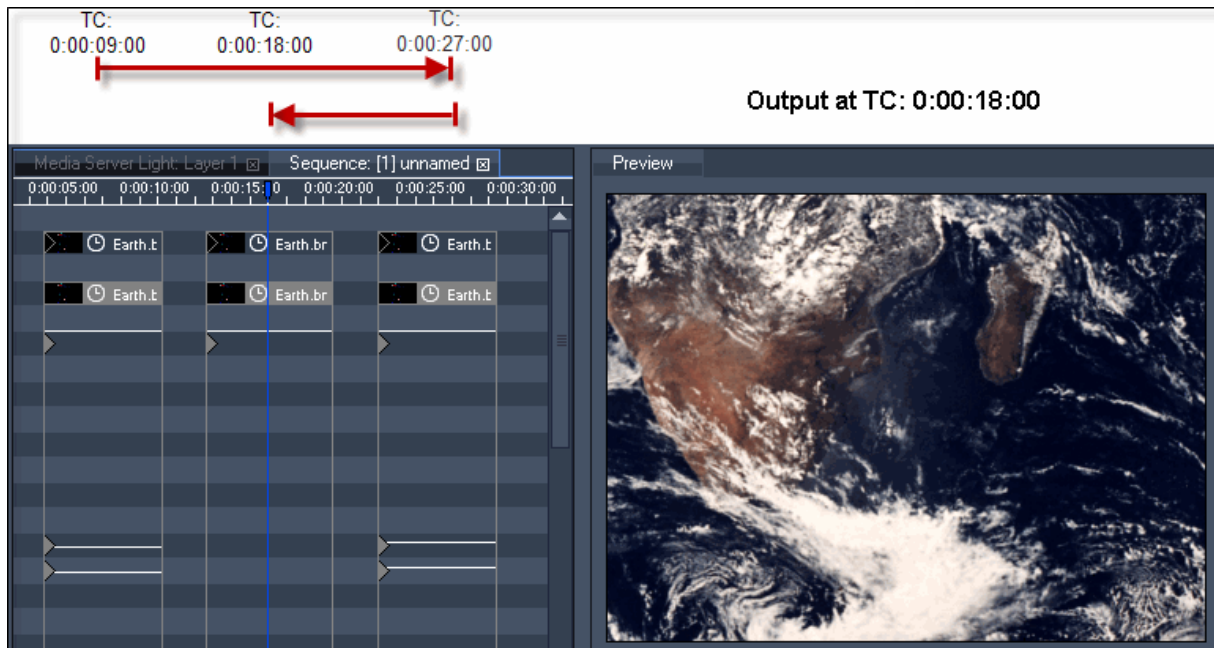

figure 5: Enforce Defaults is set to OFF

Jumping from TC 0:00:09:00 (low values for object scale) over TC 0:00:27:00 (high values for object scale) to TC 0:00:18:00 (no values for object scale) results in an object that is scaled very high.

Path independence means that leaving Enforce Defaults set to ON is usually a good idea, especially when working with a single timeline, since it helps you make sure that each frame in the timeline leads to exactly the result you want it to. When working with multiple timelines, however, you may want to use one timeline to control certain parameters of a device while using a different timeline to control other parameters of the same device. In this and similar scenarios, it is necessary for each timeline to only apply those values that are explicitly set in it via keys. This gives the other timelines the needed "space" to apply the values determined by their keys.

In these cases, setting Enforce Defaults to OFF makes sure that each timeline yields as much as possible to other timelines.

Note that you can use the inspector of a media or mesh assignment key to set the value of the key to "none". This allows you to unload mesh or media from layers even when Enforce Defaults is set to OFF by explicitly applying the default value ("none") via a key.

The setting ONLY MESH / MEDIA combines aspects of both of the other two Enforce Defaults modes. When it is set defaults are automatically applied to the mesh and media parameters. All other parameters besides mesh and media are not changed at all in the default situations.



### 5.2.3.22 SEQUENCE CONTROL

Use the sequence control tab to monitor the status of available sequences.

All created sequences in the project's sequence folder are displayed in the sequence control tab.

The sequence taper shows the following information:

- ID and name of the sequence
- the percentage value of the sequence opacity
- timecode of the nowpointer's position
- current play mode (play, pause or stop)



If the sequences opacity is set to zero, the sequence taper background will turn red:



By clicking on a sequence item in the sequence control tab you may set the selected sequence to Play or Pause.

To create a new sequence you may right-click in any empty region of the sequence control tab. The newly created sequence will automatically be loaded into the Timeline Tab.

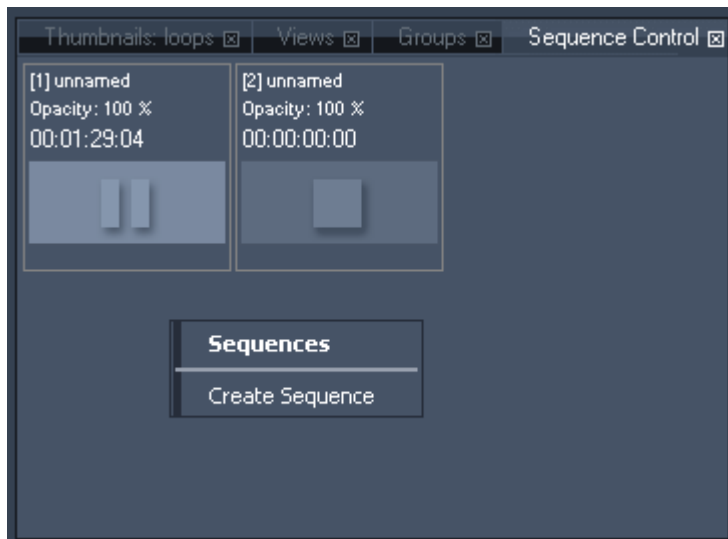

Once a sequence is shown in the sequence control tab, you may right-click on the sequence item at any time and choose one of the following available commands:

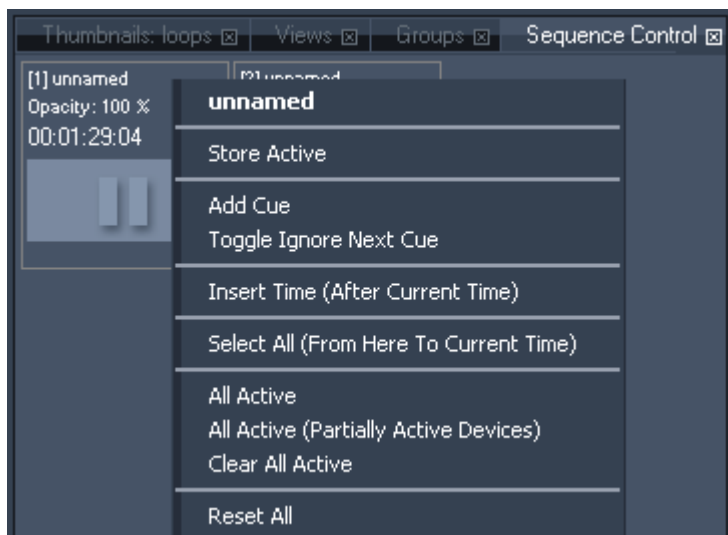

- Store Active

This command stores all active values at the current time.

- Add Cue

Adds a Cue at the position of the mouse pointer. See the [Cue Inspector](#)<sup>204</sup> for further information. Please note: it is recommended to have a spacing of at least 10 frames in between two cues.

- Toggle Ignore Next Cue

Click here to ignore the Next Cue in the timeline (or use CTRL+SHIFT+I) or to respect this cue again if it was set to be ignored.

- Insert Time (After Current Time)

Enter the amount of seconds that will be inserted after current time.

- Select All (From Here To Current Time)

All keys, containers and cues from the mouse pointer up to current time will be selected.

- All Active

This command sets all parameters of all devices to active.

- All Active (Partially Active Devices)

This command sets all parameters of partially active devices to active.

- Clear All Active

This command clears all active parameters.

- Reset All

This command resets all active values.

### 5.2.3.23 TASKMANAGER

To open the taskmanager tab, navigate to Tabs - Taskmanager or press CTRL+SHIFT+M on your keyboard.

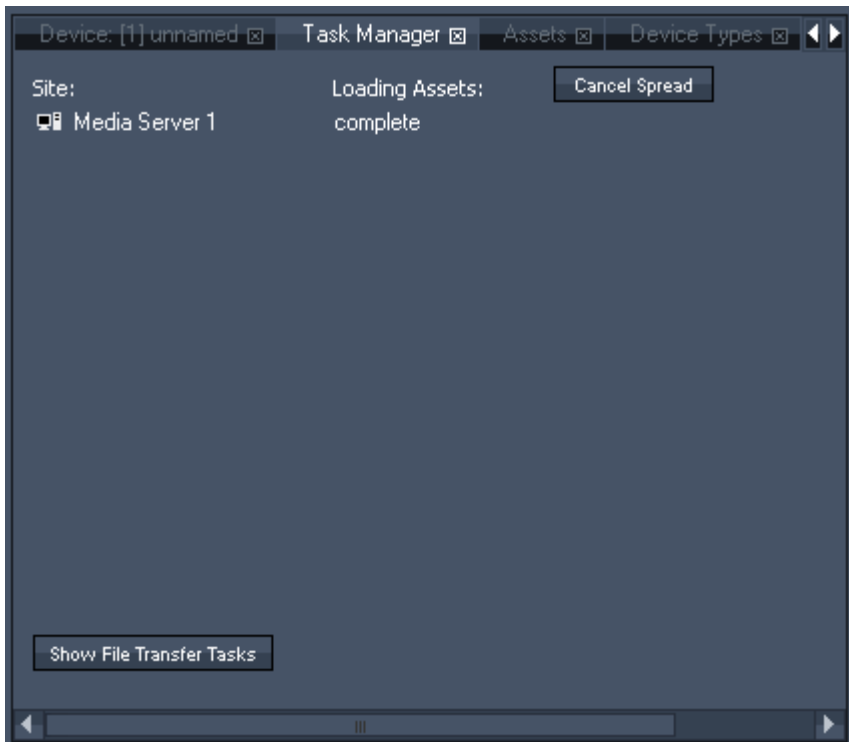

The taskmanager lets you monitor if a site is still loading files and if all file send and receive actions that were initiated by a file or folder spread process.

If you click on Show File Transfer Tasks, you will get a list with the status of all file transfers.

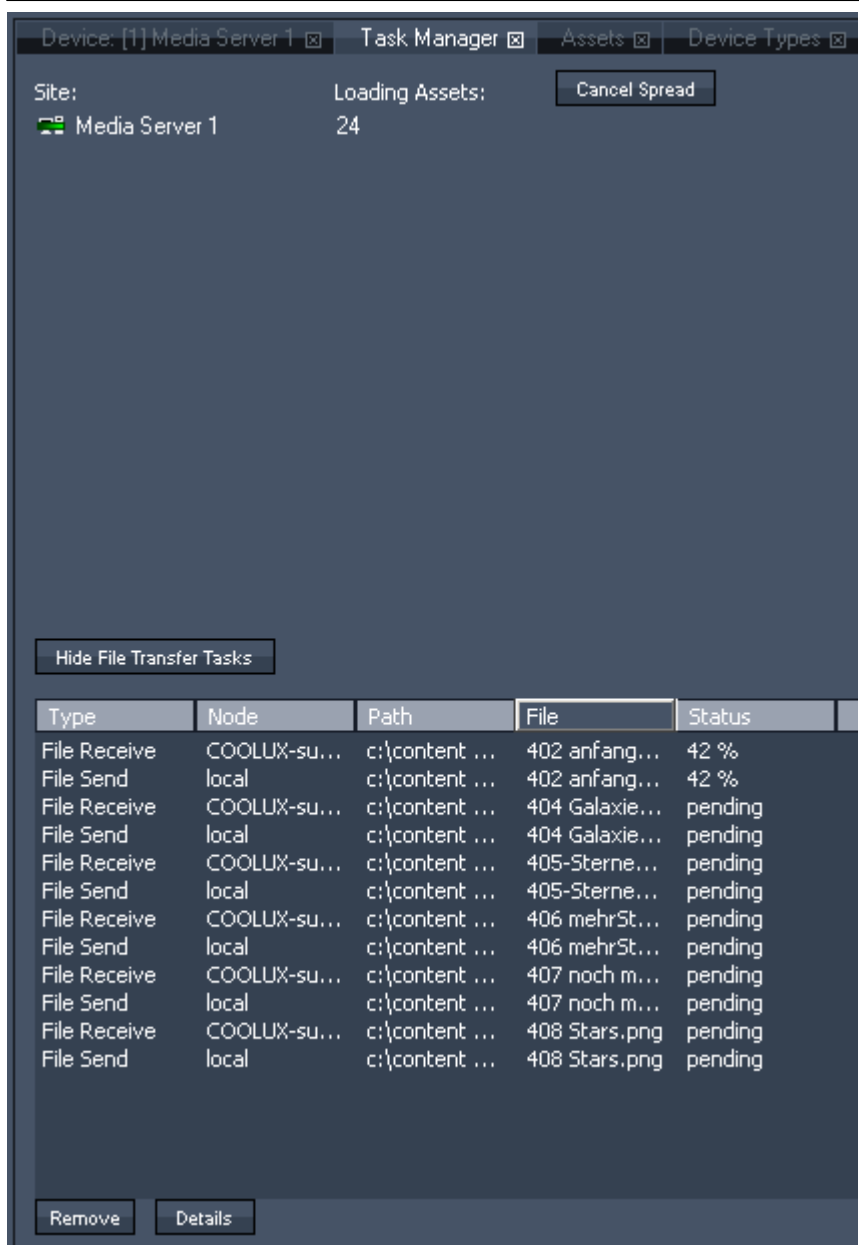

The site icon with a green stripe indicates that the site is still active receiving or loading assets. The same icon will also be shown in the Devices Tab.

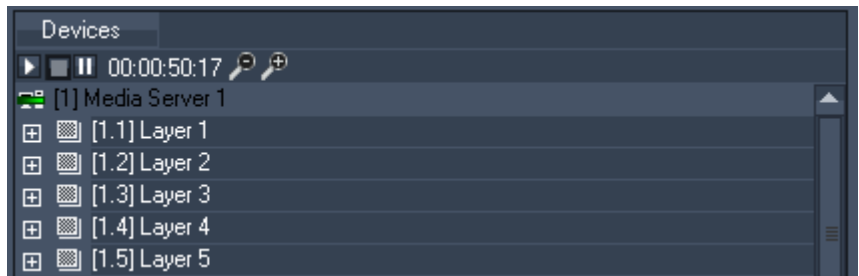

The number of assets to load is shown next to the site name in the taskmanager. As soon as the loading process is done "complete" will be displayed and the site icon turns back to the normal one.

Clicking on [Cancel Spread] will cancel the spreading process.

If you encounter any network problems or issues of spreading files, individual items may be selected from the list and removed to continue with other spread operations.

If you encounter issues that you cannot solve yourself by removing and/or restarting the project, please collect the "details" description of the task that is causing the issue and report it to [support@coolux.de](mailto:support@coolux.de).

### 5.2.3.24 TEXT INPUT EDITOR

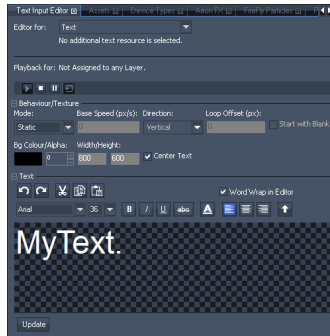

Create your Text Input by right-clicking on a folder in the [Project tab](#)<sup>248</sup> > Add Text Input. Select it to see its properties in the [Text Inspector](#)<sup>197</sup>. It also offers the button "Open in Resource Editor" which opens the tab "Text Input Editor". Alternatively, you can click on 'Tabs' in the Toolbar > Text Input Editor.

In the Text Input Editor you may set up all options regarding the content of the selected Text Input. It also allows to transfer style properties to other Text Inputs.

Please note, that .net framework 4.0 is needed to display this tab.

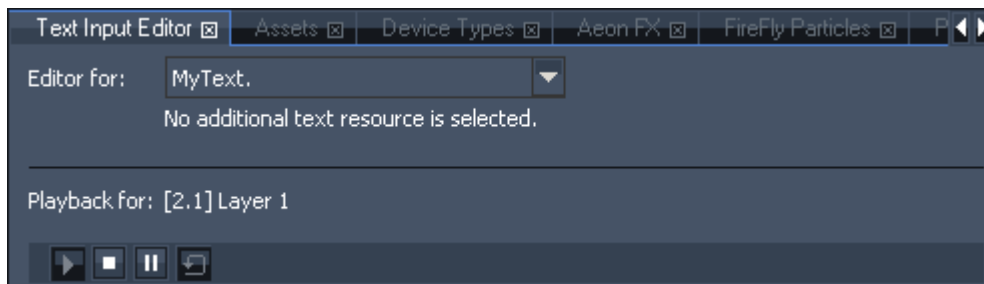

At the top of the depicted Editor you see in the drop-down list that only one Resource named "MyText." is selected. If multiple Text Inputs were selected, the section "Behavior / Texture" applies to all of them. Afterwards, it is displayed, that the according Text Input is assigned to the first Video Layer of the second Site and that the [Playback command](#)<sup>302</sup> (from the Layer) is set to Play Loop. The playback is needed when the Text Mode is set to Scrolling or Streaming and the container is changed from [Lock To Time](#)<sup>202</sup> to free run mode. If the container is locked to time, and the sequence is playing, the text will "play", i.e. move also. Mind that playing back is only possible on Video Layers. If you like to use scrolling text on a Graphic Layer, please use the Aeon FX "[UV Scroll](#)<sup>565</sup>".

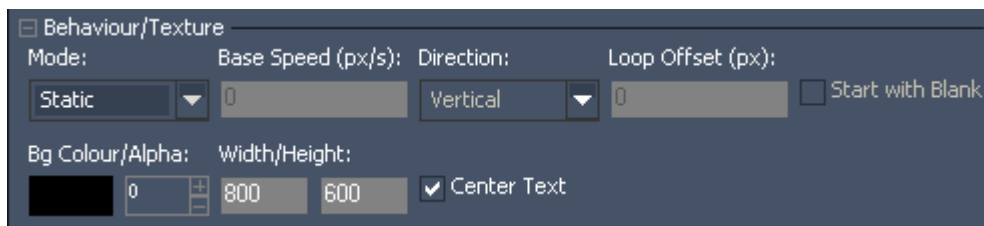

- Mode
- Static

Your text is displayed on a fixed position according to the Layer's Position parameters.

- Scrolling and Streaming

Your text will move according to the following parameters.

For the Scrolling Mode, you enter text, click "Update" and instantly the entire text will be displayed as scrolling text. Depending on the playback mode, the text will scroll once or endlessly. The old text will be kept in the Editor window. If you like to show new text, enter it and press "Update". In case, your text is scrolling endlessly (Play Loop) the old text will change abruptly to the new one.

For the Streaming Mode, you enter text, click "Commit" and after a couple of seconds, your entire text will scroll once through the window. Note, that it cannot scroll endlessly. The old text will be deleted from the Editor window. As soon as you enter new text and click "Commit", it stands in a pending line. Only when the old text has moved out of the window, the new one can be displayed. This means on the one hand that you can commit unlimited text entries and PB takes care, that one follows the other. This is done by rendering multiple textures at the same time. Which also means on the other hand, that textures can be empty if now pending text is available. This explains why you have to wait for the duration of one texture width / height before recently committed text becomes visible. If you like to clear pending text click the "Pending" button underneath the Editor. If you like to clear pending text and the one currently displayed, click "All".

Please note that Widget Designer can send text to a Pandoras Box Text Input regardless from its mode. You can use the [Text Input control](#)<sup>951</sup> or the [PB Text Output node](#)<sup>1125</sup>.

- Base Speed

Enter the speed for Scrolling and Streaming text. It is measured in pixel per second. When entering negative numbers the direction will be reversed.

- Direction

Choose how Scrolling and Streaming text should move: "Horizontal" for right-left movement and "Vertical" for down-up. Note that the direction can be reversed with a negative Base Speed.

Loop Offset

Influence whether Scrolling and Streaming text should have an offset, i.e. blank space before the start of a new text entry.

Start with Blank

Decide whether Scrolling text should start with blank space before its first letter. Use the option "Offset

BG Color / Alpha

Choose a background color (for all text modes) and its opacity (0 = transparent)

Width / Height

Set up how large the texture for a text entry should be. Note that this influences the Base Speed and Font Size. The larger the Font Size the smoother font edges look and the larger the texture needs to be.

Center Text

This centers Static Text vertically.

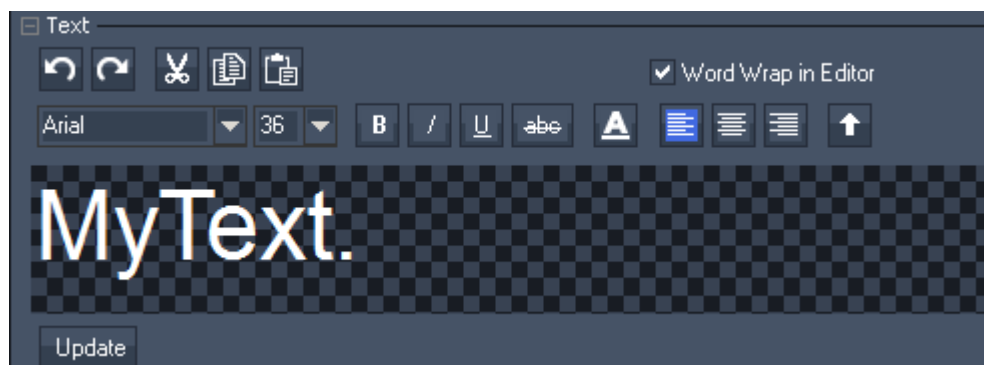

**MyText.** Enter your text into the Editor. If you have chosen a Static or Scrolling text, click "Update" to display your changes. In case you are working with a Streaming text, click "Commit". See above explanation for further detail.



Undo your last steps or Redo undone ones.



Cut or Copy selected text and Insert it with the last button. CTRL+A selects all text in the Editor.

"Word Wrap in Editor" creates a new line if your text is longer than one line in the Editor.



Choose a Font and the Font Size for selected text. Note that the Font Size also depends on the texture width/height.



Choose a Font Style for selected text: Bold, Italic, Underlined, Strike through, Font Color (opens a Color dialog)



Align Left, Align Center and Align Right are used to position your text in regards to the texture width.

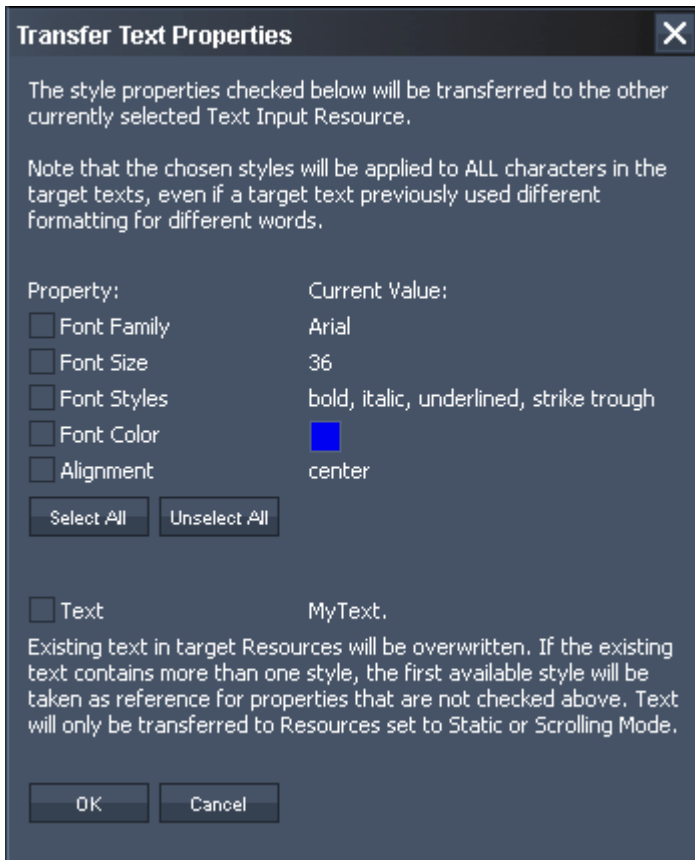

The last button  opens the "Transfer Text Properties dialog".

In case you have selected multiple Text Inputs in the Project tab, you can choose with the drop-down list (at the very top) which text is the "master" or "source". Per default, all "Text" options apply only to the master text. With this dialog however, you can choose to transfer the current options to all other selected Text Inputs too. In case you have set up more than one style in your master text, only the first one can be transferred.

Select which property you like to copy and press "Ok".

If you like to create multiple copies of your current Text Input, please right-click on it in the Project tab and choose "Clone".

### 5.2.3.25 THUMBNAIL VIEWER

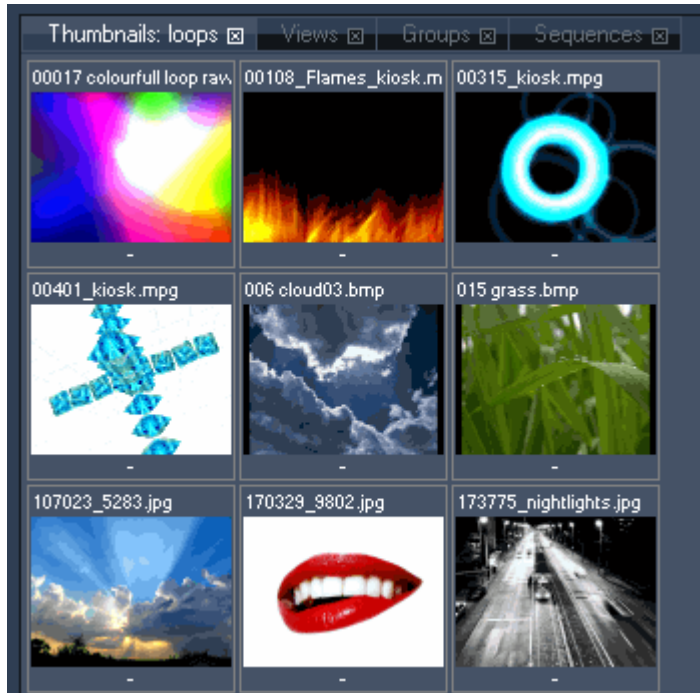

The thumbnail viewer is context sensitive and depends on either an asset browser folder to be viewed or a project tab folder entry to be viewed.

The thumbnail viewer displays both 2D and 3D media.

Please note:

The 3D media is displayed with a default texture to identify the UV mapping orientation.

All video thumbnails will display a frame from the middle of the video. They do not show the first frame.

When used with the project tab and selected devices such as layers or cameras, you may double click on any thumbnail to assign it to the current selection of devices.

Please be aware that all thumbnail images are stored locally. If the media is not present on all clients you may have to spread the media to all clients in order to assign it to the selected devices.



### 5.2.3.26 VIDEO EXPORT

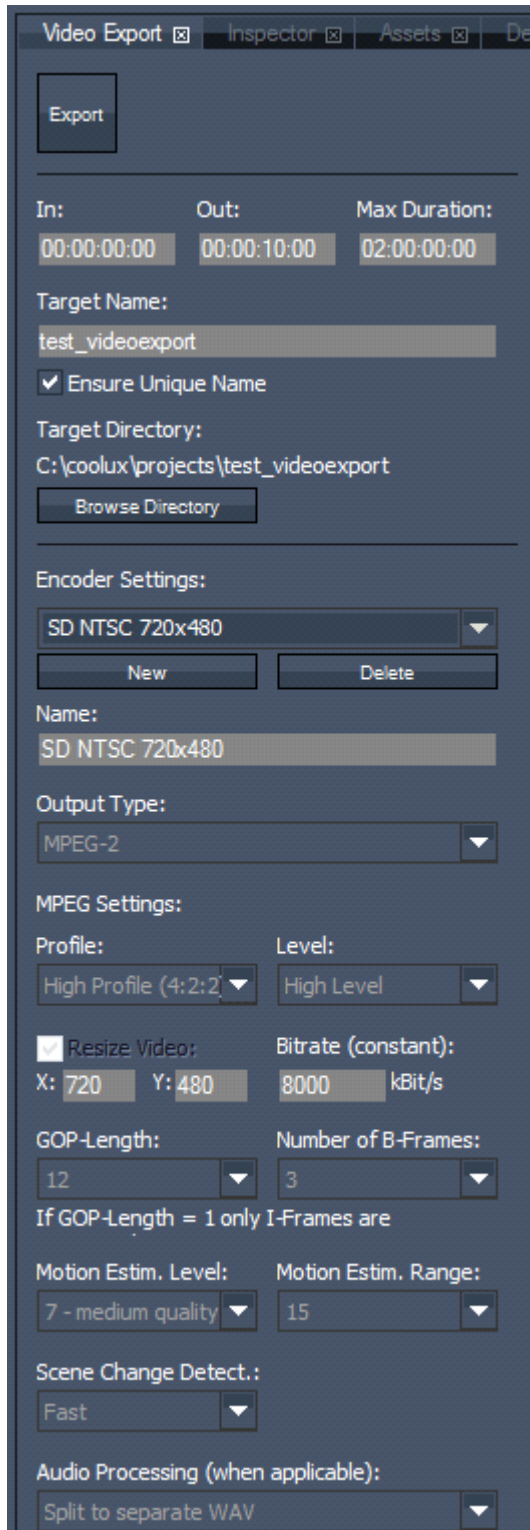

To open the Video Export Tab, please click on 'Tabs' in the Toolbar - Video Export. Please note that the Video Export feature is limited to Manager editions and requires the Encoding option.

The video export tab allows you to define all settings for exporting a video from a sequence.

Set the [preview tab](#)<sup>232</sup> to preview the specific output that should be exported. Note that not the preview itself is exported. It is rather the image the camera sees, not the one from the output. As a result all changes made in the output are not included in the exported video. That includes effects on the output layer and parameters like softedge and keystoneing.

If you like to change the aspect ratio of the exported video select a camera layer and change the [camera aspect ratio](#)<sup>214</sup>.

If you like to change the resolution of the exported video make the according changes in the encoding settings. If you export an uncompressed image sequence the resolution is adopted automatically to the current screen resolution the local system is set to.

Please note that incoming active values will be ignored, e.g. Widget Designer and Art-Net data. This is because the export is not running in real time, thus the incoming data cannot be allocated to a specific frame. Same applies to containers that are not [locked to the timeline](#)<sup>202</sup>. Free-run containers behave differently than during normal play back as the time reference is missing.

The Export feature is designed to work with mpeg-2 videos, images and ASIO wav tracks. Exporting other formats such as \*.mov and \*.avi might lead to unexpected behavior. Please see the [File Inspector](#)<sup>190</sup> for adjusting colorspace settings.

Also [encrypted media](#)<sup>216</sup> cannot be exported. On the other hand you may encrypt your exported video afterwards.

[Export]:  
Click [Export] to start the video export. Please note that the user interface is locked while the export is in process. To abort the export, press the shortcut [CTRL + Q]. Please note that the video export won't be done in real-time. The higher the quality and resolution set in the encoder the export will take a longer time to be finished.

[In]:  
Define the timecode at which the export should start in the format hh:mm:ss:ff.

[Out]:  
Define the timecode at which the export should end in the format hh:mm:ss:ff.

[Max. Duration]:  
You may define the maximum duration of the exported video file in the format hh:mm:ss:ff. By default the max. duration is set to 2 hours.  
Example: Having the inpoint set to 00:00:00:00 and the output set to 03:00:00:00, the video export will stop after 2 hours.

[Target Name]:  
Enter the name for the video file you are going to export.  
By default the video will be named "Project name'\_video".  
If the option "Ensure Unique Name" is checked, the video file will be enumerated serially if the chosen name already exists.

[Target Directory]:  
By default the video will be saved to the directory of your project file. Click [Browse Directory] to browse to a new directory if you want to change this path.

[Encoder Settings]:  
In this section you may choose the settings of the file you're going to export.  
There are several predefined profiles:

Profile Name	Output Type	Mpeg Settings		Resolution, px	Bitrate (constant), kbit/s	Audio Processing
		Profile	Level			
SD NTSC 720x480	MPEG-2	High	High	720x480	8000	separate wav
SD PAL 768x576	MPEG-2	High	High	720x576	8000	separate wav
XGA 1024x768	MPEG-2	High	High	1024x768	10000	separate wav
HD 1280x720	MPEG-2	High	High	1280x720	12000	separate wav
HD 1408x1056	MPEG-2	High	High	1408x1056	15000	separate wav
HD 1920x1080	MPEG-2	High	High	1920x1080	20000	separate wav
2048x1080	MPEG-2	High	MXL	2048x1080	80000	separate wav
4080x2160	MPEG-2	High	MXL	4080x2160	80000	separate wav
Uncompressed	Uncompressed Frame Images (.png)		Computer's resolution		none	

These profiles are not editable. You may choose one of these profiles from the drop-down list or create a new profile by clicking on [New].

[New]:  
Click [New] to create a custom encoding profile and name it.

[Output Type]:  
Choose between MPEG-1, MPEG-2 and an image format to export an image sequence.  
When using MPEG-1 or MPEG-2 go on with the MPEG settings. Pandoras Box Encoder allows to encode files larger than 1080p to our proprietary .mxl format. The maximum resolution is 4094 x 2800 px, though it is recommend set 4080 x 2800 px as this conforms with the mpeg standard. The encoding process depends on available graphic card RAM.

If you like to export an image sequence, you may choose between three image formats: png as an lossless compression format, bmp as an uncompressed format and dds as an lossy compression format. For more information please see the chapter "[Image Sequences](#)"<sup>[99]</sup>.  
 Now, simply enter the resolution for the final image sequence and tick the "Export Alpha" check box if you need transparent image parts. Adjust the audio processing as described below.

[Profile]

Set the MPEG Profile and Level.

Please note that you will need High Profile (Profile 4:2:2) and High Level for HD 1920x1080 px resolution. The Level automatically changes to MXL if you encode files to a format bigger than 1920 x 1080 px.

[Resize Video]:

As long this option is not checked the video resolution will have the size of your windows desktop. Check [Resize Video] and insert a custom resolution for X and Y (in px) if necessary.

[Bitrate (constant)]:

Choose the bitrate (in kbit/s). Recommended are about 8.000 kbit/s for SD and 20.000 or higher for HD.

[GOP-Length]:

The length of the Group Of Pictures is editable from 1 to 100. The higher the GOP-Length the better the compression rate gets at the expense of quality. GOP set to 1 will use I-frames only.

[Number of B-Frames]:

Choose a value between 0 and 7.

[Motion Estimation Level]:

Set a value between 0 (no motion search) and 15 (high quality). The higher the value, the better the quality, the longer the encoding process.

[Motion Estimation Range]:

Set a value between 0 (no motion search) and 15 (high quality).

[Scene Change Detection]:

Choose between None, Fast and Refined.

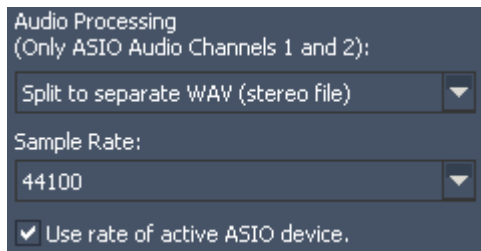

[Audio Processing]:

Please note that only the first and second ASIO channel are processed.

Choose between the options to...

- discard the audio information, it is simply not present in the resulting export files

- split to separate WAV (stereo file) to render one wav file with two channels; the file is created in the same export

folder

- split to separate WAV (mono files) to render two wav files each with one channel; the files are created in the same export folder

- include the audio as a audio track; this is only possible for mpeg videos. Please see further information and why it is sometimes not recommended to include audio tracks in the [mpeg format](#)<sup>[102]</sup>.

### 5.2.3.27 VIDEO RECORDING

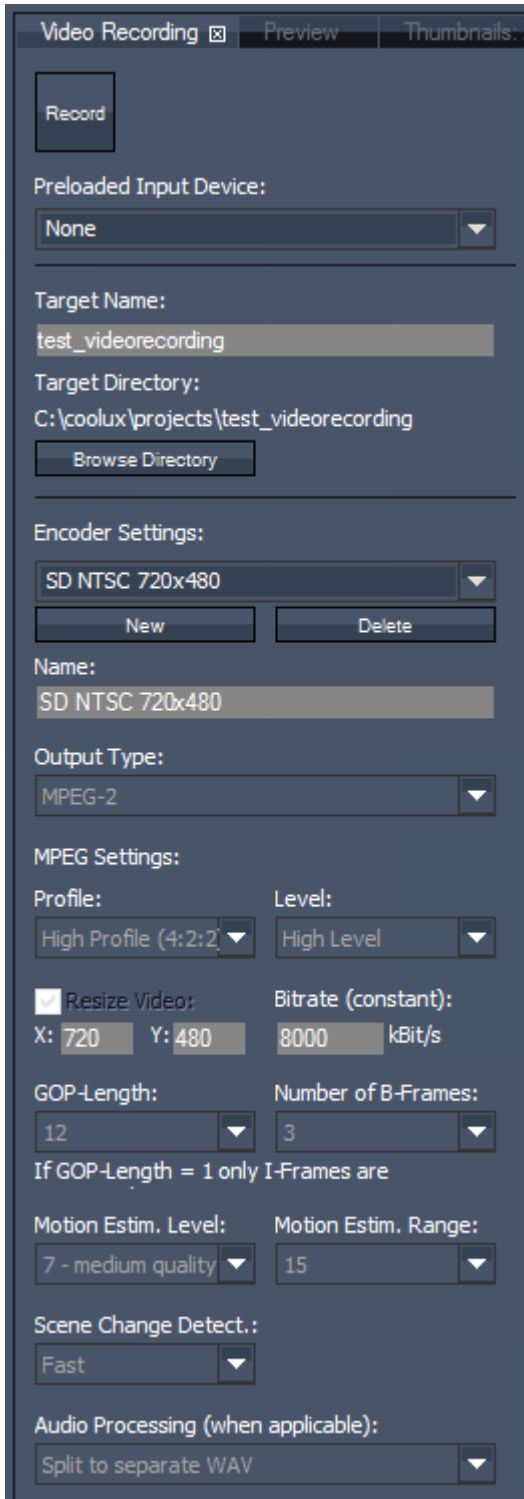

The Video and Audio Recording tab allows you to define all settings for recording a local video and / or audio live input source. Please note, that the recording tab is only available in the master interface, and that the feature is restricted to local inputs excluding remote inputs from clients.

**Record:**  
Click the "Record" button to start the video and audio recording. Press this button again to stop the recording.

**Video / Audio Input:**  
Choose the video and audio source you would like to record. Note that these sources must be added to the project first.

**Limit Record Duration:**  
Enable this function and enter a time when you would like to record the sources for a defined time.

**Target Name:**  
Enter the name for the video file you are going to record. By default the video will be named "Project name'\_video".  
Please note: if the file name already exists and you start a new recording with the same name, the existing file will be overwritten without warning.

**[Target Directory]:**  
By default the video will be saved to the directory of your project file. Click [Browse Directory] to browse to a new directory if you want to change this path.

**[Encoder Settings]:**  
In this section you may choose the settings of the file you're going to record.

There are several predefined profiles:

Profile Name	Output Type	Mpeg Settings		Resolution, px	Bitrate (constant), kbit/s	Audio Processing
		Profile	Level			
SD NTSC 720x480	MPEG-2	High	High	720x480	8000	separate wav
SD PAL 768x576	MPEG-2	High	High	720x576	8000	separate wav
XGA 1024x768	MPEG-2	High	High	1024x768	10000	separate wav
HD 1280x720	MPEG-2	High	High	1280x720	12000	separate wav
HD 1408x1056	MPEG-2	High	High	1408x1056	15000	separate wav
HD 1920x1080	MPEG-2	High	High	1920x1080	20000	separate wav
2048x1080	MPEG-2	High	MXL	2048x1080	80000	separate wav
4080x2160	MPEG-2	High	MXL	4080x2160	80000	separate wav
Uncompressed	Uncompressed Frame Images (.png)			Computer's resolution		none

These profiles are not editable. You may choose one of these profiles from the drop-down list or create a new profile by clicking on [New].

**[New]:**

Click [New] to create a custom encoding profile and name it.

**[Output Type]:**

Choose between MPEG-1, MPEG-2 and Uncompressed.

When using MPEG-1 or MPEG-2 go on with the MPEG settings.

Using the uncompressed output type there is nothing more to set up. This output type will render uncompressed frame images (.png) in the resolution your local computer is set to. There will be no audio processing.

**[Profile]:**

Set the MPEG Profile and Level.

Please note that you will need High Profile (Profile 4:2:2) and High Level for HD 1920x1080 px resolution. The Level automatically changes to MXL if you encode files to a format bigger than 1920 x 1080 px.

**[Resize Video]:**

As long this option is not checked the video resolution will have the size of your windows desktop.

Check [Resize Video] and insert a custom resolution for X and Y (in px) if necessary.

**[Bitrate (constant)]:**

Choose the bitrate (in kbit/s). Recommended are about 8.000 kbit/s for SD and 20.000 or higher for HD.

**[GOP-Length]:**

The length of the Group Of Pictures is editable from 1 to 100. The higher the GOP-Length the better the compression rate gets at the expense of quality. GOP set to 1 will use I-frames only.

**[Number of B-Frames]:**

Choose a value between 0 and 7.

**[Motion Estimation Level]:**

Set a value between 0 (no motion search) and 15 (high quality). The higher the value, the better the quality, the longer the encoding process.

[Motion Estimation Range]:  
Set a value between 0 (no motion search) and 15 (high quality).

[Scene Change Detection]:  
Choose between None, Fast and Refined.

[Audio Processing]:  
Discard the Audio Part (if applicable), split it to a separate wave-file (will be created in the same folder) or choose to include it. The Audio Part is discarded by default.

### 5.2.3.28 VIEW TAB

The view tab lets you recall stored view layouts of the user interface with a single mouse click. This makes it very easy and fast to switch from one view, e.g. focusing on a large preview window and the AEON FX tabs open, to another view, e.g. displaying not the preview tab but the patch tab and having the sequence and device control tab separated.

The chapter "[Layout](#)<sup>290</sup>" describes how you can influence the GUI layout: inserting new tabs and panes, breaking panes out, removing and resizing them.

The chapter "[Views](#)<sup>257</sup>", explains how to store and recall views in the Project tab instead of doing this in the Views tab.

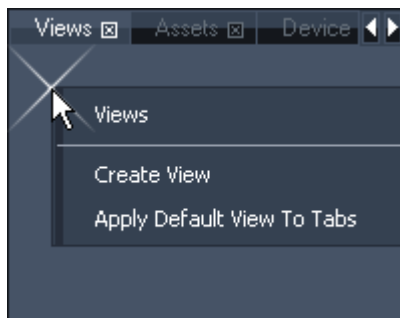

Once you have set up a view layout that you would like to store, right-click in the Views tab (in an empty region) and choose "Create View".

The new view item has now stored all tab locations and sizes of the user interface. If you're applying any changes now, you can recall the stored view at any time later on by simply clicking on it.

Choose "Apply Default To Tabs" if you want to reset the views to default layout.

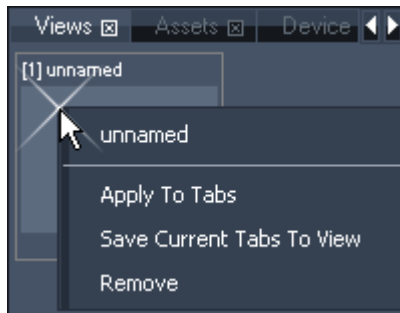

In the view tab you will see now a new entry that you can click on to activate the newly created view, or right-click on it to access its functions:

- - Apply To Tabs  
This command activates the view.
- Save Current Tabs To View  
This command lets you update and overwrite the stored view with the current view layout.
- Remove  
This command removes the view.

### 5.2.3.29 VIRTUAL SITE

Instead of using groups to get changes made on several sites, it is more comfortable to work with a Virtual Site.

All desired devices with the same device type can be combined to one virtual site. Changing a value on a layer of this virtual site will change the value on the same layer of all combined devices.

Please note:

If the sites that you want to make part of a new Virtual Site contain sequence information, all this sequence information will be deleted in the course of Virtual Site creation. This action cannot be undone!

Please select all sites that should be combined, make a right-click on one site and choose "Create Virtual Site".

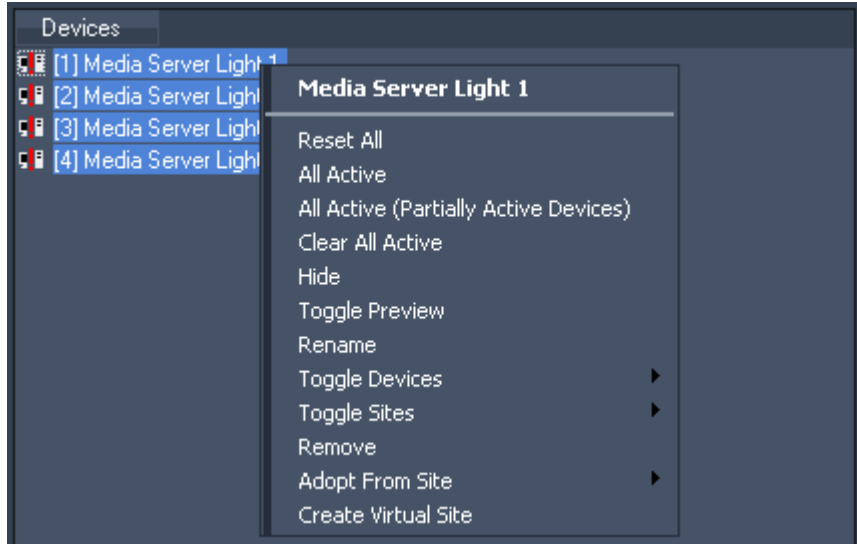

The selected sites will disappear from the device tree and you will now see the Virtual Site instead.

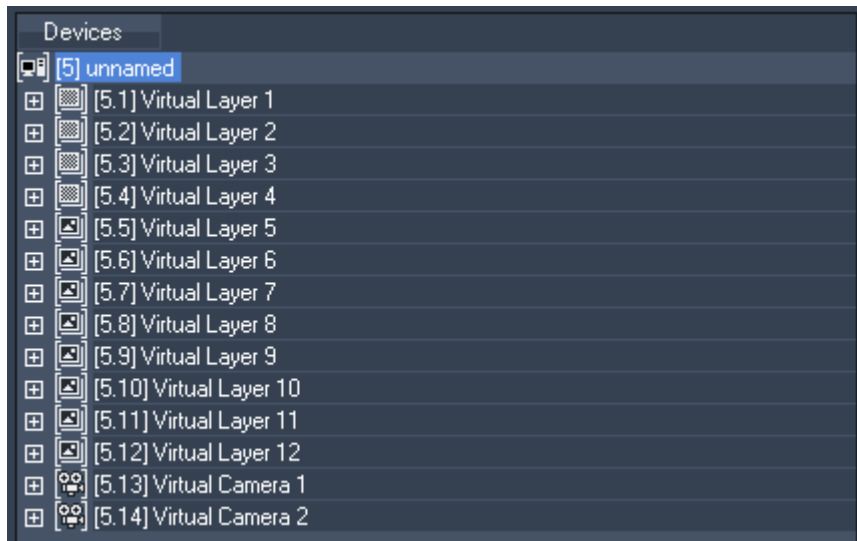

Applying a parameter value or content to Virtual Layer 1 of the Virtual Site will apply it automatically to all Layer 1 of all sites that are combined in the Virtual Site.

In order to see which sites are combined into the Virtual Site, please select the Virtual Site and open the "Virtual Site" Tab (Tabs -Virtual Site). Find here all combined Sites listed.

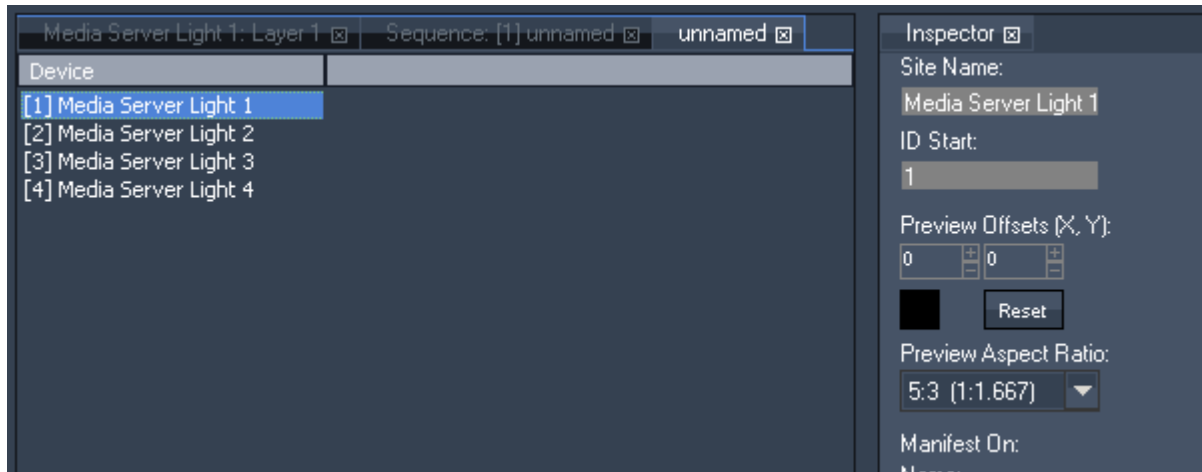

If you select one of the sites you still have access to the site inspector to edit its settings.

To set up different camera offsets for each server, select the camera device in the device tab and view the virtual site tab. You will find all camera 1 of all servers listed. Click on the parameter of the device you want to edit and enter an offset value (plus or minus) or move the mouse cursor up and down. This offset will always be added to the parameter's value that is set up for the virtual site's device. If the X Offset for the virtual cam1 is set to 32768, in this example below the X Offset of server 1 camera 1 will be 33658 (32768 + 800).

Device	Opacity	X Axis	Y Axis	Z Axis	Rot	X Off...	Y Off...	K5 L	K5 LR	K5 R	K5 RR
[1.13] Camera 1	0	0	0	0	0	800	0	0	0	0	0
[2.13] Camera 1	0	0	0	0	0	0	0	0	0	0	0
[3.13] Camera 1	0	0	0	0	0	0	0	0	0	0	0
[4.13] Camera 1	0	0	0	0	0	0	0	0	0	0	0

To reset the entered offsets, right-click on the device and choose 'Remove'.

To remove a Device from the virtual site, select the virtual site in the device tree. Then right-click on it and choose Remove.

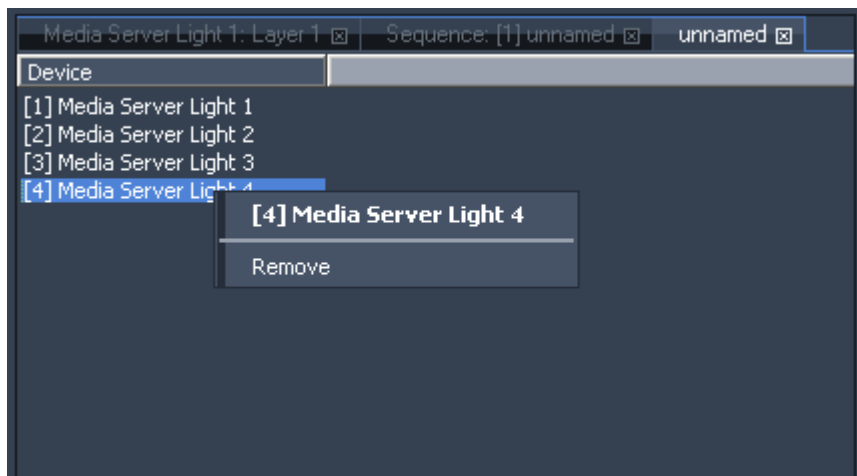

To remove the virtual site right-click on it and choose Remove. You will again get access to all single devices that were combined in the virtual site.



**Please note:**

If a single site is removed from the Virtual Site, all its sequence information will be deleted in the course of removing the Virtual Site. The same happens when deleting the whole Virtual Site. This action cannot be undone!

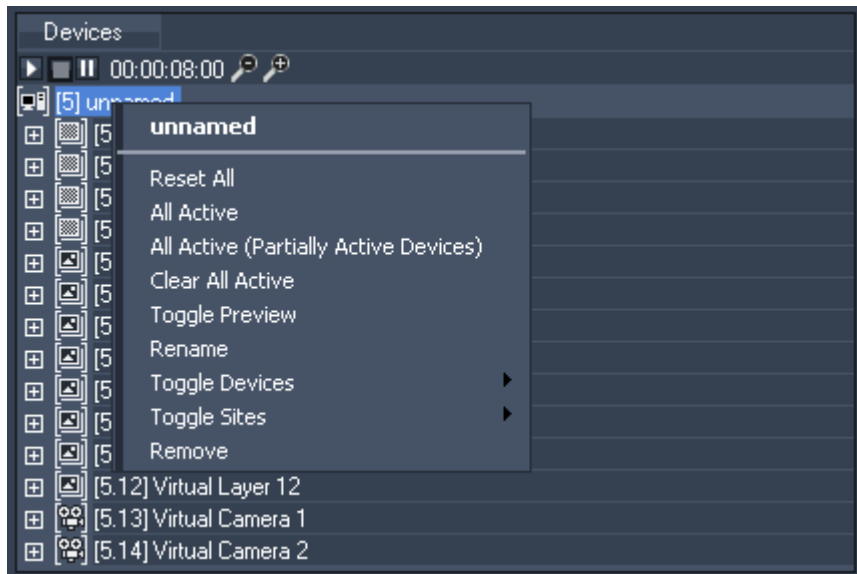

The right-click menu provides the following commands:

- Reset All  
This command will reset all parameters for all layers of this node.
- All Active  
This command will activate all parameters of all layers of this node.
- All Active (Partially Active Devices)  
This command will activate all parameters of all layers of this node that have active parameters.
- Clear All Active  
This command will de-activate all parameters of all layers of this node.
- Toggle Preview  
This command sets the node to be included in the preview tab.
- Rename  
This command will enable you to rename the node. You can also do this by pressing F2.
- Toggle Devices  
Choose which layers you want to show or hide in the device tree.
- Toggle Sites  
Choose which sites you want to show or hide in the device tree.
- Remove  
This command removes the virtual site from the device tree. You will again get access to all single devices that were combined in the virtual site

## 5.2.4 LAYOUT

The user interface layout can be customized and stored in several views to be recalled at any time during operation. A view is determined by the layout of the panes and the tabs they contain. For example the default view consists of six panes, the top left pane displays the Project tab and Sequence Control tab.

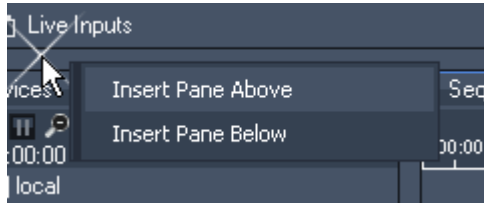

The user-interface can be freely arranged by adding or removing panes and by resizing them.

If you right-click *between* two existing panes as seen in the image to the left, or if you click between a pane and the main frame's border the context menu offers you to insert a new pane. The command "Insert Pane ..." completes either with "Above, Below, To Right or To Left" according to the position where you clicked.

A new placeholder was inserted in the main frame, as a next step you may drag an existing tab into it. Click on the title of a tab and drag it into the title of the new pane.

To adjust the pane size, left-click between two panes and drag the mouse.

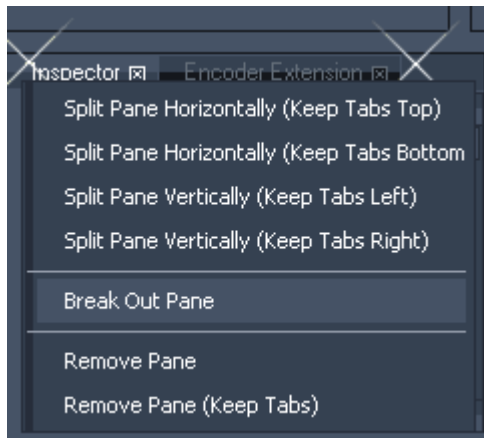

If you right-click into the title of an existing pane, you will see additional options to split the pane. If you choose to split it horizontally the existing pane will be divided into two panes, one upon the other. A vertical cut will give you two panes side by side. You may choose where you like to keep the existing tab.

The command "Break Out Pane" will release the pane from the fixed structure - it will break the pane out of the main frame. Now you can move and scale the new window independently. Note that the window will always be on-top of the GUI window.

A broken out pane offers the same options as an integrated pane: you may drag tabs into it, insert new panes or split them horizontally and vertically. You may as well remove it completely. When deciding to keep the tabs they will be moved to the next available pane.

To re-integrate a broken out pane, make a right-click into its title and choose the option "Return To Main Frame Next To Tab". Two new sub dialogs let you choose whereto position it exactly. For example you may decide to insert the broken out Inspector left to the Device Tree, it's default position.

Please note:

The Device Tree and Sequence tab can not be moved or be broken out; these two tabs are always linked to each other.

The Preview tab can only render on the screen that is a primary screen in Window's!

For example, if you have an additional monitor attached to your laptop where Pandoras Box Manager runs on and you like to have a large preview window, open the display settings

first before starting Pandoras Box and make sure that the attached screen is set up to be the primary screen. Now open the master software, break out a pane and drag the preview tab into it. Now you may move the broken out pane to the attached display and maximize the window. Please note that you will always see the Window's title bar.

Project	Ctrl-R
Assets	Ctrl-A
Device Types	
Aeon FX	
FireFly Particles	
Device Viewer	Ctrl-I
Device Controls	Ctrl-Shift-L
Virtual Site	
Active Values	Ctrl-D
Sequence	Ctrl-E
Curve Editor	
Inspector	Ctrl-M
Thumbnails	Ctrl-Shift-R
Sequence Control	
Groups	
Presets	▶
Views	
Extensions	▶
Apply Default View	
Configuration	Ctrl-K
ASIO Configuration	
Patch	Ctrl-P
Controller Setup	
Task Manager	Ctrl-Shift-M
Video Export	
Video Recording	
Media Encryption	

If you want to add additional tab items to your view layout you may find all available tab items in the main menu bar under "[Tabs](#)<sup>258</sup>". By choosing one of the items, the selected view will be created in the user-interface and can then be moved to the desired pane.

You can save several views and toggle between them with a single mouse-click. How to do this is described in the chapter "[View Tab](#)<sup>286</sup>".

## 5.2.5 KEYBOARD SHORTCUTS

F1	Launch help
F2	Rename (e.g. in tabs: Project or Device Tree)
F5	Refresh selected folder in Assets tab
CTRL + SHIFT + A	Refresh file tree in Assets tab
CTRL + left mouse click	in addition to the currently selected item, another one is selected too (e.g. in tabs: Project, Asset, Device Tree, Timeline)
SHIFT + left mouse click	in addition to the currently selected item, another one and all in between are selected too
CTRL + A	Selects all entries in a <a href="#">playlist</a> <sup>229</sup>
SHIFT + S	Spread all resources
CTRL + Pause	lock/unlock GUI (keyboard, mouse, Jog Shuttle)
CTRL + Q	Stop <a href="#">Video Export</a> <sup>281</sup>
CTRL + Z	Undo last step
CTRL + SHIFT + Z	Redo undone step

### Preview Navigation

Scroll	Zoom
Drag (middle mouse button / wheel)	Pan
ALT + Drag	Rotate
CTRL + F	Toggle fullscreen

### Timeline and Device Tree shortcuts:

SPACE	Play / Pause
ESC	Clear current device selection
CTRL + L	Lock selection
Left mouse drag in the timeline (+ ALT)	Select keys and containers in the timeline (and cues in the time bar)
CTRL + C	Copy keys, containers and cues to clipboard from source devices
CTRL + V	Paste keys, containers and cues from clipboard to same device
CTRL + SHIFT + V	Paste keys, containers and cues clipboard to selected devices
+ / - on the main keyboard;	
SHIFT + left mouse drag up/down in the time bar (above the timeline)	Zoom the timeline
SHIFT + +/-	Zoom parameter value in the <a href="#">Curve Editor tab</a> <sup>161</sup>
⏪ / ⏩	Set the nowpointer to the previous / next frame
CTRL + ⏪ / ⏩	Jump to previous / next key (including clip borders)
CTRL + ALT + ⏪ / ⏩	Jump to previous / next cue
SHIFT + ⏪ / ⏩	Move selected keys and containers to previous / next frame
CTRL + left mouse drag	Copies selected keys, containers and cues
CTRL + SHIFT + I	Toggle "Ignore Next Cue": The current loaded timeline ignores the next cue or not (toggle), the ignored cue will be colored orange.
CTRL + ALT + S	Store active values as keys to the timeline
CTRL + ALT + R	Reset all values
CTRL + ALT + C	Clear all active values but do not reset them
CTRL + ALT + A	All active (marks all values as an active value)

**File Menu shortcuts:**

CTRL + N	New project
CTRL + O	Open project
CTRL + S	Save project
CTRL + SHIFT + S	Save project as
CTRL + SHIFT + ALT + S	Save project copy
CTRL + B	Bundle project
CTRL + W	Close project
CTRL + Q	Exit application
ALT + F4	

**When working in device tree, the following shortcuts apply to current selected device:**

A	Show all parameters
H	Hide all parameters
U	Show only parameters used in sequence / Show all parameters
M	Show / hide Media parameter
O	Show / hide Mesh (Object) parameter
I	Show / hide Opacity parameter
V	Expand / collapse Playback parameters
X	Expand / collapse Audio parameters
P	Expand / collapse Position parameters
R	Expand / collapse Rotation parameters
S	Expand / collapse Scale parameters
T	Expand / collapse Rotation Pivot parameters
D	Expand / collapse Scale Pivot parameters
B	Expand / collapse Blend Mode parameter
F	Expand / collapse FX parameters
G	Expand / collapse Particle System parameters

**To open or load tabs use these shortcuts:**

CTRL + R	Open the Project tab
CTRL + T	Open the Assets tab
CTRL + I	Open the Device Viewer tab
CTRL + SHIFT + L	Open the Device Controls tab
CTRL + D	Open the Active Values tab
CTRL + E	Open the Timeline tab
CTRL + M	Open the Inspector tab
CTRL + SHIFT + R	Open the Thumbnails tab
CTRL + K	Open the Configuration tab
CTRL + P	Open the Patch tab
CTRL + SHIFT + M	Open the Taskmanager tab

### 5.3 USER INTERFACE - CLIENT

This chapter explains the user interface of a Pandoras Box Client system. The [Master's interface](#)<sup>126</sup> is covered in the previous chapter. The chapter [Master / Client Remote Setup](#)<sup>647</sup> explains the general difference between a PB Master and PB Client, how to connect them and how to include a Client device in your Master project.

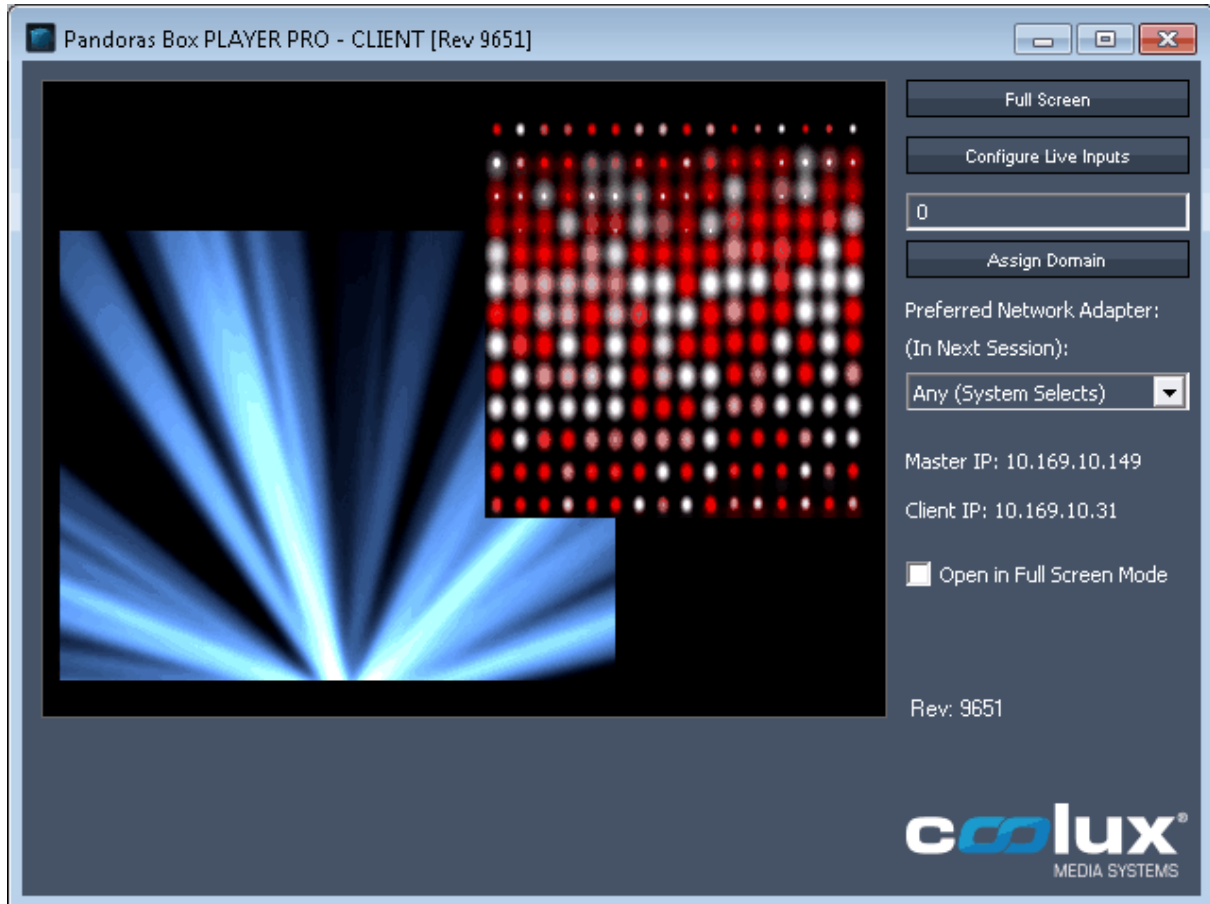

The Client User Interface allows you to set up as follows:

- Toggle Full Screen by clicking "Full Screen" or alternatively press CTRL+F
- Click "Configure Live Inputs" and a [configuration window](#)<sup>295</sup> will open (please see more details about live inputs and how to use them in Pandoras Box in the chapter ["Input Card Settings"](#)<sup>692</sup>)
- Change the domain channel and confirm it by clicking "Assign Domain"
- Choose a dedicated network adapter in the drop-down list
- Check "Open in Full Screen Mode" and the next time starting the client it will open in full screen-mode

See the following chapters for more information about the Client:

[Client Live Input Configuration](#)<sup>295</sup>  
[Client Keyboard Shortcuts](#)<sup>295</sup>

More settings regarding the render engine (e.g. Full Screen is single) can be found in the Master interface: [Configuration tab > Render Engine](#)<sup>153</sup>

### 5.3.1 CLIENT LIVE INPUT CONFIGURATION

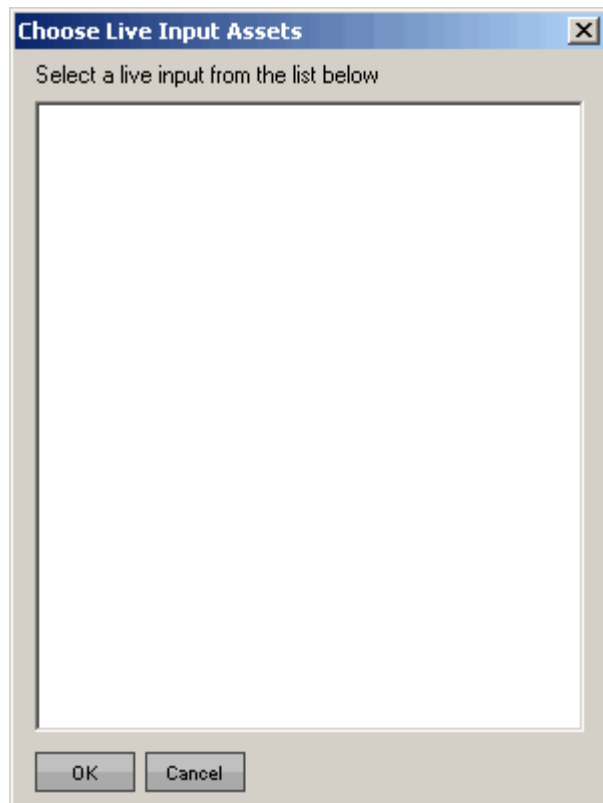

Since you may have various different live input cards or software screen grabbers available within your system, you may choose the one that you want to configure from the live input list.

Please note that Pandoras Box supports most input devices that are conform and support DirectShow.

Depending on the installed component, the according driver window will show up and lets you set up the available parameters of the input device.

[StreamiX Live Inputs are described in this chapter.](#) <sup>650</sup>

### 5.3.2 CLIENT KEYBOARD SHORTCUTS

CTRL+F

Toggle Fullscreen

## 5.4 DEVICE CONTROL



The following chapters explain all different devices and layer types that can be added to the timeline.

Please see the topics [Sequence](#)<sup>260</sup>, [Device Tree](#)<sup>168</sup> and [Device Control tab](#)<sup>164</sup> if you are rather interested in learning how to actually add devices to the device tree or how to work within the Sequence, i.e. how to change and store values, program timelines etc. The topic [User Interface](#)<sup>126</sup> describes all tabs.

One of the most important features of Pandoras Box is its ability to control a wide range of devices based on various output control protocols. Beside the Pandoras Box product range other devices such as DMX, RS232 / 422 or any TCP/IP device might be remote controlled from any timeline as well. This allows perfectly synchronized show control. The topic [External Control](#)<sup>621</sup> goes more into detail. The access to and the number of those devices is not limited whilst Pandoras Box layers depend on the Manager, Player and Server license. See the [Product Overview](#)<sup>65</sup> for detailed information.

See the following chapters:  
[V5 Video Processing Pipeline](#)<sup>297</sup> – Get a clue about the layer and rendering structure in Pandoras Box

	function	Manager	Player	Server
<a href="#">Video Layer</a> <sup>298</sup>	full motion video (and audio) playback; images	-	yes	yes
<a href="#">Graphic Layer</a> <sup>577</sup>	static images or still frames of videos	yes	yes	yes
<a href="#">Pointer</a> <sup>581</sup>	displaying the mouse pointer or touch inputs	yes	yes	yes
<a href="#">Light</a> <sup>582</sup>	illumination of other layers including shadow	-	-	yes
<a href="#">Audio Track</a> <sup>578</sup>	ASIO playback, synchronized to the master clock	yes	yes	yes
<a href="#">Camera</a> <sup>589</sup>	set up the viewpoint / look-at-point onto your 3D composition; first render path / Composition Pass	-	yes	yes
<a href="#">Output</a> <sup>597</sup>	controls the overall output of the Server or Player including keystone and softedge; second render path / Output Pass	-	yes	yes
<a href="#">DMX Devices</a> <sup>607</sup>	remote control external DMX device via DMX / Art-Net			
<a href="#">Serial Link Device</a> <sup>608</sup>	remote control Serial Link or other external RS232 / 422 or TCP/IP devices			
<a href="#">Sonic Emotion</a> <sup>609</sup>	multichannel audio plug-in for synchronized audio; requests Sonic Emotion hardware			
<a href="#">Widget Designer Device</a> <sup>609</sup>	sending commands and values to Widget Designer application			



### 5.4.1 V5 VIDEO PROCESSING PIPELINE

This chapter explains the fundamental video processing pipeline in Pandoras Box V5. It is separated in two render passes

- the (layer) composition pass, most important for the creation process
- the output pass, most important for the technical setup

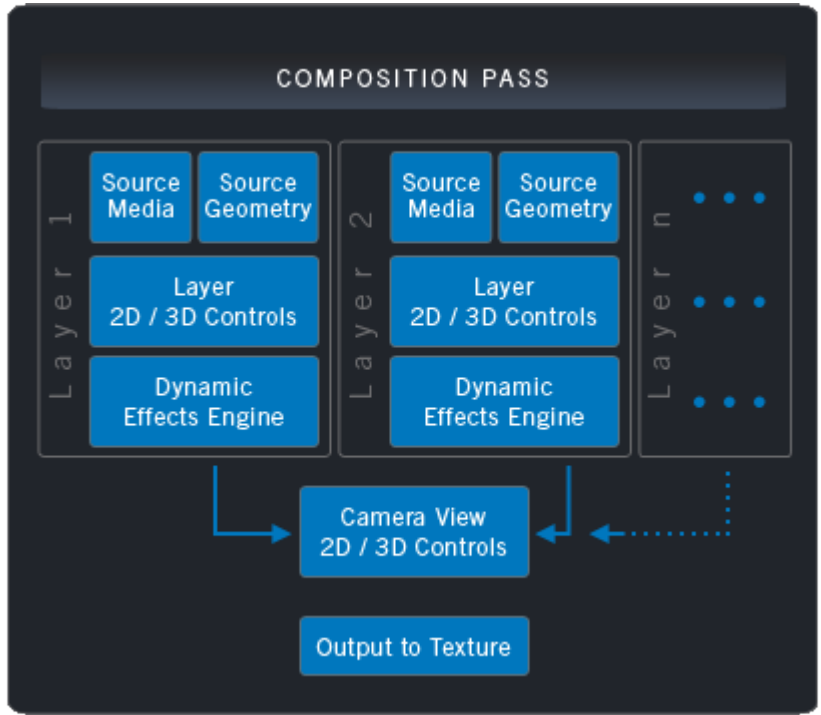

**Step 1, the Creation Process:**

Here you do your layer composition - setting the media, the video playback, position, rotation and scale parameters as well as the visual effects. The render history is determined by the Z Position respectively, if it is not set, by the layer arrangement whereas the topmost layer in the Device Tree tab is rendered first and thus overlaid by other layers. The end of step 1 is determined by adjusting the camera's perspective onto your 3D composition.

- Step 1 includes:
- [Video Layer Control](#)<sup>298</sup>
  - [Graphic Layer Control](#)<sup>577</sup>
  - [Camera Control](#)<sup>589</sup>

At the end of the composition pass, the "Output to Texture" process generates a so called render target. There is a render target for each camera. If you have a Dual Server for example, there would be two render targets. These textures are forwarded...

- to the next pass if the output's [render state](#)<sup>606</sup> is not set to bypass
- to the graphic card's output, thus your connected display if the output's [render state](#)<sup>606</sup> is set to bypass
- to be send trough the [matrix patch](#)<sup>597</sup> (note that the output's [render state](#)<sup>606</sup> may not be set to bypass)
- to be rendered for the [video export](#)<sup>281</sup>

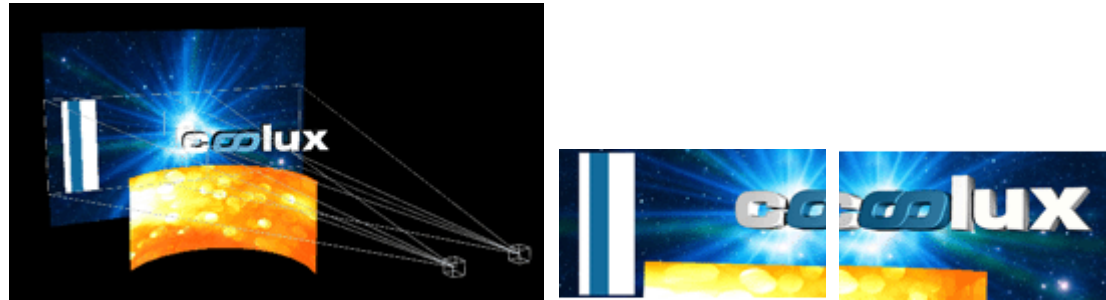

Global cam setup

Render Target 1

Render Target 2

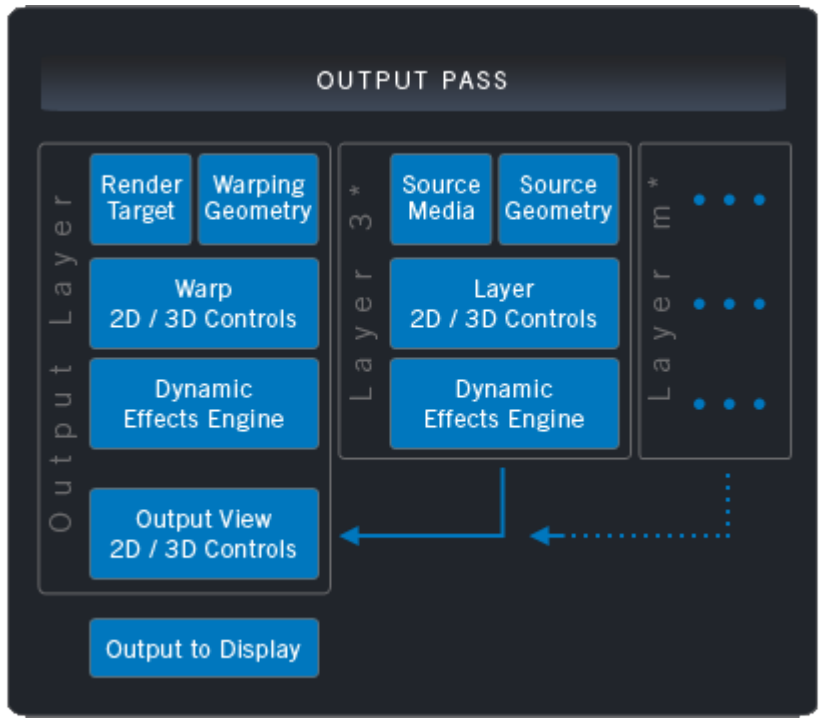

**Step 2, the Technical Setup:**

Here you match the texture to your technical setup. The source media is determined by the render target or by a video / graphic layer's media if the layer is set to not be included in the composition pass (and as a result they are not part of the render target). This can be set up in the [layer's Inspector](#)<sup>208</sup>. As this is not the default setting, the layers in the left image are marked with a star (\*).

- In the output pass you may set up:
- a warping object if the texture is projected on a bended screen,
  - softedge or keystone adjustments,
  - a color correction on the whole output (via FX)
  - blacklevel compensation

Step 2 includes above mentioned video / graphic layers controls if a layer is only rendered in this pass, and the [Output Control](#)<sup>597</sup>.

At the end of the output pass, the "Output to Display" forwards a texture to the so called backbuffer respectively to the graphic card and thus your connected display. For the above depicted example to possible outputs could be:



for output 1, a warp object has been applied and softedge settings were used



for output 2, keystone and softedge settings were used

**5.4.2 VIDEO LAYER CONTROL**

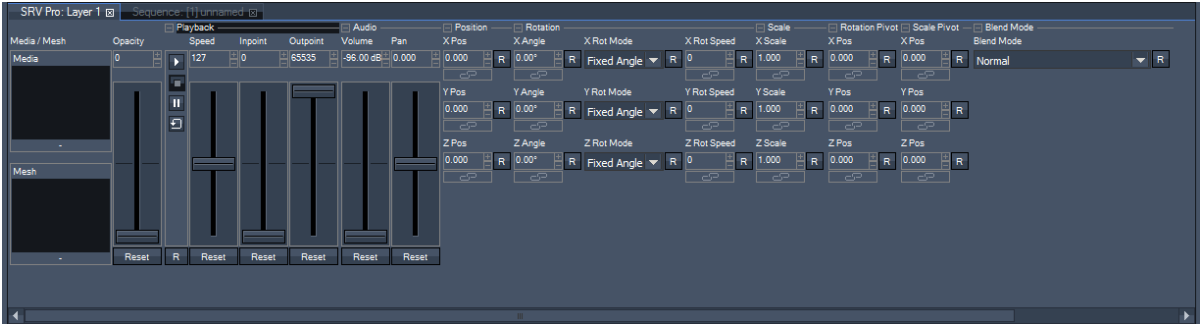

A Video Layer allows full motion video playback as well as rendering still images. The Video Layer Control includes the following sections. Information about DMX Control is included, addressing customers who wish to remote control a layer with a lighting desk via DMX or Art-Net. If you like to use the Widget Designer or another application instead, please refer to [this parameter list](#)<sup>1256</sup>.

- [Media Selection](#)<sup>299</sup>
- [Opacity](#)<sup>301</sup>
- [Playback](#)<sup>302</sup>
- [Audio](#)<sup>303</sup>
- [Position](#)<sup>304</sup>
- [Rotation](#)<sup>306</sup>
- [Scale](#)<sup>309</sup>
- [Rotation Pivot](#)<sup>311</sup>
- [Scale Pivot](#)<sup>313</sup>
- [Blend Mode](#)<sup>315</sup>
- [FX](#)<sup>319</sup>

### 5.4.2.1 MEDIA / MESH

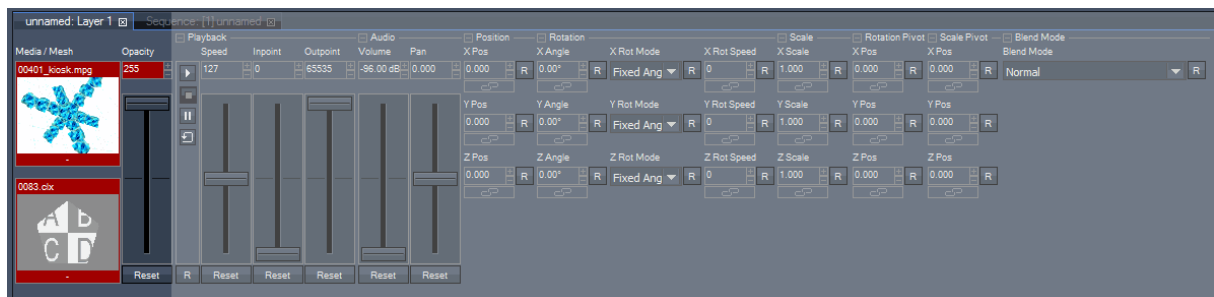

#### Media Selection

To assign a media resource to a layer, drag and drop the resource from the project tab onto the designated layer. You can also highlight the target layer by left-clicking on it and use the right-click command on the resource in the project tab “assign to active device” or just double-click on the media file. Media can also be assigned from the thumbnail browser by double clicking it for attributing it to the selected highlighted layers.

Please note: When working in a network session in Master/Client mode, please make sure that all media and objects are spread to all clients in order to be available for all servers to render.

To remove the resource of the layer, right-click on the thumbnail in the Device Control Tab and choose “Reset”. Alternatively you can open the media or mesh parameter in the layer tree and after right-clicking you can choose “Reset” there.

#### DMX Control

For DMX control depending on the ID assignment in the Pandoras Box Server user interface, each layer can access 255 folder and 255 file IDs of individual media files as well as live inputs. The media selection channels are 8bit, the default value is set to 0.

#### Media Folder

0	No folder
1..255	Folder 1..255

#### Media File

0	No file
1..255	File 1..255

## Share Layer Texture / Source Routing

A new feature of PB V5 Servers is sharing the texture of a layer with one or several other layers. This way you can playback a video file without having to load it several time. This allows a better performance than loading it several times.

Example:

To share the texture of layer 2 with layer 4, right-click in the field “Media” in the device control of layer 4 and click “Share Layer Texture”. A list with all available layers appears and “Layer 2” is chosen. Instead of a media file’s thumbnail the Layer Icon now is shown, titled by the ID of the layer whose texture is shared (here: Layer2).

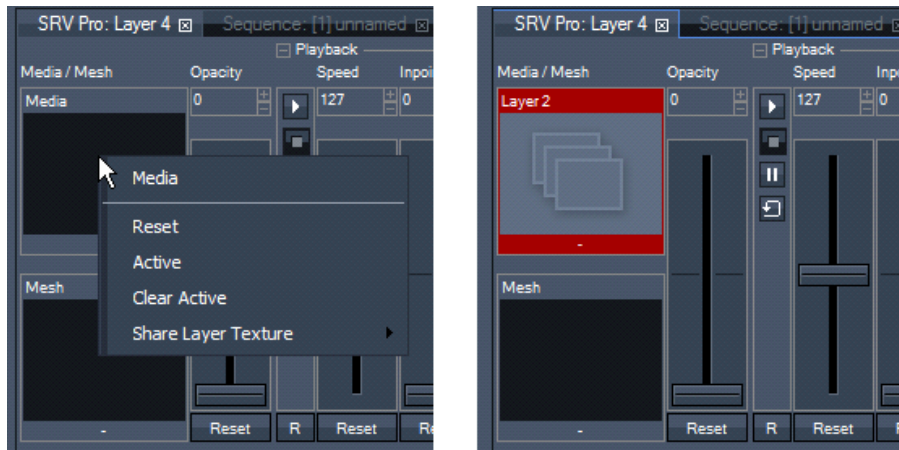

## Object Selection (Mesh)

Each Layer has a default layer object which defines the mapping of the texture (your media file). The Mesh field allows loading custom object files to change this mapping behavior. Valid object file types are .clx- and .x-files.

To assign an object to a layer, drag and drop the resource from the project tab onto the designated layer. You can also highlight the target layer by left-clicking on it and use the right-click command on the resource in the project tab “assign to active device” or just double-click on the object file.

To remove the resource from the layer, right-click in the layer tree on the object parameter and choose “reset”.

### DMX Control

For DMX control depending on the ID assignment in the Pandoras Box Server user interface, each layer can access 255 folder and 255 file IDs of individual object files.

Object file selection set to 0% (000dec.) selects “no file”.

The object selection channels are 8bit, the default value is set to 0.

### Object Folder

0	No folder
1..255	Folder 1..255

### Object File

0	No folder
1..255	Folder 1..255

### 5.4.2.2 OPACITY

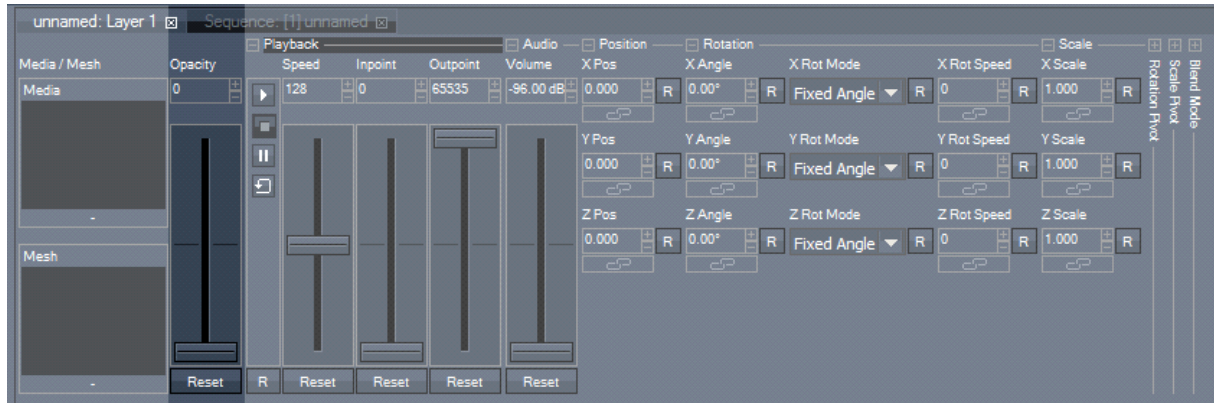

The opacity sets the transparency of an image or video content on each layer.

Opacity 0% (value 0)                      fully transparent  
 Opacity 100% (value 255)              fully visible

The opacity control allows smooth transitions for every layer. To add a [Transition FX](#)<sup>558</sup>, please see the chapter [FX](#)<sup>319</sup>.

Please note:

Compared to the handling up to PB Version 4.7, the opacity parameter does not control the audio volume anymore! No matter if the video file itself contains an audio part or a pure audio file is loaded.

The volume now is controlled by the parameter [Volume in the Audio Section](#)<sup>303</sup>.

Use the opacity control in conjunction with the [Transition FX](#)<sup>558</sup> to define the behavior of a cross-fade between two layers. Two layers blended with different kinds of TransitionFX create individual kinds of dissolves. The opacity channel always affects the entire alpha channel of the selected layer, independent from any chosen FX. A wide variety of wipes and dissolves is available in the TransitionFX section. Together with the TransitionFX, the opacity channel can also be used to superimpose two images on top of each other or to mask specific areas.

DMX Control

The opacity channel is 8bit, the default value is set to 0.

Opacity

0..255	Fully transparent..Fully visible
--------	----------------------------------

### 5.4.2.3 PLAYBACK

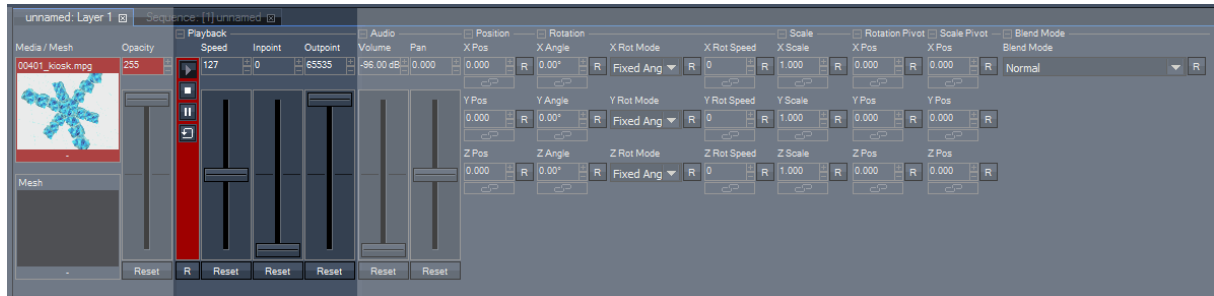

Each layer has individual playback control for video and audio files. The playback section is divided into the following parameters: Playback Transport, Speed, In- and Outpoint.

#### Playback Transport

The playback control channel allows setting the video mode to Play Once, Stop, Pause and Play Loop.

#### DMX Control

The Playback Transport channel is 8bit, the default value is set to 0.

#### Playback Transport

0	Stop
64 (1-127)	Play Once
128	Pause
192 (129-255)	Play Loop

#### Playback Speed

The speed of the video playback may be varied by changing the Speed Parameter value. The default value (1:1 Speed) is 128 (=100% in percentage view, see [configuration tab](#)<sup>139</sup>).

Slowing down the speed of a video file will reduce the framerate. In order to keep a smooth playback you may want to use [FluidFrame™](#)<sup>190</sup> for this video file.

Please note: The speed and playback behavior varies, depending on the used codec.

Some video codecs may not support different playback speeds and some codecs may not be suitable for seamless looping.

Optimal playback can be achieved if you use mpg2 files or Microsoft DV AVI files.

Please see the [Encoding](#)<sup>103</sup> section and the [format](#)<sup>102</sup> description for further information as well.

#### DMX Control

The Speed channel is 8bit, the default value is set to 128.

#### Playback Speed

0..127	slower
128	1:1 Speed
129..255	faster

## Inpoint / Outpoint

Set the in- and outpoint to define the specific start & end marks of a clip, the play once and play loop video mode will work in the resized area.

The In- & Outpoint selection works on a percentage base of the overall frame length. Use "Pause" and look up with the Inpoint the frames from where you want to start the file playback.

When programming containers in the timeline you can alternatively enter the exact frame number you like to start (or end with) by using the "In" (or "Out") value in the [Clip Inspector](#)<sup>202</sup>. It is also possible to enter exact timecode in frames, seconds etc.

### DMX Control

The In- and Outpoint channels are 16bit.

Inpoint, the default value is set to 0.

0	File beginning
65535	End of file

Outpoint, the default value is set to 65535.

0	File beginning
65535	End of file

## 5.4.2.4 AUDIO

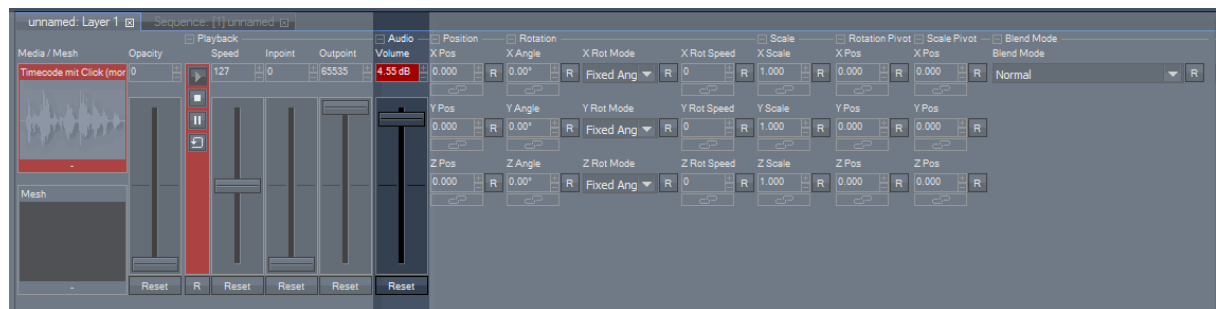

With the Volume parameter in the Audio Section you will control the Volume of both: Video Files including an audio part and plain audio files such as .wav- or .mp3-files.

Note that playing back sound with a video layer eliminates the possibility to synchronize the video playback. If synchronized playback is demanded, please use [ASIO tracks](#)<sup>578</sup> instead.

### DMX Control

The volume channel ranges from -96 dB to +6 dB, this corresponds to the DMX values 0..65535.

The Audio Channel is 16bit, the default value is set to - 96 dB.

Please note, that for Widget Designer or other controlling applications, the range of values is 0 - 2, more information can be found in the [parameter list](#)<sup>1256</sup>.

### 5.4.2.5 POSITION

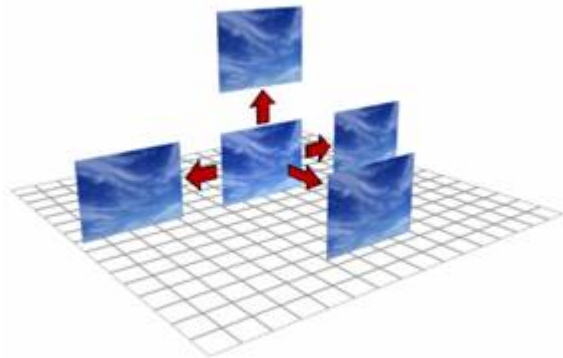
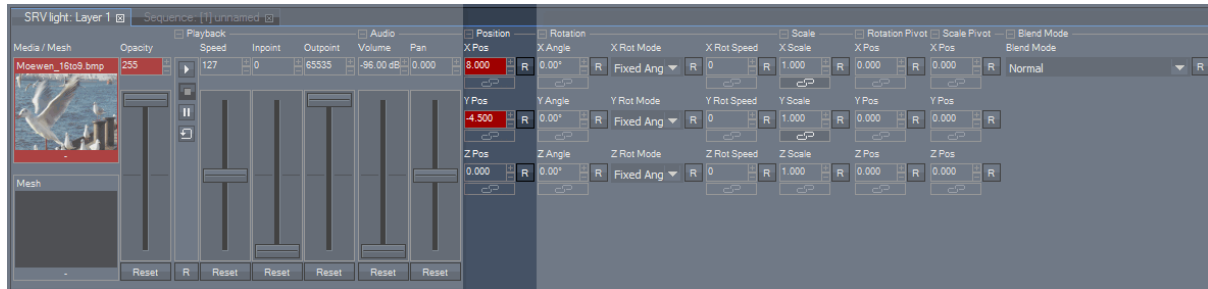

For Server, each layer can be positioned in XYZ individually. Players do not support the Z axis.

Each position parameter covers the value range from -999.999 to +999.999 units for pixel accurate positioning of layers (the DMX Control uses a 16 bit channel covering the value range -256 to +256 units, see below).

The Pandora's Box output is always 16 units wide. The height is calculated by the aspect ratio.  
 A 4:3 display is 16 units wide and 12 units high.  
 A 16:9 display is 16 units wide and 9 units high.

Example:

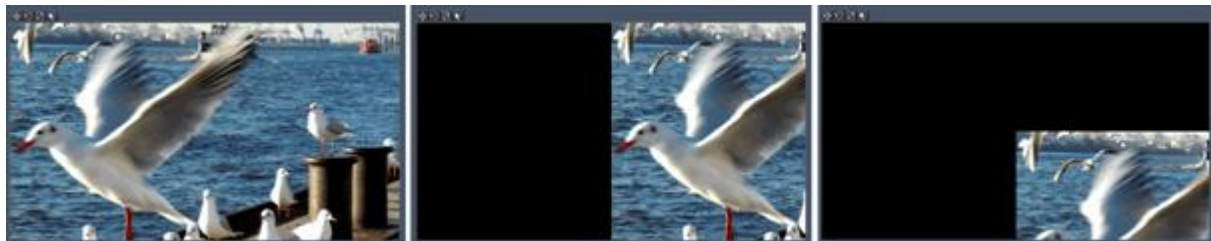

The image on the left shows a 16:9 image/layer with X-/Y-/Z-Position = 0.  
 Image in the middle: the X Pos is set to +8.000: the layer moves half of its width to the right.  
 Image on the right: the Y Pos is set to -4.500: the layer moves half of its height down.

By default the position pivot is located in the layer's center. Only the scale and rotation pivot can be relocated.



DMX Control

All position channels are 16bit and the default value is 32768.

Resolution: 1 DMX Step = 0.008 units

X Position (16 bit):

0	max. Image offset left (-256 units or 16 screen width to the left)
32768	Center
65535	max. Image offset right (+256 units or 16 screen width to the right)

Y Position (16 bit):

0	max. Image offset bottom (-256 units)
32768	Center
65535	max. Image offset top (+256 units)

Z Position (16 bit):

0	max. Image offset far (-256 units)
32768	Center
65535	max. Image offset near (+256 units)



Images above: Depending on the XYZ position of a layer, the Z position affects the [rendering order](#)<sup>170</sup>.

Please note: If the [camera](#)<sup>590</sup> is set to “perspective projection mode”, the Z axis will visually affect the size of the selected layer. This will not happen in any “orthogonal” mode.

### 5.4.2.6 ROTATION

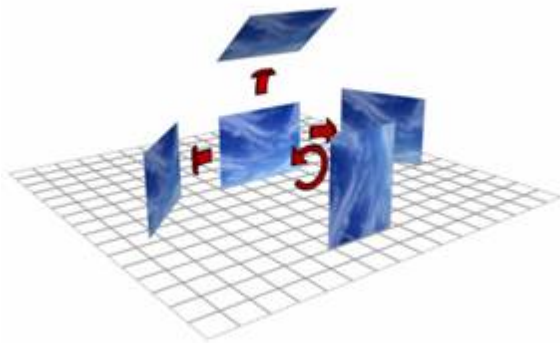

For Server, each layer can be rotated in XYZ individually. Players only support the rotation about the Z axis.

For each axis you have parameters to set the angle, the rotation mode (Fixed Angle or Rotation Speed) and the rotation speed.

By default the rotation pivot is located in the layer's X/Y/Z center. This can be changed by modifying the rotation pivot's position in the ["Rotation Pivot"-Section 311](#).

#### Rot Mode

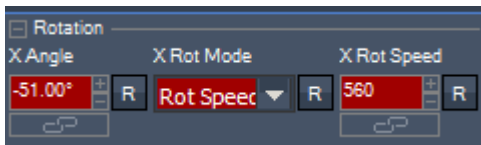

Depending on the rotation mode a fixed angle (in °) or a rotation speed (in rotations per hour) may be applied to the X-/Y- and Z axis. By default the rotation mode is set to "fixed angle".

If the Rot Mode is set to "Rot Speed", the layer will rotate continuously. Any changes to the fixed Angle value won't affect the rotation any more.

#### DMX Control

All Rotation Mode channels are 8bit and the default value is 0.

##### X Rot Mode

0	Fixed Angle
1	Rotation Speed

##### Y Rot Mode

0	Fixed Angle
1	Rotation Speed

##### Z Rot Mode

0	Fixed Angle
1	Rotation Speed

### X / Y / Z Angle

Use the X/Y/Z Angle to set a fixed angle to the layer. Please note that the Rotation Mode needs to be set to "Fixed Angle" to apply this angle!

Each angle parameter (X/Y/Z angle) covers the value range -999.999° to +999.999°, this corresponds to almost 3x 360° turns into the positive and negative direction.

The DMX Control uses a 16 bit channel for each angle parameter, covering the value range -1080° to +1080°, see below.



#### DMX Control

All angle channels are 16bit and the default value is 32768.

Resolution: 1 DMX Step = 0.033°

#### X Angle

0	-1080° or 3 rotations forward
32768	0°
65535	+1080° or 3 rotations backward

#### Y Angle

0	-1080° or 3 rotations to the right
32768	0°
65535	+1080° or 3 rotations to the left

#### Z Angle

0	-1080° or 3 rotations clockwise
32768	0°
65535	+1080° or 3 rotations anti-clockwise

### X / Y / Z Rot Speed

Use the X/Y/Z Rot Speed to set a continuous rotation to the layer. Please note that the Rotation Mode needs to be set to "Rotation Speed" to apply this continuous rotation!

Each rotation speed parameter (X/Y/Z rotation speed) is 16 bit and covers the value range -32768 to +32768.

1 Unit / DMX Step corresponds to 1 rotation per hour.

Example:

To turn the layer 2 times per second the Rot Speed should be set to  $60 \text{ (minutes)} \times 60 \text{ (seconds)} \times 2 = 7200$ .

- 1 rotation per hour: value 1
- 1 rotation per minute: value 60
- 1 rotation per second: value 3600

#### DMX Control

All Rotation Speed channel are 16bit and the default value is 32768.

Resolution: 1 DMX Step = 1 rotation per hour.

#### X Rot Speed

0	min. Rotation Speed
32768	Stop
65535	max. Rotation Speed

#### Y Rot Speed

0	min. Rotation Speed
32768	Stop
65535	max. Rotation Speed

#### Z Rot Speed

0	min. Rotation Speed
32768	Stop
65535	max. Rotation Speed

### 5.4.2.7 SCALE

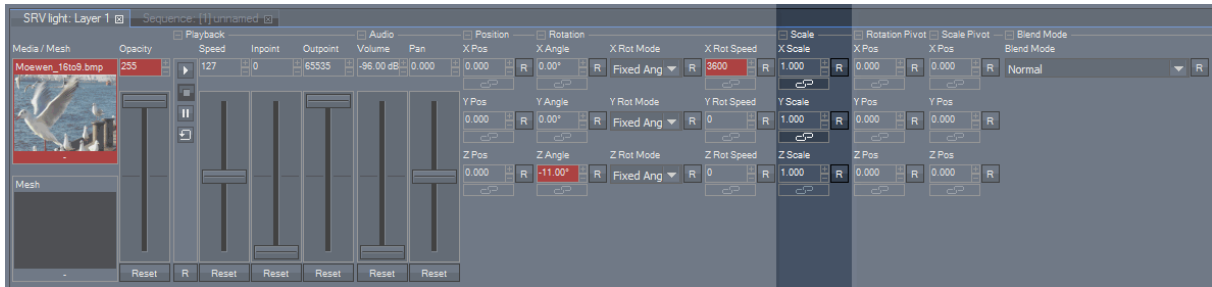

Image scaling allows setting either individual aspect ratios or object sizes. Whilst the Server supports scaling along the XYZ axis, Players do support X and Y only.

When using the scaling on a layer the assigned video or still image is resized automatically to the scale of the object. Scaling can also be used to zoom into a layer while the pixels are interpolated to give a smooth result.

Each scale parameter covers the value range from -999.999 to +999.999 units (the DMX Control uses a 16 bit channel covering the value range 0 to 65535 units, see below).

By default the scale pivot is located in the layer's X/Y/Z center. This can be changed by modifying the scale pivot's position in the ["Scale Pivot"-Section](#)<sup>313</sup>.

Scaling values:

2:	double size
1 (default):	original size
0.5:	half size
0:	minimum size (layer is not visible)
-0.5:	half size, layer is flipped
-1:	original size, layer is flipped
-2:	double size, layer is flipped

Example:

This is the original image.



The X Scale factor is varied in the image sequences below

Image Sequence1: Left: X Scale=2; Center: X Scale=1; Right: X Scale=0.5



Image Sequence2: Left: X Scale=-0.5; Center: X Scale=-1; Right: X Scale=-2

DMX Control

All scale channels are 16bit and the default value is 1000.

Resolution: 1 DMX Step = 0.001 units.

X Scale

0	min. Scale (layer is not visible)
1000	1:1 Scale
65535	max. Scale (scaling factor: 65.535)

Y Scale

0	min. Scale (layer is not visible)
1000	1:1 Scale
65535	max. Scale (scaling factor: 65.535)

Z Scale

0	min. Scale
1000	1:1 Scale
65535	max. Scale (scaling factor: 65.535)

Please note: due to the reduced DMX control value range the image can not be flipped!

### 5.4.2.8 ROTATION PIVOT

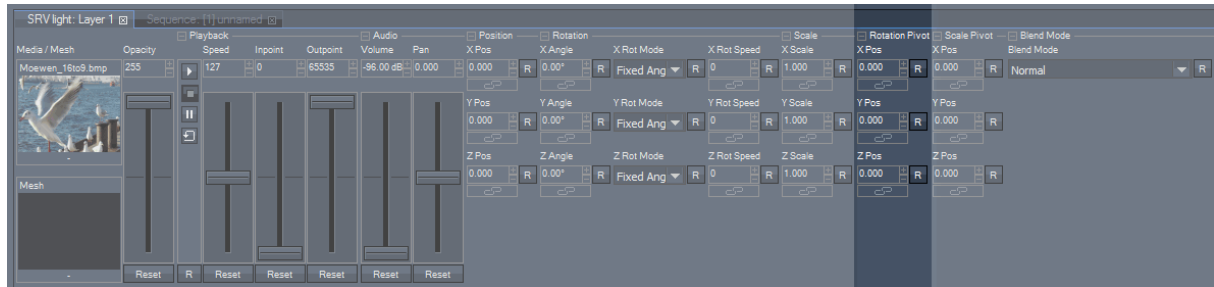

The rotation pivot section allows moving the rotation pivot to positions others than the layer's center point. Any X, Y and Z Rotation applied to this layer then will use the new position as pivot. Please remember that Players do not support the Z axis.

Each position parameter covers the value range from -999.999 to +999.999 units (the DMX Control uses a 16 bit channel covering the value range -256 to +256 units, see below).

The Pandora's Box output is always 16 units wide. The height is calculated by the aspect ratio.  
 A 4:3 display is 16 units wide and 12 units high.  
 A 16:9 display is 16 units wide and 9 units high.

#### How the Rotation Pivot effects the rotation

Applying a Z Rotation with the default position of the rotation pivot (X/Y/Z Pos=0) turns the layer around its center point.



The image sequence shows Z rotation angles from 0° to -180°. The Rotation Pivot's position is set to default (X/Y/Z Pos = 0; Center Point).

Now the position of the rotation pivot is changed to X Pos=8 (right screen border) and Y Pos=4.5 (top screen border).

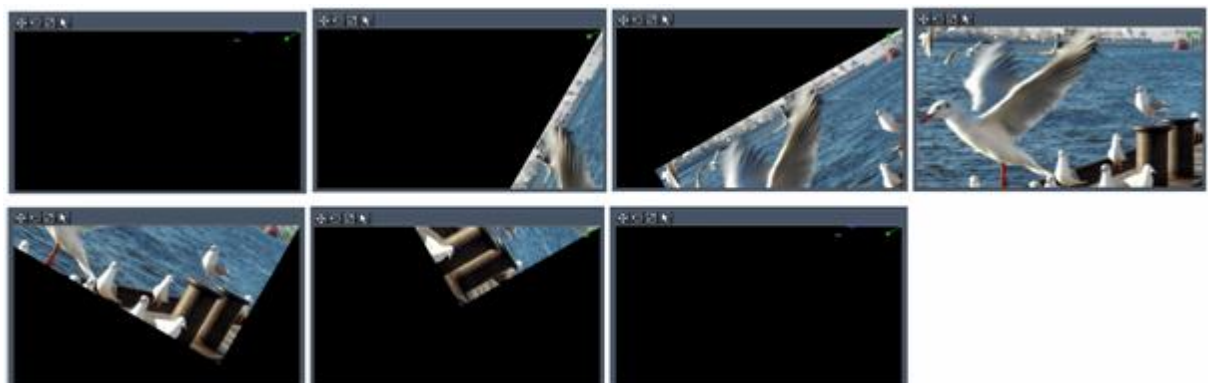

The image sequence shows Z rotation angles from +90° to -90°, the rotation pivot is located in the corner top right.

#### Viewing the Rotation Pivot

In order to see the position of the rotation pivot in the [preview window](#)<sup>239</sup>, please do this:

1. Check the option "Show Handles" below the preview window.

2. Now click the rotation icon on the top left.
3. The rotation pivot gets visible.

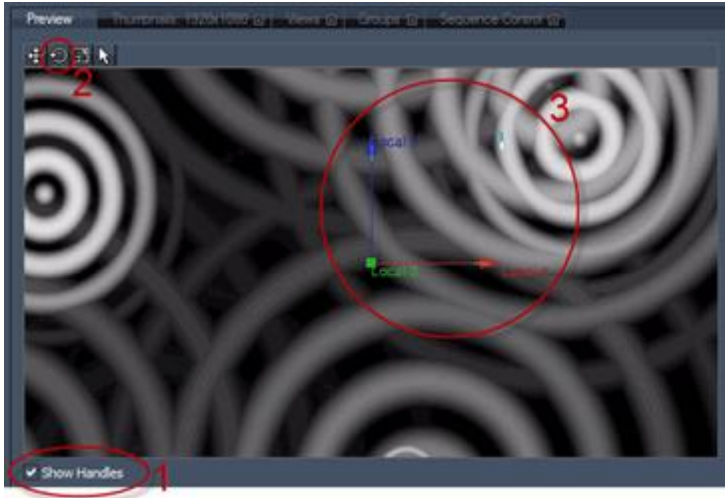

When changing the position of the rotation pivot with the rotation pivot X/Y/Z Pos parameters, the pivot will move to its new position. If the rotation pivot is located outside the output area, you may change over to Global Cam View to still see its position:

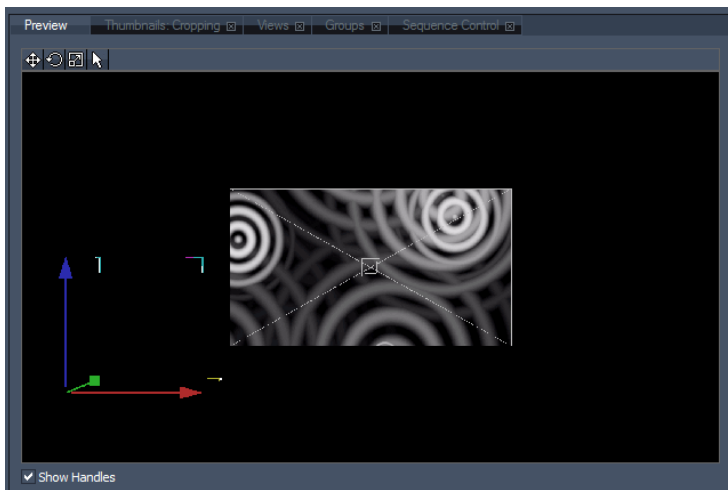

Image above: the position of the rotation pivot is changed to X Pos=-17.2, Y Pos=-7.1, it is outside the outputs visible area.

**DMX Control**

All rotation pivot channels are 16bit and the default value is 32768.

Resolution: 1 DMX Step = 0.008 units

**Rotation Pivot's X Position**

0	max. rotation pivot offset left (-256 units)
32768	Center
65535	max. rotation pivot offset right (+256 units)

**Rotation Pivot's Y Position**

0	max. rotation pivot offset bottom (-256 units)
32768	Center
65535	max. rotation pivot offset top (+256 units)

**Rotation Pivot's Z Position**



0	max. rotation pivot offset far (-256 units)
32768	Center
65535	max. rotation pivot offset near (+256 units)

**5.4.2.9 SCALE PIVOT**

The scale pivot section allows moving the scale pivot to positions others than the layer's center point. Any X, Y and Z scale applied to this layer then will use the new position as pivot. Please remember that Players do not support the Z axis.

Each position parameter covers the value range from -999.999 to +999.999 units (the DMX Control uses a 16 bit channel covering the value range -256 to +256 units, see below).

The Pandoras Box output is always 16 units wide. The height is calculated by the aspect ratio.  
 A 4:3 display is 16 units wide and 12 units high.  
 A 16:9 display is 16 units wide and 9 units high.

**How the Scale Pivot effects the scale**

Applying an X&Y Scale with the default position of the scale pivot (X/Y/Z Pos=0) scales the layer evenly around its center point.



The image sequence shows a Layer, scaled in X and Y from factor 1 to factor 0.25. The Scale Pivot's position is set to default (X/Y/Z Pos = 0; Center Point).

Now the position of the scale pivot is changed to X Pos=-8 (left screen border) and Y Pos=4.5 (top screen border).



The image sequence shows a layer, scaled in X and Y from factor 1 to factor 0.25 The Scale Pivot's position is located in the corner top left.

**Viewing the Scale Pivot**

In order to see the position of the scale pivot in the [preview window](#)<sup>239</sup>, please do this:

1. Check the option "Show Handles" below the preview window.
2. Now click the scale icon on the top left.
3. The scale pivot gets visible.

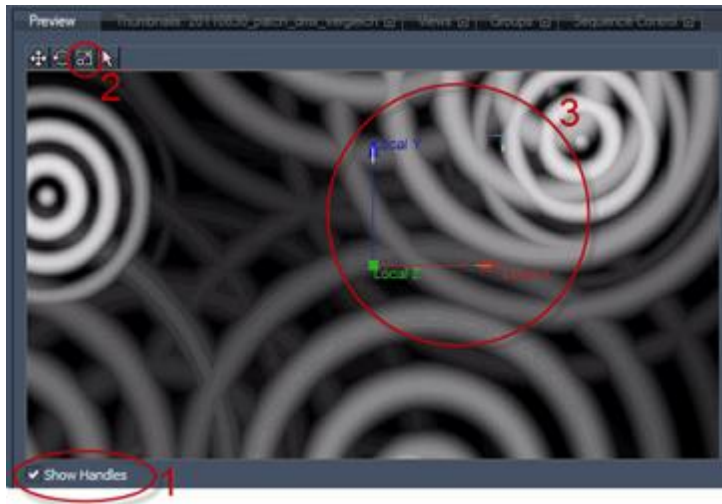

When changing the position of the scale pivot with the scale pivot X/Y/Z Pos parameters, the pivot will move to its new position. If the scale pivot is located outside the output area, you may change over to Global Cam View to still see its position:

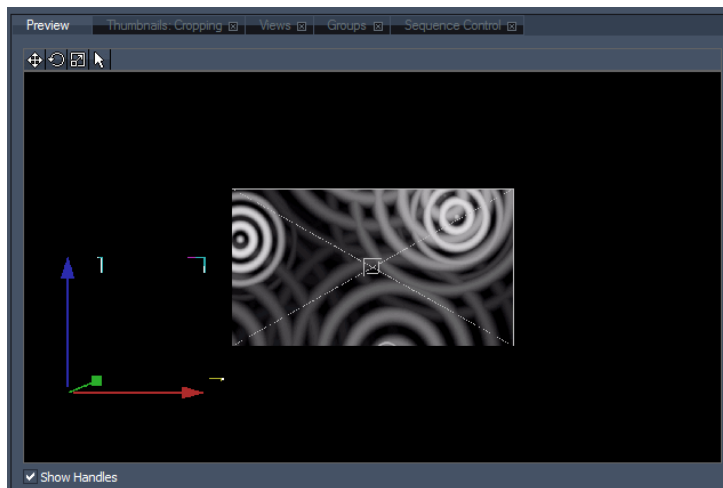

Image above: the position of the scale pivot is changed to X Pos=-17.2, Y Pos=-7.1, it is outside the visible output area.

**DMX Control**

All scale pivot channels are 16bit and the default value is 32768.

Resolution: 1 DMX Step = 0.008 units

**Scale Pivot's X Position**

0	max. scale pivot offset left (-256 units)
32768	Center
65535	max. scale pivot offset right (+256 units)

**Scale Pivot's Y Position**

0	max. scale pivot offset bottom (-256 units)
32768	Center
65535	max. scale pivot offset top (+256 units)

Scale Pivot's Z Position

0	max. scale pivot offset far (-256 units)
32768	Center
65535	max. scale pivot offset near (+256 units)

**5.4.2.10 BLEND MODE**

Blend modes in digital image editing are used to determine how two layers are blended into each other. On Pandoras Box Servers and Players, the default blend mode (called "normal") is simply to hide the lower layer with whatever is present in the top layer. However, as each pixel has a numerical representation, a large number of ways to blend two layers is possible.

**Normal**

The lower layer will be hidid by the content on the top layer.



**Mask / Fill**

With a combination of the Blend Modes Mask and Fill a key and fill effect can be set up: Layer A is supposed to be mixed with Layer B with a Mask in between that benefits from all sizing, positioning and rotation features in 2D and 3D. The mask can be anything, a still image or a video file.

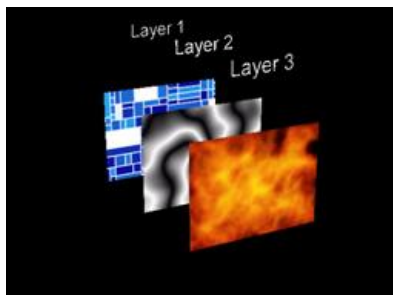

This KEY+FILL effect is based on the layer stack from back to front, as the back layer is being rendered first and every other layer is rendered on top of the previous one. By making use of this technique every layer can make use of the alpha blend modes to define how its pixel RGB+Alpha (RGB32) values are mixed with the previous rendered images.



Layer 1 = Background Content

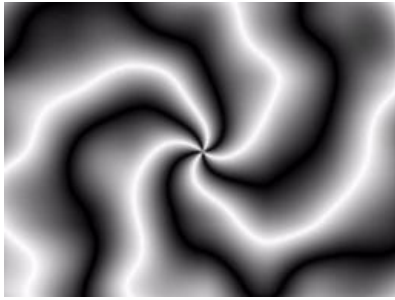

Layer 2 = Black&White Mask.

Set the Blend Mode to "Mask". Add a White Key and key out all white parts of the image. The "mix" parameter of the White Key needs to be set to 255

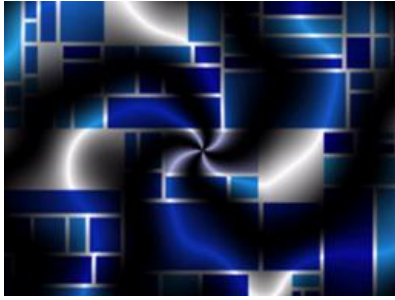

This is the result of Layer 1 and Layer 2.



Layer 3 = Content to be filled onto the mask. Set Blend Mode to "Fill".

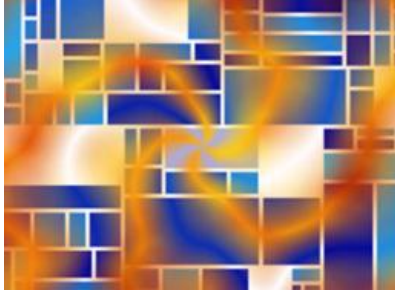

This is the result: the Key & Fill effect.

Please note:  
When alpha blend modes are used the opacity ranges from 1-255, a zero value switches off the layer to be rendered, and therefore switches the mode back to default opacity mixing.

If the Key & Fill Layers (Layer 2 and 3 in the example above) should be faded in / faded out, please use the Mix-Parameter of the White Key of the Mask Layer to do so, instead of using the Opacity of both Layer 2 and 3.

### Screen

With Screen blend mode the values of the pixels in the two layers are negated, multiplied, and then negated again. The result is a brighter picture.



### Add

This blend mode simply adds pixel values of one layer with the other. In case of values above 255 (in the case of RGB), white is displayed.



### Custom

Here you may use a customized blend mode. By default the blend mode normal is set. To create your own blend mode, you have to modify the dedicated entries in the tweak config file. This can be found here:  
Pandoras Box root folder\data\config\tweak\_config.txt

When opening this .txt-file scroll down to this section:

```

;-----;

;description:
;define custom layer blending with operation and mode for color and alpha.

;possible values for blend operations are defined in D3DBLENDOP

;find more information here: http://msdn.microsoft.com/en-us/library/bb172509\(VS.85\).aspx

;possible values for blend modes are defined in D3DBLEND

;find more information here: http://msdn.microsoft.com/en-us/library/bb172508\(v=vs.85\).aspx

;default:
;blendOpColor=1
;srcBlendColor=5
;destBlendColor=6
;blendOpAlpha=1
;srcBlendAlpha=5
;destBlendAlpha=7

[LayerBlending]
blendOpColor=1
srcBlendColor=5
destBlendColor=6
blendOpAlpha=1
srcBlendAlpha=5
destBlendAlpha=7

```

```

;-----;

```

Modify the entries under the section [LayerBlending] to create your own blend mode, like described below in the tweak\_config.

Please note:

Close the PB application before editing the tweak config file!

These edited mode settings have to be done on each PB device that should be able to use this mode!

### 5.4.2.11 FX

The new dynamic shader effects engine allows creating and combining an almost unlimited number of effects. All effects and animations are automatically synchronized across the system network.

Please note:

Depending on your PB device the amount of permitted effects can be limited. Please see the [Product Overview](#)<sup>[65]</sup> for further details.

This chapter is divided into the following themes:

- [Adding FX](#)<sup>[319]</sup>
- [FX Order](#)<sup>[321]</sup>
- [FX Parameter](#)<sup>[323]</sup>
- [Copy / Paste FX](#)<sup>[324]</sup>
- [Removing FX](#)<sup>[328]</sup>
- [FX List](#)<sup>[328]</sup>

There are a few things important to know when working with FX:

- Generally the layers come without any effect applied (except if the site/project is started in [Lighting Console Configuration](#)<sup>[222]</sup>). If necessary you may add one or several FX from the FX tab to your layer, see chapter [Adding FX](#)<sup>[319]</sup>.
- The FX build upon each other according to their order in the FX chain. Having the FX order FX1>FX2 may achieve a result different from FX2>FX1. So the result is influenced by the order of the FX! See chapter [FX Order](#)<sup>[321]</sup>.

#### 5.4.2.11.1 ADDING FX

Generally the layers come without any FX applied, except if the site/project is started in Lighting Console Configuration.

If you have a look into the Device Tree of a plain video layer, there are no FX inside the FX folder, see image below.



To add an effect to a video layer, graphic layer or output device, change to the [FX Tab](#)<sup>[136]</sup> and choose the effect from one of the theme folders. Using the Filter View drop-down list will show all FX that are available for your PB device.

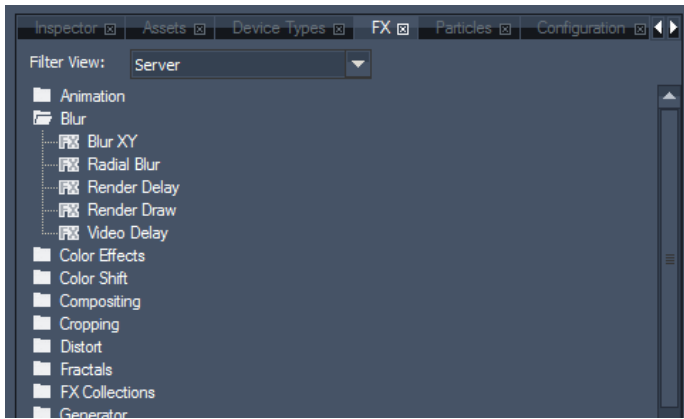

Image above: the Filter is set to display all FX available for PB Servers.

Choose the effect and drag and drop it onto the layer, or select the layer (it will be highlighted in blue) and execute a double-click on the desired effect.

After adding the FX it will be shown  
 . in the layers FX folder in the Device Tree  
 - next to the standard parameters in the Device Control Tab.

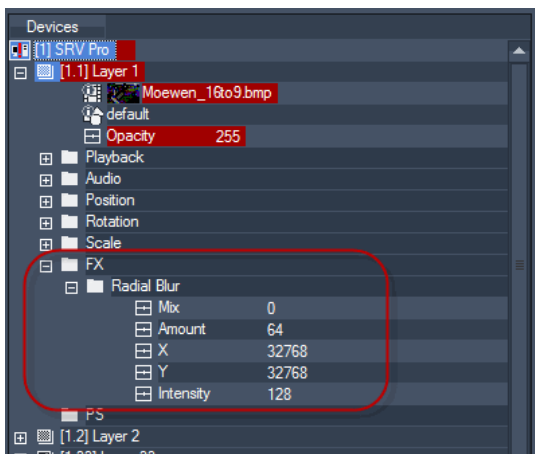

Image above: the newly added FX “Radial Blur” is shown in the Device Tree in the folder “FX”. After unfolding it (by double-clicking the “Radial Blur”-folder or by clicking the “+” icon in front of it) all parameters belonging to this effect will be listed as well.

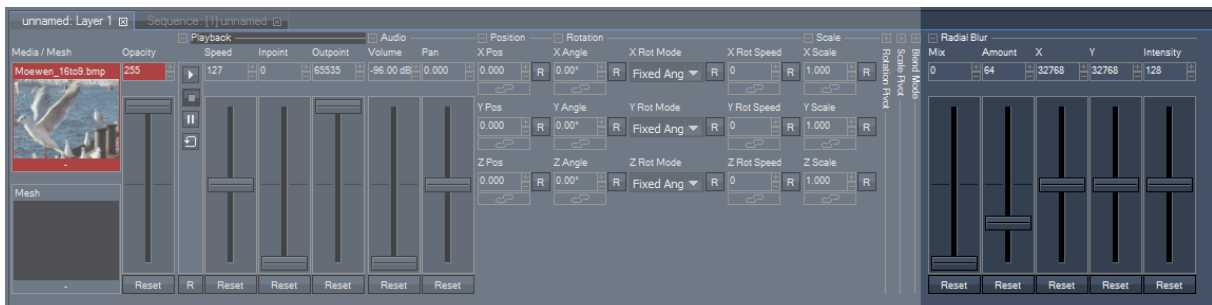

Image above: the FX “Radial Blur” is shown in the Device Control Tab next to the collapsed “Blend Mode”. The new section is always titled with the name of the FX (“Radial Blur”). All parameters of the FX are listed in this section.



The default values of every effect are set in a way that the effect won't affect the layer texture automatically after it is added to the layer. You need to modify the Mix parameter in order to apply the effect.

If you need more effects on your device, just repeat this procedure as often as needed. Every effect will be attached to the FX list in the Device Tree / next to the last effect section in the Device Control tab.

Please note:

The order of the FX is very important, as they build upon each other! Having FX1 applied in front of FX2 in the FX chain may give a different result as having FX2 in front of FX1, see chapter [FX Order](#)<sup>321</sup>.

### 5.4.2.11.2 FX ORDER

The FX build upon each other according to their order of appearance. When several FX are applied to a layer, the order of these FX is important!

Having the order FX1>FX2 may achieve a result different from the order FX2>FX1. The following example shows how the effect order influences the result.

Example:



This is the original image file on the layer.

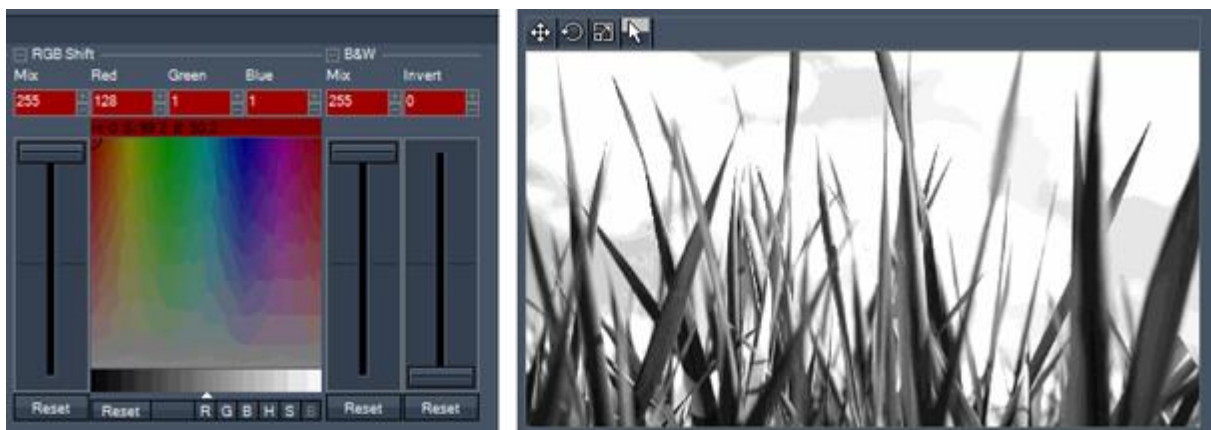

Left image: Two FX are added to the layer. First FX: RGB Shift, second FX: B&W.

Right image: the result looks like this. After the RGB Shift FX was applied, the whole layer is turned into Black&White mode.

Turning the order of the FX, the result can look totally different!

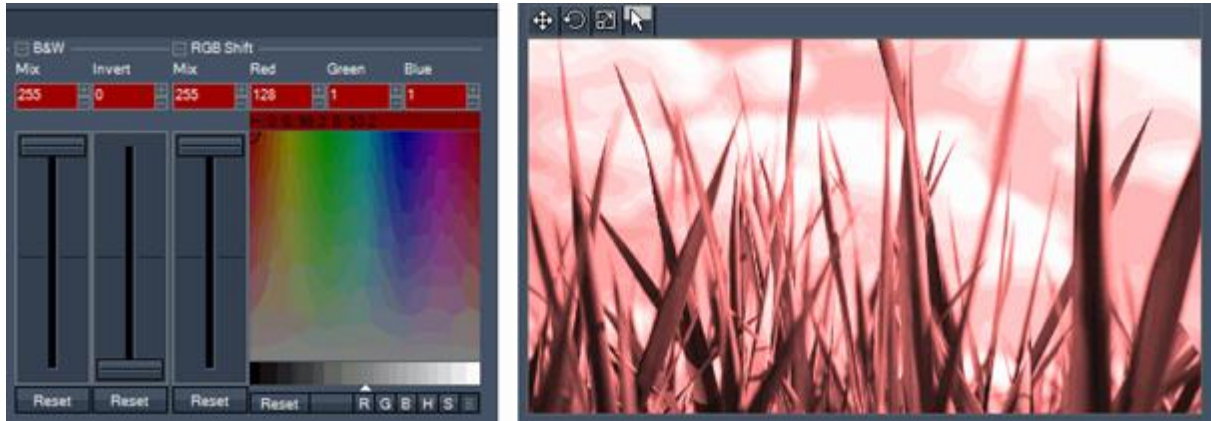

Left image: Now the B&W FX is applied before the RGB Shift FX.

Right image: after the image was turned into Black&White mode, it is now shifted to the colour red.  
 If the order of the FX should be modified, go to the Device Tree tab. Drag the effect folder that should be moved and drop it further up or down.

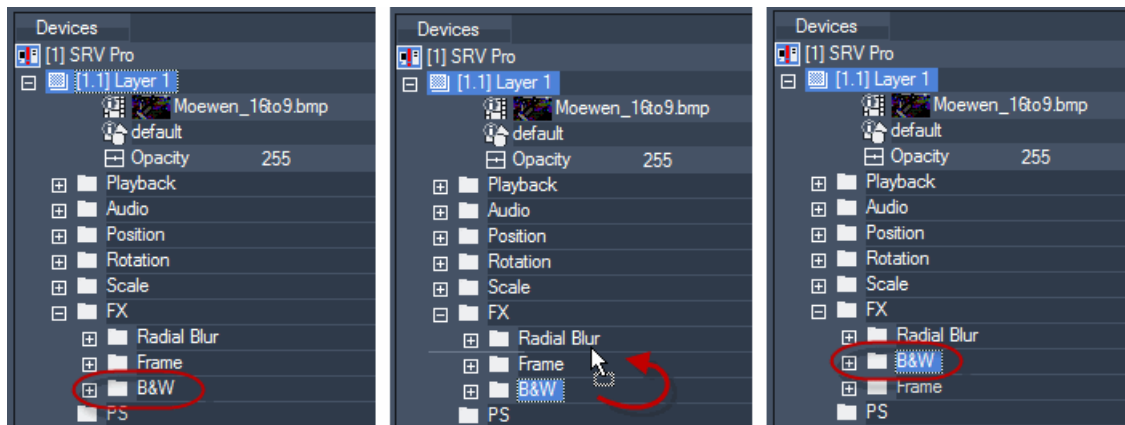

Image sequence above: the effect B&W is moved from the end of the effect chain into the middle.

### 5.4.2.11.3 FX PARAMETER

Depending on your chosen effect different parameters can be set.

One parameter that all of the FX have in common is the “Mix” parameter.

It defines how much the effect is mixed to the image / video file.

As long as it is set to the value 0 the effect is not visible.

Setting it to 100% (value 255) completely applies the effect.

See here two FX as example for different parameters:

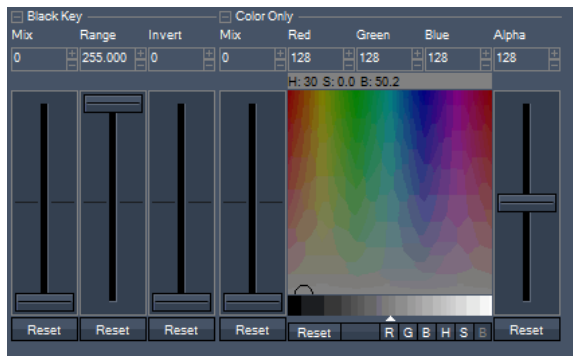

Most of the FX consist of parameters that can be set by fader controls (see the Black Key in the image above). Some FX allow setting RGB values by an colour picker (see the Color Only effect in the image above).

How to use the Color Picker

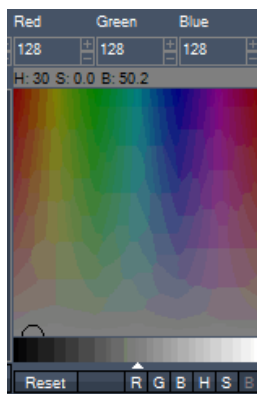

The Color Picker is based on the RGB (Red, Green, Blue) color model, including faders for HSB (Hue, Saturation, Brightness).

You might set the desired color by entering the values for red, green and blue manually above the color field. Note that the bar between the field and the values show the corresponding values for HSB and is colored in the chosen color instantly. If you want to see the color in the color field (marked with a black outlined circle, click the white arrow.

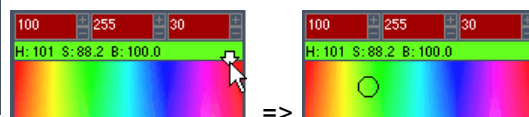

Another way is clicking on the desired parameter at the bottom of the color picker (R,G,B,H,S or B) and using the little horizontal fader right above the parameter or picking a color directly from the color field.

### 5.4.2.11.4 COPY / PASTE OF FX

There are a few things worth to know about the behavior when copying and pasting FX / clip containers including FX

#### COPY AND PASTE THE FX STRUCTURE

If there are one or several effects added to a layer and another layer should get this effect structure, right-click on the layer in the Device Tree and choose “Copy FX Structure”. Now right-click on the layer to which you want to paste this FX structure and choose “Paste FX Structure”.

#### Example:

Layer 1 contains 3 effects, in the order “Crop Edges INV”, “Cropper HV RGBA” and “Frame RGBA”. Layer 2 contains 2 effects, in the order “Frame RGBA” and “Softborder”, see images below.

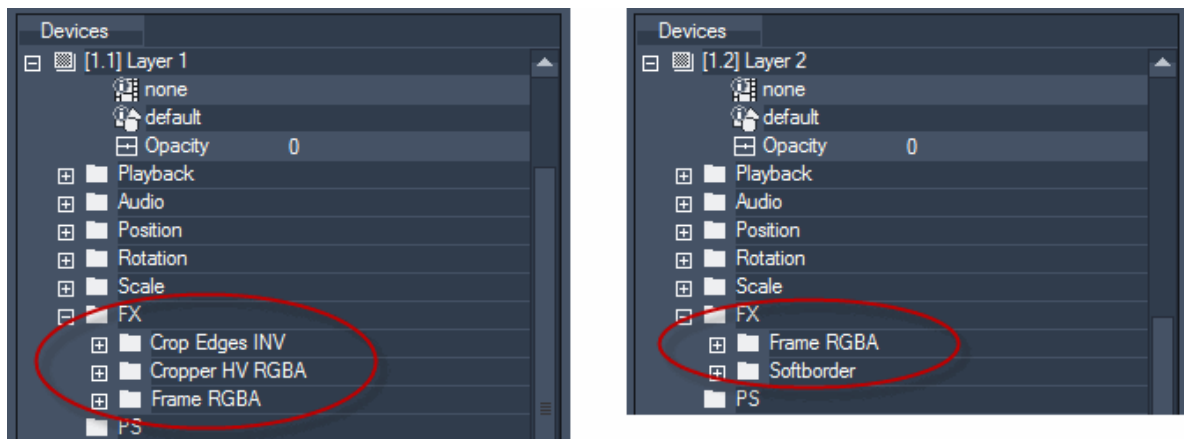

Images: Left) Layer 1 contains 3 effects, Right) Layer 2 contains 2 effects.

To copy the effect structure of Layer 1 to Layer 2, right-click on Layer 1 and choose “Copy FX Structure”. After this right-click on Layer 2 and choose “Paste FX Structure”, see images below.

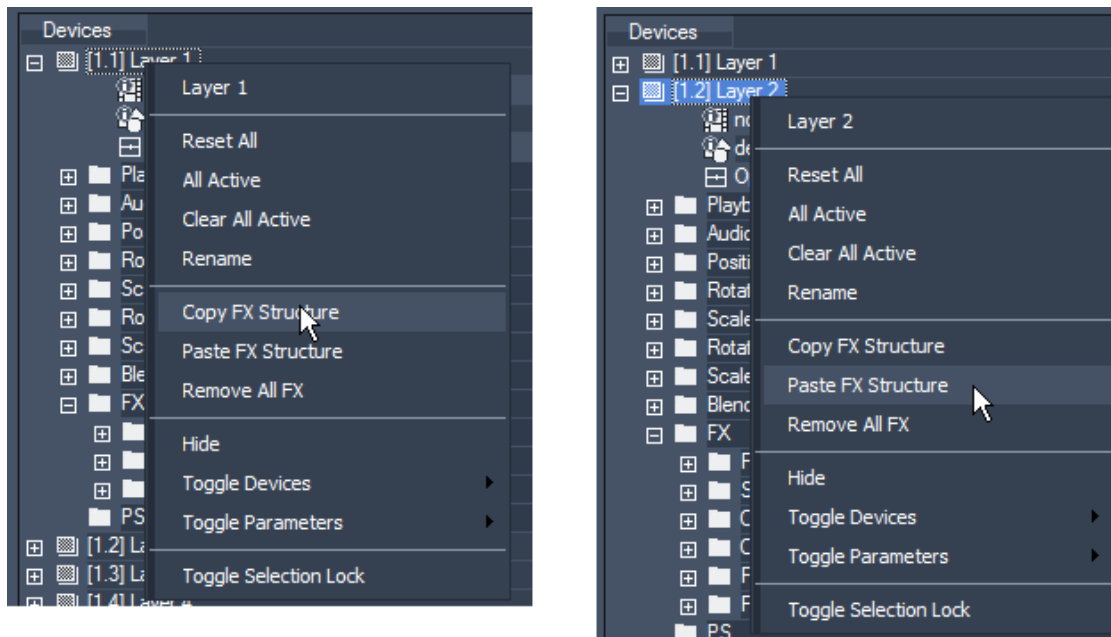

Images: Left) Copying the FX structure from Layer 1 and Right) pasting it to Layer 2 via the Device Context Menu.

The FX structure of Layer 2 includes the FX that were on Layer 2 before the Copy+Paste command was executed and the newly pasted FX coming from Layer 1, see image below.

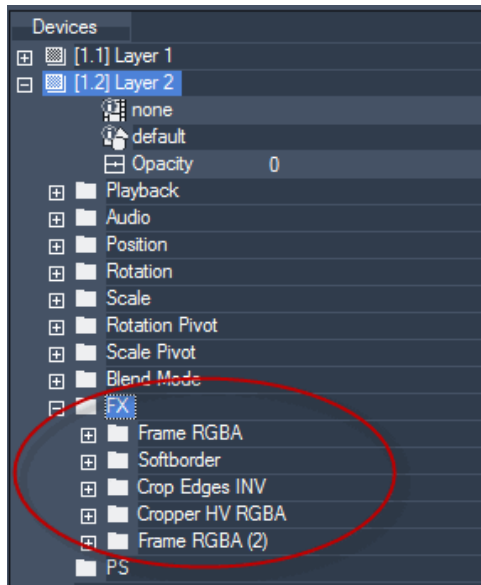

Image above: Layer 2 now contains the 2 old FX and the 3 newly added FX.

### COPY AND PASTE CLIP CONTAINERS

When copying a clip container from one layer (containing several FX) to another layer (containing FX as well, but different ones or in a different order) it depends on the settings within the clip container how the FX structure in the target layer will look like.

#### Example A:

Layer 1 contains 3 effects, in the order “Crop Edges INV”, “Cropper HV RGBA” and “Frame RGBA”. Layer 2 contains 2 effects, in the order “Frame RGBA” and “Softborder”, see images below.

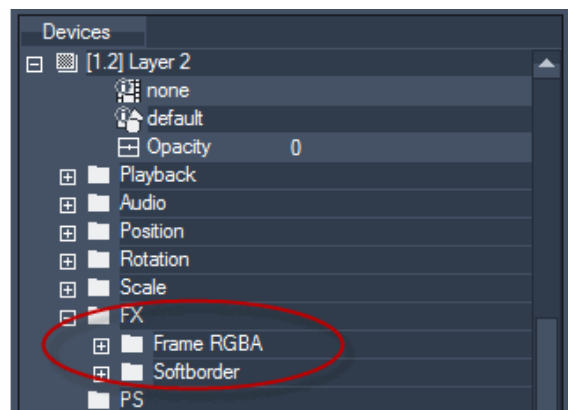
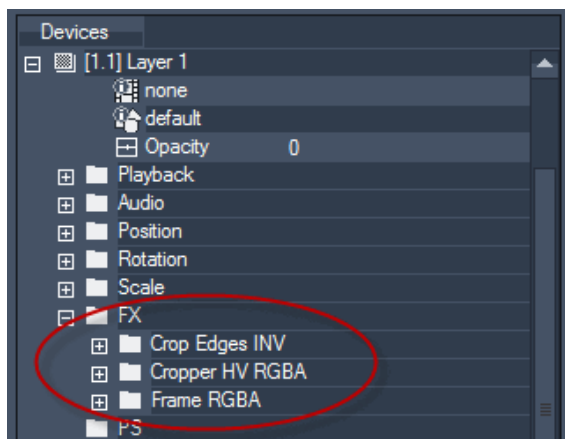

Images: Left) Layer 1 contains 3 effects, Right) Layer 2 contains 2 effects.

The clip that should be copied from Layer 1 to Layer 2 has keys set for the first FX (Crop Edges INV). The following 2 FX are not used in this clip container, see image below.

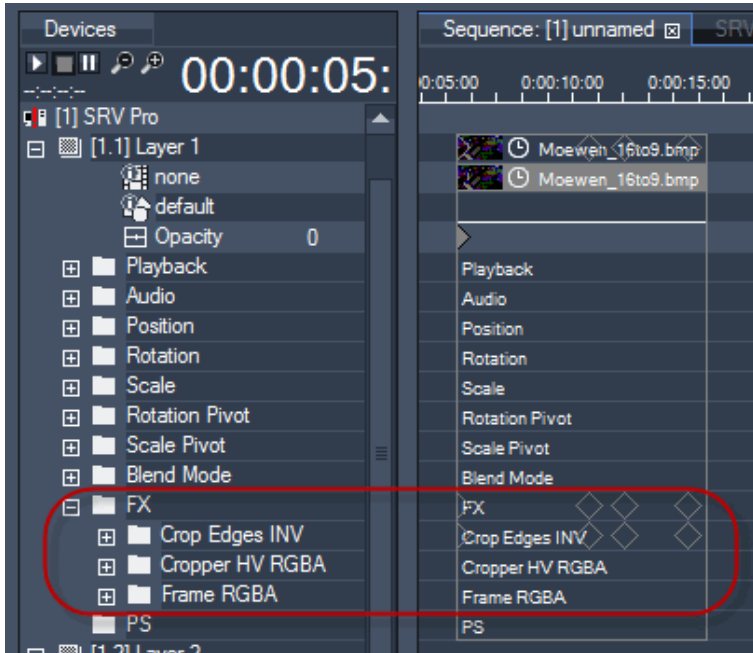

Image: The clip container on Layer 2 uses only the first FX, effect 2 and 3 have no keys set.

When this clip container now is pasted on Layer 2, only the FX “Crop Edges INV” will be pasted as well. The other two FX won’t be pasted because they were not used in the clip container, see image below.

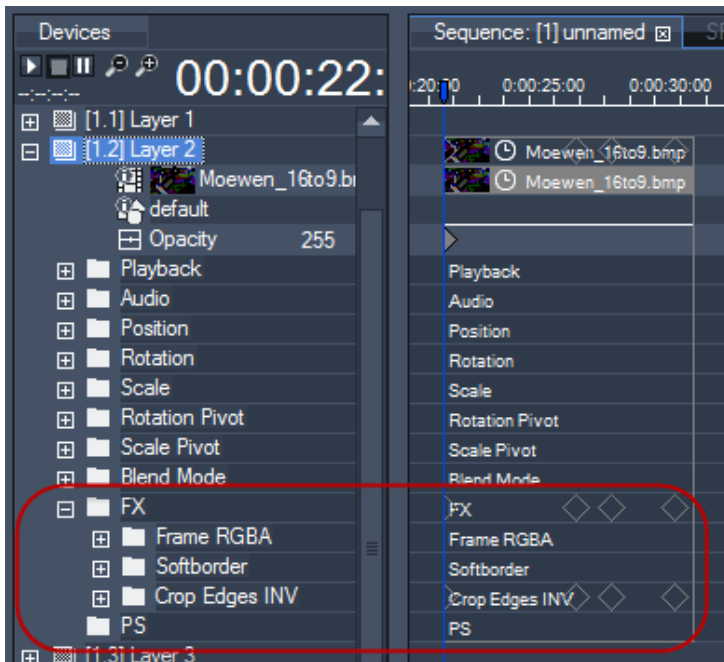

Image: After pasting the clip container to Layer 2, only the effect “Crop Edges INV” is added.

**Example B:**

The same FX structure of Layer 1 and Layer 2 is used, but now the clip container that is going to be pasted on Layer 2 has keys set for all three FX, see image below.

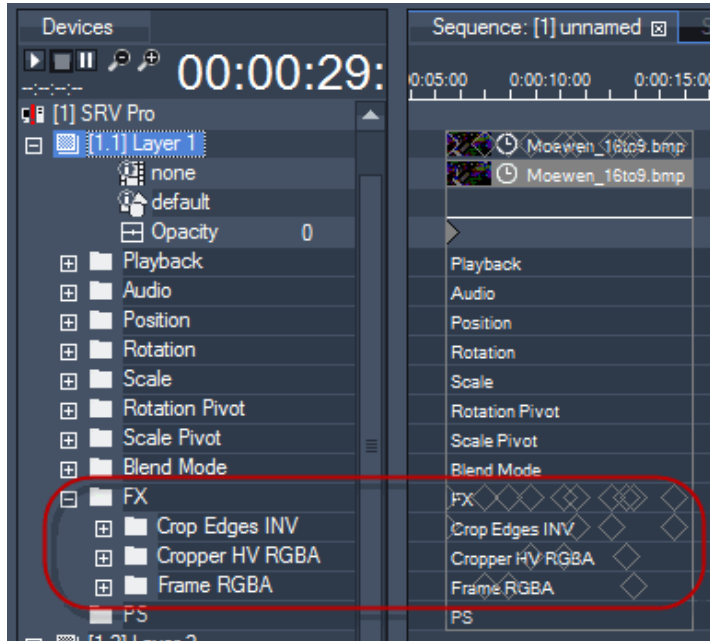

Image: The clip container on Layer 1 uses all three FX that are added to the layer.

When this clip container now is pasted on Layer 2, all FX from Layer 1 are added to the FX tree of Layer 2, see image below.

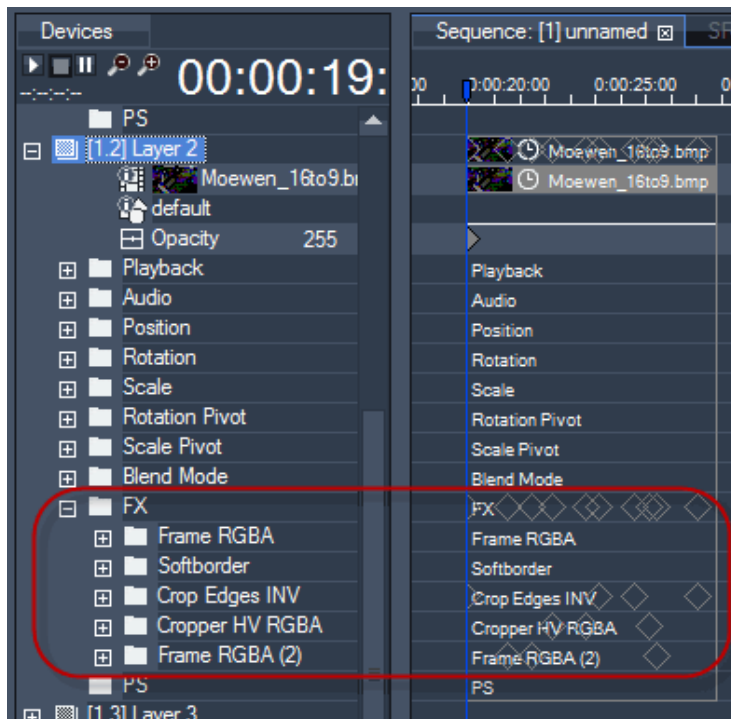

Image: After pasting the clip container to Layer 2, all effects from Layer 1 are added to the FX tree of Layer 2.

### 5.4.2.11.5 REMOVING FX

Please be careful with removing FX from layers!

Once an effect is removed from the layer, it won't be available any more for all of the layer's clip containers which used this effect.

There are several ways to remove an effect from a layer

- Right-click on the effect's name in the Device Control tab and choose "Remove FX" or "Remove All FX", see image left.
- Right-click on the effect's name in the Device Tree tab and choose "Remove", see image in the middle.
- Right-click on the layer in the Device Tree tab and choose "Remove All FX", see image right.

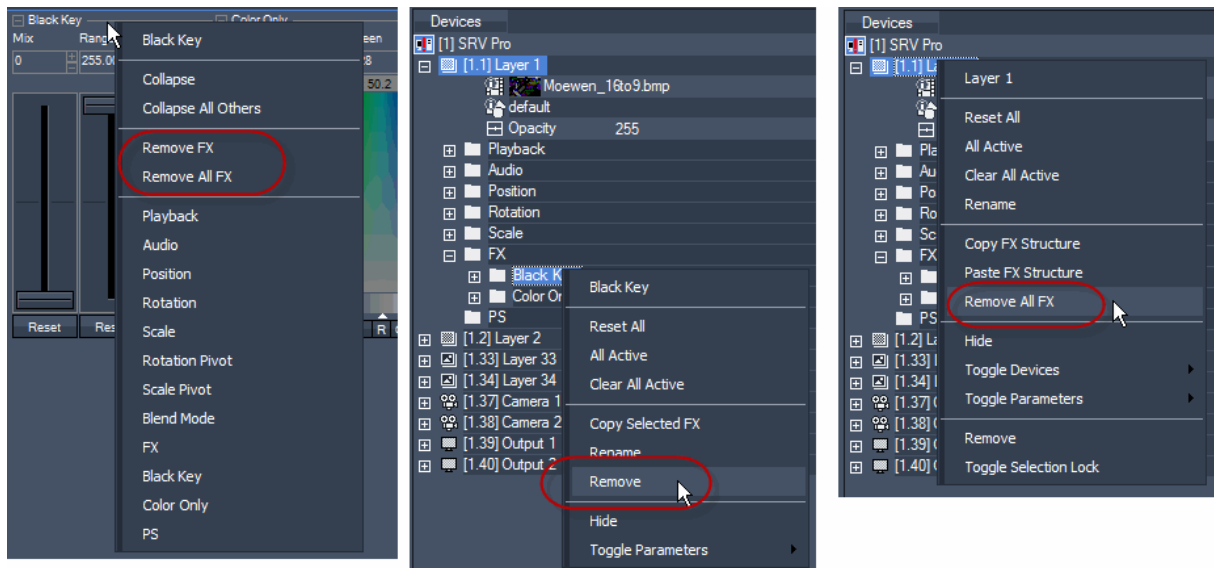

### 5.4.2.11.6 FX LIST

The following tables will list all effects in the order of their according FX theme collection. In addition the tables give an overview of the effect's availability regarding the different PB products.

### 5.4.2.11.7 ANIMATION

#### ▼ Rain



Adds animated raindrops.

Parameter	Description	Value Range	Default
Mix	Level of Effect	0-255	0



SpeedX	Speed of Rain horizontal	0-65535	32768
SpeedY	Speed of Rain vertical	0-65535	32768
Size	Size of raindrops	0-65535	32768

**5.4.2.11.8 ANTI-ALIASING**

▼ **Anti-Aliasing 1**

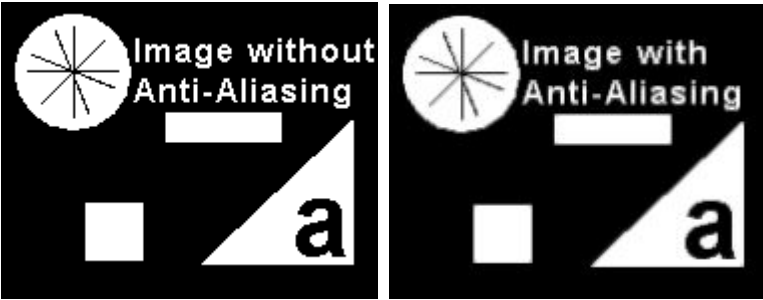

All anti-aliasing effects improve the image quality by smoothing pixelated or jagged edges within the image. There are various methods to achieve this. This anti-aliasing effect applies an directionally localized anti-aliasing (DLAA) algorithm that you can adjust with a "Mix" parameter. An alternative to anti-aliasing are the [Blur<sup>330</sup>](#) effects, especially the downsampling ones.

Parameter	Description	Value Range	Default
Mix	Level of effect itself	0-255	0

▼ **Anti-Aliasing 2**



All anti-aliasing effects improve the image quality by smoothing pixelated or jagged edges within the image. There are various methods to achieve this. This anti-aliasing effect applies a normal filter anti-aliasing (NFAA) algorithm that you can adjust with a "Mix" and "Scale" parameter. An alternative to anti-aliasing are the [Blur<sup>330</sup>](#) effects, especially the downsampling ones.

Parameter	Description	Value Range	Default
Mix	Level of effect itself	0-255	0
Scale	Scale	0-1000	250

▼ Anti-Aliasing 3



All anti-aliasing effects improve the image quality by smoothing pixelated or jagged edges within the image. There are various methods to achieve this. This anti-aliasing effect applies a super sampling anti-aliasing (SSAA) algorithm that you can adjust with a "Mix", "Width" and "Softness" parameter. An alternative to anti-aliasing are the [Blur](#)<sup>330</sup> effects, especially the downsampling ones.

Parameter	Description	Value Range	Default
Mix	Level of effect itself	0-255	0
Width	Width	0-1000	175
Softness	Softness	0-1000	250

5.4.2.11.9 BLUR

▼ Blur - Downsampling 1

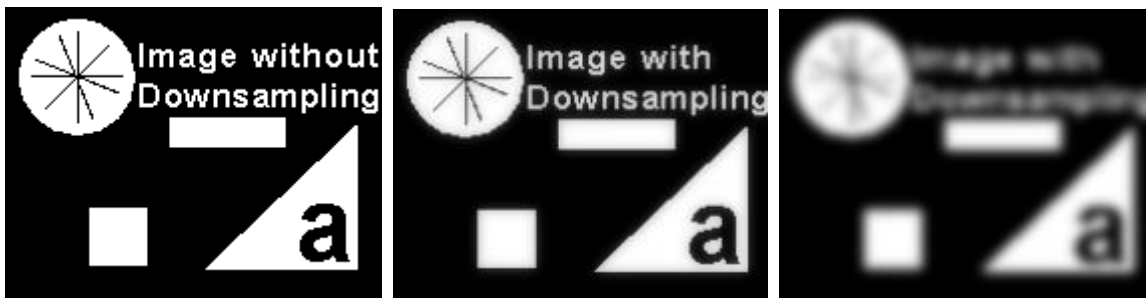

All Downsampling effects improve the image quality by smoothing pixelated or jagged edges within the image and can be used alternatively to an [anti-aliasing effect](#)<sup>329</sup>. This applies a downsampling blur algorithm with a texture resolution of 75%. The middle image shows the effect with the "Mix" set to a third, in the last image it is set to full.

Parameter	Description	Value Range	Default
Mix	Level of effect itself	0-255	0

▼ **Blur - Downsampling 2**

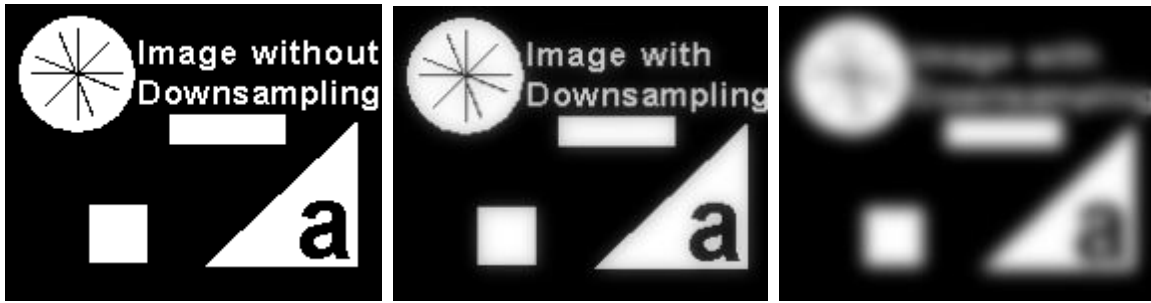

All Downsampling effects improve the image quality by smoothing pixelated or jagged edges within the image and can be used alternatively to an [anti-aliasing effect](#)<sup>329</sup>. This applies a downsampling blur algorithm with a texture resolution of 50%. The middle image shows the effect with the "Mix" set to a third, in the last image it is set to full.

Parameter	Description	Value Range	Default
Mix	Level of effect itself	0-255	0

▼ **Blur - Downsampling 3**



All Downsampling effects improve the image quality by smoothing pixelated or jagged edges within the image and can be used alternatively to an [anti-aliasing effect](#)<sup>329</sup>. This applies a downsampling blur algorithm with a texture resolution of 25%. The middle image shows the effect with the "Mix" set to a third, in the last image it is set to full.

Parameter	Description	Value Range	Default
Mix	Level of effect itself	0-255	0

▼ **Blur XY Alpha Glow Color**

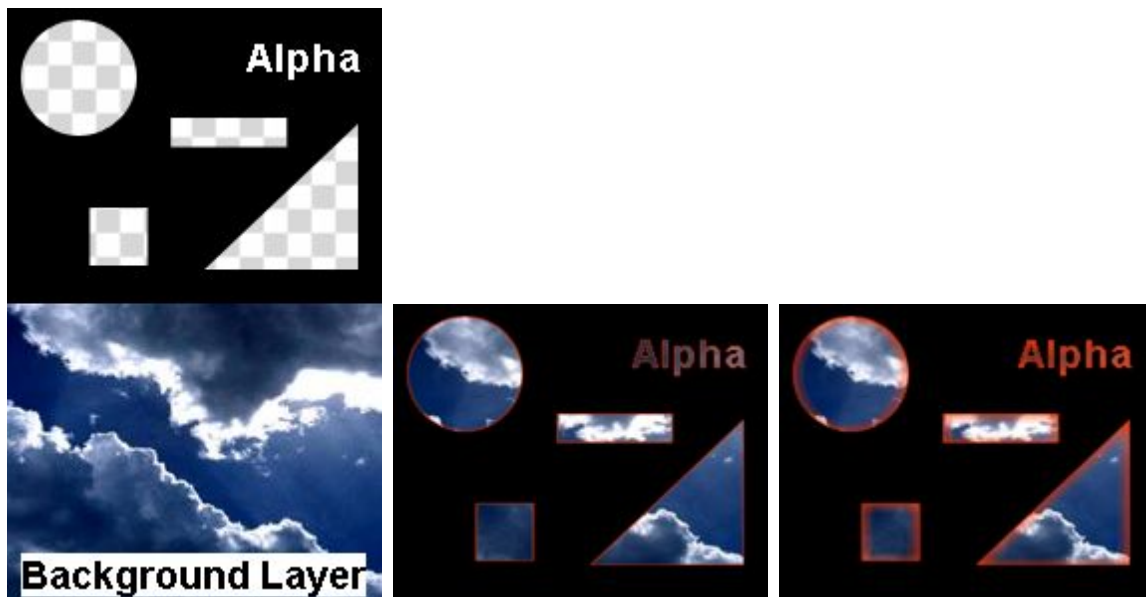

Overlays those pixels of the layer that are alpha (transparent) and adjacent to opaque (non see-through) pixels. The overlay line can be colored and blurred which creates the impression of a glowing line. You can adjust the amount as well es the X- and Y-offset of the blur.

Parameter	Description	Value Range	Default
Mix	Level of effect itself	0-255	0
Amount	Amount	0-255	32
X	X Offset	0-255	255
Y	Y Offset	0-255	255
Red	Color picker / Level of red	0-255	128
Green	Color picker / Level of green	0-255	128
Blue	Color picker / Level of blue	0-255	128

▼ **Blur XY Alpha Glow Pre-Multiplied**

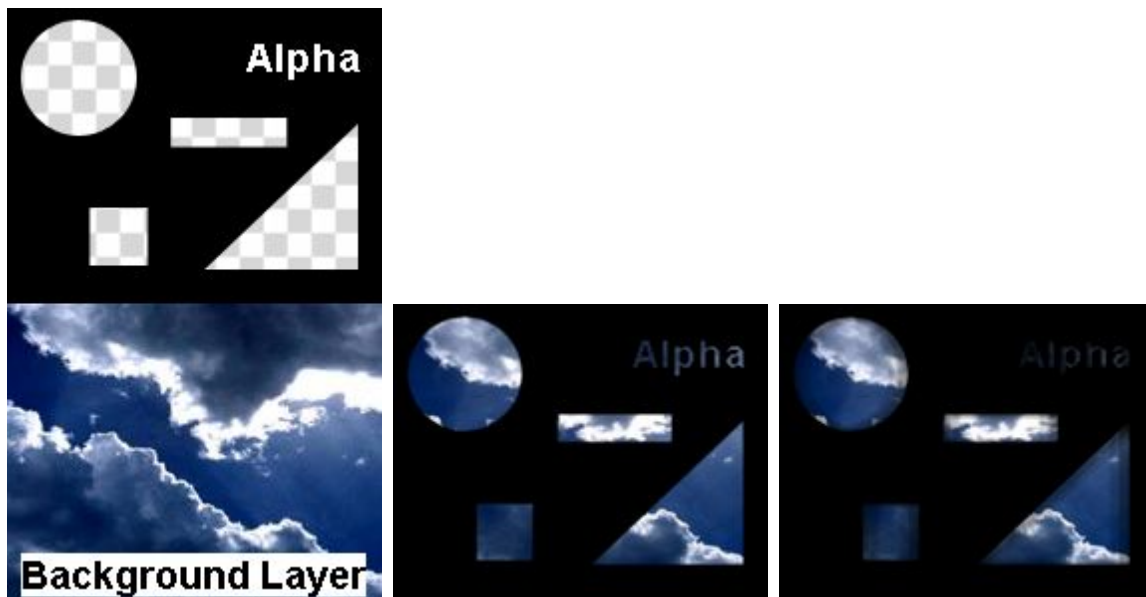

Overlays those pixels of the layer that are alpha (transparent) and adjacent to opaque (non see-through) pixels. In difference to the above effect "[Blur XY Alpha Glow Color](#)"<sup>332</sup> the overlay is simply black. You can adjust the amount as well es the X- and Y-offset of the blur.

Parameter	Description	Value Range	Default
Mix	Level of effect itself	0-255	0
Amount	Amount	0-255	32
X	X Offset	0-255	255
Y	Y Offset	0-255	255

▼ **Blur XY Alpha**

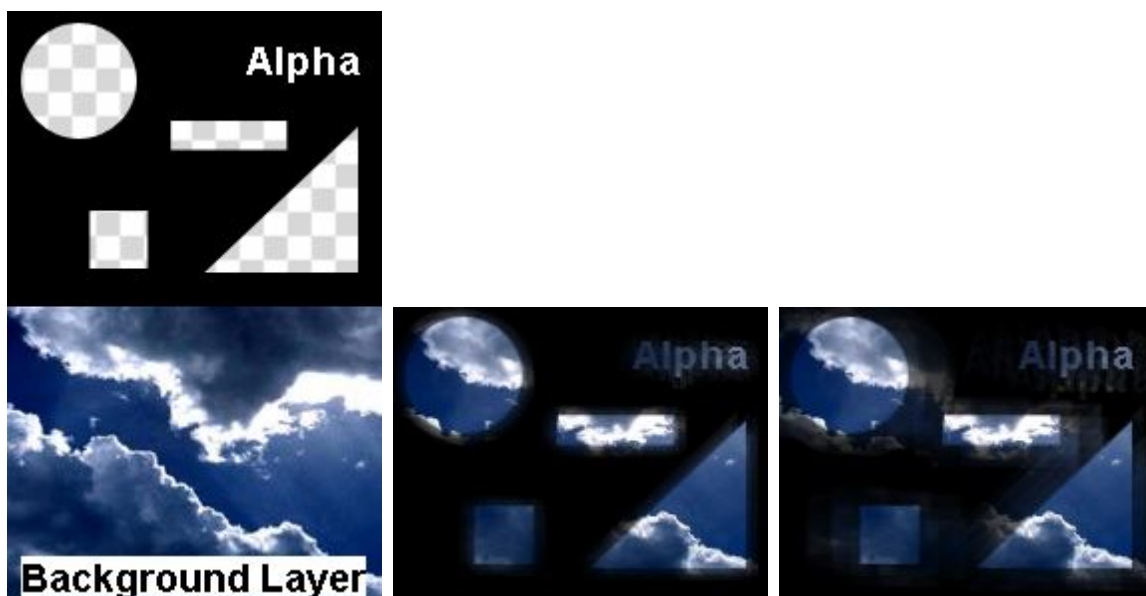

Blurs the alpha (transparent) areas of the layer, all opaque (non see-through) areas stay sharp. You can adjust the amount as well es the X- and Y-offset.

Parameter	Description	Value Range	Default
Mix	Level of effect itself	0-255	0
Amount	Amount	0-255	132
X	X Offset	0-255	132
Y	Y Offset	0-255	122

▼ **Blur XY**



Blurs all RGBA pixels of the layer. You can adjust the amount as well as the X- and Y-offset.

Parameter	Description	Value Range	Default
Mix	Level of Effect	0-255	0
Amount	Amount of Blur	0-255	132
X	X Offset	0-255	132
Y	Y Offset	0-255	122

▼ **Dilate Alpha**

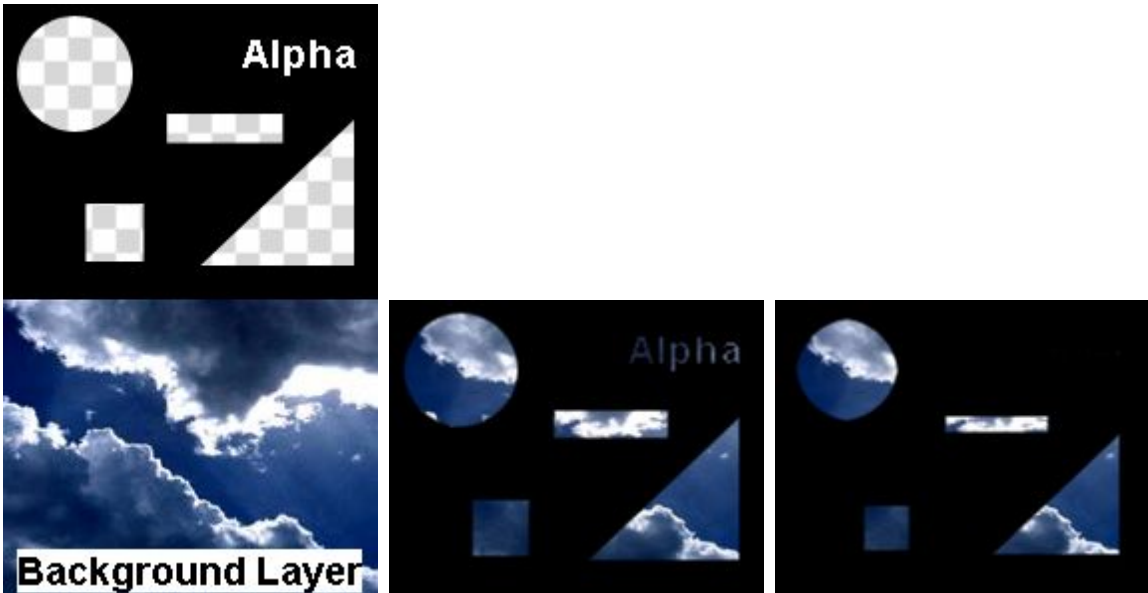

This effect looks for opaque (non see-through) areas of the layer that are (partially) surrounded by alpha (transparent) areas. Then it enlarges the size of the opaque areas according to the "Amount" parameter by repeating the opaque pixels.

This effect might be of interest when working with a generated mask (e.g. keying a specific color) and there are small areas left that should be either transparent or opaque. This appears as so called noise. A combination of a dilate and erode effect can reduce the noise.

Parameter	Description	Value Range	Default
Mix	Level of effect itself	0-255	0
Amount	Amount	0-255	132

▼ Dilate



This effect looks for areas in the layer that are brighter than those areas that (partially) surrounded them. Then it enlarges their size according to the "Amount" parameter by repeating the brighter pixels.

This effect might be of interest when working with a generated mask (e.g. coloring regions of interest in black or white) and there are small areas left that should be the opposite color. This appears as so called noise. A combination of a dilate and erode effect can reduce the noise.

Parameter	Description	Value Range	Default
Mix	Level of effect itself	0-255	0
Amount	Amount	0-255	132

▼ Erode Alpha

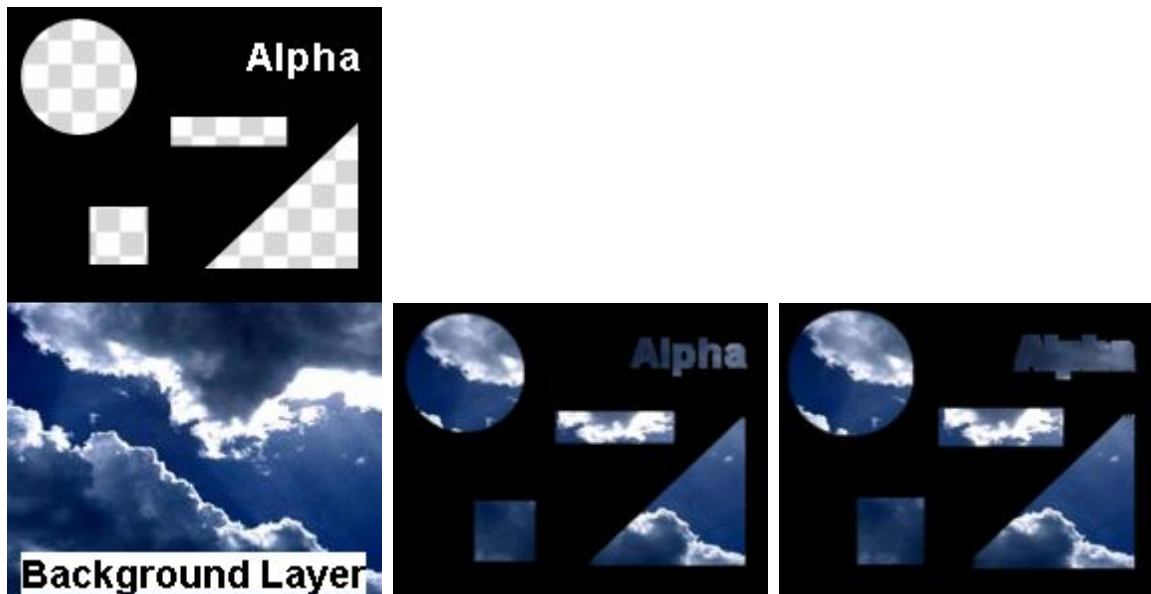

This effect looks for opaque (non see-through) areas of the layer that are (partially) surrounded by alpha (transparent) areas. Then it reduces the size of the opaque areas according to the "Amount" parameter by repeating the adjacent transparent pixels.

This effect might be of interest when working with a generated mask (e.g. keying a specific color) and

there are small areas left that should be either transparent or opaque. This appears as so called noise. A combination of a dilate and erode effect can reduce the noise.

Parameter	Description	Value Range	Default
Mix	Level of effect itself	0-255	0
Amount	Amount	0-255	132

▼ Erode



This effect looks for areas in the layer that are darker than those areas that (partially) surrounded them. Then it enlarges their size according to the "Amount" parameter by repeating the darker pixels.

This effect might be of interest when working with a generated mask (e.g. coloring regions of interest in black or white) and there are small areas left that should be either black or white. This appears as so called noise. A combination of a dilate and erode effect can reduce the noise.

Parameter	Description	Value Range	Default
Mix	Level of effect itself	0-255	0
Amount	Amount	0-255	132

▼ GaussianBlur On-Off



This is a switchable Gaussian Blur effect.

Parameter	Description	Value Range	Default
On/Off	On/Off	-	-
Blur	Blur	0-100	0



▼ GaussianBlur



This adds a Gaussian Blur effect to the layer.

Parameter	Description	Value Range	Default
Blur	Blur	0-100	0

▼ Glow



This effect looks for bright pixels in the layer texture and adds brightness to surrounding pixels, thus they appear to glow.

Parameter	Description	Value Range	Default
Mix	Level of effect itself	0-255	0
Luminance	Luminance	0-65535	60000
Mid	Mid	0-255	46
Cut-Off	Cut-Off	0-255	200
Bloom	Bloom	0-255	190
Red	Color picker / Level of red	0-255	255
Green	Color picker / Level of green	0-255	255
Blue	Color picker / Level of blue	0-255	255

▼ Radial Blur Alpha Color

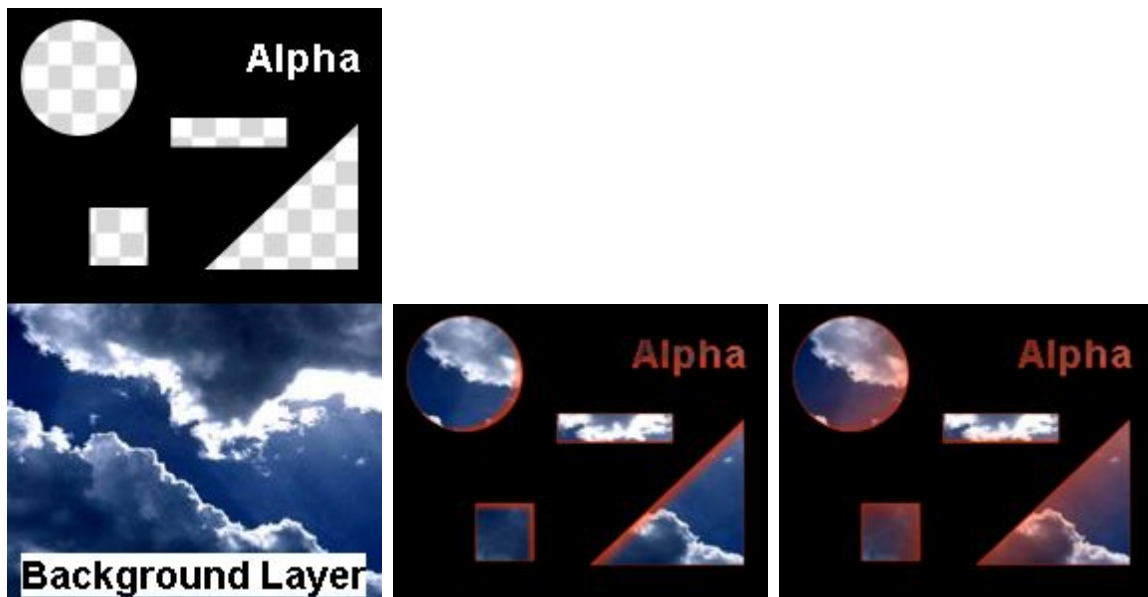

Overlays those pixels of the layer that are alpha (transparent) and adjacent to opaque (non see-through) pixels. The overlay line can be colored and blurred with a radial blur which creates the impression of a glowing shadow in one direction. You can adjust the amount as well as the X- and Y-direction and the intensity of the radial blur.

Parameter	Description	Value Range	Default
Mix	Level of effect itself	0-255	0
Amount	Amount	0-255	64
X	X	0-65535	32768
Y	Y	0-65535	32768
Intensity	Intensity	0-255	128
Red	Color picker / Level of red	0-255	128
Green	Color picker / Level of green	0-255	128
Blue	Color picker / Level of blue	0-255	128

▼ Radial Blur Alpha

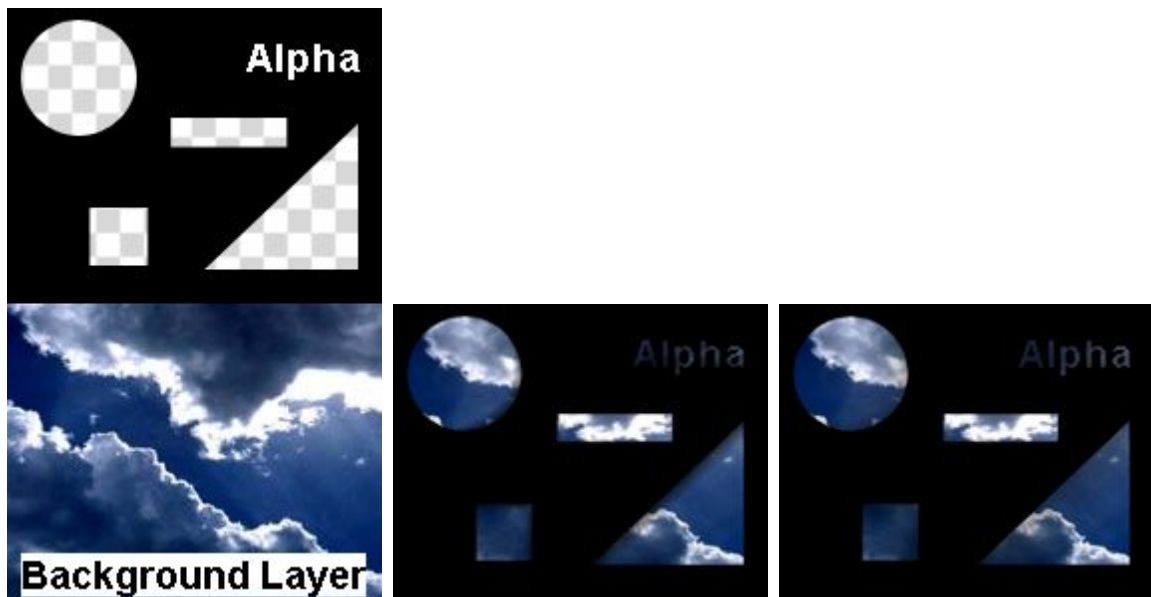

Blurs the alpha (transparent) areas of the layer with a radial blur effect. All opaque (non see-through) areas stay sharp. You can adjust the amount as well as the X- and Y-direction and the intensity of the radial blur.

Parameter	Description	Value Range	Default
Mix	Level of effect itself	0-255	0
Amount	Amount	0-255	64
X	X Direction	0-65535	32768
Y	Y Direction	0-65535	32768
Intensity	Intensity	0-255	128

▼ Radial Blur



Blurs all RGBA pixels of the layer with a radial blur. You can adjust the amount as well as the X- and Y-direction and the intensity.

Parameter	Description	Value Range	Default
Mix	Level of Effect	0-255	0
Amount	Amount of Blur	0-255	64
X	X Position of Center Point	0-65535	32768
Y	Y Position of Center Point	0-65535	32768
Intensity	Amount of Blur	0-255	128

▼ Refresh Delay

This adds a delay of one frame when applied to any [Output device](#)<sup>597</sup>. This is of interest when working with multiple displays that are mounted underneath each other and have a hard edge. With sensitive displays and sensitive content it can look better when the second signal is delayed by one frame which is the time it takes to process the first frame.

Note that this effect can not be applied twice to an Output to generate an delay of two frames!

Parameter	Description	Value Range	Default
Mix	Level of effect itself	0-255	255

▼ Render Delay

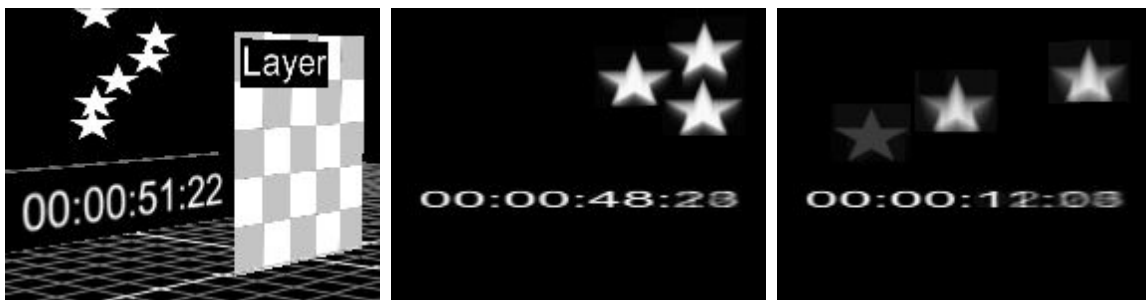

This effect is based on the Layer's Z Position or render history as explained in the manual chapter ["Compositing"](#)<sup>386</sup>. The layer with the assigned "Render Delay" effect makes a composition of all layers behind it. In the example, the "render" layer is positioned in the foreground, its main media is a transparent image. In the background there is a layer with a running timecode video and a [particle system](#)<sup>182</sup> (also with a transparent media!).

All background pixels are delayed depending on the effect parameter "Delay".

Parameter	Description	Value Range	Default
Mix	Level of Effect	0-255	0
Delay	Amount of Delay	0-65535	32768

▼ Render Draw Media



This effect is based on the Layer's Z Position or render history as explained in the manual chapter ["Compositing"](#)<sup>386</sup>. The layer with the assigned "Render Draw Media" effect makes a composition of all layers behind it. In the example, the "render" layer is positioned in the foreground, its main media is a transparent image whilst the effect's media is a rainbow image. In the background there is a

grass layer and a [particle system](#)<sup>182</sup> (also with a transparent media!). Depending on the effect parameter "Clear" the background pixels add up to the foreground texture. E.g. the particle's movement draws onto the rainbow effect texture; the second image shows a low "Clear", the third an increased "Clear" time. Another drawing result could be achieved by moving the grass layer up and down or by using a video with moving pixels.

Parameter	Description	Value Range	Default
Mix	Level of effect itself	0-255	255
Clear	Clear	0-65535	32768
Media	Media file as source for overlay or mask	-	-

▼ **Render Draw**



This effect is based on the Layer's Z Position or render history as explained in the manual chapter "[Compositing](#)"<sup>386</sup>. The layer with the assigned "Render Draw Media" effect makes a composition of all layers behind it. In the example, the "render" layer is positioned in the foreground, its main media is a transparent image. In the background there is a grass layer and a [particle system](#)<sup>182</sup> (also with a transparent media!).

Depending on the effect parameter "Clear" the background pixels add up to the foreground texture. The particle's movement draws onto the transparent layer texture; the second image shows a low "Clear", the third an increased "Clear" time. Another drawing result could be achieved by moving the grass layer up and down or by using a video with moving pixels.

Parameter	Description	Value Range	Default
Mix	Level of Effect	0-255	0
Clear	Clears drawn areas	0-65535	32768

▼ **Video Delay**



Delays a Video File as if it blends over several frames.

Parameter	Description	Value Range	Default
Mix	Level of Effect	0-255	0

Delay	Amount of delay	0-65535	60000
-------	-----------------	---------	-------

### 5.4.2.11.10 CAMERA PROJECTION

#### ▼ Perspective Projection Mapping



This effect is the only one that can (and must) be applied to a [Camera layer](#)<sup>589</sup>. It allows special tracking setups, e.g. when a camera movement is tracked for a real/virtual TV studio setup. According to the (real) movement of the camera Pandoras Box renders a cut-out of a virtual space which is then displayed as a background in the (real) setup. Therefore it is seen by the (real) camera which results in a recorded mix of real and virtual elements. Only from the real camera's viewpoint the background is in the correct perspective. This setup is an alternative to keying applications with a green or blue screen.

The tracking data changes the parameters of a PB camera layer. The effect parameters on the other hand are static, i.e they are setup once as fixed values. The four coordinates represent the corners of the screen whereon the background is projected and can also be understood as a "window" through which the (PB) camera sees and renders the background.

An example for this effect is the setup of the coolux booth on NAB 2013 seen here: <https://www.youtube.com/watch?v=7ectw1Z9BvA>

Parameter	Description	Value Range	Default
GenPerspTargetPt1X	GenPerspTargetPt1X	-999.999-999.999	-8
GenPerspTargetPt1Y	GenPerspTargetPt1Y	-999.999-999.999	-5
GenPerspTargetPt1Z	GenPerspTargetPt1Z	-999.999-999.999	0
GenPerspTargetPt2X	GenPerspTargetPt2X	-999.999-999.999	8
GenPerspTargetPt2Y	GenPerspTargetPt2Y	-999.999-999.999	-5
GenPerspTargetPt2Z	GenPerspTargetPt2Z	-999.999-999.999	0
GenPerspTargetPt3X	GenPerspTargetPt3X	-999.999-999.999	-8
GenPerspTargetPt3Y	GenPerspTargetPt3Y	-999.999-999.999	5
GenPerspTargetPt3Z	GenPerspTargetPt3Z	-999.999-999.999	0

### 5.4.2.11.11 COLOR EFFECTS

#### ▼ B&W Add

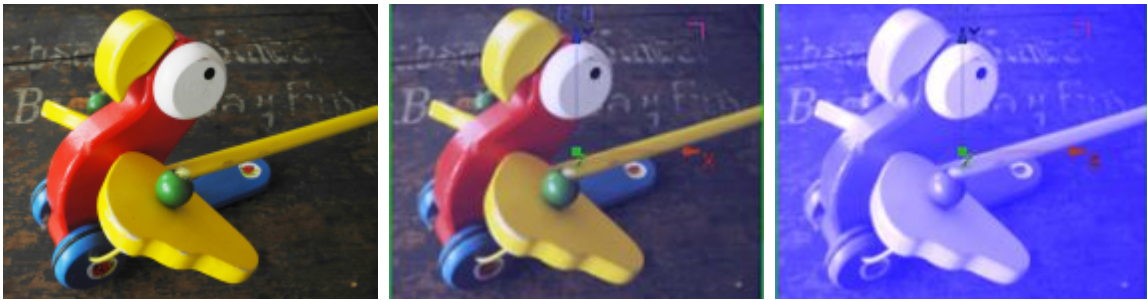

Adds Black and White values to the RGB colors, the result can be inverted. Uses the color picker, with saturation set to 0 by default.

Parameter	Description	Value Range	Default
Mix	Level of Effect	0-255	0
Red	Color Picker	0-255	128
Green	Color Picker	0-255	128
Blue	Color Picker	0-255	128
Invert	Inverts the RGB levels	0-255	0

#### ▼ B&W Multiply



All RGB colors are multiplied by B&W color mix value, the result can be inverted. Uses the color picker, with saturation set to 0 by default.

Parameter	Description	Value Range	Default
Mix	Level of Effect	0-255	0
Red	Color Picker	0-255	128
Green	Color Picker	0-255	128
Blue	Color Picker	0-255	128
Factor	Color Multiply Factor	0-255	64
Invert	Inverts the RGB levels	0-255	0

▼ **B&W**

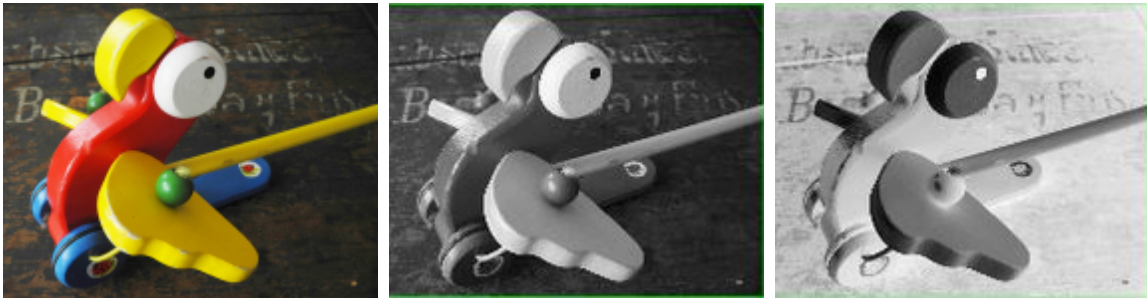

Turns the RGB image into Black and White, the result can be inverted.

Parameter	Description	Value Range	Default
Mix	Level of Effect	0-255	0
Invert	Inverts the RGB Levels	0-255	128

▼ **BiTone**



Turns the RGB image into just two colors, using Threshold. Both colors can be set by color pickers.

Parameter	Description	Value Range	Default
Mix	Level of Effect	0-255	0
Red 1	Color Picker for Color 1	0-255	255
Green 1	Color Picker for Color 1	0-255	255
Blue 1	Color Picker for Color 1	0-255	255
Red 2	Color Picker for Color 2	0-255	0
Green 2	Color Picker for Color 2	0-255	0
Blue 2	Color Picker for Color 2	0-255	0
Threshold	Defines the Threshold	0-255	128



▼ **BiTone Luma**



Colorizes the image based upon its luminance values in two colors, each for high (H) and low (L) levels, using color pickers.

Parameter	Description	Value Range	Default
Mix	Level of Effect	0-255	0
Red H	Color Picker for high luminance value	0-255	128
Green H	Color Picker for high luminance value	0-255	128
Blue H	Color Picker for high luminance value	0-255	128
Red L	Color Picker for low luminance value	0-255	128
Green L	Color Picker for low luminance value	0-255	128
Blue L	Color Picker for low luminance value	0-255	128

▼ **Color Stripes H**

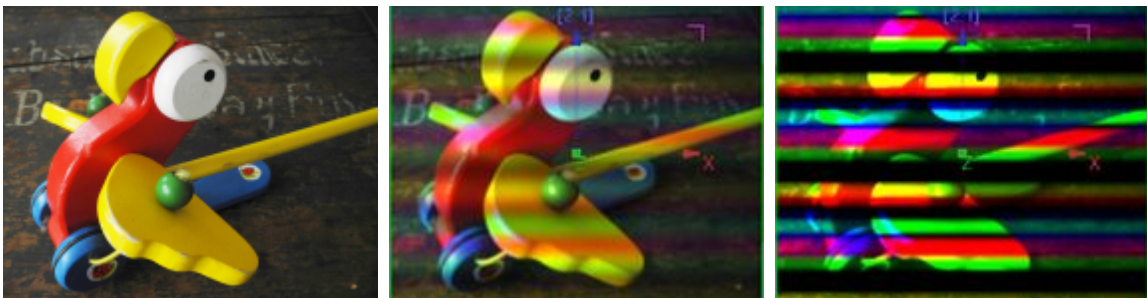

Adds horizontal colored stripes.

Parameter	Description	Value Range	Default
Mix	Level of effect itself	0-255	0
Amount	Amount	0-65535	1024

▼ **Color Stripes V**

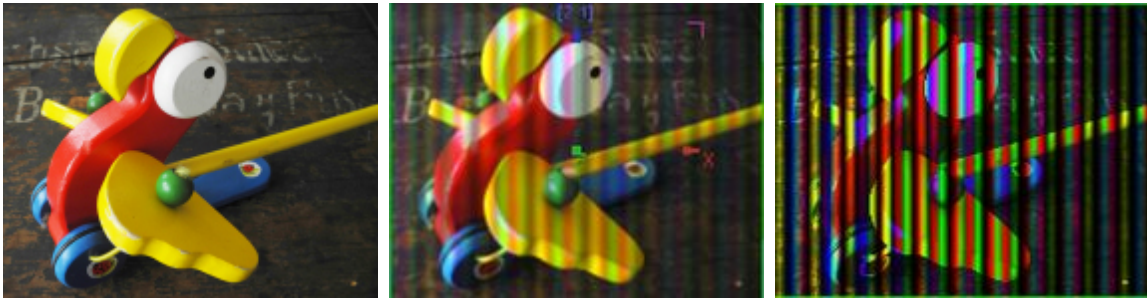

Adds vertical colored stripes.

Parameter	Description	Value Range	Default
Mix	Level of effect itself	0-255	0
Amount	Amount	0-65535	1024

▼ **ColorFade**



Fades all RGB colors to full RGB or CMY color saturation.

Parameter	Description	Value Range	Default
Mix	Level of Effect	0-255	0
R / C	Fades into Red (up) / Cyan (down)	0-255	128
G / M	Fades into Green (up) / Magenta (down)	0-255	128
B / Y	Fades into Blue (up) / Yellow (down)	0-255	128

▼ **ColorScroll Add**



Applies a color-changing effect to the layer texture by adding the RGB values.

Parameter	Description	Value Range	Default
Mix	Level of effect itself	0-255	0

Scroll Speed Scroll Speed 0-65535 0

▼ **ColorScroll Multiply**



Applies a color-changing effect to the layer texture by multiplying the RGB values.

Parameter	Description	Value Range	Default
Mix	Level of effect itself	0-255	0
Scroll Speed	Scroll Speed	0-65535	0

▼ **ColorScroll Only**



Applies a color-changing effect to the layer texture by overlaying the original RGB values.

Parameter	Description	Value Range	Default
Mix	Level of effect itself	0-255	0
Scroll Speed	Scroll Speed	0-65535	0

▼ **Emboss Angle**



Emboss with control for Factor and Angle.

Parameter	Description	Value Range	Default
Mix	Level of Effect	0-255	0

Factor	Amount of Emboss	0-255	128
Angle	Angle of Emboss	0-255	128

▼ **Emboss Edges**

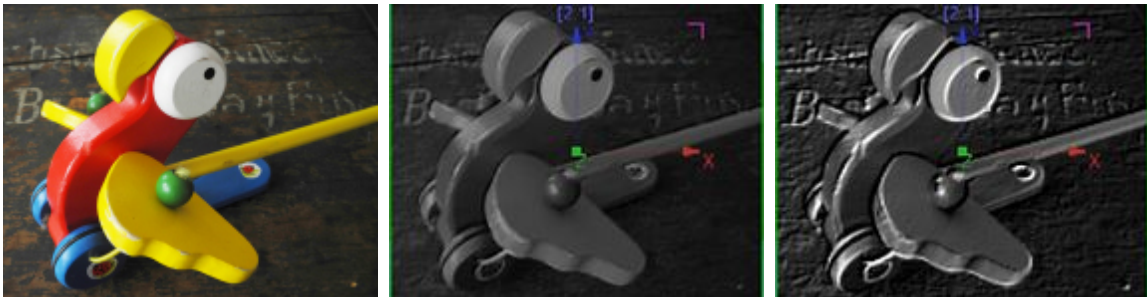

Emboss with control for Threshold.

Parameter	Description	Value Range	Default
Mix	Level of Effect	0-255	0
Threshold	Level of Threshold	0-255	128

▼ **Emboss**



Emboss with control for Threshold.

Parameter	Description	Value Range	Default
Mix	Level of Effect	0-255	0
Threshold	Level of Threshold	0-255	144
Factor	Factor of Emboss	0-255	196

▼ **Granite**



Granite Effect.

Parameter	Description	Value Range	Default
Mix	Level of Effect	0-255	0
Amount	Level of Granite pattern	0-255	255

▼ **Invert**



Inverts the RGB levels.

Parameter	Description	Value Range	Default
Mix	Level of Effect	0-255	0

▼ **LinearLight**



Linear light reflexion over the whole image.

Parameter	Description	Value Range	Default
Mix	Level of Effect	0-255	0

▼ **RGB Inversion**



Inverts the RGB levels with the possibility of setting RGB levels, Threshold and Radius.

Parameter	Description	Value Range	Default
Mix	Level of Effect	0-255	0

Red	Red level, Color Picker	0-255	128
Green	Green level, Color Picker	0-255	128
Blue	Blue level, Color Picker	0-255	128
Threshold	Threshold	0-255	255
Radius	Radius	0-255	128
Invert	Inverts the applied effect.	0-255	0

▼ **Sepiatone**



Tints the texture in sepia tones, amount is adjustable.

Parameter	Description	Value Range	Default
Mix	Level of Effect	0-255	0
Amount	Amount of sepia tone	0-255	128

▼ **Solarize**

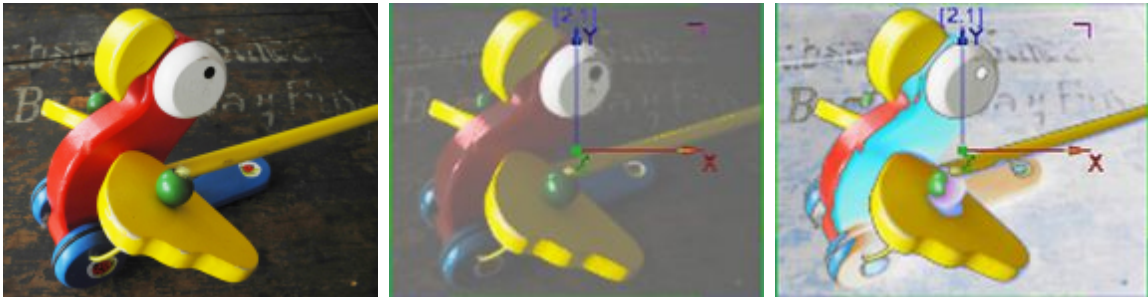

Solarize inverts first dark then brighter colors.

Parameter	Description	Value Range	Default
Mix	Level of Effect	0-255	0
Amount	Amount of solarization	0-255	128

▼ **Tone Mapping**

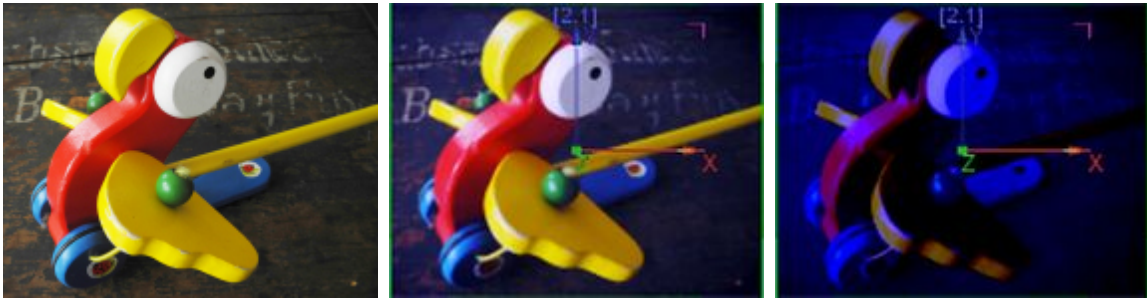

Allows to set Fog, Exposure, Gamma, Vignette and Blueshift to create specific photo style.

Parameter	Description	Value Range	Default
Mix	Level of Effect	0-255	0
Defog	Defog	0-255	2
Fog Red	Fog Red	0-255	255
Fog Green	Fog Green	0-255	255
Fog Blue	Fog Blue	0-255	255
Exposure	Exposure	0-255	144
Gamma	Gamma	0-255	32
VignetteCenter X	VignetteCenter X	0-65535	32768
VignetteCenter Y	VignetteCenter Y	0-65535	32768
VignetteRadius	VignetteRadius	0-65535	65535
VignetteAmount	VignetteAmount	0-65535	64
BlueShift	BlueShift	0-255	0

▼ **TriTone**



Colorizes the image based upon its luminance values in a mix of three colors, each for high (H), middle (M) and low (L) levels, using color pickers.

Parameter	Description	Value Range	Default
Mix	Level of Effect	0-255	0
Red H	Color Picker for high luminance value	0-255	128
Green H	Color Picker for high luminance value	0-255	128
Blue H	Color Picker for high luminance value	0-255	128
Red M	Color Picker for middle luminance value	0-255	128
Green M	Color Picker for middle luminance value	0-255	128
Blue M	Color Picker for middle luminance value	0-255	128

Red L	Color Picker for low luminance value	0-255	128
Green L	Color Picker for low luminance value	0-255	128
Blue L	Color Picker for low luminance value	0-255	128

**5.4.2.11.12 COLOR EFFECTS - CROP**

▼ **B&W Add Crop Pixel**



Applies the "B&W Add" FX within an adjustable rectangular area with hard edges. It adds Black and White values to the RGB colors, the result can be inverted. Uses the color picker, with saturation set to 0 by default.

Parameter	Description	Value Range	Default
Mix	Level of effect itself	0-255	0
Red	Color picker / Level of red	0-255	128
Green	Color picker / Level of green	0-255	128
Blue	Color picker / Level of blue	0-255	128
Invert	Inverts the RGB levels or the effect	0-255	0
Left (px)	Left (px)	0-8192	0
Right (px)	Right (px)	0-8192	0
Top (px)	Top (px)	0-8192	0
Bottom (px)	Bottom (px)	0-8192	0

▼ **B&W Crop Pixel**



Applies the "B&W" FX within an adjustable rectangular area with hard edges. It turns the RGB image into Black and White, the result can be inverted.

Parameter	Description	Value Range	Default
Mix	Level of effect itself	0-255	0
Invert	Inverts the RGB levels or the effect	0-255	0
Left (px)	Left (px)	0-8192	0



Right (px)	Right (px)	0-8192	0
Top (px)	Top (px)	0-8192	0
Bottom (px)	Bottom (px)	0-8192	0

▼ **B&W Multiply Crop Pixel**



Applies the "B&W Multiply" FX within an adjustable rectangular area with hard edges. All RGB colors are multiplied by B&W color mix value, the result can be inverted. Uses the color picker, with saturation set to 0 by default.

Parameter	Description	Value Range	Default
Mix	Level of effect itself	0-255	0
Red	Color picker / Level of red	0-255	128
Green	Color picker / Level of green	0-255	128
Blue	Color picker / Level of blue	0-255	128
Factor	Factor	0-255	64
Invert	Inverts the RGB levels or the effect	0-255	0
Left (px)	Left (px)	0-8192	0
Right (px)	Right (px)	0-8192	0
Top (px)	Top (px)	0-8192	0
Bottom (px)	Bottom (px)	0-8192	0

▼ **BiTone Crop Pixel**



Applies the "Bitone" FX within an adjustable rectangular area with hard edges. It turns the RGB image into just two colors, using Threshold. Both colors can be set by color pickers.

Parameter	Description	Value Range	Default
Mix	Level of effect itself	0-255	0
Red 1	First color picker / Level of red	0-255	255
Green 1	First color picker / Level of green	0-255	255
Blue 1	First color picker / Level of blue	0-255	255

Red 2	Second color picker / Level of red	0-255	0
Green 2	Second color picker / Level of green	0-255	0
Blue 2	Second color picker / Level of blue	0-255	0
Threshold	Threshold	0-255	128
Left (px)	Left (px)	0-8192	0
Right (px)	Right (px)	0-8192	0
Top (px)	Top (px)	0-8192	0
Bottom (px)	Bottom (px)	0-8192	0

▼ **BiTone Luma Crop Pixel**



Applies the "BiTone Luma" FX within an adjustable rectangular area with hard edges. It colorizes the image based upon its luminance values in two colors, each for high (H) and low (L) levels, using color pickers.

Parameter	Description	Value Range	Default
Mix	Level of effect itself	0-255	0
Red H	Color picker / Level of red	0-255	128
Green H	Color picker / Level of green	0-255	128
Blue H	Color picker / Level of blue	0-255	128
Red L	Color picker / Level of red	0-255	128
Green L	Color picker / Level of green	0-255	128
Blue L	Color picker / Level of blue	0-255	128
Left (px)	Left (px)	0-8192	0
Right (px)	Right (px)	0-8192	0
Top (px)	Top (px)	0-8192	0
Bottom (px)	Bottom (px)	0-8192	0

▼ **Color Stripes H Crop Pixel**



Applies the "Color Stripes H" FX within an adjustable rectangular area with hard edges. It adds horizontal color stripes in different sizes.

Parameter	Description	Value Range	Default
Mix	Level of effect itself	0-255	0
Amount	Amount	0-65535	1024
Left (px)	Left (px)	0-8192	0
Right (px)	Right (px)	0-8192	0
Top (px)	Top (px)	0-8192	0
Bottom (px)	Bottom (px)	0-8192	0

▼ **Color Stripes V Crop Pixel**



Applies the "Color Stripes V" FX within an adjustable rectangular area with hard edges. It adds vertical color stripes in different sizes.

Parameter	Description	Value Range	Default
Mix	Level of effect itself	0-255	0
Amount	Amount	0-65535	1024
Left (px)	Left (px)	0-8192	0
Right (px)	Right (px)	0-8192	0
Top (px)	Top (px)	0-8192	0
Bottom (px)	Bottom (px)	0-8192	0

▼ **Color Fade Crop Pixel**



Applies the "Color Fade" FX within an adjustable rectangular area with hard edges. It fades all RGB colors to full RGB or CMY color saturation.

Parameter	Description	Value Range	Default
Mix	Level of effect itself	0-255	0
R/C	R/C	0-255	128

G/M	G/M	0-255	128
B/Y	B/Y	0-255	128
Left (px)	Left (px)	0-8192	0
Right (px)	Right (px)	0-8192	0
Top (px)	Top (px)	0-8192	0
Bottom (px)	Bottom (px)	0-8192	0

▼ **ColorScroll Add Crop Pixel**



Applies the "ColorScroll Add" FX within an adjustable rectangular area with hard edges. It applies a color-changing effect to the layer texture by adding the RGB values.

Parameter	Description	Value Range	Default
Mix	Level of effect itself	0-255	0
Scroll Speed	Scroll Speed	0-65535	0
Bottom (px)	Bottom (px)	0-8192	0

▼ **ColorScroll Multiply Crop Pixel**

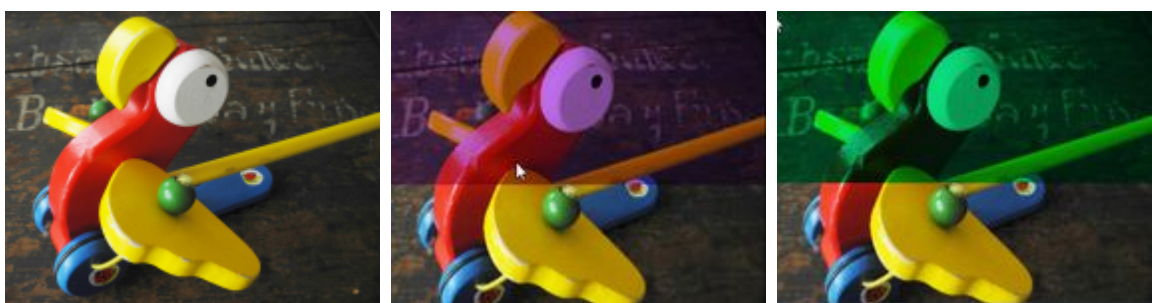

Applies the "ColorScroll Multiply" FX within an adjustable rectangular area with hard edges. It applies a color-changing effect to the layer texture by multiplying the RGB values.

Parameter	Description	Value Range	Default
Mix	Level of effect itself	0-255	0
Scroll Speed	Scroll Speed	0-65535	0
Left (px)	Left (px)	0-8192	0
Right (px)	Right (px)	0-8192	0
Top (px)	Top (px)	0-8192	0
Bottom (px)	Bottom (px)	0-8192	0

▼ **ColorScroll Only Crop Pixel**



Applies the "ColorScroll Only" FX within an adjustable rectangular area with hard edges. It applies a color-changing effect to the layer texture by overlaying the original RGB values.

Parameter	Description	Value Range	Default
Mix	Level of effect itself	0-255	0
Scroll Speed	Scroll Speed	0-65535	0
Left (px)	Left (px)	0-8192	0
Right (px)	Right (px)	0-8192	0
Top (px)	Top (px)	0-8192	0
Bottom (px)	Bottom (px)	0-8192	0

▼ **Emboss Angle Crop Pixel**



Applies an emboss effect with different angles in an adjustable rectangular area with hard edges.

Parameter	Description	Value Range	Default
Mix	Level of effect itself	0-255	0
Factor	Factor	0-255	128
Orientation	Orientation	0-255	128
Left (px)	Left (px)	0-8192	0
Right (px)	Right (px)	0-8192	0
Top (px)	Top (px)	0-8192	0
Bottom (px)	Bottom (px)	0-8192	0

▼ **Emboss Crop Pixel**



Applies an emboss effect in an adjustable rectangular area with hard edges.

Parameter	Description	Value Range	Default
Mix	Level of effect itself	0-255	0
Threshold	Threshold	0-255	144
Factor	Factor	0-255	196
Left (px)	Left (px)	0-8192	0
Right (px)	Right (px)	0-8192	0
Top (px)	Top (px)	0-8192	0
Bottom (px)	Bottom (px)	0-8192	0

▼ **Emboss Edges Crop Pixel**



Applies an emboss effect with a threshold in an adjustable rectangular area with hard edges.

Parameter	Description	Value Range	Default
Mix	Level of effect itself	0-255	0
Threshold	Threshold	0-255	128
Left (px)	Left (px)	0-8192	0
Right (px)	Right (px)	0-8192	0
Top (px)	Top (px)	0-8192	0
Bottom (px)	Bottom (px)	0-8192	0

▼ Granite Crop Pixel



Applies the "Granite" FX within an adjustable rectangular area with hard edges.

Parameter	Description	Value Range	Default
Mix	Level of effect itself	0-255	0
Amount	Amount	0-255	255
Left (px)	Left (px)	0-8192	0
Right (px)	Right (px)	0-8192	0
Top (px)	Top (px)	0-8192	0
Bottom (px)	Bottom (px)	0-8192	0

▼ Invert Crop Pixel



Applies the "Invert" FX within an adjustable rectangular area with hard edges. It inverts the RGB levels.

Parameter	Description	Value Range	Default
Mix	Level of effect itself	0-255	0
Left (px)	Left (px)	0-8192	0
Right (px)	Right (px)	0-8192	0
Top (px)	Top (px)	0-8192	0
Bottom (px)	Bottom (px)	0-8192	0

▼ **Linear Light Crop Pixel**



Applies the "Linear Light" FX within an adjustable rectangular area with hard edges.

Parameter	Description	Value Range	Default
Mix	Level of effect itself	0-255	0
Left (px)	Left (px)	0-8192	0
Right (px)	Right (px)	0-8192	0
Top (px)	Top (px)	0-8192	0
Bottom (px)	Bottom (px)	0-8192	0

▼ **RGB Inversion Crop Pixel**



Applies the "RGB Inversion" FX within an adjustable rectangular area with hard edges. It inverts the RGB levels with the possibility of setting RGB levels, Threshold and Radius.

Parameter	Description	Value Range	Default
Mix	Level of effect itself	0-255	0
Red	Color picker / Level of red	0-255	128
Green	Color picker / Level of green	0-255	128
Blue	Color picker / Level of blue	0-255	128
Threshold	Threshold	0-255	255
Radius	Radius	0-255	128
Invert	Inverts the RGB levels or the effect	0-255	0
Left (px)	Left (px)	0-8192	0
Right (px)	Right (px)	0-8192	0
Top (px)	Top (px)	0-8192	0
Bottom (px)	Bottom (px)	0-8192	0



▼ **Sepiatone Crop Pixel**



Applies the "Sepiatone" FX within an adjustable rectangular area with hard edges. It tints the texture in sepia tones, amount is adjustable.

Parameter	Description	Value Range	Default
Mix	Level of effect itself	0-255	0
Amount	Amount	0-255	128
Left (px)	Left (px)	0-8192	0
Right (px)	Right (px)	0-8192	0
Top (px)	Top (px)	0-8192	0
Bottom (px)	Bottom (px)	0-8192	0

▼ **Solarize Crop Pixel**



Applies the "Solarize" FX within an adjustable rectangular area with hard edges. It inverts first dark then brighter colors.

Parameter	Description	Value Range	Default
Mix	Level of effect itself	0-255	0
Amount	Amount	0-255	128
Left (px)	Left (px)	0-8192	0
Right (px)	Right (px)	0-8192	0
Top (px)	Top (px)	0-8192	0
Bottom (px)	Bottom (px)	0-8192	0

▼ **Tone Mapping Crop Pixel**



Applies the "Tone Mapping" FX within an adjustable rectangular area with hard edges. It allows to set Fog, Exposure, Gamma, Vignette and Blueshift to create a specific photo style.

Parameter	Description	Value Range	Default
Mix	Level of effect itself	0-255	0
Defog	Defog	0-255	2
Fog Red	Fog Red	0-255	255
Fog Green	Fog Green	0-255	255
Fog Blue	Fog Blue	0-255	255
Exposure	Exposure	0-255	144
Gamma	Gamma	0-255	32
VignetteCenter X	VignetteCenterX	0-65535	32768
VignetteCenter Y	VignetteCenterY	0-65535	32768
VignetteRadius	VignetteRadius	0-65535	65535
VignetteAmount	VignetteAmount	0-255	0
BlueShift	BlueShift	0-255	64
Left (px)	Left (px)	0-8192	0
Right (px)	Right (px)	0-8192	0
Top (px)	Top (px)	0-8192	0
Bottom (px)	Bottom (px)	0-8192	0

▼ **TriTone Crop Pixel**



Applies the "TriTone" FX within an adjustable rectangular area with hard edges. It colorizes the image based upon its luminance values in a mix of three colors, each for high (H), middle (M) and low (L) levels, using color pickers.

Parameter	Description	Value Range	Default
Mix	Level of effect itself	0-255	0
Red H	Color picker / Level of red	0-255	128
Green H	Color picker / Level of green	0-255	128
Blue H	Color picker / Level of blue	0-255	128
Red M	Red M	0-255	128
Green M	Green M	0-255	128
Blue M	Blue M	0-255	128
Red L	Color picker / Level of red	0-255	128
Green L	Color picker / Level of green	0-255	128
Blue L	Color picker / Level of blue	0-255	128
Left (px)	Left (px)	0-8192	0
Right (px)	Right (px)	0-8192	0
Top (px)	Top (px)	0-8192	0
Bottom (px)	Bottom (px)	0-8192	0

### 5.4.2.11.13 COLOR EFFECTS - SOFTBORDER

▼ **B&W Add Softborder**



Applies the "B&W Add" FX within an adjustable rectangular area with soft edges. It adds Black and White values to the RGB colors, the result can be inverted. Uses the color picker, with saturation set to 0 by default.

Parameter	Description	Value Range	Default
Mix	Level of effect itself	0-255	0
Red	Color picker / Level of red	0-255	128
Green	Color picker / Level of green	0-255	128
Blue	Color picker / Level of blue	0-255	128
Invert	Inverts the RGB levels or the effect	0-255	0
Size	Size	0-255	16
Corner	Corner	0-255	0

▼ **B&W Multiply Softborder**



Applies the "B&W Multiply" FX within an adjustable rectangular area with soft edges. All RGB colors are multiplied by B&W color mix value, the result can be inverted.

Uses the color picker, with saturation set to 0 by default.

Parameter	Description	Value Range	Default
Mix	Level of effect itself	0-255	0
Red	Color picker / Level of red	0-255	128
Green	Color picker / Level of green	0-255	128
Blue	Color picker / Level of blue	0-255	128
Factor	Factor	0-255	64
Invert	Inverts the RGB levels or the effect	0-255	0
Size	Size	0-255	16
Corner	Corner	0-255	0

▼ **B&W Softborder**



Applies the "B&W" FX within an adjustable rectangular area with soft edges. It turns the RGB image into Black and White, the result can be inverted.

Parameter	Description	Value Range	Default
Mix	Level of effect itself	0-255	0
Invert	Inverts the RGB levels or the effect	0-255	0
Size	Size	0-255	16
Corner	Corner	0-255	0

▼ **BiTone Softborder**



Applies the "Bitone" FX within an adjustable rectangular area with soft edges. It turns the RGB image into just two colors, using Threshold. Both colors can be set by color pickers.

Parameter	Description	Value Range	Default
Mix	Level of effect itself	0-255	0
Red 1	First color picker / Level of red	0-255	255
Green 1	First color picker / Level of green	0-255	255
Blue 1	First color picker / Level of blue	0-255	255
Red 2	Second color picker / Level of red	0-255	0
Green 2	Second color picker / Level of green	0-255	0
Blue 2	Second color picker / Level of blue	0-255	0
Threshold	Threshold	0-255	128
Size	Size	0-255	16
Corner	Corner	0-255	0

▼ **BiTone Luma Softborder**



Applies the "BiTone Luma" FX within an adjustable rectangular area with soft edges. It colorizes the image based upon its luminance values in two colors, each for high (H) and low (L) levels, using color pickers.

Parameter	Description	Value Range	Default
Mix	Level of effect itself	0-255	0
Red H	Color picker / Level of red	0-255	128
Green H	Color picker / Level of green	0-255	128
Blue H	Color picker / Level of blue	0-255	128
Red L	Color picker / Level of red	0-255	128
Green L	Color picker / Level of green	0-255	128
Blue L	Color picker / Level of blue	0-255	128
Size	Size	0-255	16

Corner	Corner	0-255	0
--------	--------	-------	---

▼ **Color Stripes H Softborder**



Applies the "Color Stripes H" FX within an adjustable rectangular area with soft edges. It adds horizontal color stripes in different sizes.

Parameter	Description	Value Range	Default
Mix	Level of effect itself	0-255	0
Amount	Amount	0-65535	1024
Size	Size	0-255	16
Corner	Corner	0-255	0

▼ **Color Stripes V Softborder**



Applies the "Color Stripes V" FX within an adjustable rectangular area with soft edges. It adds vertical color stripes in different sizes.

Parameter	Description	Value Range	Default
Mix	Level of effect itself	0-255	0
Amount	Amount	0-65535	1024
Size	Size	0-255	16
Corner	Corner	0-255	0

▼ **Color Fade Softborder**



Applies the "Color Fade" FX within an adjustable rectangular area with soft edges. It fades all RGB colors to full RGB or CMY color saturation.

Parameter	Description	Value Range	Default
Mix	Level of effect itself	0-255	0
R/C	R/C	0-255	128
G/M	G/M	0-255	128
B/Y	B/Y	0-255	128
Size	Size	0-255	16
Corner	Corner	0-255	0

▼ **ColorScroll Add Softborder**



Applies the "ColorScroll Add" FX within an adjustable rectangular area with soft edges. It applies a color-changing effect to the layer texture by adding the RGB values.

Parameter	Description	Value Range	Default
Mix	Level of effect itself	0-255	0
Scroll Speed	Scroll Speed	0-65535	0
Corner	Corner	0-255	0

▼ **ColorScroll Multiply Softborder**



Applies the "ColorScroll Multiply" FX within an adjustable rectangular area with soft edges. It applies a color-changing effect to the layer texture by multiplying the RGB values.

Parameter	Description	Value Range	Default
Mix	Level of effect itself	0-255	0
Scroll Speed	Scroll Speed	0-65535	0
Corner	Corner	0-255	0

▼ **ColorScroll Only Softborder**



Applies the "ColorScroll Only" FX within an adjustable rectangular area with soft edges. It applies a color-changing effect to the layer texture by overlaying the original RGB values.

Parameter	Description	Value Range	Default
Mix	Level of effect itself	0-255	0
Scroll Speed	Scroll Speed	0-65535	0
Corner	Corner	0-255	0

▼ **Emboss Angle Softborder**



Applies an emboss effect with different angles in an adjustable rectangular area with soft edges.



Parameter	Description	Value Range	Default
Mix	Level of effect itself	0-255	0
Factor	Factor	0-255	128
Orientation	Orientation	0-255	128
Size	Size	0-255	16
Corner	Corner	0-255	0

▼ **Emboss Edges Softborder**



Applies an emboss effect with a threshold in an adjustable rectangular area with soft edges.

Parameter	Description	Value Range	Default
Mix	Level of effect itself	0-255	0
Threshold	Threshold	0-255	128
Size	Size	0-255	16
Corner	Corner	0-255	0

▼ **Emboss Softborder**



Applies an emboss effect in an adjustable rectangular area with soft edges.

Parameter	Description	Value Range	Default
Mix	Level of effect itself	0-255	0
Threshold	Threshold	0-255	144
Factor	Factor	0-255	196
Size	Size	0-255	16
Corner	Corner	0-255	0

▼ **Invert Softborder**



Applies the "Invert" FX within an adjustable rectangular area with soft edges. It inverts the RGB levels.

Parameter	Description	Value Range	Default
Mix	Level of effect itself	0-255	0
Size	Size	0-255	16
Corner	Corner	0-255	0

▼ **Linear Light Softborder**



Applies the "Linear Light" FX within an adjustable rectangular area with soft edges.

Parameter	Description	Value Range	Default
Mix	Level of effect itself	0-255	0
Size	Size	0-255	16
Corner	Corner	0-255	0

▼ **RGB Inversion Softborder**

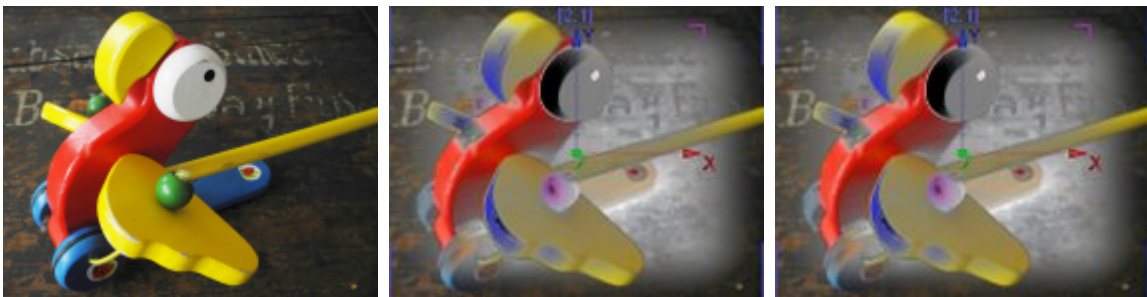

Applies the "RGB Inversion" FX within an adjustable rectangular area with soft edges. It inverts the RGB levels with the possibility of setting RGB levels, Threshold and Radius.

Parameter	Description	Value Range	Default
-----------	-------------	-------------	---------

Mix	Level of effect itself	0-255	0
Red	Color picker / Level of red	0-255	128
Green	Color picker / Level of green	0-255	128
Blue	Color picker / Level of blue	0-255	128
Threshold	Threshold	0-255	255
Radius	Radius	0-255	128
Invert	Inverts the RGB levels or the effect	0-255	0
Size	Size	0-255	16
Corner	Corner	0-255	0

▼ **Sepiatone Softborder**



Applies the "Sepiatone" FX within an adjustable rectangular area with soft edges. It tints the texture in sepia tones, amount is adjustable.

Parameter	Description	Value Range	Default
Mix	Level of effect itself	0-255	0
Amount	Amount	0-255	128
Size	Size	0-255	16
Corner	Corner	0-255	0

▼ **Tone Mapping Softborder**



Applies the "Tone Mapping" FX within an adjustable rectangular area with soft edges. It allows to set Fog, Exposure, Gamma, Vignette and Blueshift to create a specific photo style.

Parameter	Description	Value Range	Default
Mix	Level of effect itself	0-255	0
Defog	Defog	0-255	2
Fog Red	Fog Red	0-255	255
Fog Green	Fog Green	0-255	255
Fog Blue	Fog Blue	0-255	255

Exposure	Exposure	0-255	144
Gamma	Gamma	0-255	32
VignetteCenterX	VignetteCenterX	0-65535	32768
VignetteCenterY	VignetteCenterY	0-65535	32768
VignetteRadius	VignetteRadius	0-65535	65535
VignetteAmount	VignetteAmount	0-255	0
BlueShift	BlueShift	0-255	64
Size	Size	0-255	16
Corner	Corner	0-255	0

▼ **TriTone Softborder**



Applies the "TriTone" FX within an adjustable rectangular area with soft edges. It colorizes the image based upon its luminance values in a mix of three colors, each for high (H), middle (M) and low (L) levels, using color pickers.

Parameter	Description	Value Range	Default
Mix	Level of effect itself	0-255	0
Red H	Color picker / Level of red	0-255	128
Green H	Color picker / Level of green	0-255	128
Blue H	Color picker / Level of blue	0-255	128
Red M	Red M	0-255	128
Green M	Green M	0-255	128
Blue M	Blue M	0-255	128
Red L	Color picker / Level of red	0-255	128
Green L	Color picker / Level of green	0-255	128
Blue L	Color picker / Level of blue	0-255	128
Size	Size	0-255	16
Corner	Corner	0-255	0

### 5.4.2.11.14 COLOR SHIFT

#### ▼ BW Media ColorShift Scroll

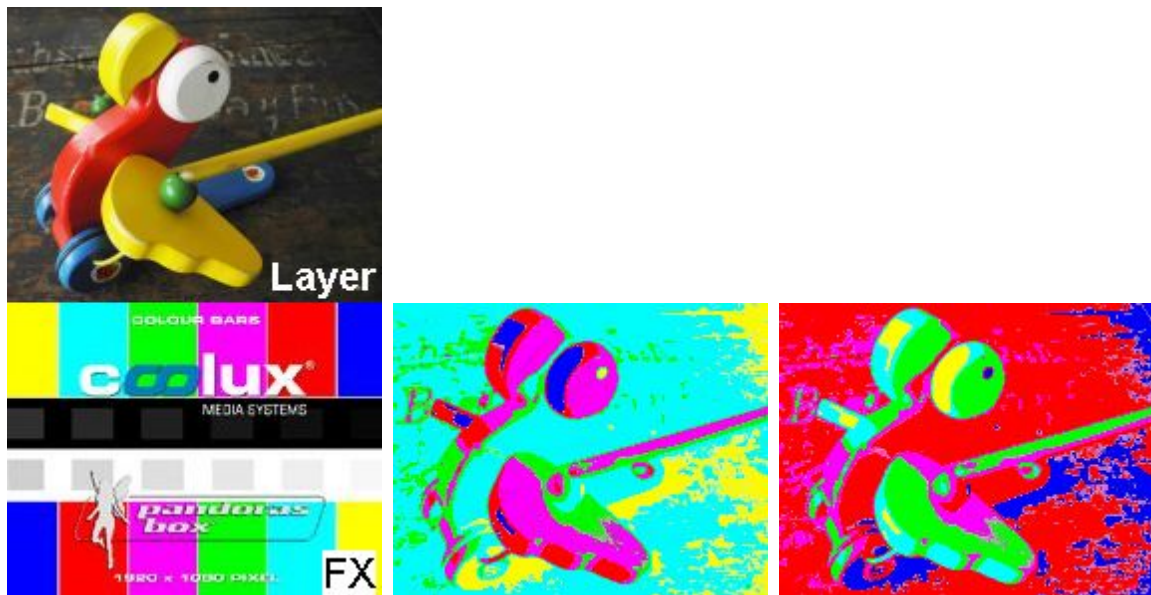

This effect mixes the layer texture with color values of (one horizontal line of) the effect media. The overlaid color is taken from the very left position for black values and moves further to the right the brighter the original pixel is. In the middle image the "Line" parameter is set to "0", so only the colors from the top line are taken. Dark original pixels are now yellow or cyan, the most brightest ones are red or even blue. For the last image the "Line" parameter is set to "255", so the bottom line from the FX media is applied.

With the "Scroll" parameter the overlaid line scrolls with the according speed from top to bottom; press "Reset" to match "0" to the top line again.

Parameter	Description	Value Range	Default
Mix	Level of effect itself	0-255	0
Line	Line	0-255	0
Scroll	Scroll	0-65535	0
Media	Media file as source for overlay or mask	-	-

▼ **BW Media ColorShift**

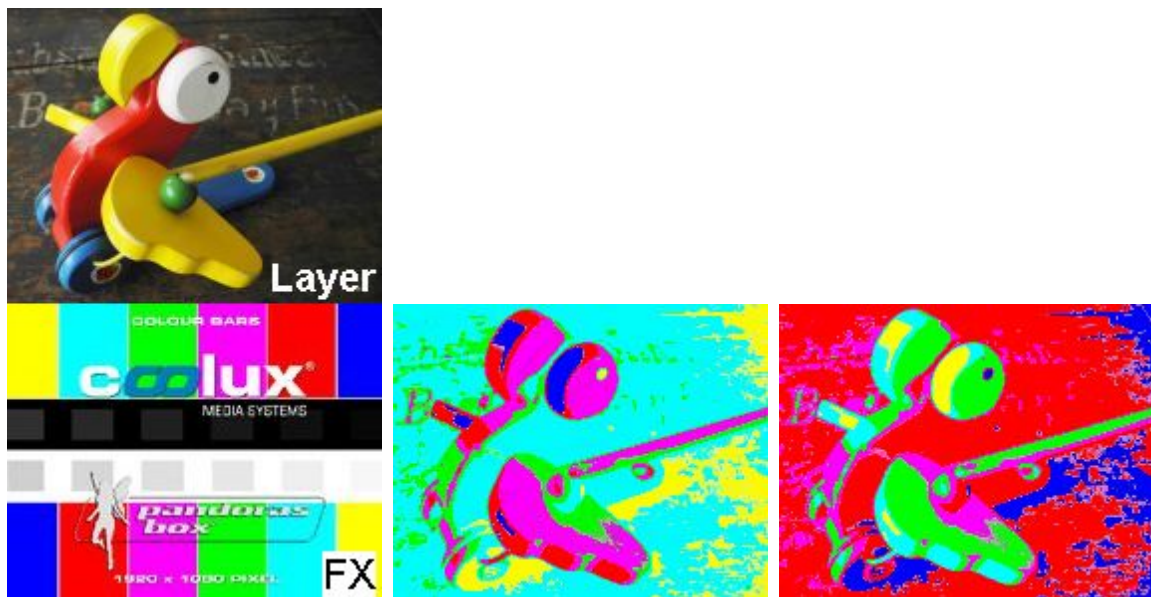

This effect mixes the layer texture with color values of (one horizontal line of) the effect media. The overlaid color is taken from the very left position for black values and moves further to the right the brighter the original pixel is. In the middle image the "Line" parameter is set to "0", so only the colors from the top line are taken. Dark original pixels are now yellow or cyan, the most brightest ones are red or even blue. For the last image the "Line" parameter is set to "255", so the bottom line from the FX media is applied.

Parameter	Description	Value Range	Default
Mix	Level of effect itself	0-255	0
Line	Line	0-255	0
Media	Media file as source for overlay or mask	-	-

▼ **Color Inversion**



Inverts the image based upon its RGB values and allows to influence the color, threshold and feather.

Parameter	Description	Value Range	Default
Mix	Level of Effect	0-255	0
Red	Red level, Color Picker	0-255	128
Green	Green level, Color Picker	0-255	128
Blue	Blue level, Color Picker	0-255	128
Threshold	Threshold	0-255	255

Feather	Feather	0-255	128
---------	---------	-------	-----

▼ **ColorOnly**



Turns the image into a single color and allows to set an alpha value to define the transparency of the layer.

Parameter	Description	Value Range	Default
Mix	Level of Effect	0-255	0
Red	Red level, Color Picker	0-255	128
Green	Green level, Color Picker	0-255	128
Blue	Blue level, Color Picker	0-255	128
Alpha	Set the transparency of the layer.	0-255	128

▼ **RGB Add**



Adds RGB colors by the RGB color mix value, allows inverting the image.

Parameter	Description	Value Range	Default
Mix	Level of Effect	0-255	0
Red	Red level, Color Picker	0-255	128
Green	Green level, Color Picker	0-255	128
Blue	Blue level, Color Picker	0-255	128
Invert	Inverts the RGB Levels	0-255	0

▼ **RGB Channel Inversion**

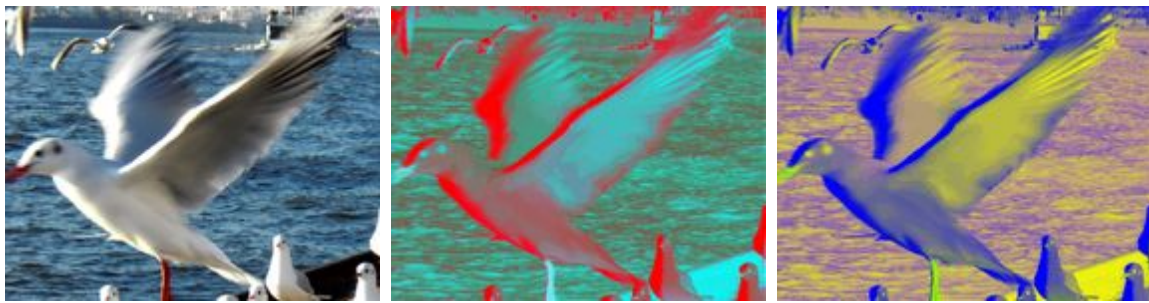

Allows to invert the image channel by channel (RGB & alpha)

Parameter	Description	Value Range	Default
Mix	Level of Effect	0-255	0
R	Red level inversion	0-255	0
G	Green level inversion	0-255	0
B	Blue level inversion	0-255	0
A	Alpha level inversion	0-255	0

▼ **RGB Hue**



Changes all color values of the layer texture to the chosen hue / color. Black and white pixels are not influenced.

Parameter	Description	Value Range	Default
Mix	Level of effect itself	0-255	0
Red	Color picker / Level of red	0-255	0
Green	Color picker / Level of green	0-255	0
Blue	Color picker / Level of blue	0-255	0



▼ **RGB INV Add**



Allows adding RGB colors by the color mix values after inverting the image.

Parameter	Description	Value Range	Default
Mix	Level of Effect	0-255	0
Red	Red level, Color Picker	0-255	0
Green	Green level, Color Picker	0-255	0
Blue	Blue level, Color Picker	0-255	0

▼ **RGB INV Multiply**



Allows multiplying with RGB colors by the color mix values after inverting the image.

Parameter	Description	Value Range	Default
Mix	Level of Effect	0-255	0
Red	Red level, Color Picker	0-255	255
Green	Green level, Color Picker	0-255	255
Blue	Blue level, Color Picker	0-255	255

▼ **RGB Multiply**



All RGB colors are multiplied by RGB color mix values. Multiply can be factorized and inverted.

Parameter	Description	Value Range	Default
Mix	Level of Effect	0-255	0
Red	Red level, Color Picker	0-255	255
Green	Green level, Color Picker	0-255	255
Blue	Blue level, Color Picker	0-255	255
Factor	Color Multiply Factor	0-255	64
Invert	Inverts the RGB levels	0-255	0

▼ **RGB Replace**



With this effect you can pick one color that should be replaced and if needed, fine tune the color range with the "Threshold" and "Radius" parameters. Then pick a new color that replaces it.

Parameter	Description	Value Range	Default
Mix	Level of effect itself	0-255	0
Red Old	Red Old	0-255	0
Green Old	Green Old	0-255	0
Blue Old	Blue Old	0-255	0
Threshold	Threshold	0-255	64
Radius	Radius	0-255	32
Red New	Red New	0-255	0
Green New	Green New	0-255	0
Blue New	Blue New	0-255	0

▼ **RGB Screen**



This applies the screen blend mode, i.e. it negates the RGB values of the layer texture, then multiplying them and negates them again. The result is a brighter image.

Parameter	Description	Value Range	Default
Mix	Level of effect itself	0-255	0

▼ RGB Shift



With this effect you can tint your image with a certain color. In detail, the original RGB color values are increased with the chosen RGB value, as long as their according RGB share is greater than 0.

Parameter	Description	Value Range	Default
Mix	Level of Effect	0-255	0
Red	Red level, Color Picker	0-255	255
Green	Green level, Color Picker	0-255	255
Blue	Blue level, Color Picker	0-255	255

▼ RGB XY Shift



Allows shifting all RGB colors in X and Y direction.

Parameter	Description	Value Range	Default
Mix	Level of Effect	0-255	0
R X	Red level shift in X direction	0-65535	32768
R Y	Red level shift in Y direction	0-65535	32768
G X	Green level shift in X direction	0-65535	32768
G Y	Green level shift in Y direction	0-65535	32768
B X	Blue level shift in X direction	0-65535	32768
B Y	Blue level shift in Y direction	0-65535	32768

▼ RGB-BGR Add



All RGB channels are shifted and added by the color mix value and may be inverted.

Parameter	Description	Value Range	Default
Mix	Level of Effect	0-255	0
Red	Red level, Color Picker	0-255	255
Green	Green level, Color Picker	0-255	255
Blue	Blue level, Color Picker	0-255	255
Invert	Inverts the RBG values	0-255	0

▼ RGB-BGR Multiply



All RGB channels are shifted and multiplied by the color mix value and may be factorized and inverted.

Parameter	Description	Value Range	Default
Mix	Level of Effect	0-255	0
Red	Red level, Color Picker	0-255	255
Green	Green level, Color Picker	0-255	255
Blue	Blue level, Color Picker	0-255	255
Factor	Factor of Multiplication	0-255	64
Invert	Inverts the RBG values	0-255	0

▼ RGB-BRG Add



All RGB channels are shifted and added by the color mix value and may be inverted.

Parameter	Description	Value Range	Default
Mix	Level of Effect	0-255	0
Red	Red level, Color Picker	0-255	255
Green	Green level, Color Picker	0-255	255
Blue	Blue level, Color Picker	0-255	255
Invert	Inverts the RBG values	0-255	0

▼ **RGB-BRG Multiply**



All RGB channels are shifted and multiplied by the color mix value and may be factorized and inverted.

Parameter	Description	Value Range	Default
Mix	Level of Effect	0-255	0
Red	Red level, Color Picker	0-255	255
Green	Green level, Color Picker	0-255	255
Blue	Blue level, Color Picker	0-255	255
Factor	Factor of Multiplication	0-255	64
Invert	Inverts the RBG values	0-255	0

▼ **RGB-GBR Add**



All RGB channels are shifted and added by the color mix value and may be inverted.

Parameter	Description	Value Range	Default
Mix	Level of Effect	0-255	0
Red	Red level, Color Picker	0-255	255
Green	Green level, Color Picker	0-255	255
Blue	Blue level, Color Picker	0-255	255
Invert	Inverts the RBG values	0-255	0

▼ **RGB-GBR Multiply**



All RGB channels are shifted and multiplied by the color mix value and may factorized and inverted.

Parameter	Description	Value Range	Default
Mix	Level of Effect	0-255	0
Red	Red level, Color Picker	0-255	255
Green	Green level, Color Picker	0-255	255
Blue	Blue level, Color Picker	0-255	255
Factor	Factor of Multiplication	0-255	64
Invert	Inverts the RBG values	0-255	0

▼ **RGB-GRB Add**



All RGB channels are shifted and added by the color mix value and may be inverted.

Parameter	Description	Value Range	Default
Mix	Level of Effect	0-255	0
Red	Red level, Color Picker	0-255	255
Green	Green level, Color Picker	0-255	255
Blue	Blue level, Color Picker	0-255	255
Invert	Inverts the RBG values	0-255	0

▼ **RGB-GRB Multiply**



All RGB channels are shifted and multiplied by the color mix value and may be factorized and inverted.

Parameter	Description	Value Range	Default
Mix	Level of Effect	0-255	0
Red	Red level, Color Picker	0-255	255
Green	Green level, Color Picker	0-255	255
Blue	Blue level, Color Picker	0-255	255
Factor	Factor of Multiplication	0-255	64
Invert	Inverts the RBG values	0-255	0

▼ **RGB-RBG Add**



All RGB channels are shifted and added by the color mix value and may be inverted.

Parameter	Description	Value Range	Default
Mix	Level of Effect	0-255	0
Red	Red level, Color Picker	0-255	255
Green	Green level, Color Picker	0-255	255
Blue	Blue level, Color Picker	0-255	255
Invert	Inverts the RBG values	0-255	0



▼ **RGB-RBG Multiply**



All RGB channels are shifted and multiplied by the color mix value and may be factorized and inverted.

Parameter	Description	Value Range	Default
Mix	Level of Effect	0-255	0
Red	Red level, Color Picker	0-255	255
Green	Green level, Color Picker	0-255	255
Blue	Blue level, Color Picker	0-255	255
Factor	Factor of Multiplication	0-255	64
Invert	Inverts the RBG values	0-255	0

▼ **RGBA Modulo**



Modulo on RGB channels.

Parameter	Description	Value Range	Default
Mix	Level of Effect	0-255	0
Red	Red level, Color Picker	0-255	255
Green	Green level, Color Picker	0-255	255
Blue	Blue level, Color Picker	0-255	255
Alpha	Alpha level	0-255	255

### 5.4.2.11.15 COMPOSITING

#### ▼ ++ General information for Compositing Effects ++

The Compositing Effects allow rendering a whole composition onto one layer, this is the so called Renderhistory. This way the composition can e.g. be scaled or positioned somewhere else on the output without the need of scaling or positioning every single layer.

Please note:

Everything in the 3D space that gets behind the layer with the composition effect will be rendered onto this layer. In doing so the composition does not longer exist as 3D composition, but is transferred into a flat 2D texture.

The example below shows how the Compositing Effects works.

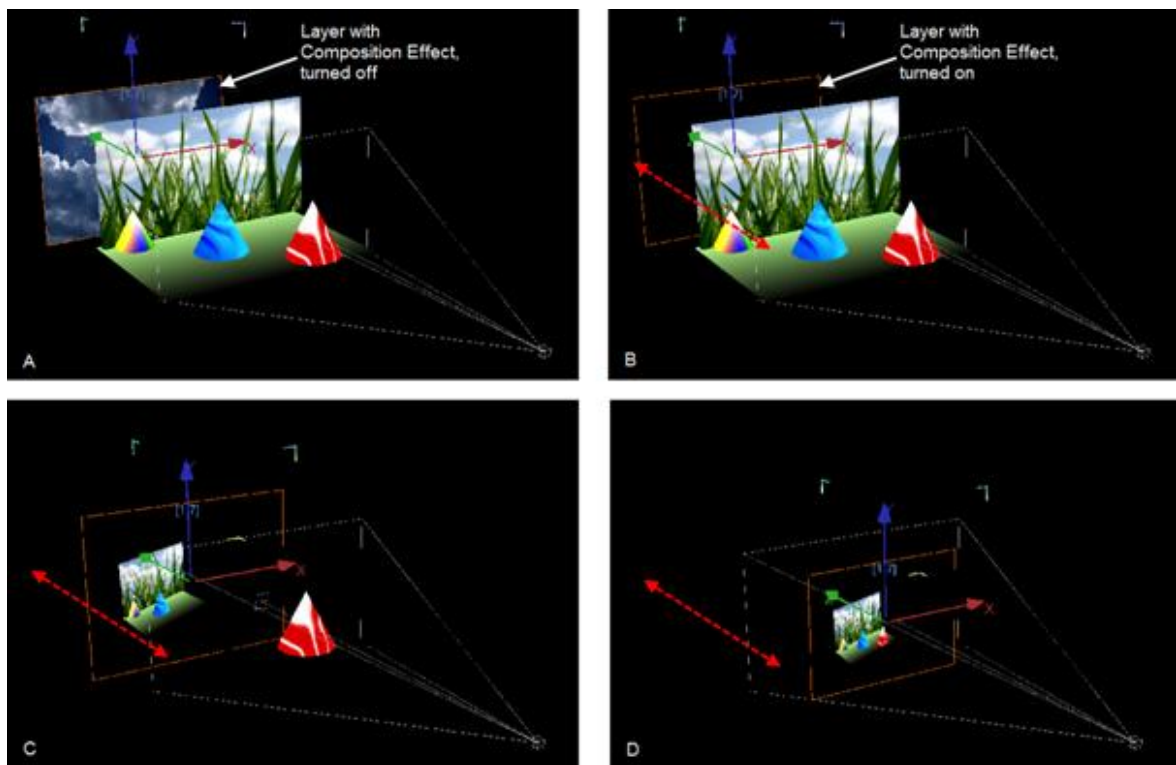

A: There is a layer with grass on it, a bottom layer and three cones. Each item stays in a different Z position. The Compositing Effect will be applied to the layer in the background (with clouds on it).

B: The Compositing Effect is applied to the background layer. The layer now shows black, because there is nothing behind it that could be rendered.

C: The background layer was moved in Z position. It is now in front of the grass, the bottom layer and the first two cones, but behind the red cone. Everything except the red cone is now rendered as texture on the background layer.

D: The background layer is moved further to the front. Every item of the composition is now behind it and will be rendered as its texture.

When looking at the scene above by previewing the Output (and not in Global Cam Mode), you will see this result:

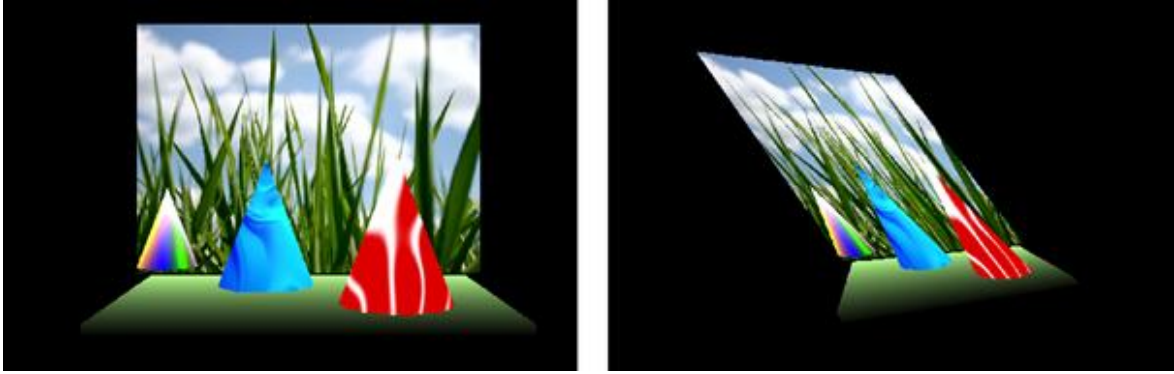

E: When seen from the front side, the composition looks like in the beginning.  
 F: When scaling and rotating the background layer, it is now visible, that the composition is turned from a 3D composition to just a flat texture on the layer, from now on called "Rendering".

The difference between the single Compositing Effects is the way the composition behind the layer is rendered and mixed with the texture being originally on the layer.

The three images for each Compositing Effect show:  
 Left: Effect's Mix Value=0; Center: Effect's Mix Value =128; Right: Effect's Mix Value =255

▼ **Render History**

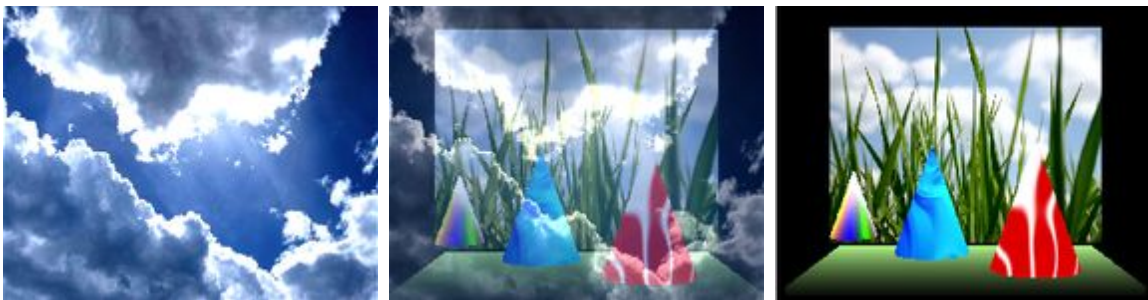

Fades between the Target's texture and the Rendering.

Parameter	Description	Value Range	Default
Mix	Level of Effect	0-255	0

▼ **Target Add**



Adds the pixel values of the Target's texture with the ones of the Rendering. In case of values above 255 (in the case of RGB), white is displayed.

Parameter	Description	Value Range	Default
-----------	-------------	-------------	---------

Mix	Level of Effect	0-255	0
-----	-----------------	-------	---

▼ **Target Buffer**

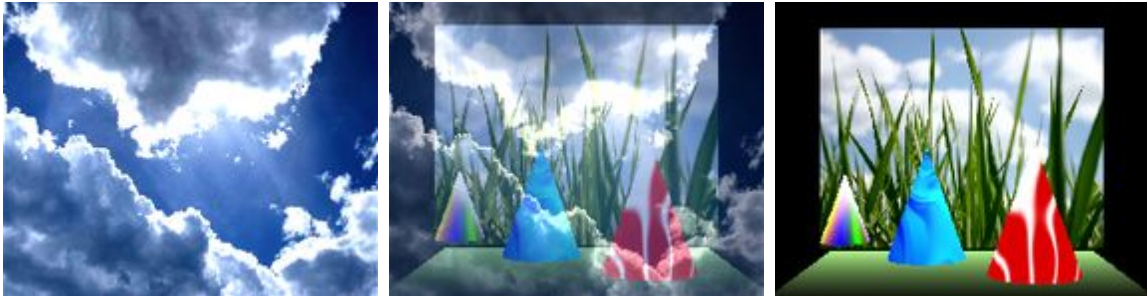

Example above: left: Mix=0; center: Mix=128; right: Mix=255

Parameter	Description	Value Range	Default
Mix	Level of Effect	0-255	0

▼ **Target Color Burn**

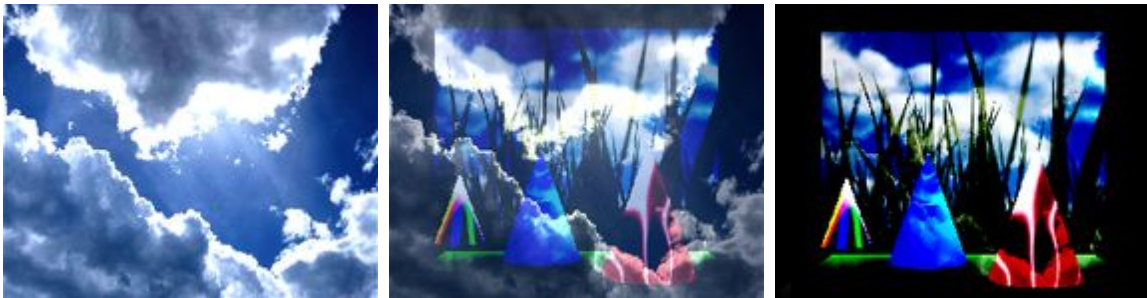

The Color Burn effect divides the inverted Rendering by the Target layer, and then inverts the result. This darkens the Target layer increasing the contrast to reflect the color of the Rendering. The darker the Rendering, the more its color is used. Blending with white produces no difference.

Parameter	Description	Value Range	Default
Mix	Level of Effect	0-255	0

▼ **Target Darken**



Darken takes the darkest value for each pixel from both, the Rendering and the Target layer.

Parameter	Description	Value Range	Default
Mix	Level of Effect	0-255	0

▼ Target Difference



Difference subtracts the Target layer from the Rendering or the other way round; to always get a positive value. Blending with black produces no change, as values for all colors are 0. (The RGB value for black is 0,0,0). Blending with white inverts the picture.

Parameter	Description	Value Range	Default
Mix	Level of Effect	0-255	0

▼ Target Lighten

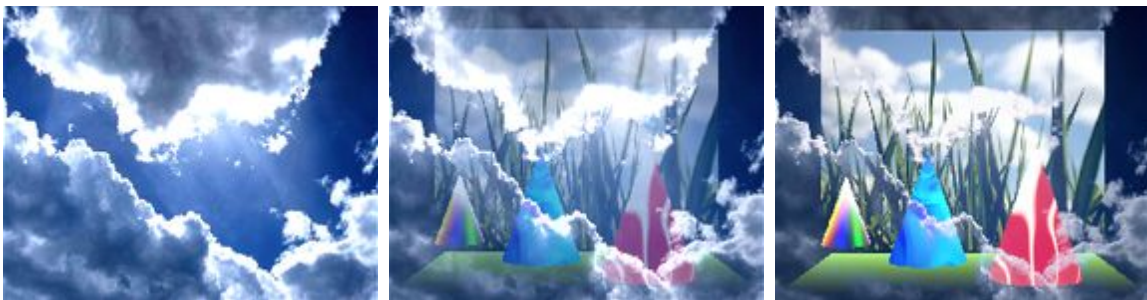

Lighten takes the lightest pixel from both, the Rendering and the Target layer.

Parameter	Description	Value Range	Default
Mix	Level of Effect	0-255	0

▼ Target Multiply



Multiplies each pixel of the Target texture with the Rendering. The result is a darker picture.

Parameter	Description	Value Range	Default
Mix	Level of Effect	0-255	0

▼ Target Reflect

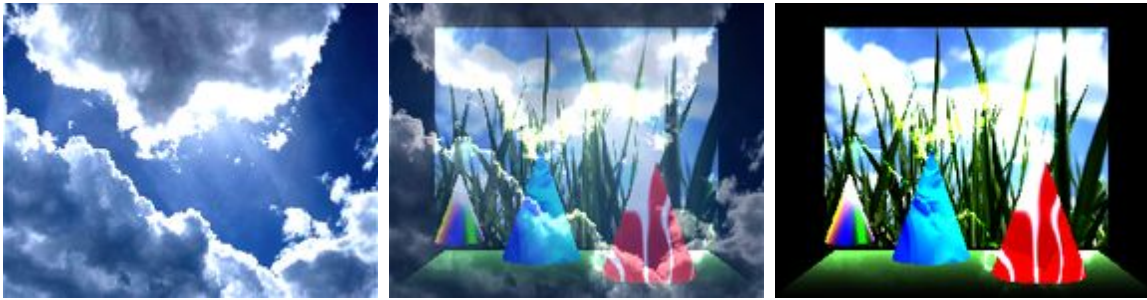

Reflects the Target's texture.

Parameter	Description	Value Range	Default
Mix	Level of Effect	0-255	0

▼ Target Screen

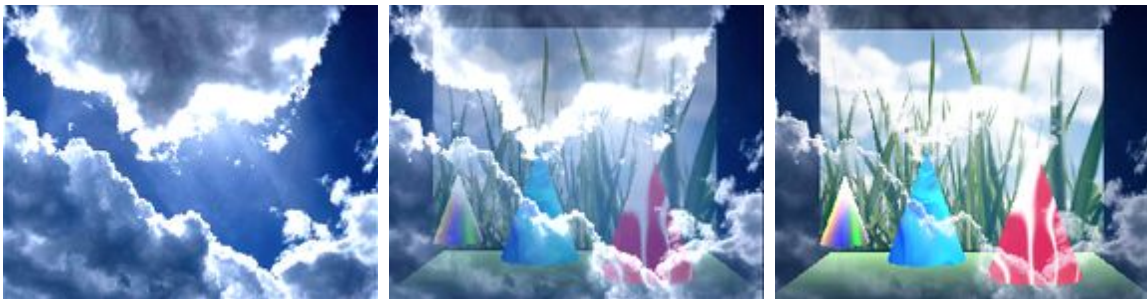

With Target Screen effect the values of the pixels in the two layers (Target and Rendering) are negated, multiplied, and then negated again. This is in some way the opposite of multiply.

The result is a brighter picture.

Parameter	Description	Value Range	Default
Mix	Level of Effect	0-255	0

▼ Target Subtract



This Effect subtracts pixel values of the Target's texture with the Rendering. In case of negative values, black is displayed.

Parameter	Description	Value Range	Default
Mix	Level of Effect	0-255	0

### 5.4.2.11.16 CROPPING

#### ▼ Crop Edges INV Softborder In

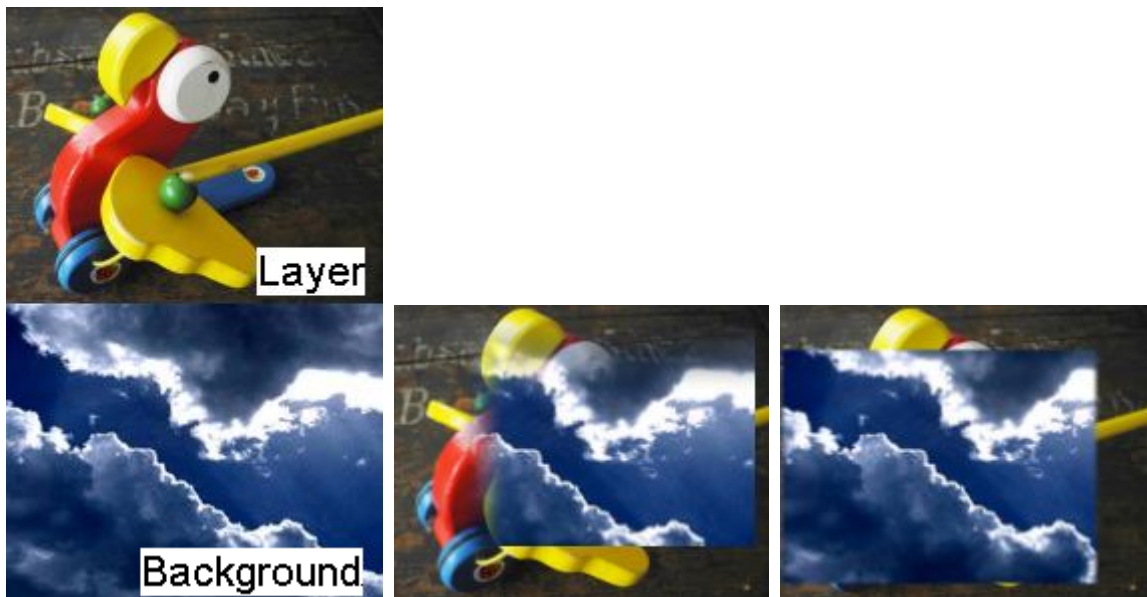

Crops all 4 edges individually into transparency and inverts them. In addition you can set a softborder individually for each side which goes inwards.

Parameter	Description	Value Range	Default
Mix	Level of effect itself	0-255	0
Left	Left	0-65535	0
Right	Right	0-65535	0
Top	Top	0-65535	0
Bottom	Bottom	0-65535	0
Softness	Softness	0-65535	0
Left Soft	Left Soft	0-65535	0
Right Soft	Right Soft	0-65535	0
Top Soft	Top Soft	0-65535	0
Bottom Soft	Bottom Soft	0-65535	0

▼ **Crop Edges INV**

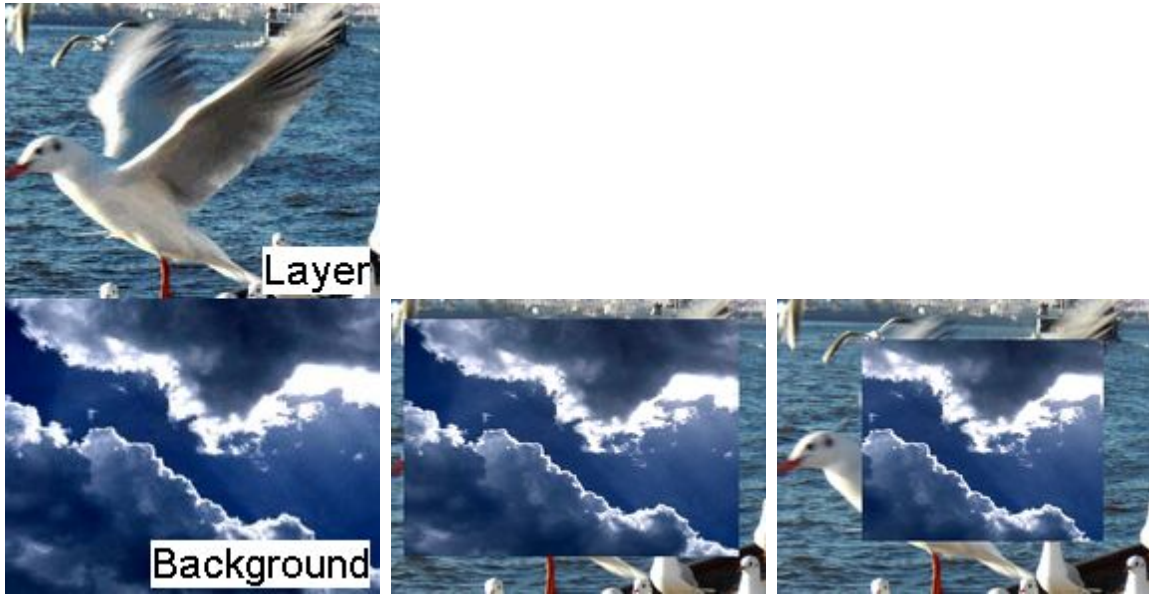

Crops all 4 edges individually into transparency and inverts them.

Parameter	Description	Value Range	Default
Mix	Level of Effect	0-255	0
Left	Crops left edge inverted	0-65535	0
Right	Crops right edge inverted	0-65535	0
Top	Crops top edge inverted	0-65535	0
Bottom	Crops bottom edge inverted	0-65535	0

▼ **Crop Edges Softborder In**

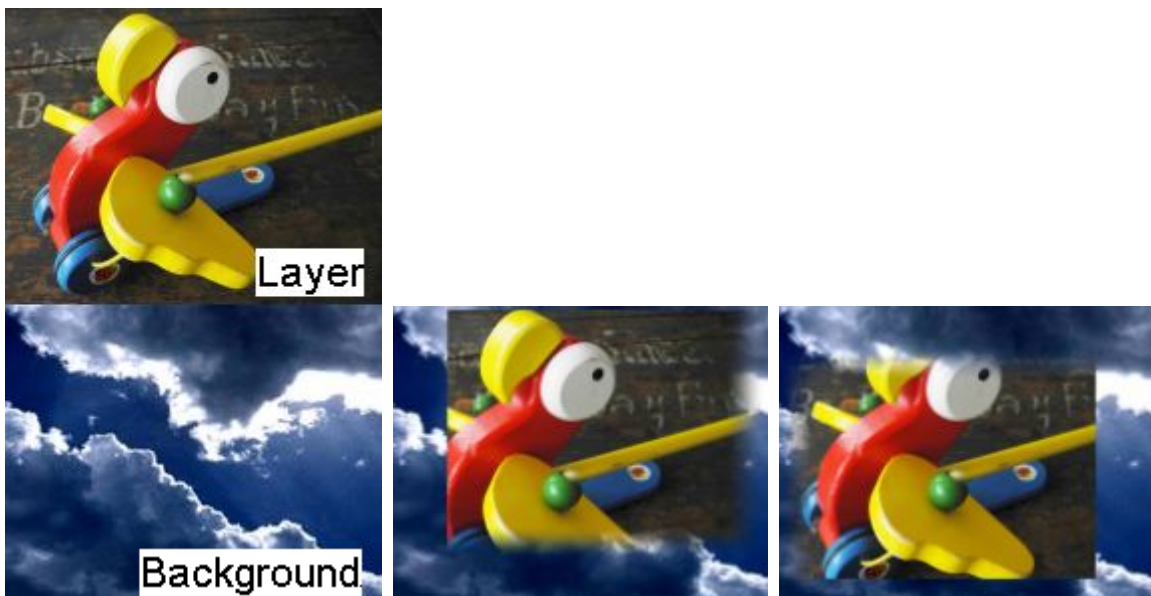

Crops all 4 edges individually into transparency. In addition you can set a softborder individually for each side which goes inwards.



Parameter	Description	Value Range	Default
Mix	Level of effect itself	0-255	0
Left	Left	0-65535	0
Right	Right	0-65535	0
Top	Top	0-65535	0
Bottom	Bottom	0-65535	0
Softness	Softness	0-65535	0
Left Soft	Left Soft	0-65535	0
Right Soft	Right Soft	0-65535	0
Top Soft	Top Soft	0-65535	0
Bottom Soft	Bottom Soft	0-65535	0

▼ **Crop Edges Softborder**



Crops all 4 edges individually into transparency. In addition you can set a softborder individually for each side which goes outwards.

Parameter	Description	Value Range	Default
Mix	Level of effect itself	0-255	0
Left	Left	0-65535	0
Right	Right	0-65535	0
Top	Top	0-65535	0
Bottom	Bottom	0-65535	0
Left Soft	Left Soft	0-65535	0
Right Soft	Right Soft	0-65535	0
Top Soft	Top Soft	0-65535	0
Bottom Soft	Bottom Soft	0-65535	0

▼ Crop Edges

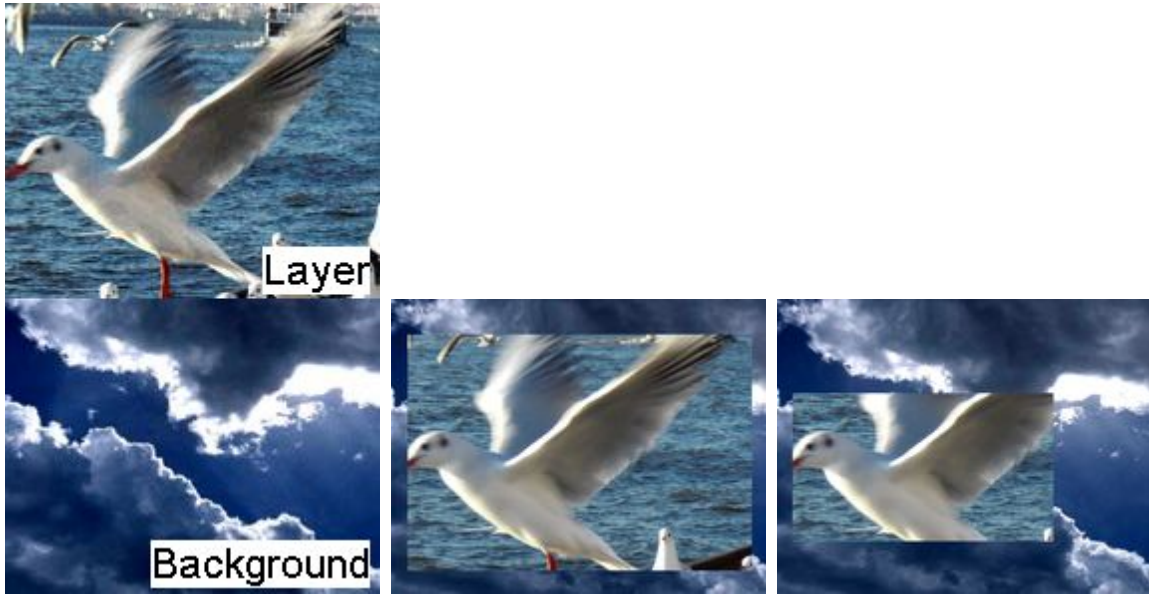

Crops all 4 edges individually into transparency.

Parameter	Description	Value Range	Default
Mix	Level of Effect	0-255	0
Left	Crops left edge	0-65535	0
Right	Crops right edge	0-65535	0
Top	Crops top edge	0-65535	0
Bottom	Crops bottom edge	0-65535	0

▼ Cropper HV RGBA

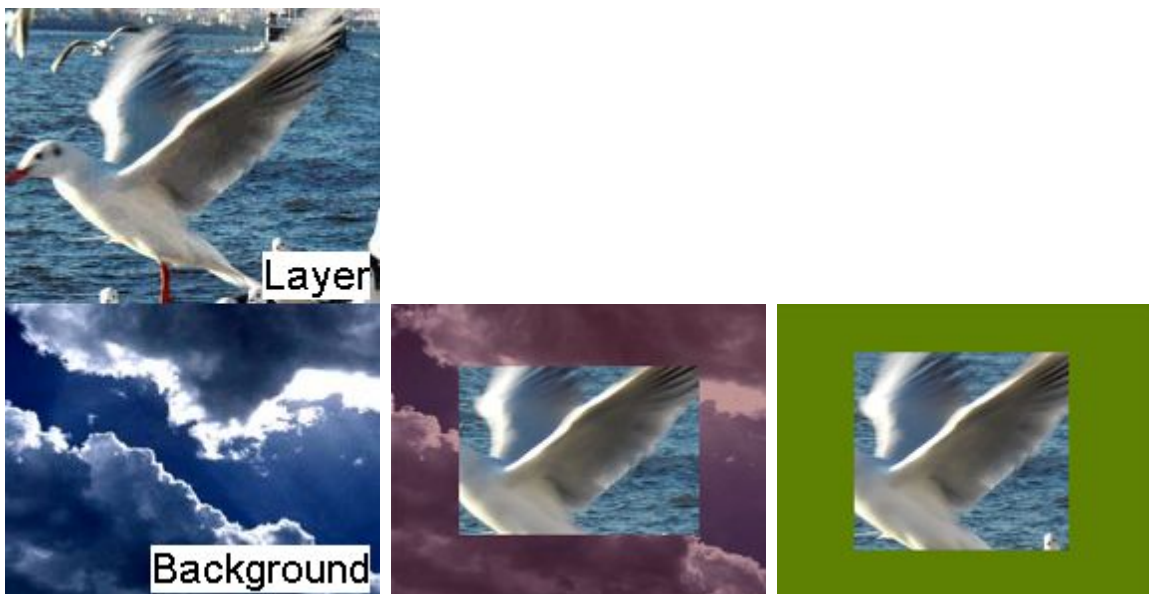

Crops both horizontal edges and independently both vertical edges. The color and transparency of the cropped area can be set with the color and alpha mix parameters.

Parameter	Description	Value Range	Default
Mix	Level of Effect	0-255	0
H	Horizontal even crop	0-65535	0
V	Vertical even crop	0-65535	0
Red	Red level, Color Picker	0-255	128
Green	Green level, Color Picker	0-255	128
Blue	Blue level, Color Picker	0-255	128
Alpha	Alpha level of cropped area	0-255	128

▼ Cropper HV

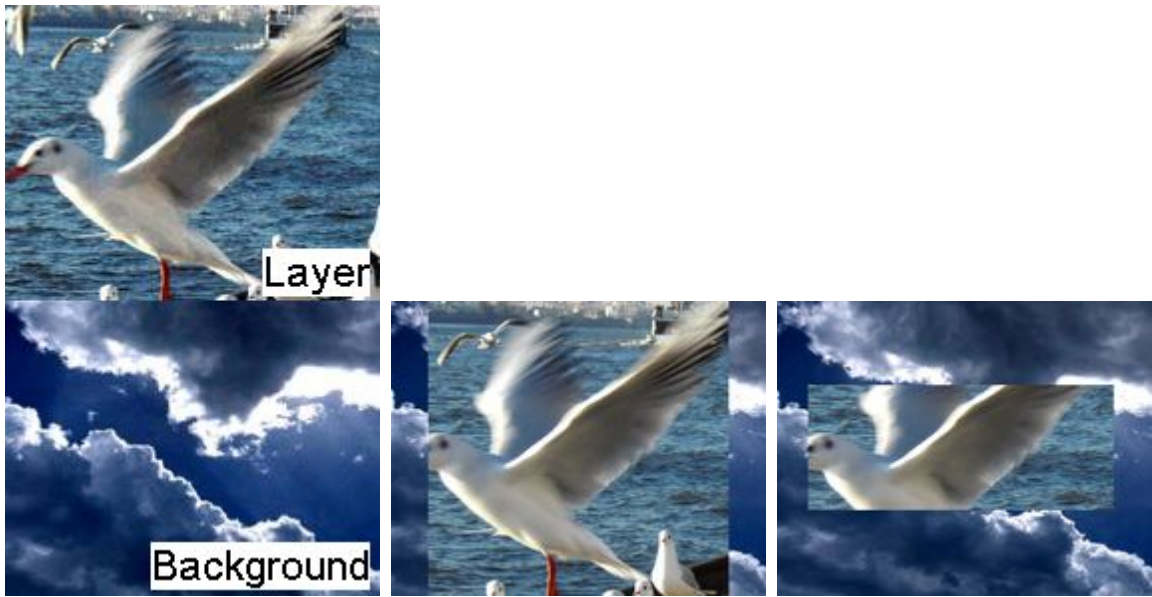

Crops both horizontal edges and independently both vertical edges. The color of the cropped area is transparent.

Parameter	Description	Value Range	Default
Mix	Level of Effect	0-255	0
H	Horizontal even crop	0-65535	0
V	Vertical even crop	0-65535	0

▼ Frame RGBA



Crops all 4 edges equally at the same time creating the impression of framing the layer. The frame size and inwards softborder are adjustable. The color and transparency of the frame can be set with the color and alpha mix parameters.

Parameter	Description	Value Range	Default
Mix	Level of Effect	0-255	0
Size	Size of frame	0-255	8
Feather	Softness of inner frame border	0-255	8
Red	Red level, Color Picker	0-255	128
Green	Green level, Color Picker	0-255	128
Blue	Blue level, Color Picker	0-255	128
Alpha	Alpha level of cropped area	0-255	128

▼ **Frame**

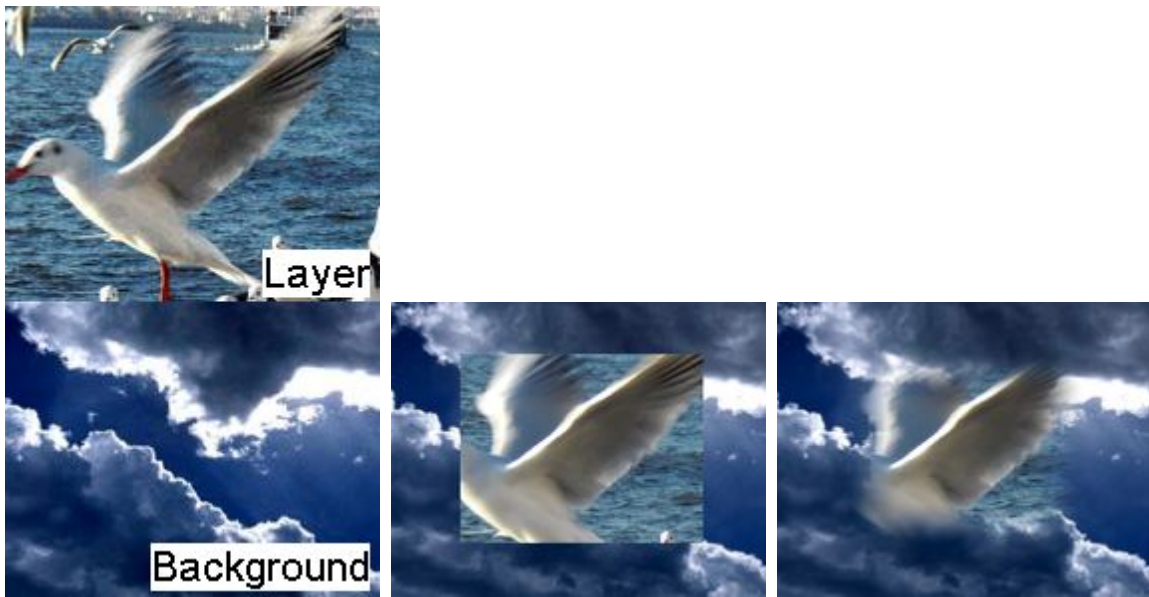

Crops all 4 edges equally at the same time creating the impression of framing the layer. The frame size and inwards softborder are adjustable. The color of the frame is transparent.

Parameter	Description	Value Range	Default
Mix	Level of Effect	0-255	0
Size	Size of frame	0-255	8
Feather	Softness of inner frame border	0-255	8

▼ **Framed Cropper HV**



Crops both horizontal edges and independently both vertical edges. The cropped image can be surrounded with a frame for which you can set up the border width in pixels and the roundness of the corners. The color, transparency and softness of the frame can be set with the color, alpha mix and soft parameters.

Parameter	Description	Value Range	Default
Mix	Level of Effect	0-255	0
Crop H (px)	Horizontal even crop	0-4096	0
Crop V (px)	Vertical even crop	0-4096	0
Frame (px)	Size of frame in pixel	0-4096	0
Red	Red level, Color Picker	0-255	128
Green	Green level, Color Picker	0-255	128
Blue	Blue level, Color Picker	0-255	128
Alpha	Alpha level of cropped area	0-255	128
Soft	Softness of frame	0-255	0
Round	Roundness of frame corners	0-255	0

▼ Iris RGBA



Applies an iris shaped cut-out to the layer creating the impression of putting the layer into a circular frame. The frame size, softborder, position and aspect ratio are adjustable. The color and transparency of the frame can be set with the color and alpha mix parameters. The frame effect can be inverted.

Parameter	Description	Value Range	Default
Mix	Level of Effect	0-255	0
Size	Size of frame	0-255	128
Softness	Softness of iris	0-255	64
U	Position of Iris horizontal	0-65535	32768
V	Position of Iris vertical	0-65535	32768
Aspect	Aspect Ratio of Iris. Default value 128 applies the images aspect ratio to the iris.	0.000 – 128.000	128
Red	Red level, Color Picker	0-255	128
Green	Green level, Color Picker	0-255	128
Blue	Blue level, Color Picker	0-255	128
Alpha	Alpha level of the iris.		
Invert	Invert Iris		

▼ Iris

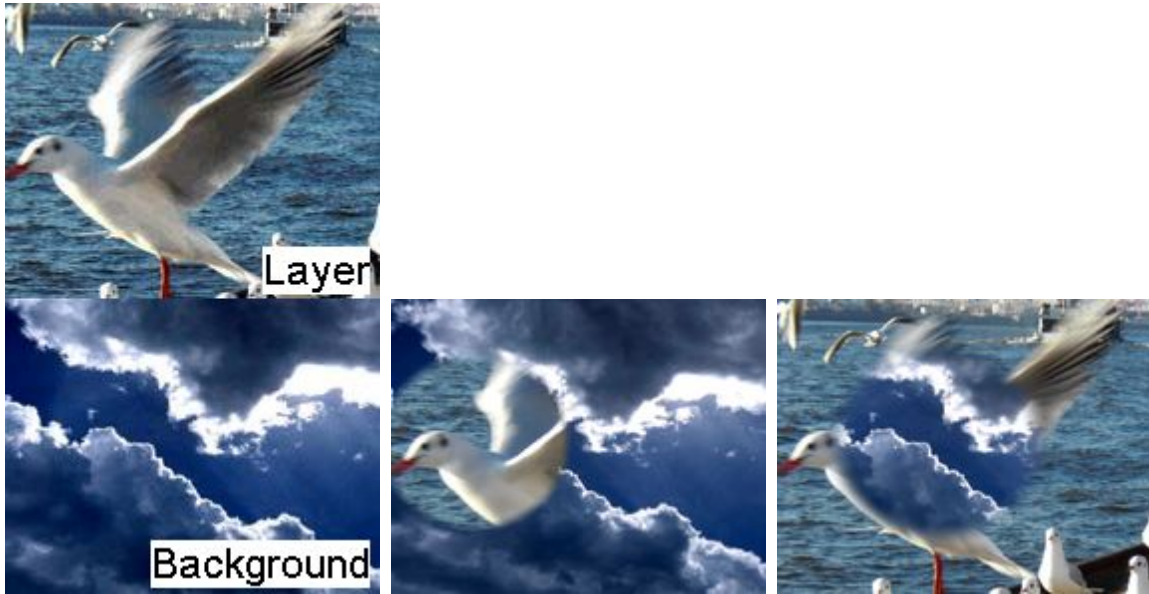

Applies an iris shaped cut-out to the layer creating the impression of putting the layer into a circular frame. The frame size, softborder, position and aspect ratio are adjustable. The frame is transparent and can be inverted.

Parameter	Description	Value Range	Default
Mix	Level of Effect	0-255	0
Size	Size of frame	0-255	128
Softness	Softness of iris	0-255	64
U	Position of Iris horizontal	0-65535	32768
V	Position of Iris vertical	0-65535	32768
Aspect	Aspect Ratio of Iris. Default value 128 applies the images aspect ratio to the iris.	0-255	128
Invert	Invert Iris	0-255	0

▼ Profile Edges Alpha

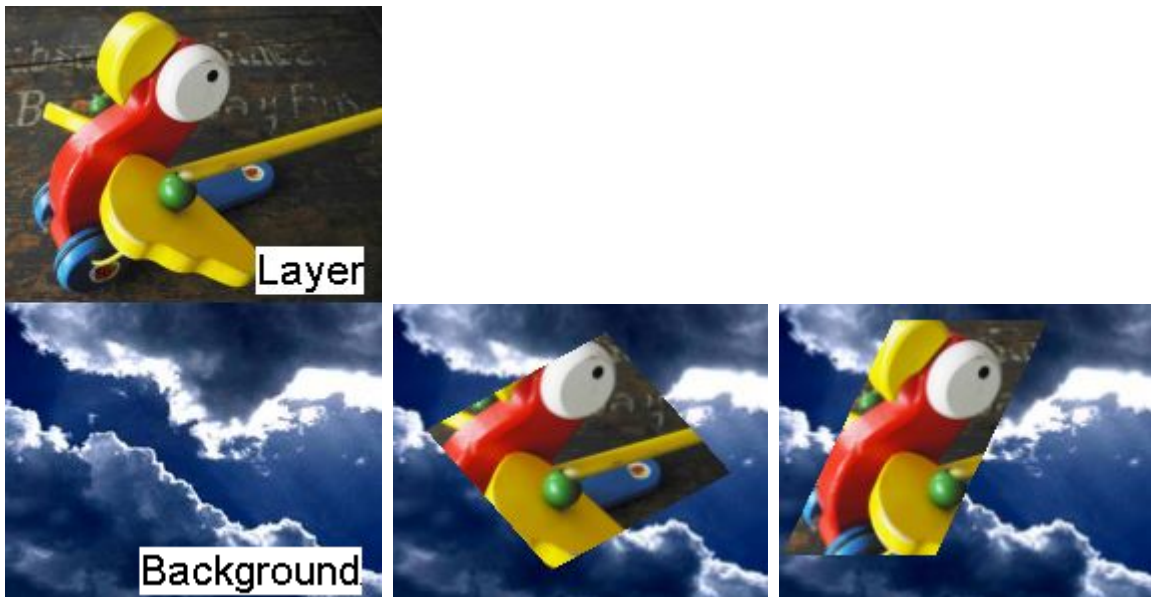

Crops all 4 edges individually into transparency. You can choose for each side how much it should be cropped and rotated.

Parameter	Description	Value Range	Default
Mix	Level of effect itself	0-255	0
Left	Left	0-65535	0
Left R	Left R	0-65535	32768
Right	Right	0-65535	0
Right R	Right R	0-65535	32768
Top	Top	0-65535	0
Top R	Top R	0-65535	32768
Bottom	Bottom	0-65535	0
Bottom R	Bottom R	0-65535	32768



▼ Profile Edges Mask

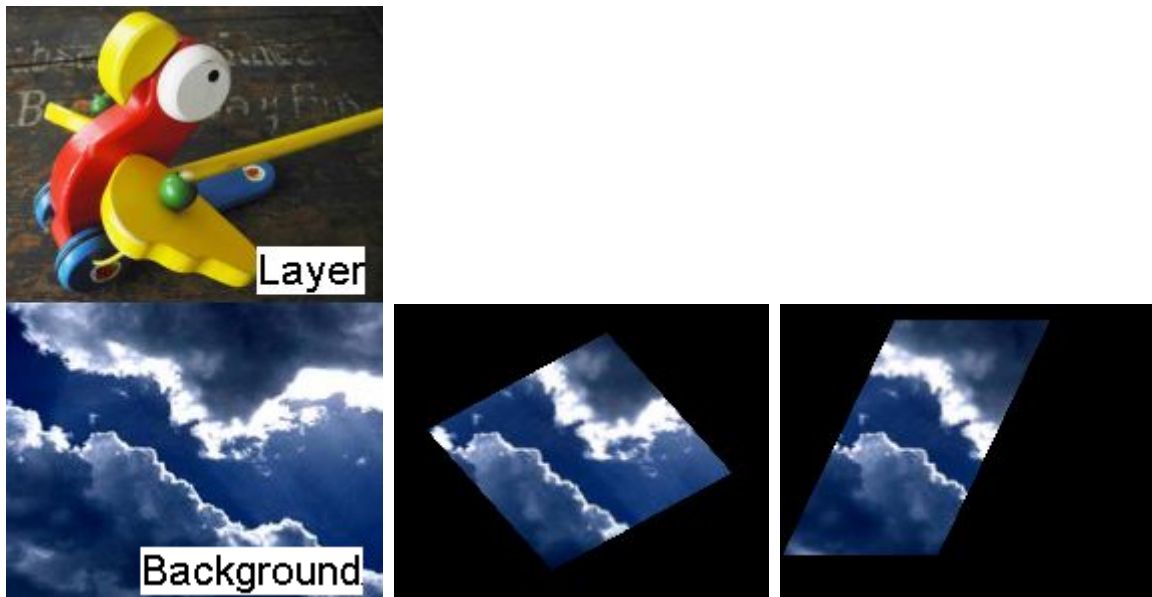

Turns the layer texture into a transparent and black mask. Crops all 4 edges individually into black. You can choose for each side how much it should be cropped and rotated.

Parameter	Description	Value Range	Default
Mix	Level of effect itself	0-255	0
Left	Left	0-65535	0
Left R	Left R	0-65535	32768
Right	Right	0-65535	0
Right R	Right R	0-65535	32768
Top	Top	0-65535	0
Top R	Top R	0-65535	32768
Bottom	Bottom	0-65535	0
Bottom R	Bottom R	0-65535	32768

▼ **Softborder RGBA**

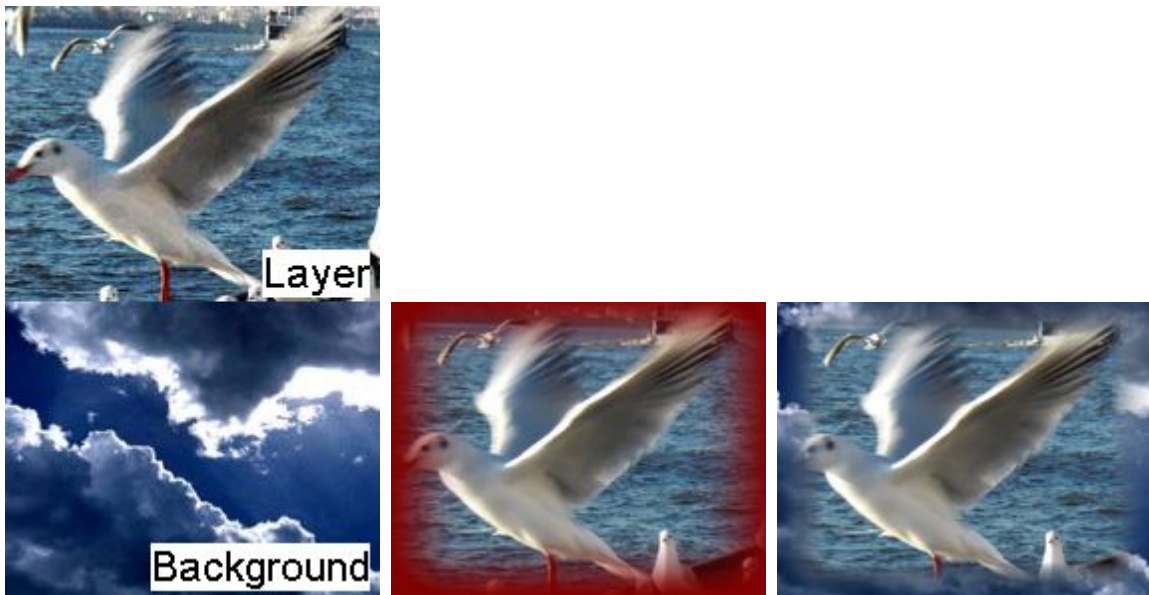

Adds a softborder to all edges. The border size and roundness of the corners can be adjusted. The color and transparency of the border can be set with the color and alpha mix parameters.

Parameter	Description	Value Range	Default
Mix	Level of Effect	0-255	0
Size	Size of softborder	0-255	16
Corner	Softness of corner	0-255	0
Red	Red level, Color Picker	0-255	128
Green	Green level, Color Picker	0-255	128
Blue	Blue level, Color Picker	0-255	128
Alpha	Alpha level of the border area	0-255	128

▼ **Softborder**



Adds a softborder to all edges. The border size and roundness of the corners can be adjusted. The color of the border is transparent.

Parameter	Description	Value Range	Default
Mix	Level of Effect	0-255	0
Size	Size of softborder	0-255	16
Corner	Softness of corner	0-255	0

### 5.4.2.11.17 DISTORT

#### ▼ Displace



Displaces the pixels of the target image.

Parameter	Description	Value Range	Default
Mix	Level of Effect	0-255	0
Offset	Amount of displacement	0-65535	32768

#### ▼ Distort



Distorts the image, using factorized UV mapping offsets.

Parameter	Description	Value Range	Default
Mix	Level of Effect	0-255	0
U Offset	Offset of U Mapping	0-65535	32768
V Offset	Offset of V Mapping	0-65535	32768
U Factor	Factor of U Mapping	0-65535	32768
V Factor	Factor of V Mapping	0-65535	32768

▼ Fluid Color

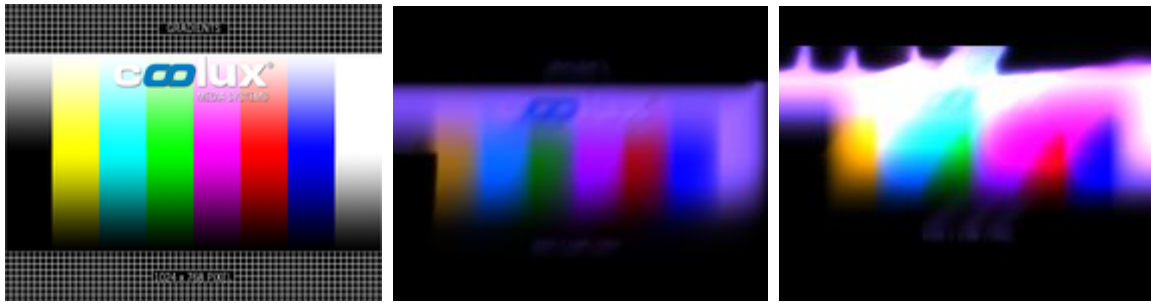

This effect multiplies the FX texture with a color and adds a fluid effect which is best seen when applied to a video layer. According to the Offset and Velocity parameters, the frames of this result change their position which creates the impression, the frames would fly into a (changing) direction. With the "Density difference" fader you can change how many frames are multiplied into the Layer texture and with "Velocity Factor" how far frames move. The last image shows a higher velocity than in the second image.

Parameter	Description	Value Range	Default
Mix	Level of effect itself	0-255	0
Vel Dir	Vel Dir	0-65535	32768
Offset	Offset	0-65535	0
Offs. Freq.	Offs. Freq.	0-65535	32768
Vel Input	Vel Input	0-65535	6553
Vel Factor	Vel Factor	0-65535	5242
Vel Cutoff	Vel Cutoff	0-65535	13000
Vel Diff	Vel Diff	0-65535	63000
Den Diff	Den Diff	0-65535	63000
Red	Color picker / Level of red	0-255	255
Green	Color picker / Level of green	0-255	255
Blue	Color picker / Level of blue	0-255	255

▼ Fluid Mask

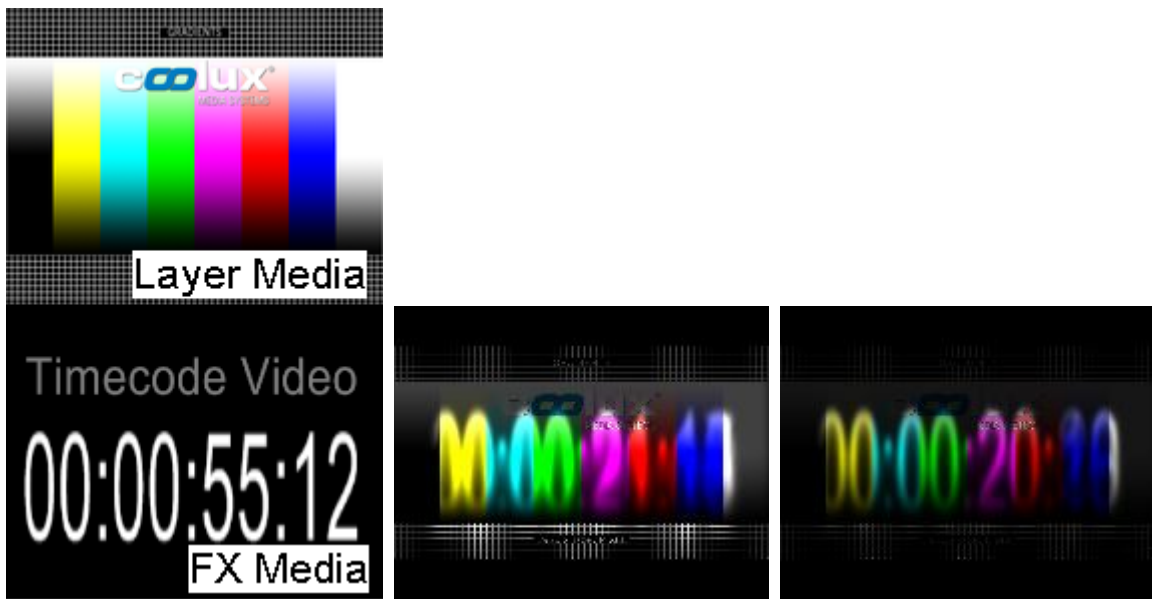

This effect multiplies the FX texture with the Layer texture and adds a fluid effect which is best seen when applied to a video layer.

According to the Offset and Velocity parameters, the frames of this result change their position slightly which creates the impression they are blurred fluidly.

With the "Density difference" fader you can change how many frames are multiplied into the Layer texture. The last image shows a lower difference, resulting in a darker image and in a clearer FX media. "Invert RGB" inverts the FX texture before its mixed to the Layer.

Parameter	Description	Value Range	Default
Mix	Level of effect itself	0-255	0
Media	Media file as source for overlay or mask	-	-
Vel Dir	Vel Dir	0-65535	32768
Offset	Offset	0-65535	0
Offs. Freq.	Offs. Freq.	0-65535	32768
Vel Input	Vel Input	0-65535	6553
Vel Factor	Vel Factor	0-65535	5242
Vel Cutoff	Vel Cutoff	0-65535	13000
Vel Diff	Vel Diff	0-65535	63000
Den Diff	Density Difference	0-65535	63000
Inv. RGB	Invert RGB levels from FX media	0-255	0
Inv. Alpha	Inverts transparency from FX media	0-255	0

▼ Fluid Paint

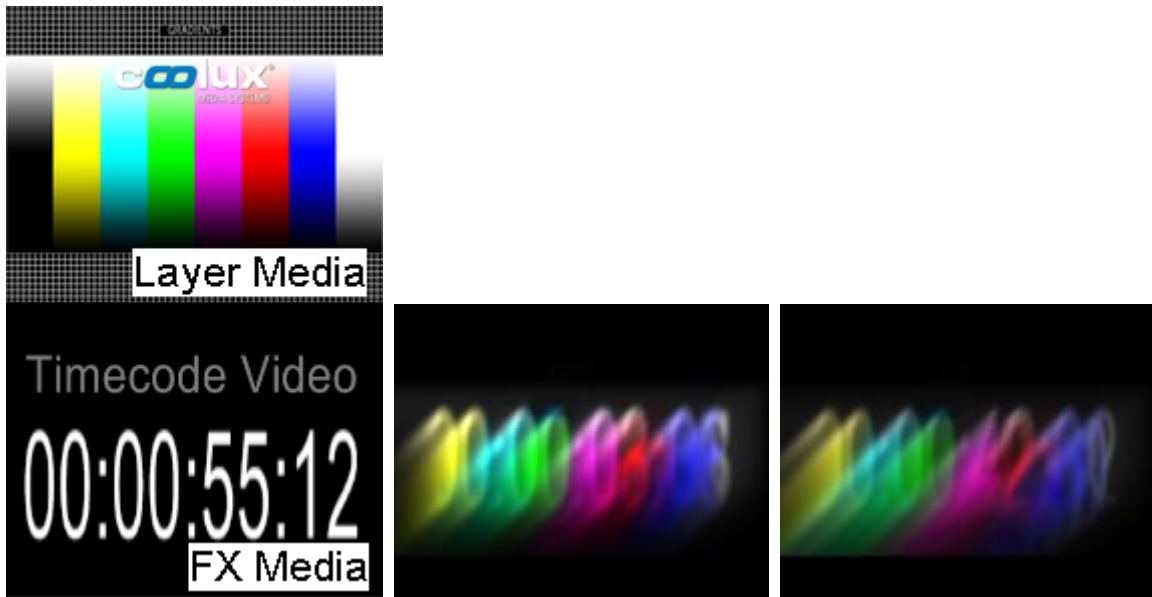

This effect multiplies the FX texture with the Layer texture and adds a fluid effect which is best seen when applied to a video layer.

According to the Offset and Velocity parameters, the frames of this result change their position which creates the impression, the frames would fly into a (changing) direction.

With the "Density difference" fader you can change how many frames are multiplied into the Layer texture and with "Velocity Factor" how far frames move. The last image shows a higher velocity than in the second image.

Parameter	Description	Value Range	Default
Mix	Level of effect itself	0-255	0
Media	Media file as source for overlay or mask	-	-
Vel Dir	Vel Dir	0-65535	32768
Offset	Offset	0-65535	0
Offs. Freq.	Offs. Freq.	0-65535	32768
Vel Input	Vel Input	0-65535	6553
Vel Factor	Vel Factor	0-65535	5242
Vel Cutoff	Vel Cutoff	0-65535	13000
Vel Diff	Vel Diff	0-65535	63000
Den Diff	Den Diff	0-65535	63000

▼ Interactive Waves Buffer RH



This effect is based on the Layer's Z Position or render history as explained in the manual chapter "[Compositing](#)"<sup>386</sup>. The layer with the assigned effect makes a composition of all layers behind it and displays it atop its own texture. In the example, the "render" layer is positioned in the foreground, its main media is a transparent image. In the background there is a video layer showing a running timecode and a [particle system](#)<sup>182</sup> (also with a transparent media!).

Whenever a pixel from the composition changes, it causes waves as if a rain drop deformed the rendering texture.

The parameter "Strenght" influences the wave speed / frequency, whilst "Delay" influences the amplitude, i.e. how far the waves go).

Parameter	Description	Value Range	Default
Mix	Level of effect itself	0-255	0
Strength	Strength	0-255	0
Delay	Delay	0-65535	60000

▼ Interactive Waves Buffer



The main media from the layer is a transparent image whilst the effect's media is video showing a running timecode. Whenever a pixel from the timecode video changes, it causes waves as if a rain drop deformed the rendering texture.

The parameter "Strenght" influences the wave speed / frequency, whilst "Delay" influences the amplitude, i.e. how far the waves go).

Parameter	Description	Value Range	Default
-----------	-------------	-------------	---------

Mix	Level of effect itself	0-255	0
Strength	Strength	0-255	0
Delay	Delay	0-65535	60000
Media	Media file as source for waves	-	-

▼ **Interactive Waves RH**



This effect is based on the Layer's Z Position or render history as explained in the manual chapter "[Compositing](#)"<sup>386</sup>. The layer with the assigned effect makes a composition of all layers behind it and mixes it into its own texture. In the example, the "render" layer is positioned in the foreground, its main media is a grass image. In the background there is a video layer showing a running timecode and a [particle system](#)<sup>182</sup> (also with a transparent media!). Whenever a pixel from the composition changes, it causes waves as if a rain drop deformed the rendering grass texture. The parameter "Strenght" influences the wave speed / frequency, whilst "Delay" influences the amplitude, i.e. how far the waves go). "Offset" offsets the grass texture in the waves.

Parameter	Description	Value Range	Default
Mix	Level of effect itself	0-255	0
Strength	Strength	0-255	0
Offset	Offset	0-65535	32768
Delay	Delay	0-65535	60000

▼ **Interactive Waves**

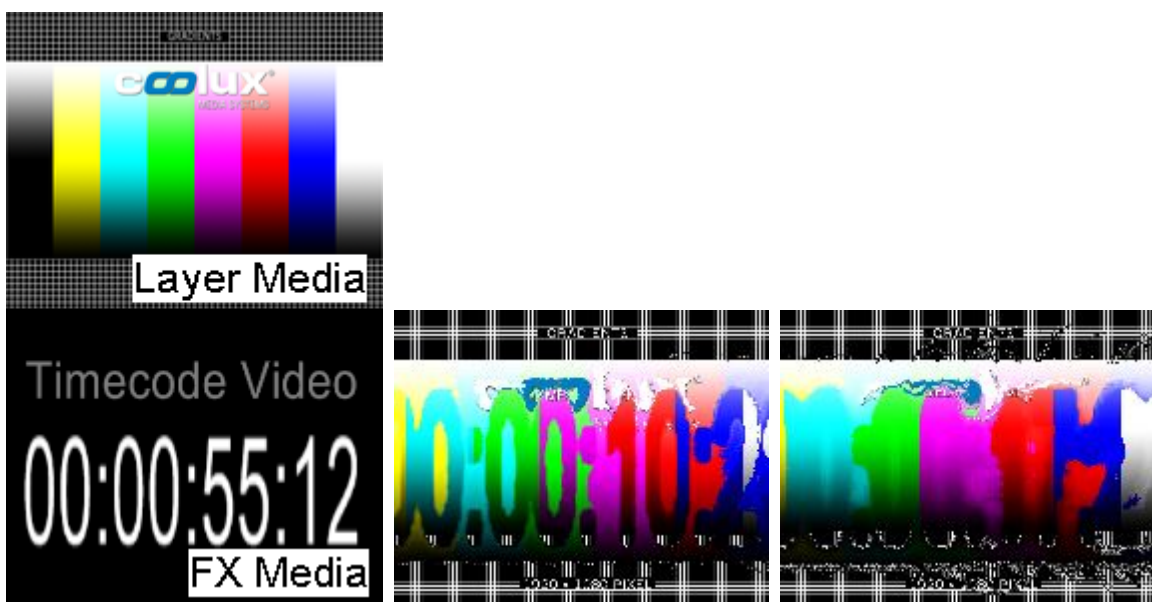



The main media from the layer is a color gradients image whilst the effect's media is video showing a running timecode. Whenever a pixel from the timecode video changes, it causes waves as if a rain drop deformed the rendering color gradient texture.

The parameter "Strenght" influences the wave speed / freuquency, whilst "Delay" influences the amplitude, i.e. how far the waves go). "Offset" offsets the grass texture in the waves.

Parameter	Description	Value Range	Default
Mix	Level of effect itself	0-255	0
Strength	Strength	0-255	0
Offset	Offset	0-65535	32768
Delay	Delay	0-65535	60000
Media	Media file as source for waves	-	-

▼ **Lens Barrel Distortion Color Corr**

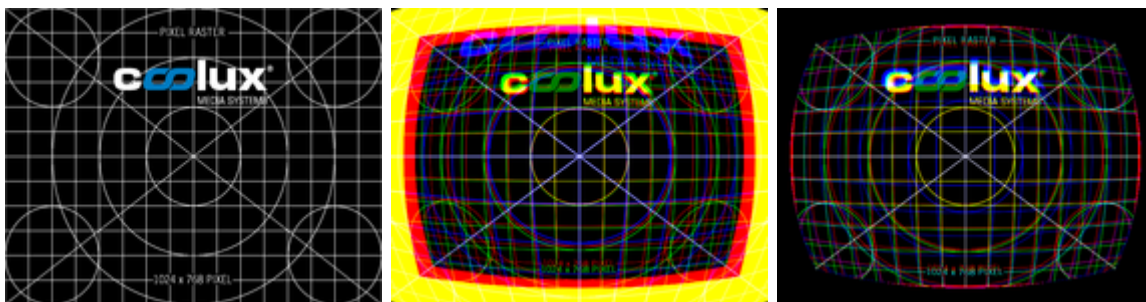

Applies a barrel distortion to a layer or output texture. In addition it applies a correction for chromatic aberration which is for example of interest when working with a device like an Oculus Rift.

Parameter	Description	Value Range	Default
Mix	Level of effect itself	0-255	0
Lens X	Horizontal lens position	0-65535	32768
Lens Y	Vertical lens position	0-65535	32768
Scale X	Horizontal scale	0-65535	32768
Scale Y	Vertical scale	0-65535	32768
ScaleIn X	Horizontal scale	0-65535	32768
ScaleIn Y	Vertical scale	0-65535	32768
Coef. 0	Coef. 0	0-65535	65535
Coef. 1	Coef. 1	0-65535	32768
Coef. 2	Coef. 2	0-65535	32768
Coef. 3	Coef. 3	0-65535	32768

▼ **Lens Barrel Distortion**

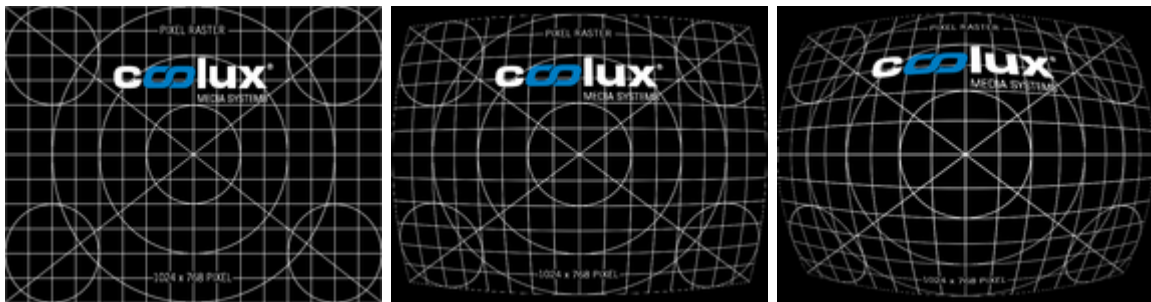

Applies a barrel distortion to a layer or output texture.

Parameter	Description	Value Range	Default
Mix	Level of effect itself	0-255	0
Lens X	Horizontal lens position	0-65535	32768
Lens Y	Vertical lens position	0-65535	32768
Scale X	Horizontal scale	0-65535	32768
Scale Y	Vertical scale	0-65535	32768
ScaleIn X	Horizontal scale	0-65535	32768
ScaleIn Y	Vertical scale	0-65535	32768
Coef. 0	Coef. 0	0-65535	65535
Coef. 1	Coef. 1	0-65535	32768
Coef. 2	Coef. 2	0-65535	32768
Coef. 3	Coef. 3	0-65535	32768

▼ **Lens Pincushion Distortion**



Applies a pincushion distortion to a layer or output texture.

Parameter	Description	Value Range	Default
Mix	Level of effect itself	0-255	0
Lens X	Horizontal lens position	0-65535	32768
Lens Y	Vertical lens position	0-65535	32768
Scale X	Horizontal scale	0-65535	32768
Scale Y	Vertical scale	0-65535	32768
ScaleIn X	Horizontal scale	0-65535	32768
ScaleIn Y	Vertical scale	0-65535	32768
Coef. 0	Coef. 0	0-65535	65535
Coef. 1	Coef. 1	0-65535	32768

Coef. 2	Coef. 2	0-65535	32768
Coef. 3	Coef. 3	0-65535	32768

▼ **Magnify Glass**



Magnifies an area of the layer image and allows to define the position and size of this area as well as the used zoom factor.

Parameter	Description	Value Range	Default
Mix	Level of Effect	0-255	0
X	X Position of magnifier	0-65535	32768
Y	Y Position of magnifier	0-65535	32768
In	Size of completely magnified area	0-65535	16448
Out	Size of area where magnification ends	0-65535	17733
Magnify	Amount of magnification	0-65535	32768
Aspect	Aspect ratio of magnifier	0-65535	42662

▼ **PolarCoordinates**



Polar Coordinates Effect. Can be used to either treat current coordinates as Cartesian and Resample to Polar or vice versa. Created by Florian Mosleh [www.s2gfx.com](http://www.s2gfx.com)

Parameter	Description	Value Range	Default
Mix	Level of effect itself	0-255	0
Operation	Operation	0-255	0

▼ **Ripple Animation**



Distorts the texture with a ripple animation. Amplitude, frequency, motion speed and direction as well as size and position can be set up.

Parameter	Description	Value Range	Default
Mix	Level of Effect	0-255	0
Amplitude	Defines the height of the ripple's amplitude	0-65535	16384
Frequency	Defines the ripple's frequency (=amount of ripples coming out from its center)	0-65535	32768
Motion	Defines the speed and direction of the ripple's motion	0-65535	16448
Pos U	U Position	0-65535	17733
Pos V	V Position	0-65535	32768
Scale U	U Scale	0-65535	16384
Scale V	V Scale	0-65535	16384

▼ **Ripple**



Distorts the texture with a non-animated ripple effect. Amplitude, frequency, phase as well as size and position can be set up.

Parameter	Description	Value Range	Default
Mix	Level of Effect	0-255	0
Amplitude	Defines the height of the ripple's amplitude	0-65535	16384
Frequency	Defines the ripple's frequency (=amount of ripples coming out from its center)	0-65535	32768
Phase	Define the phase of the ripple's curve	0-65535	16448
Pos U	U Position	0-65535	17733
Pos V	V Position	0-65535	32768
Scale U	U Scale	0-65535	16384
Scale V	V Scale	0-65535	16384

▼ Swirl Angle

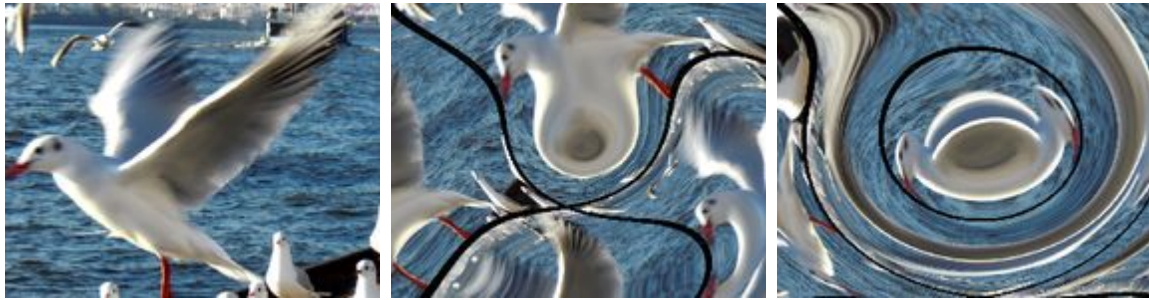

Distorts the texture with a non-animated swirl effect. Twist, Depth and Amount can be set up.

Parameter	Description	Value Range	Default
Mix	Level of Effect	0-255	0
Twist	Amount of Twist	0-65535	128
Depth	Depth of the Swirl	0-65535	4096
Amount	Amount of swirl waves	0-65535	2048

▼ Texture Morph

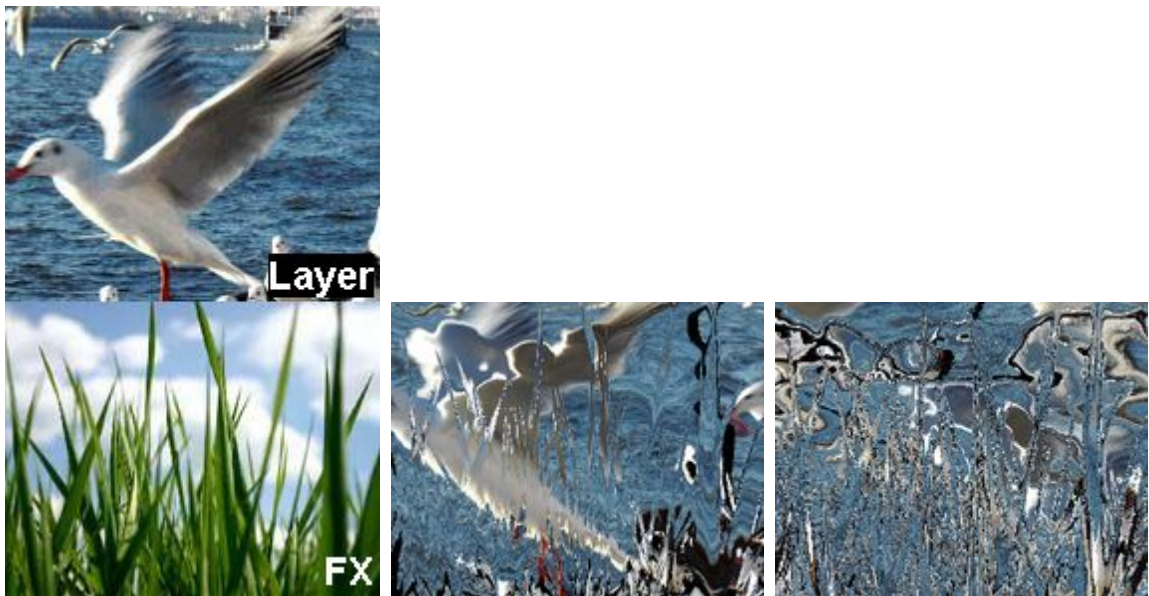

Morphs the image by using an additional media file as texture.

Parameter	Description	Value Range	Default
Media	Add the image file that should be used as texture for the morph effect		
Mix	Level of Effect	0-255	0
Factor	Amount of Texture Morphing	0-255	64

▼ Waves



Modifies the texture with non-animated waves.

Parameter	Description	Value Range	Default
Mix	Level of Effect	0-255	0
Amount	Amount of Waves	0-65535	64000
U Offset	U Mapping Offset (in X direction)	0-65535	32768
V Offset	V Mapping Offset (in Y direction)	0-65535	32768

### 5.4.2.11.18 FRACTALS

#### ▼ ++ General information for Fractal Effects ++

A fractal is a geometric pattern that is repeated at ever smaller scales to produce irregular shapes and surfaces that cannot be represented by classical geometry. Fractals are used especially in computer modeling of irregular patterns and structures in nature.

#### ▼ Julia Fractal

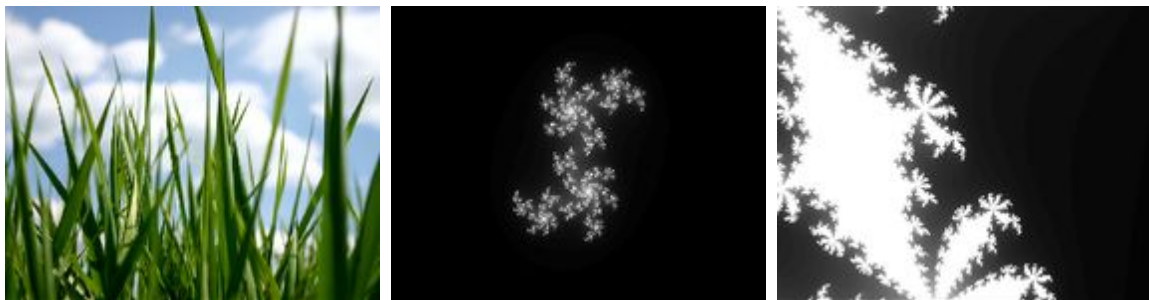

Shows a Julia Fractal that can be modified by Zoom, Position and Seed Parameters. The texture being originally on the layer does not influence this effect except during blending.

Parameter	Description	Value Range	Default
Mix	Level of Effect	0-255	0
Zoom	Zoom into the fractal	0-65535	32768
Pos U	Pos U	0-65535	32768
Pos V	Pos V	0-65535	32768
Seed X	Seed X	0-65535	25000
Seed Y	Seed Y	0-65535	25000

#### ▼ Mandelbrot Fractal

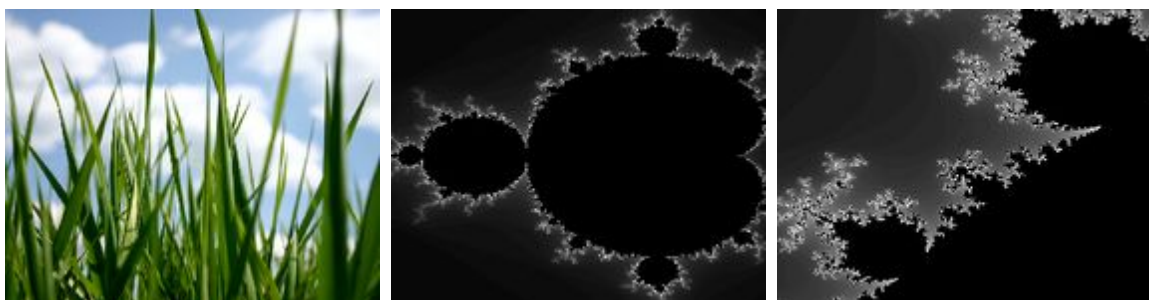

Shows a Mandelbrot Fractal that can be modified by Zoom, Aspect Ratio and Position Parameters. The texture being originally on the layer does not influence this effect except during blending.

Parameter	Description	Value Range	Default
Mix	Level of Effect	0-255	0
Zoom	Zoom into the fractal	0-65535	32768
Aspect	Defines the Aspect Ratio of the Fractal	0-65535	16384
Pos U	Pos U	0-65535	32768
Pos V	Pos V	0-65535	32768

### 5.4.2.11.19 FX COLLECTIONS

#### ▼ ++ General information for FX Collections ++

These FX collections will be added automatically when starting a Server or Player in Lighting Console Mode. Depending on your PB product a different amount of these effects will be already added to the layers and automatically patched in the Patch tab as well.



Depending on the Effect chosen from the "FX Name" list on the left, all or several of the FX Faders will get active, displaying the name of their function instead of FX1, FX2 etc. Example:



When the Effect "Frame RGBA" is chosen from the list, all faders are renamed according to their function in this effect. The last two faders in this example are without function (n/a).

All effects listed under the FX Name list are explained in the [FX theme collections](#)<sup>328</sup>, so please have a look here to receive more information about each effect.

#### ▼ Server FX 16bit 9Ch

Effects containing 9 channels (parameters) with 16 bit for each channel, available for PB Server products, see example above.

#### ▼ Player FX 16bit 4Ch

Effects containing 4 channels (parameters) with 16 bit for each channel, available for PB Player products, similar to the example above.



### 5.4.2.11.20 GENERATOR

#### ▼ RND Noise Add



Adds the RGB values of a random noise texture (animated) with the RGB values of the layer's texture. Size of noise can be adjusted.

Parameter	Description	Value Range	Default
Mix	Level of Effect	0-255	0
Size	Size of noisy items	0-65535	64

#### ▼ RND Noise Divide



Divides the RGB values of a random noise texture (animated) with the RGB values of the layer's texture. Size of noise can be adjusted.

Parameter	Description	Value Range	Default
Mix	Level of Effect	0-255	0
Size	Size of noisy items	0-65535	64

#### ▼ RND Noise Mix



Fades into a random noise texture (animated). Size of noise can be adjusted.

Parameter	Description	Value Range	Default
-----------	-------------	-------------	---------

Mix	Level of Effect	0-255	0
Size	Size of noisy items	0-65535	64

▼ **RND Noise Multiply**



Multiplies the RGB values of a random noise texture (animated) with the RGB values of the layer's texture. Size of noise can be adjusted.

Parameter	Description	Value Range	Default
Mix	Level of Effect	0-255	0
Size	Size of noisy items	0-65535	64

▼ **RND Noise Subtract**



Subtracts the RGB values of a random noise texture (animated) with the RGB values of the layer's texture. Size of noise can be adjusted.

Parameter	Description	Value Range	Default
Mix	Level of Effect	0-255	0
Size	Size of noisy items	0-65535	64

### 5.4.2.11.21 GEOMETRY

#### ▼ Inflate



Inflates the layer in XYZ, best visible when having a 3D object applied as Mesh. Using just the 2D layer texture (without a mesh!) results in inflating the layer in X&Y, and moving the layer in Z Position closer to the camera.

Parameter	Description	Value Range	Default
Amount	Amount of Inflation	0-65535	0

#### ▼ Lens Barrel Distortion - Vertex

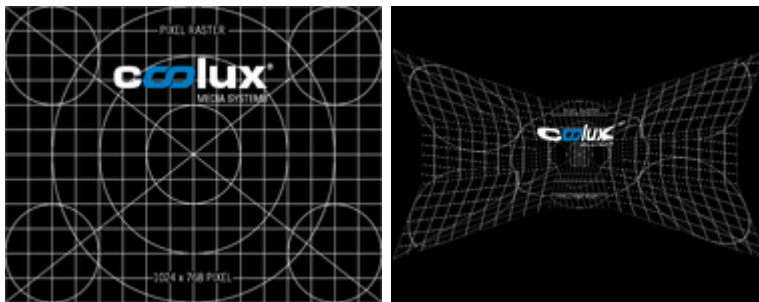

Applies a barrel distortion to a layer or output.

Parameter	Description	Value Range	Default
Lens X	Horizontal lens position	0-65535	32768
Lens Y	Vertical lens position	0-65535	32768
Scale X	Horizontal scale	0-65535	32768
Scale Y	Vertical scale	0-65535	32768
ScaleIn X	Horizontal scale	0-65535	32768
ScaleIn Y	Vertical scale	0-65535	32768
Coef. 0	Coef. 0	0-65535	65535
Coef. 1	Coef. 1	0-65535	0
Coef. 2	Coef. 2	0-65535	0
Coef. 3	Coef. 3	0-65535	0

▼ **Lens Pincushion Distortion - Vertex**

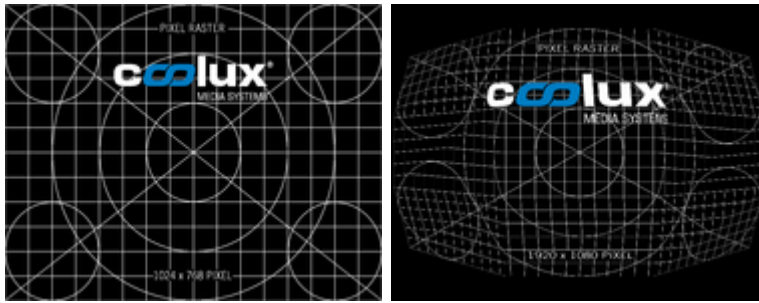

Applies a barrel distortion to a layer or output.

Parameter	Description	Value Range	Default
Lens X	Horizontal lens position	0-65535	32768
Lens Y	Vertical lens position	0-65535	32768
Scale X	Horizontal scale	0-65535	32768
Scale Y	Vertical scale	0-65535	32768
ScaleIn X	Horizontal scale	0-65535	32768
ScaleIn Y	Vertical scale	0-65535	32768
Coef. 0	Coef. 0	0-65535	65535
Coef. 1	Coef. 1	0-65535	0
Coef. 2	Coef. 2	0-65535	0
Coef. 3	Coef. 3	0-65535	0

▼ **Morph A-B**

This effect allows deforming an object by moving its vertices from one assembly to another. Please refer to this [live warping tutorial](#)<sup>828</sup> in the manual.

▼ **Morph A-B-C**

This effect allows deforming an object by moving its vertices from one assembly to a second and a third one. Please refer to the [live warping tutorial](#)<sup>828</sup> in the manual.

▼ **Rotate Local Quaternion**

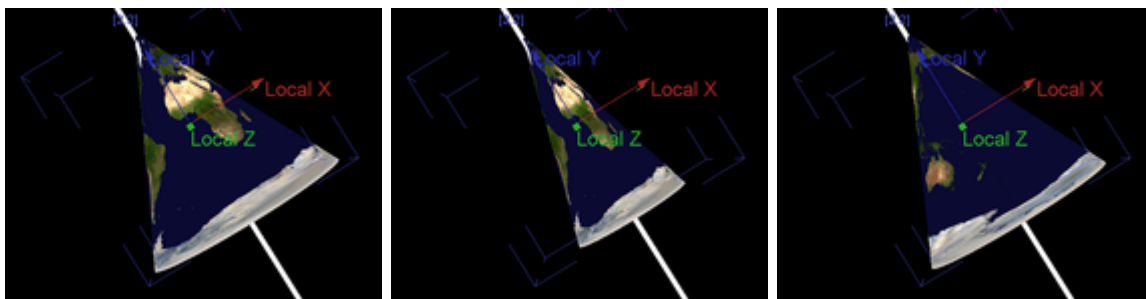

The rotation set up with the default XYZ rotation parameters from a layer depends on the rotation pivot's position. It rotates the object as well as the rotation pivot point. In contrary, the "Rotate Local Quaternion" parameters apply locally, independent from the pivot's

position but using its orientation. It rotates only the object not the rotation pivot point.  
 The "Rotate Local Quaternion" applies a fixed rotation value based on quaternion parameters in difference to the standard summarization of Euler XYZ rotation angles.

Parameter	Description	Value Range	Default
QX	QX	-1-1	0
QY	QY	-1-1	0
QZ	QZ	-1-1	0
QW	QW	-1-1	0

▼ **Rotate Local XYZ**

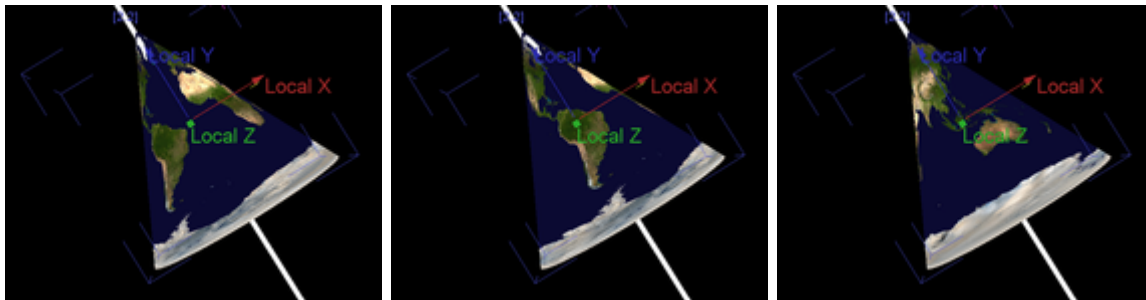

The rotation set up with the default XYZ rotation parameters from a layer depends on the rotation pivot's position. It rotates the object as well as the rotation pivot point.  
 In contrary, the "Rotate Local XYZ" parameters apply locally, independent from the pivot's position but using its orientation. It rotates only the object not the rotation pivot point.  
 The "Rotate Local XYZ" applies a fixed rotation value, whilst "Rotation Speed Local XYZ" applies a constant rotation over time.

Parameter	Description	Value Range	Default
X	Rotation of local X Axis	0-65535	32768
Y	Rotation of local Y Axis	0-65535	32768
Z	Rotation of local Z Axis	0-65535	32768

▼ **Rotation Speed Local XYZ**

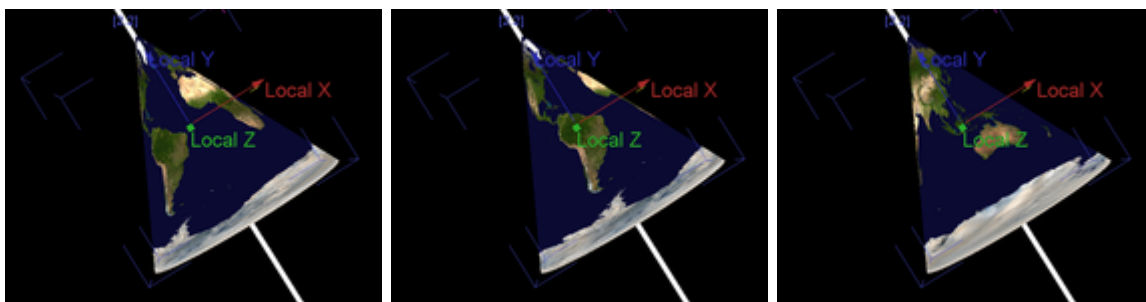

The rotation set up with the default XYZ rotation parameters from a layer depends on the rotation pivot's position. It rotates the object as well as the rotation pivot point.  
 In contrary, the "Rotate Local XYZ" parameters apply locally, independent from the pivot's position but using its orientation. It rotates only the object not the rotation pivot point.  
 The "Rotate Local XYZ" applies a fixed rotation value, whilst "Rotation Speed Local XYZ" applies a constant rotation over time.

Parameter	Description	Value Range	Default
-----------	-------------	-------------	---------

X	X	0-65535	32768
Y	Y	0-65535	32768
Z	Z	0-65535	32768

▼ XYZ Push



Pushes the layer texture in XYZ, depending on the settings of XYZ pivots.

Example above:

Left: Effect is not applied

Center: Y Offset is applied; Y Pivot is centered (default value)

Right: X Offset is applied; X Pivot is moved to right edge of the layer

Parameter	Description	Value Range	Default
X Off	X Offset	0-65535	32768
Y Off	Y Offset	0-65535	32768
Z Off	Z Offset	0-65535	32768
PX	Position of X Pivot	0-65535	32768
PY	Position of Y Pivot	0-65535	32768
PZ	Position of Z Pivot	0-65535	32768

▼ XYZ Squeeze

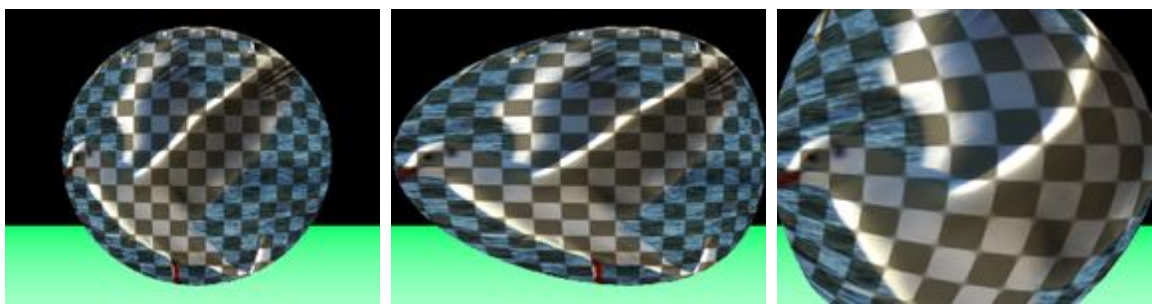

Squeezes the layer texture in XYZ, depending on the settings of XYZ pivots.

Parameter	Description	Value Range	Default
X Off	X Offset	0-65535	0
Y Off	Y Offset	0-65535	0
Z Off	Z Offset	0-65535	0
PX	Position of X Pivot	0-65535	32768
PY	Position of Y Pivot	0-65535	32878
PZ	Position of Z Pivot	0-65535	32768

### 5.4.2.11.22 GRADIENTS

#### ▼ Gradient Linear Horizontal



Allows turning the layer texture into a linear gradient with the possibility of choosing the colors for the horizontal area. Alpha layers for both areas are adjustable.

Parameter	Description	Value Range	Default
Mix	Level of effect itself	0-255	0
Red	Color picker / Level of red	0-255	255
Green	Color picker / Level of green	0-255	255
Blue	Color picker / Level of blue	0-255	255
Alpha	Level of transparency	0-255	255
Red C	Red C	0-255	0
Green C	Green C	0-255	0
Blue C	Blue C	0-255	0
Alpha C	Alpha C	0-255	255

#### ▼ Gradient Linear Vertical

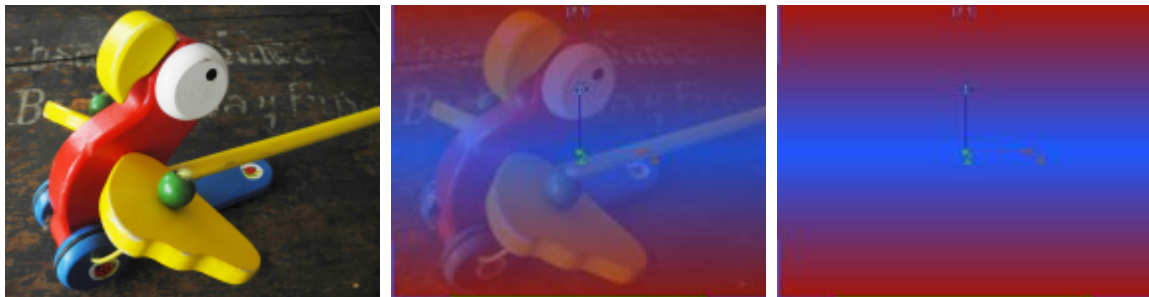

Allows turning the layer texture into a linear gradient with the possibility of choosing the colors for the vertical area. Alpha layers for both areas are adjustable.

Parameter	Description	Value Range	Default
Mix	Level of effect itself	0-255	0
Red	Color picker / Level of red	0-255	255
Green	Color picker / Level of green	0-255	255
Blue	Color picker / Level of blue	0-255	255
Alpha	Level of transparency	0-255	255
Red C	Red C	0-255	0
Green C	Green C	0-255	0
Blue C	Blue C	0-255	0

Alpha C      Alpha C      0-255      255

▼ **Gradient Linear**



Allows turning the layer texture into a linear gradient with the possibility of choosing the colors for the higher and lower area. Alpha levels for both areas are adjustable.

Parameter	Description	Value Range	Default
Mix	Level of Effect	0-255	0
Red H	Red level of higher color, Color Picker	0-255	255
Green H	Green level of higher color, Color Picker	0-255	255
Blue H	Blue level of higher color, Color Picker	0-255	255
Alpha H	Alpha level of higher color	0-255	255
Red L	Red level of lower color, Color Picker	0-255	0
Green L	Green level of lower color, Color Picker	0-255	0
Blue L	Blue level of lower color, Color Picker	0-255	0
Alpha L	Alpha level of lower color	0-255	255

▼ **Gradient Quad 16bit**



Allows turning the layer texture into a gradient with four different areas with the possibility of choosing 16 bit colors and alpha channels. Size and softness of the quadrangle (four-sided figure) are adjustable.

This effect can be used for [blacklevel adjustment](#)<sup>613</sup>, when it is assigned to the output or to a layer that is toggled into the [Output Rendering Pass](#)<sup>297</sup> by using the [Layer Inspector](#)<sup>208</sup>.

Parameter	Description	Value Range	Default
Mix	Level of effect itself	0-255	0
Pt1 X	Horizontal position of the first point	0-65535	0
Pt1 Y	Vertical position of the first point	0-65535	65535
Red 1	First color picker / Level of red	0-65535	65535
Green 1	First color picker / Level of green	0-65535	65535



Blue 1	First color picker / Level of blue	0-65535	65535
Alpha 1	Alpha 1	0-65535	65535
Softness 1	Softness 1	0-65535	250
Pt2 X	Horizontal position of the second point	0-65535	65535
Pt2 Y	Vertical position of the second point	0-65535	65535
Red 2	Second color picker / Level of red	0-65535	65535
Green 2	Second color picker / Level of green	0-65535	0
Blue 2	Second color picker / Level of blue	0-65535	0
Alpha 2	Alpha 2	0-65535	65535
Softness 2	Softness 2	0-65535	250
Pt3 X	Horizontal position of the third point	0-65535	65535
Pt3 Y	Vertical position of the third point	0-65535	0
Red 3	Third color picker / Level of red	0-65535	0
Green 3	Third color picker / Level of green	0-65535	65535
Blue 3	Third color picker / Level of blue	0-65535	0
Alpha 3	Alpha 3	0-65535	65535
Softness 3	Softness 3	0-65535	250
Pt4 X	Horizontal position of the fourth point	0-65535	0
Pt4 Y	Vertical position of the fourth point	0-65535	0
Red 4	Fourth color picker / Level of red	0-65535	0
Green 4	Fourth color picker / Level of green	0-65535	0
Blue 4	Fourth color picker / Level of blue	0-65535	65535
Alpha 4	Alpha 4	0-65535	65535
Softness 4	Softness 4	0-65535	250

▼ Gradient Quad Black Lift 16bit

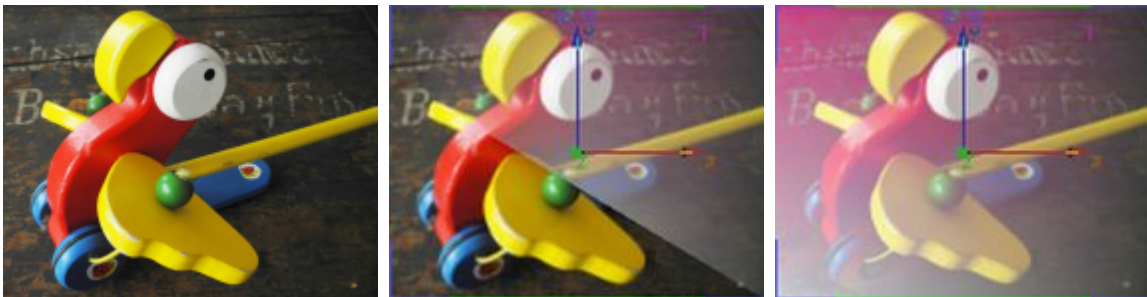

Allows turning the layer texture into a gradient with four different areas with the possibility of choosing 16 bit colors and alpha channels. Size and softness of the quadrangle (four-sided figure) are adjustable. The gradient colors are added to the layer texture but only to dark values. The higher the "Threshold" parameter the lighter the colors get that are influenced by the gradient colors.

This effect can be used for [blacklevel adjustment](#)<sup>613</sup>, when it is assigned to the output or to a layer that is toggled into the [Output Rendering Pass](#)<sup>297</sup> by using the [Layer Inspector](#)<sup>208</sup>.

Parameter	Description	Value Range	Default
Mix	Level of effect itself	0-255	0
Pt1 X	Horizontal position of the first point	0-65535	0
Pt1 Y	Vertical position of the first point	0-65535	65535

Red 1	First color picker / Level of red	0-65535	10000
Green 1	First color picker / Level of green	0-65535	10000
Blue 1	First color picker / Level of blue	0-65535	10000
Alpha 1	Alpha 1	0-65535	65535
Softness 1	Softness 1	0-65535	0
Pt2 X	Horizontal position of the second point	0-65535	65535
Pt2 Y	Vertical position of the second point	0-65535	65535
Red 2	Second color picker / Level of red	0-65535	10000
Green 2	Second color picker / Level of green	0-65535	10000
Blue 2	Second color picker / Level of blue	0-65535	10000
Alpha 2	Alpha 2	0-65535	65535
Softness 2	Softness 2	0-65535	0
Pt3 X	Horizontal position of the third point	0-65535	65535
Pt3 Y	Vertical position of the third point	0-65535	0
Red 3	Third color picker / Level of red	0-65535	10000
Green 3	Third color picker / Level of green	0-65535	10000
Blue 3	Third color picker / Level of blue	0-65535	10000
Alpha 3	Alpha 3	0-65535	65535
Softness 3	Softness 3	0-65535	0
Pt4 X	Horizontal position of the fourth point	0-65535	0
Pt4 Y	Vertical position of the fourth point	0-65535	0
Red 4	Fourth color picker / Level of red	0-65535	10000
Green 4	Fourth color picker / Level of green	0-65535	10000
Blue 4	Fourth color picker / Level of blue	0-65535	10000
Alpha 4	Alpha 4	0-65535	65535
Softness 4	Softness 4	0-65535	0
Threshold	Threshold	0-65535	30000

▼ Gradient Quad Black Lift



Allows turning the layer texture into a gradient with four different areas with the possibility of choosing 8 bit colors and alpha channels. Size and softness of the quadrangle (four-sided figure) are adjustable. The gradient colors are added to the layer texture but only to dark values. The higher the "Threshold" parameter the lighter the colors get that are influenced by the gradient colors.

This effect can be used for [blacklevel adjustment](#)<sup>613</sup>, when it is assigned to the output or to a layer that is toggled into the [Output Rendering Pass](#)<sup>297</sup> by using the [Layer Inspector](#)<sup>208</sup>.

Parameter	Description	Value Range	Default
-----------	-------------	-------------	---------

Mix	Level of effect itself	0-255	0
Pt1 X	Horizontal position of the first point	0-65535	0
Pt1 Y	Vertical position of the first point	0-65535	65535
Red 1	First color picker / Level of red	0-255	30
Green 1	First color picker / Level of green	0-255	30
Blue 1	First color picker / Level of blue	0-255	30
Alpha 1	Alpha 1	0-255	255
Softness 1	Softness 1	0-65535	0
Pt2 X	Horizontal position of the second point	0-65535	65535
Pt2 Y	Vertical position of the second point	0-65535	65535
Red 2	Second color picker / Level of red	0-255	30
Green 2	Second color picker / Level of green	0-255	30
Blue 2	Second color picker / Level of blue	0-255	30
Alpha 2	Alpha 2	0-255	255
Softness 2	Softness 2	0-65535	0
Pt3 X	Horizontal position of the third point	0-65535	65535
Pt3 Y	Vertical position of the third point	0-65535	0
Red 3	Third color picker / Level of red	0-255	30
Green 3	Third color picker / Level of green	0-255	30
Blue 3	Third color picker / Level of blue	0-255	30
Alpha 3	Alpha 3	0-255	255
Softness 3	Softness 3	0-65535	0
Pt4 X	Horizontal position of the fourth point	0-65535	0
Pt4 Y	Vertical position of the fourth point	0-65535	0
Red 4	Fourth color picker / Level of red	0-255	30
Green 4	Fourth color picker / Level of green	0-255	30
Blue 4	Fourth color picker / Level of blue	0-255	30
Alpha 4	Alpha 4	0-255	255
Softness 4	Softness 4	0-65535	0
Threshold	Threshold	0-255	75

▼ Gradient Quad



Allows turning the layer texture into a gradient with four different areas with the possibility of choosing 8 bit colors and alpha channels. Size and softness of the quadrangle (four-sided figure) are adjustable.

This effect can be used for [blacklevel adjustment](#)<sup>613</sup>, when it is assigned to the output or to a layer that is toggled into the [Output Rendering Pass](#)<sup>297</sup> by using the [Layer Inspector](#)<sup>208</sup>.

Parameter	Description	Value Range	Default
Mix	Level of effect itself	0-255	0
Pt1 X	Horizontal position of the first point	0-65535	0
Pt1 Y	Vertical position of the first point	0-65535	65535
Red 1	First color picker / Level of red	0-255	255
Green 1	First color picker / Level of green	0-255	255
Blue 1	First color picker / Level of blue	0-255	255
Alpha 1	Alpha 1	0-255	255
Softness 1	Softness 1	0-65535	250
Pt2 X	Horizontal position of the second point	0-65535	65535
Pt2 Y	Vertical position of the second point	0-65535	65535
Red 2	Second color picker / Level of red	0-255	255
Green 2	Second color picker / Level of green	0-255	0
Blue 2	Second color picker / Level of blue	0-255	0
Alpha 2	Alpha 2	0-255	255
Softness 2	Softness 2	0-65535	250
Pt3 X	Horizontal position of the third point	0-65535	65535
Pt3 Y	Vertical position of the third point	0-65535	0
Red 3	Third color picker / Level of red	0-255	0
Green 3	Third color picker / Level of green	0-255	255
Blue 3	Third color picker / Level of blue	0-255	0
Alpha 3	Alpha 3	0-255	255
Softness 3	Softness 3	0-65535	250
Pt4 X	Horizontal position of the fourth point	0-65535	0
Pt4 Y	Vertical position of the fourth point	0-65535	0
Red 4	Fourth color picker / Level of red	0-255	0
Green 4	Fourth color picker / Level of green	0-255	0
Blue 4	Fourth color picker / Level of blue	0-255	255
Alpha 4	Alpha 4	0-255	255
Softness 4	Softness 4	0-65535	250

▼ Gradient Radial

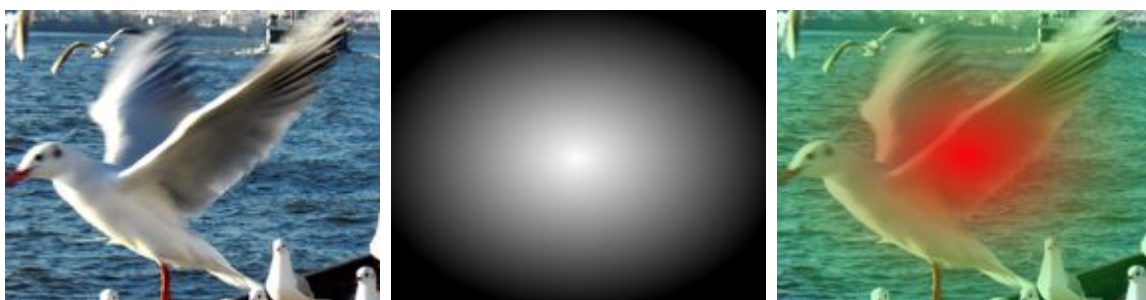

Allows turning the layer texture into a radial gradient with the possibility of choosing the colors for the higher and lower area. Alpha levels for both areas are adjustable.

Parameter	Description	Value Range	Default
Mix	Level of Effect	0-255	0
Red H	Red level of higher color, Color Picker	0-255	255
Green H	Green level of higher color, Color Picker	0-255	255
Blue H	Blue level of higher color, Color Picker	0-255	255
Alpha H	Alpha level of higher color	0-255	255
Red L	Red level of lower color, Color Picker	0-255	0
Green L	Green level of lower color, Color Picker	0-255	0
Blue L	Blue level of lower color, Color Picker	0-255	0
Alpha L	Alpha level of lower color	0-255	255

▼ Gradient Spiral



Allows turning the layer texture into a spiral gradient with the possibility of choosing the colors for the higher and lower area. Alpha levels for both areas are adjustable. The amount of the spiral is influenced by the opacity value of the layer as well.

Parameter	Description	Value Range	Default
Mix	Level of Effect	0-255	0
Red H	Red level of higher color, Color Picker	0-255	255
Green H	Green level of higher color, Color Picker	0-255	255
Blue H	Blue level of higher color, Color Picker	0-255	255
Alpha H	Alpha level of higher color	0-255	255
Red L	Red level of lower color, Color Picker	0-255	0
Green L	Green level of lower color, Color Picker	0-255	0
Blue L	Blue level of lower color, Color Picker	0-255	0
Alpha L	Alpha level of lower color	0-255	255

▼ Gradient Swirl

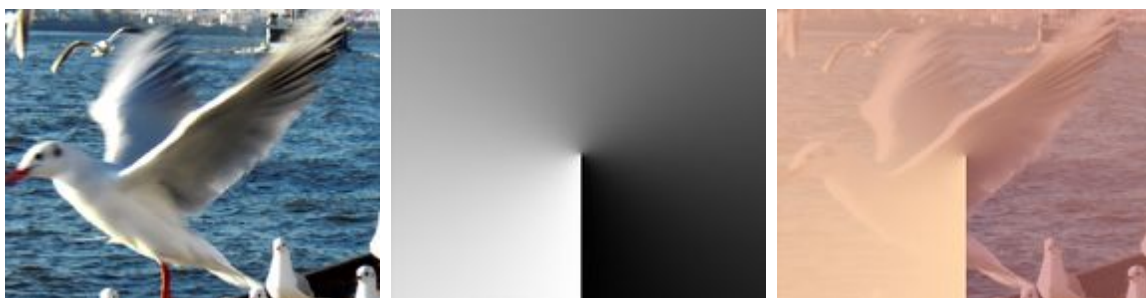

Allows turning the layer texture into a swirl gradient with the possibility of choosing the colors for the higher and lower area. Alpha levels for both areas are adjustable.

Parameter	Description	Value Range	Default
Mix	Level of Effect	0-255	0
Red H	Red level of higher color, Color Picker	0-255	255
Green H	Green level of higher color, Color Picker	0-255	255
Blue H	Blue level of higher color, Color Picker	0-255	255
Alpha H	Alpha level of higher color	0-255	255
Red L	Red level of lower color, Color Picker	0-255	0
Green L	Green level of lower color, Color Picker	0-255	0
Blue L	Blue level of lower color, Color Picker	0-255	0
Alpha L	Alpha level of lower color	0-255	255

▼ Gradient Triangle 16bit



Allows turning the layer texture into a gradient with three different areas with the possibility of choosing 16 bit colors and alpha channels. Size, softness and rotation angle of the triangular (3-sided figure) are adjustable. The gradient colors are added to the layer texture.

This effect can be used for [blacklevel adjustment](#)<sup>613</sup>, when it is assigned to the output or to a layer that is toggled into the [Output Rendering Pass](#)<sup>297</sup> by using the [Layer Inspector](#)<sup>208</sup>.

Parameter	Description	Value Range	Default
Mix	Level of effect itself	0-255	0
Pt1 X	Horizontal position of the first point	0-65535	0
Pt1 Y	Vertical position of the first point	0-65535	0
Red 1	First color picker / Level of red	0-65535	65535
Green 1	First color picker / Level of green	0-65535	65535
Blue 1	First color picker / Level of blue	0-65535	65535
Alpha 1	Alpha 1	0-65535	65535
Softness 1	Softness 1	0-65535	250
Pt2 X	Horizontal position of the second point	0-65535	32768
Pt2 Y	Vertical position of the second point	0-65535	65535
Red 2	Second color picker / Level of red	0-65535	65535
Green 2	Second color picker / Level of green	0-65535	0
Blue 2	Second color picker / Level of blue	0-65535	0
Alpha 2	Alpha 2	0-65535	65535
Softness 2	Softness 2	0-65535	250
Pt3 X	Horizontal position of the third point	0-65535	65535

Pt3 Y	Vertical position of the third point	0-65535	0
Red 3	Third color picker / Level of red	0-65535	0
Green 3	Third color picker / Level of green	0-65535	65535
Blue 3	Third color picker / Level of blue	0-65535	0
Alpha 3	Alpha 3	0-65535	65535
Softness 3	Softness 3	0-65535	250
Angle	Angle	0-360	180

▼ Gradient Triangle Black Lift 16bit



Allows turning the layer texture into a gradient with three different areas with the possibility of choosing 16 bit colors and alpha channels. Size, softness and rotation angle of the triangular (3-sided figure) are adjustable. The gradient colors are added to the layer texture but only to dark values. The higher the "Threshold" parameter the lighter the colors get that are influenced by the gradient colors.

This effect can be used for [blacklevel adjustment](#)<sup>613</sup>, when it is assigned to the output or to a layer that is toggled into the [Output Rendering Pass](#)<sup>297</sup> by using the [Layer Inspector](#)<sup>208</sup>.

Parameter	Description	Value Range	Default
Mix	Level of effect itself	0-255	0
Pt1 X	Horizontal position of the first point	0-65535	0
Pt1 Y	Vertical position of the first point	0-65535	0
Red 1	First color picker / Level of red	0-65535	10000
Green 1	First color picker / Level of green	0-65535	10000
Blue 1	First color picker / Level of blue	0-65535	10000
Alpha 1	Alpha 1	0-65535	65535
Softness 1	Softness 1	0-65535	0
Pt2 X	Horizontal position of the second point	0-65535	32768
Pt2 Y	Vertical position of the second point	0-65535	65535
Red 2	Second color picker / Level of red	0-65535	10000
Green 2	Second color picker / Level of green	0-65535	10000
Blue 2	Second color picker / Level of blue	0-65535	10000
Alpha 2	Alpha 2	0-65535	65535
Softness 2	Softness 2	0-65535	0
Pt3 X	Horizontal position of the third point	0-65535	65535
Pt3 Y	Vertical position of the third point	0-65535	0
Red 3	Third color picker / Level of red	0-65535	10000
Green 3	Third color picker / Level of green	0-65535	10000
Blue 3	Third color picker / Level of blue	0-65535	10000
Alpha 3	Alpha 3	0-65535	65535

Softness 3	Softness 3	0-65535	0
Angle	Angle	0-360	180
Threshold	Threshold	0-65535	30000

▼ Gradient Triangle Black Lift



Allows turning the layer texture into a gradient with three different areas with the possibility of choosing 8 bit colors and alpha channels. Size, softness and rotation angle of the triangular (3-sided figure) are adjustable. The gradient colors are added to the layer texture but only to dark values. The higher the "Threshold" parameter the lighter the colors get that are influenced by the gradient colors.

This effect can be used for [blacklevel adjustment](#)<sup>613</sup>, when it is assigned to the output or to a layer that is toggled into the [Output Rendering Pass](#)<sup>297</sup> by using the [Layer Inspector](#)<sup>208</sup>.

Parameter	Description	Value Range	Default
Mix	Level of effect itself	0-255	0
Pt1 X	Horizontal position of the first point	0-65535	0
Pt1 Y	Vertical position of the first point	0-65535	0
Red 1	First color picker / Level of red	0-255	30
Green 1	First color picker / Level of green	0-255	30
Blue 1	First color picker / Level of blue	0-255	30
Alpha 1	Alpha 1	0-255	255
Softness 1	Softness 1	0-65535	0
Pt2 X	Horizontal position of the second point	0-65535	32768
Pt2 Y	Vertical position of the second point	0-65535	65535
Red 2	Second color picker / Level of red	0-255	30
Green 2	Second color picker / Level of green	0-255	30
Blue 2	Second color picker / Level of blue	0-255	30
Alpha 2	Alpha 2	0-255	255
Softness 2	Softness 2	0-65535	0
Pt3 X	Horizontal position of the third point	0-65535	65535
Pt3 Y	Vertical position of the third point	0-65535	0
Red 3	Third color picker / Level of red	0-255	30
Green 3	Third color picker / Level of green	0-255	30
Blue 3	Third color picker / Level of blue	0-255	30
Alpha 3	Alpha 3	0-255	255
Softness 3	Softness 3	0-65535	0
Angle	Angle	0-360	180
Threshold	Threshold	0-255	75



▼ Gradient Triangle



Allows turning the layer texture into a gradient with three different areas with the possibility of choosing 8 bit colors and alpha channels. Size, softness and rotation angle of the triangular (3-sided figure) are adjustable.

This effect can be used for [blacklevel adjustment](#)<sup>613</sup>, when it is assigned to the output or to a layer that is toggled into the [Output Rendering Pass](#)<sup>297</sup> by using the [Layer Inspector](#)<sup>208</sup>.

Parameter	Description	Value Range	Default
Mix	Level of effect itself	0-255	0
Pt1 X	Horizontal position of the first point	0-65535	0
Pt1 Y	Vertical position of the first point	0-65535	0
Red 1	First color picker / Level of red	0-255	255
Green 1	First color picker / Level of green	0-255	255
Blue 1	First color picker / Level of blue	0-255	255
Alpha 1	Alpha 1	0-255	255
Softness 1	Softness 1	0-65535	250
Pt2 X	Horizontal position of the second point	0-65535	32768
Pt2 Y	Vertical position of the second point	0-65535	65535
Red 2	Second color picker / Level of red	0-255	255
Green 2	Second color picker / Level of green	0-255	0
Blue 2	Second color picker / Level of blue	0-255	0
Alpha 2	Alpha 2	0-255	255
Softness 2	Softness 2	0-65535	250
Pt3 X	Horizontal position of the third point	0-65535	65535
Pt3 Y	Vertical position of the third point	0-65535	0
Red 3	Third color picker / Level of red	0-255	0
Green 3	Third color picker / Level of green	0-255	255
Blue 3	Third color picker / Level of blue	0-255	0
Alpha 3	Alpha 3	0-255	255
Softness 3	Softness 3	0-65535	250
Angle	Angle	0-360	180

### 5.4.2.11.23 IMAGE ADJUST

#### ▼ Brighten



Brighten simply shifts all pixel values higher or lower when adjusting the Brighten Factor. Technically, each RGB value is multiplied with a factor. In difference to the "[Gamma RGB](#)<sup>435</sup>" effect, this is a linear function.

Parameter	Description	Value Range	Default
Mix	Level of Effect	0-255	0
Factor	Factor of Brightness	0-255	32

#### ▼ Burn



The Burn Effect is used to lighten areas of the image. The Threshold parameter allows defining the intensity value of the pixels from which on Burn should take effect. Use the Factor parameter to set the amount of burning.

Parameter	Description	Value Range	Default
Mix	Level of Effect	0-255	0
Factor	Factor of Burning	0-255	32
Threshold	Threshold of intensity value	0-255	64

#### ▼ CCB Multiply



This is an alternative to the "[ColorContrastBrightness](#)"<sup>435</sup> effect. It allows adjusting Color, Contrast and Brightness.

The Chroma parameter itself works like the "Brighten" effect, it multiplies each RGB value with a factor. The Contrast parameter multiplies bright colors with a factor to make them brighter and divides dark colors with a factor to darken them further. The Brightness parameter does exactly the same as the Chroma parameter (in difference to the normal CCB FX).

Parameter	Description	Value Range	Default
Mix	Level of effect itself	0-255	0
Chroma	Chroma	0-255	128
Contrast	Contrast	0-255	128
Bright	Bright	0-255	128

▼ **ColorContrastBrightness**



The CCB Effect allows adjusting Color, Contrast and Brightness. The Chroma parameter itself works like the "Brighten" effect, it multiplies each RGB value with a factor. The Contrast parameter multiplies bright colors with a factor to make them brighter and divides dark colors with a factor to darken them further. The Brightness parameter adds a value to each RGB value equally.

Note, there is an alternative to this effect, the "[CCB Multiply](#)"<sup>434</sup>. There, the Brightness parameter works in the same way as the Chroma one.

Parameter	Description	Value Range	Default
Mix	Level of Effect	0-255	0
Chroma	Level of Chroma	0-255	128
Contrast	Level of Contrast	0-255	128
Brightness	Level of Brightness	0-255	128

▼ **Gamma RGB**



This shifts the RGB pixel values (individually or together) higher or lower to brighten or darken the image. when adjusting the Brighten Factor. Technically each RGB value is multiplied with a factor. In difference to the "[Brighten](#)"<sup>434</sup> effect, this gamma correction is a non-linear function.

Parameter	Description	Value Range	Default
Mix	Level of effect itself	0-255	0
Gamma R	Gamma R	0-65535	16384
Gamma G	Gamma G	0-65535	16384
Gamma B	Gamma B	0-65535	16384

▼ **HighMidLowLights**



Creates a lighting effect on the image, the colors for High, Mid and Low Lights can be adjusted separately.

Parameter	Description	Value Range	Default
Mix	Level of Effect	0-255	0
Red H	Level of Red for High Lights	0-255	128
Green H	Level of Green for High Lights		
Blue H	Level of Blue for High Lights		
Red M	Level of Red for Mid Lights	0-255	128
Green M	Level of Green for Mid Lights		
Blue M	Level of Blue for Mid Lights		
Red L	Level of Red for Low Lights		
Green L	Level of Green for Low Lights		
Blue L	Level of Blue for Low Lights	0-255	128

▼ **HSV Adjust**

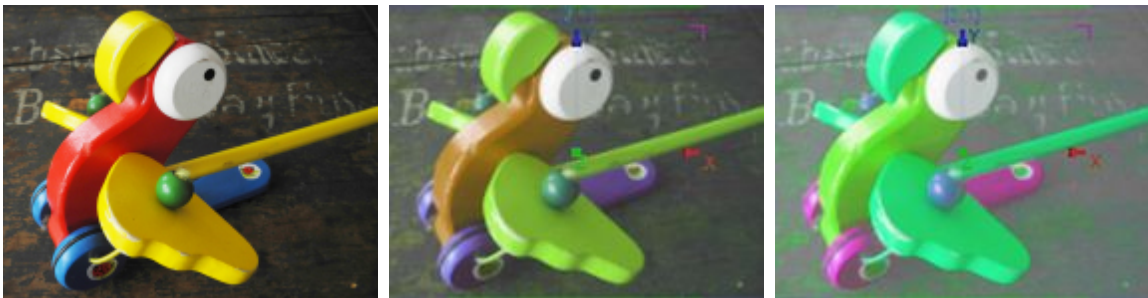

Changes the color of the image based on the HSV (hue, saturation, value) RGB color model, also called HSB (hue, saturation, brightness).

Changing the Hue in- or decreases all color hues in the image accordingly.  
 Changing the Saturation, in- or decreases the saturation (white to full color) of all colors in the image.  
 Changing the Value, in- or decreases the brightness value (black to full color) of all colors in the image.

Parameter	Description	Value Range	Default
Mix	Level of effect itself	0-255	0
Hue	Hue	0-255	128
Saturation	Saturation	0-255	128
Value	Value	0-255	128

▼ HSV by Hue



Changes the color of the image based on the HSV (hue, saturation, value) RGB color model, also called HSB (hue, saturation, brightness).  
 Pick a color / hue with color picker and set a threshold to influence neighboring colors.  
 The A Set of the following faders influences the chosen colors, the B set all other ones.

Changing the Hue in- or decreases the color hue of the color set.  
 Changing the Saturation, in- or decreases the saturation (white to full color) of the color set.  
 Changing the Value, in- or decreases the brightness value (black to full color) of the color set.

Parameter	Description	Value Range	Default
Mix	Level of effect itself	0-255	0
Red	Color picker / Level of red	0-255	0
Green	Color picker / Level of green	0-255	0
Blue	Color picker / Level of blue	0-255	0
Threshold	Threshold	0-255	32
Hue A	Hue A	0-255	128
Saturation A	Saturation A	0-255	128
Value A	Value A	0-255	128
Hue B	Hue B	0-255	128
Saturation B	Saturation B	0-255	128
Value B	Value B	0-255	128

▼ HSV-HS for V range



Changes the color of the image based on the HSV (hue, saturation, value) RGB color model, also called HSB (hue, saturation, brightness).

Pick a value (black to full color) and set the value range using the "Width" parameter. Note that a high width influences a small range and vice versa.

Changing the Hue in- or decreases the color hue for the value range.

Changing the Saturation, in- or decreases the saturation (white to full color) for the value range.

Parameter	Description	Value Range	Default
Mix	Level of effect itself	0-255	0
Value	Value	0-65535	32768
Width	Width	0-65535	8192
Hue	Hue	0-65535	32768
Saturation	Saturation	0-65535	32768

▼ Levels RGB



Allows setting the gradation levels for all three channels, RGB.

Parameter	Description	Value Range	Default
Mix	Level of Effect	0-255	0
Dark Red	Adjusting the dark limit for Red	0-255	0
Light Red	Adjusting the light limit for Red	0-255	255
Dark Green	Adjusting the dark limit for Green	0-255	0
Light Green	Adjusting the light limit for Green	0-255	255
Dark Blue	Adjusting the dark limit for Blue	0-255	0
Light Blue	Adjusting the light limit for Blue	0-255	255

▼ Levels



Allows setting the overall level gradation.

Parameter	Description	Value Range	Default
-----------	-------------	-------------	---------

Mix	Level of Effect	0-255	0
Dark	Adjusting the dark limit	0-255	0
Light	Adjusting the light limit	0-255	255

▼ **Posterize**



Posterize allows reducing the colour range by adjusting the amount of steps.

Parameter	Description	Value Range	Default
Mix	Level of Effect	0-255	0
Steps	Amount of steps	0-65535	4096

▼ **RGB Add**



Adds RGB colors by the RGB color mix value, allows inverting the image.

Parameter	Description	Value Range	Default
Mix	Level of Effect	0-255	0
Red	Red level, Color Picker	0-255	128
Green	Green level, Color Picker	0-255	128
Blue	Blue level, Color Picker	0-255	128
Invert	Inverts the RGB Levels	0-255	0

▼ **RGB Clipper**



Allows setting minimum and maximum levels for all three channels, RGB.

Parameter	Description	Value Range	Default
Mix	Level of Effect	0-255	0
Red Min	Min. level of Red	0-255	0
Red Max	Max. level of Red	0-255	255
Green Min	Min. level of Green	0-255	0
Green Max	Max. level of Green	0-255	255
Blue Min	Min. level of Blue	0-255	0
Blue Max	Max. level of Blue	0-255	255

▼ **RGB CTB**



RGB CTB (color temperature blue) emulates the CTB filter that converts tungsten light of 3200K to 'daylight' color.

Parameter	Description	Value Range	Default
Mix	Level of Effect	0-255	0
Amt	Amount of conversion into 'daylight' color	0-255	0



▼ RGB CTO



RGB CTO (color temperature orange) emulates the CTO filter that converts 'daylight' color to tungsten light of 3200K.

Parameter	Description	Value Range	Default
Mix	Level of Effect	0-255	0
Amt	Amount of conversion into tungsten light	0-255	0

▼ RGB Gamma



Allows adjusting the gamma for all three channels, RGB. The default value of 255 for RGB equates to a gamma value of 1.

Parameter	Description	Value Range	Default
Mix	Level of Effect	0-255	0
R	Gamma Red,	0-255	255
G	Gamma Green	0-255	255
B	Gamma Blue	0-255	255

▼ RGB Min Max



Allows setting minimum and maximum levels for all three channels, RGB.

Parameter	Description	Value Range	Default
Mix	Level of Effect	0-255	0
Red Min	Min. level of Red	0-255	128
Red Max	Max. level of Red	0-255	255
Green Min	Min. level of Green	0-255	128
Green Max	Max. level of Green	0-255	255
Blue Min	Min. level of Blue	0-255	128
Blue Max	Max. level of Blue	0-255	255

▼ **RGB Multiply**



All RGB colors are multiplied by RGB color mix values. Multiply can be factorized and inverted.

Parameter	Description	Value Range	Default
Mix	Level of Effect	0-255	0
Red	Red level, Color Picker	0-255	255
Green	Green level, Color Picker	0-255	255
Blue	Blue level, Color Picker	0-255	255
Factor	Color Multiply Factor	0-255	64
Invert	Inverts the multiplied RGB levels	0-255	0

▼ **RGB Squisher**



Squishes the RGB levels. For lower parameters this effect can be compared to the ["Levels RGB"](#)<sup>438</sup> effect.

Parameter	Description	Value Range	Default
Mix	Level of Effect	0-255	0
Red Min	Min. level of Red	0-255	128
Red Max	Max. level of Red	0-255	255
Green Min	Min. level of Green	0-255	128
Green Max	Max. level of Green	0-255	255

Blue Min	Min. level of Blue	0-255	128
Blue Max	Max. level of Blue	0-255	255

▼ **RGB to HSL**



Transforms the image from the RGB color space into the HSL color space.

Parameter	Description	Value Range	Default
Mix	Level of Effect	0-255	0

▼ **RGB to Video Colors 16-235**



Transforms the image colors from RGB (value range: 0 – 255) to Video Colors (range: 16-235).

Parameter	Description	Value Range	Default
Mix	Level of Effect	0-255	0

▼ **Video Colors 16-235 to RGB**



Transforms the image from Video Colors (range: 16-235) to RGB (value range: 0 – 255).

Parameter	Description	Value Range	Default
Mix	Level of Effect	0-255	0

▼ Video RGB CC



Changes the RGB values of the image. There is a "Lower" and a "Higher" fader for each Red, Green and Blue. The "Lower" fader subtracts the according color from all image colors. For the second image red was subtracted. The "Higher" fader increases the according color by multiplying it with a factor. For the last image red was enhanced.

Parameter	Description	Value Range	Default
Mix	Level of effect itself	0-255	0
R Lo	R Lo	0-255	18
R Hi	R Hi	0-255	43
G Lo	G Lo	0-255	18
G Hi	G Hi	0-255	43
B Lo	B Lo	0-255	18
B Hi	B Hi	0-255	43

▼ Video YUV to RGB



Converts the YUV colorspace (PAL / NTSC) to RGB color space.

Parameter	Description	Value Range	Default
Mix	Level of effect itself	0-255	0

### 5.4.2.11.24 IMAGE ADJUST - CROP

#### ▼ CCB Crop Edges (px)



Applies the effect within a rectangular area with hard borders; the rectangle's edges can be shifted in- or outwards independently.

The CCB Effect allows adjusting Color, Contrast and Brightness. The Chroma parameter multiplies each RGB value with a factor. The Contrast parameter multiplies bright colors with a factor to make them brighter and divides dark colors with a factor to darken them further. The Brightness parameter adds a value to each RGB value equally.

Note, there is an alternative to this effect, the "CCB Multiply". There, the Brightness parameter works in the same way as the Chroma one.

Parameter	Description	Value Range	Default
Mix	Level of effect itself	0-255	0
Chroma	Chroma	0-255	128
Contrast	Contrast	0-255	128
Bright	Bright	0-255	128
Left (px)	Left (px)	0-8192	0
Right (px)	Right (px)	0-8192	0
Top (px)	Top (px)	0-8192	0
Bottom (px)	Bottom (px)	0-8192	0

#### ▼ High Mid Low Crop Pixel



Applies the effect within a rectangular area with hard borders; the rectangle's edges can be shifted in- or outwards independently.

Creates a lighting effect on the image, the colors for High, Mid and Low Lights can be adjusted separately.

Parameter	Description	Value Range	Default
-----------	-------------	-------------	---------

Mix	Level of effect itself	0-255	0
Red H	Color picker / Level of red	0-255	128
Green H	Color picker / Level of green	0-255	128
Blue H	Color picker / Level of blue	0-255	128
Red M	Red M	0-255	128
Green M	Green M	0-255	128
Blue M	Blue M	0-255	128
Red L	Color picker / Level of red	0-255	128
Green L	Color picker / Level of green	0-255	128
Blue L	Color picker / Level of blue	0-255	128
Left (px)	Left (px)	0-8192	0
Right (px)	Right (px)	0-8192	0
Top (px)	Top (px)	0-8192	0
Bottom (px)	Bottom (px)	0-8192	0

▼ **Levels Crop Edges (px)**



Applies the effect within a rectangular area with hard borders; the rectangle's edges can be shifted in- or outwards independently.

Allows setting the overall level gradation.

Parameter	Description	Value Range	Default
Mix	Level of effect itself	0-255	0
Dark	Dark	0-255	0
Light	Light	0-255	255
Left (px)	Left (px)	0-8192	0
Right (px)	Right (px)	0-8192	0
Top (px)	Top (px)	0-8192	0
Bottom (px)	Bottom (px)	0-8192	0

▼ **Levels RGB Crop Edges (px)**

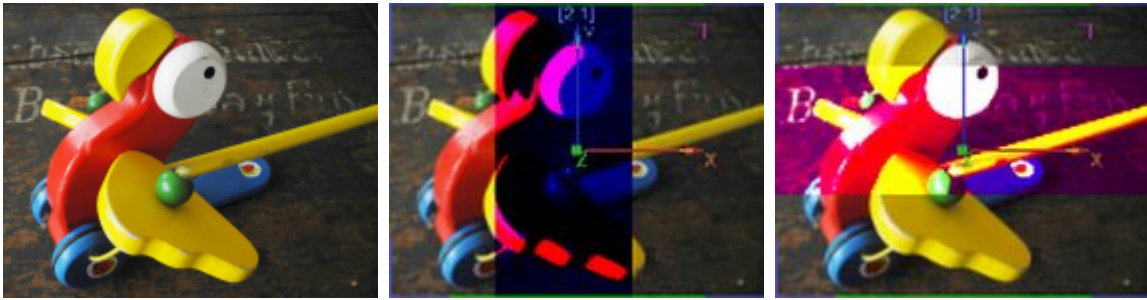

Applies the effect within a rectangular area with hard borders; the rectangle's edges can be shifted in- or outwards independently.

Allows setting the gradation levels for all three channels, RGB.

Parameter	Description	Value Range	Default
Mix	Level of effect itself	0-255	0
Dark Red	Dark Red	0-255	0
Light Red	Light Red	0-255	255
Dark Green	Dark Green	0-255	0
Light Green	Light Green	0-255	255
Dark Blue	Dark Blue	0-255	0
Light Blue	Light Blue	0-255	255
Left (px)	Left (px)	0-8192	0
Right (px)	Right (px)	0-8192	0
Top (px)	Top (px)	0-8192	0
Bottom (px)	Bottom (px)	0-8192	0

▼ **RGB Add Crop Edges (px)**

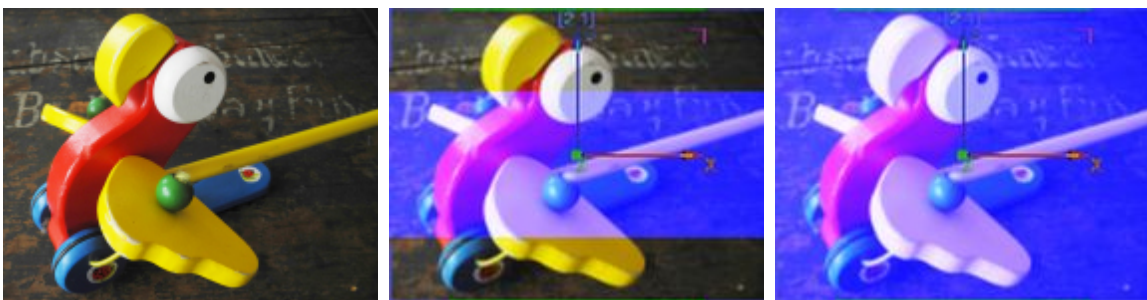

Applies the effect within a rectangular area with hard borders; the rectangle's edges can be shifted in- or outwards independently.

Adds RGB colors by the RGB color mix value, allows inverting the image.

Parameter	Description	Value Range	Default
Mix	Level of effect itself	0-255	0
Red	Color picker / Level of red	0-255	0
Green	Color picker / Level of green	0-255	0
Blue	Color picker / Level of blue	0-255	0

Invert	Inverts the RGB levels or the effect	0-255	0
Left (px)	Left (px)	0-8192	0
Right (px)	Right (px)	0-8192	0
Top (px)	Top (px)	0-8192	0
Bottom (px)	Bottom (px)	0-8192	0

▼ **RGB Clipper Crop Edges (px)**



Applies the effect within a rectangular area with hard borders; the rectangle's edges can be shifted in- or outwards independently.

Allows setting minimum and maximum levels for all three channels, RGB.

Parameter	Description	Value Range	Default
Mix	Level of effect itself	0-255	0
Red Min	Red Min	0-255	0
Red Max	Red Max	0-255	255
Green Min	Green Min	0-255	0
Green Max	Green Max	0-255	255
Blue Min	Blue Min	0-255	0
Blue Max	Blue Max	0-255	255
Left (px)	Left (px)	0-8192	0
Right (px)	Right (px)	0-8192	0
Top (px)	Top (px)	0-8192	0
Bottom (px)	Bottom (px)	0-8192	0

▼ **RGB CTB Crop Edges (px)**



Applies the effect within a rectangular area with hard borders; the rectangle's edges can be shifted in- or outwards independently.



RGB CTB (color temperature blue) emulates the CTB filter that converts tungsten light of 3200K to 'daylight' color.

Parameter	Description	Value Range	Default
Mix	Level of effect itself	0-255	0
Amount	Amount	0-255	0
Left (px)	Left (px)	0-8192	0
Right (px)	Right (px)	0-8192	0
Top (px)	Top (px)	0-8192	0
Bottom (px)	Bottom (px)	0-8192	0

▼ RGB CTO Crop Edges (px)

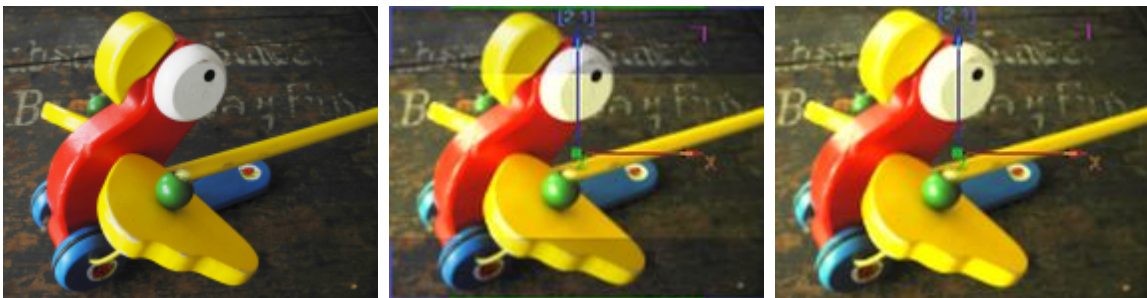

Applies the effect within a rectangular area with hard borders; the rectangle's edges can be shifted in- or outwards independently.

RGB CTO (color temperature orange) emulates the CTO filter that converts 'daylight' color to tungsten light of 3200K.

Parameter	Description	Value Range	Default
Mix	Level of effect itself	0-255	0
Amount	Amount	0-255	0
Left (px)	Left (px)	0-8192	0
Right (px)	Right (px)	0-8192	0
Top (px)	Top (px)	0-8192	0
Bottom (px)	Bottom (px)	0-8192	0

▼ RGB Gamma Crop Edges (px)

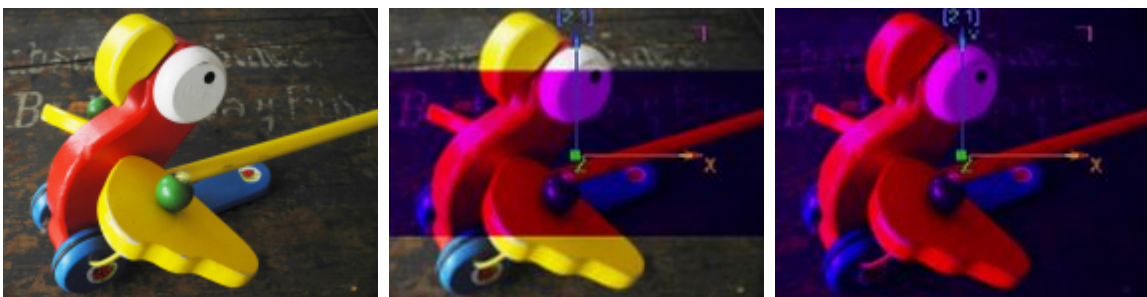

Applies the effect within a rectangular area with hard borders; the rectangle's edges can be shifted in- or outwards independently.

Allows adjusting the gamma for all three channels, RGB. The default value of 255 for RGB equates to a gamma value of 1.

Parameter	Description	Value Range	Default
Mix	Level of effect itself	0-255	0
R	Color picker / Level of red	0-255	255
G	Color picker / Level of green	0-255	255
B	Color picker / Level of blue	0-255	255
Left (px)	Left (px)	0-8192	0
Right (px)	Right (px)	0-8192	0
Top (px)	Top (px)	0-8192	0
Bottom (px)	Bottom (px)	0-8192	0

▼ **RGB Min Max Crop Edges (px)**

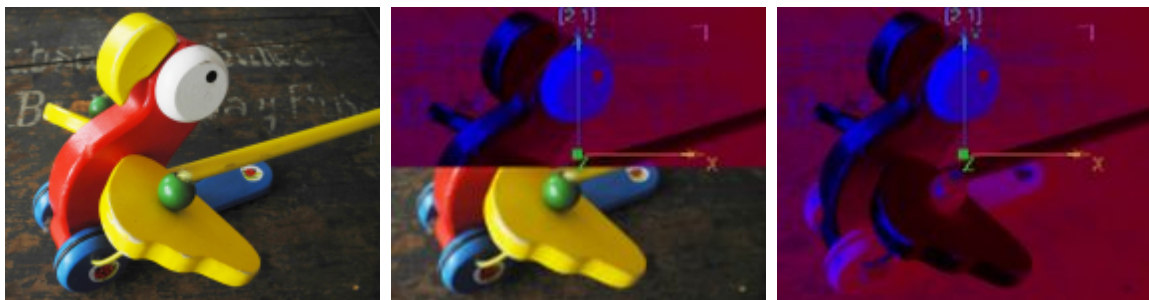

Applies the effect within a rectangular area with hard borders; the rectangle's edges can be shifted in- or outwards independently.

Allows setting minimum and maximum levels for all three channels, RGB.

Parameter	Description	Value Range	Default
Mix	Level of effect itself	0-255	0
Red Min	Red Min	0-255	128
Red Max	Red Max	0-255	255
Green Min	Green Min	0-255	128
Green Max	Green Max	0-255	255
Blue Min	Blue Min	0-255	128
Blue Max	Blue Max	0-255	255
Left (px)	Left (px)	0-8192	0
Right (px)	Right (px)	0-8192	0
Top (px)	Top (px)	0-8192	0
Bottom (px)	Bottom (px)	0-8192	0

▼ **RGB Multiply Crop Edges (px)**

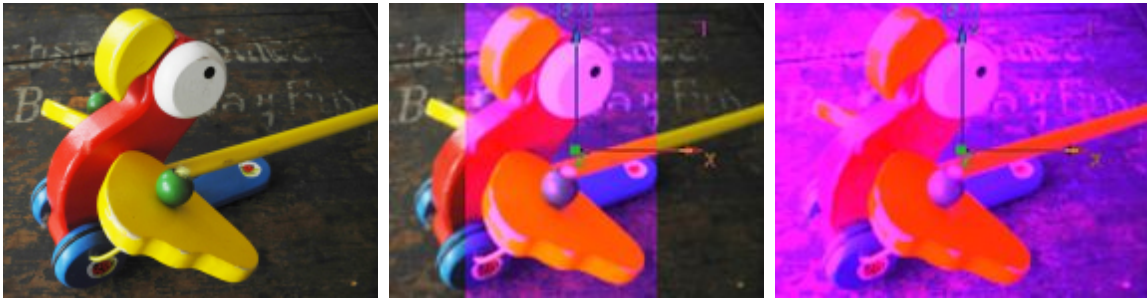

Applies the effect within a rectangular area with hard borders; the rectangle's edges can be shifted in- or outwards independently.

All RGB colors are multiplied by RGB color mix values. Multiply can be factorized and inverted.

Parameter	Description	Value Range	Default
Mix	Level of effect itself	0-255	0
Red	Color picker / Level of red	0-255	0
Green	Color picker / Level of green	0-255	0
Blue	Color picker / Level of blue	0-255	0
Factor	Factor	0-255	32
Invert	Inverts the RGB levels or the effect	0-255	0
Left (px)	Left (px)	0-8192	0
Right (px)	Right (px)	0-8192	0
Top (px)	Top (px)	0-8192	0
Bottom (px)	Bottom (px)	0-8192	0

▼ **RGB Squisher Crop Edges (px)**

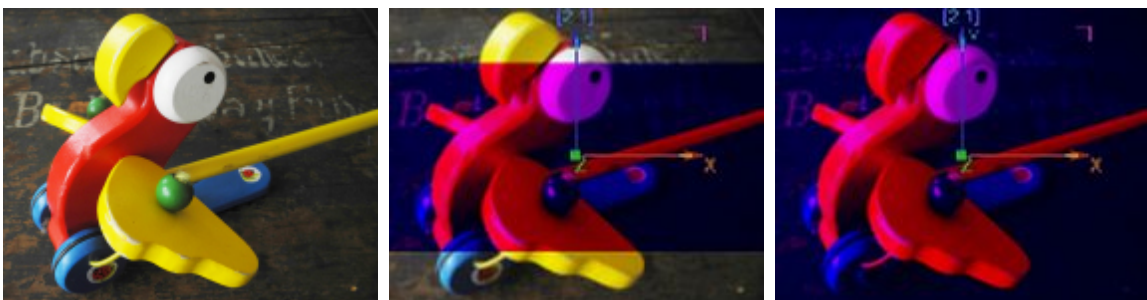

Applies the effect within a rectangular area with hard borders; the rectangle's edges can be shifted in- or outwards independently.

Squishes the RGB levels. For lower parameters this effect can be compared to the "[Levels RGB](#)"<sup>447</sup> effect.

Parameter	Description	Value Range	Default
Mix	Level of effect itself	0-255	0
Red Min	Red Min	0-255	0
Red Max	Red Max	0-255	255
Green Min	Green Min	0-255	0

Green Max	Green Max	0-255	255
Blue Min	Blue Min	0-255	0
Blue Max	Blue Max	0-255	255
Left (px)	Left (px)	0-8192	0
Right (px)	Right (px)	0-8192	0
Top (px)	Top (px)	0-8192	0
Bottom (px)	Bottom (px)	0-8192	0

**5.4.2.11.25 IMAGE ADJUST - IRIS**

▼ **CCB Iris**



Applies the effect within an elliptical area with a hard or soft border. Size, position and aspect of the ellipse are adjustable too, and the effect can be turned inside out.

The CCB Effect allows adjusting Color, Contrast and Brightness. The Chroma parameter multiplies each RGB value with a factor. The Contrast parameter multiplies bright colors with a factor to make them brighter and divides dark colors with a factor to darken them further. The Brightness parameter adds a value to each RGB value equally.

Note, there is an alternative to this effect, the "CCB Multiply". There, the Brightness parameter works in the same way as the Chroma one.

Parameter	Description	Value Range	Default
Mix	Level of effect itself	0-255	0
Chroma	Chroma	0-255	128
Contrast	Contrast	0-255	128
Bright	Bright	0-255	128
Size	Size	0-255	128
Softness	Softness	0-255	64
U	U	0-65535	32768
V	V	0-65535	32768
AspectIris	AspectIris	0-255	128
Invert	Inverts the RGB levels or the effect	0-255	0

▼ High Mid Low Iris



Applies the effect within an elliptical area with a hard or soft border. Size, position and aspect of the ellipse are adjustable too, and the effect can be turned inside out.

Creates a lighting effect on the image, the colors for High, Mid and Low Lights can be adjusted separately.

Parameter	Description	Value Range	Default
Mix	Level of effect itself	0-255	0
Red H	Color picker / Level of red	0-255	128
Green H	Color picker / Level of green	0-255	128
Blue H	Color picker / Level of blue	0-255	128
Red M	Red M	0-255	128
Green M	Green M	0-255	128
Blue M	Blue M	0-255	128
Red L	Color picker / Level of red	0-255	128
Green L	Color picker / Level of green	0-255	128
Blue L	Color picker / Level of blue	0-255	128
Size	Size	0-255	128
Softness	Softness	0-255	64
U	U	0-65535	32768
V	V	0-65535	32768
AspectIris	AspectIris	0-255	128
Invert	Inverts the RGB levels or the effect	0-255	0

▼ Levels Iris



Applies the effect within an elliptical area with a hard or soft border. Size, position and aspect of the ellipse are adjustable too, and the effect can be turned inside out.

Allows setting the overall level gradation.

Parameter	Description	Value Range	Default
Mix	Level of effect itself	0-255	0
Dark	Dark	0-255	0
Light	Light	0-255	255
Size	Size	0-255	128
Softness	Softness	0-255	64
U	U	0-65535	32768
V	V	0-65535	32768
AspectIris	AspectIris	0-255	128
Invert	Inverts the RGB levels or the effect	0-255	0

▼ Levels RGB Iris



Applies the effect within an elliptical area with a hard or soft border. Size, position and aspect of the ellipse are adjustable too, and the effect can be turned inside out.

Allows setting the gradation levels for all three channels, RGB.

Parameter	Description	Value Range	Default
Mix	Level of effect itself	0-255	0
Dark Red	Dark Red	0-255	0
Light Red	Light Red	0-255	255
Dark Green	Dark Green	0-255	0
Light Green	Light Green	0-255	255
Dark Blue	Dark Blue	0-255	0
Light Blue	Light Blue	0-255	255
Size	Size	0-255	128
Softness	Softness	0-255	64
U	U	0-65535	32768
V	V	0-65535	32768
AspectIris	AspectIris	0-255	128
Invert	Inverts the RGB levels or the effect	0-255	0

▼ RGB Add Iris



Applies the effect within an elliptical area with a hard or soft border. Size, position and aspect of the ellipse are adjustable too, and the effect can be turned inside out.

Adds RGB colors by the RGB color mix value, allows inverting the image.

Parameter	Description	Value Range	Default
Mix	Level of effect itself	0-255	0
Red	Color picker / Level of red	0-255	0
Green	Color picker / Level of green	0-255	0
Blue	Color picker / Level of blue	0-255	0
Invert	Inverts the RGB levels or the effect	0-255	0
Size	Size	0-255	128
Softness	Softness	0-255	64
U	U	0-65535	32768
V	V	0-65535	32768
AspectIris	AspectIris	0-255	128
Invert	Inverts the RGB levels or the effect	0-255	0

▼ RGB Clipper Iris



Applies the effect within an elliptical area with a hard or soft border. Size, position and aspect of the ellipse are adjustable too, and the effect can be turned inside out.

Allows setting minimum and maximum levels for all three channels, RGB.

Parameter	Description	Value Range	Default
Mix	Level of effect itself	0-255	0
Red Min	Red Min	0-255	0
Red Max	Red Max	0-255	255
Green Min	Green Min	0-255	0

Green Max	Green Max	0-255	255
Blue Min	Blue Min	0-255	0
Blue Max	Blue Max	0-255	255
Size	Size	0-255	128
Softness	Softness	0-255	64
U	U	0-65535	32768
V	V	0-65535	32768
AspectIris	AspectIris	0-255	128
Invert	Inverts the RGB levels or the effect	0-255	0

▼ RGB CTB Iris



Applies the effect within an elliptical area with a hard or soft border. Size, position and aspect of the ellipse are adjustable too, and the effect can be turned inside out.

RGB CTB (color temperature blue) emulates the CTB filter that converts tungsten light of 3200K to 'daylight' color.

Parameter	Description	Value Range	Default
Mix	Level of effect itself	0-255	0
Amount	Amount	0-255	0
Size	Size	0-255	128
Softness	Softness	0-255	64
U	U	0-65535	32768
V	V	0-65535	32768
AspectIris	AspectIris	0-255	128
Invert	Inverts the RGB levels or the effect	0-255	0

▼ RGB CTO Iris



Applies the effect within an elliptical area with a hard or soft border. Size, position and aspect of the ellipse are adjustable too, and the effect can be turned inside out.



RGB CTO (color temperature orange) emulates the CTO filter that converts 'daylight' color to tungsten light of 3200K.

Parameter	Description	Value Range	Default
Mix	Level of effect itself	0-255	0
Amount	Amount	0-255	0
Size	Size	0-255	128
Softness	Softness	0-255	64
U	U	0-65535	32768
V	V	0-65535	32768
AspectIris	AspectIris	0-255	128
Invert	Inverts the RGB levels or the effect	0-255	0

▼ **RGB Gamma Iris**

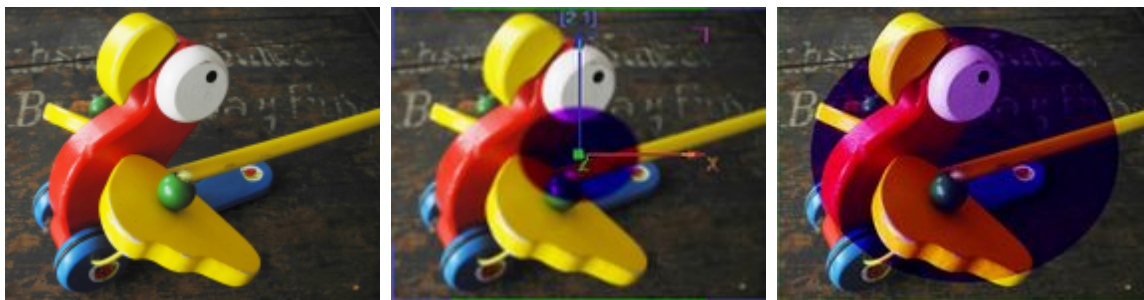

Applies the effect within an elliptical area with a hard or soft border. Size, position and aspect of the ellipse are adjustable too, and the effect can be turned inside out.

Allows adjusting the gamma for all three channels, RGB. The default value of 255 for RGB equates to a gamma value of 1.

Parameter	Description	Value Range	Default
Mix	Level of effect itself	0-255	0
R	Color picker / Level of red	0-255	255
G	Color picker / Level of green	0-255	255
B	Color picker / Level of blue	0-255	255
Size	Size	0-255	128
Softness	Softness	0-255	64
U	U	0-65535	32768
V	V	0-65535	32768
AspectIris	AspectIris	0-255	128
Invert	Inverts the RGB levels or the effect	0-255	0

▼ RGB Min Max Iris

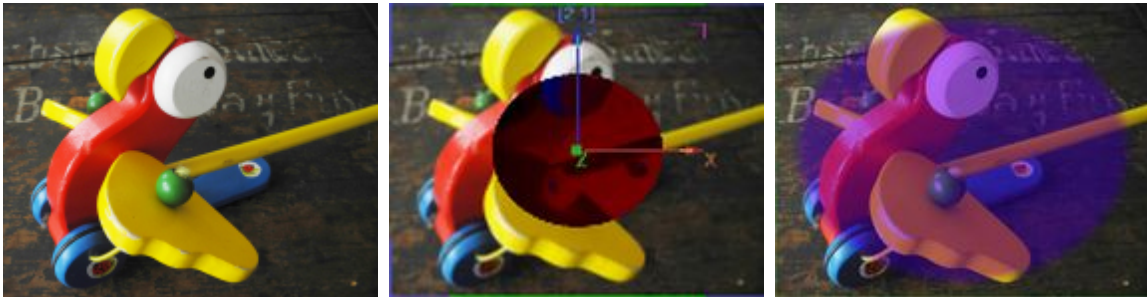

Applies the effect within an elliptical area with a hard or soft border. Size, position and aspect of the ellipse are adjustable too, and the effect can be turned inside out.

Allows setting minimum and maximum levels for all three channels, RGB.

Parameter	Description	Value Range	Default
Mix	Level of effect itself	0-255	0
Red Min	Red Min	0-255	128
Red Max	Red Max	0-255	255
Green Min	Green Min	0-255	128
Green Max	Green Max	0-255	255
Blue Min	Blue Min	0-255	128
Blue Max	Blue Max	0-255	255
Size	Size	0-255	128
Softness	Softness	0-255	64
U	U	0-65535	32768
V	V	0-65535	32768
AspectIris	AspectIris	0-255	128
Invert	Inverts the RGB levels or the effect	0-255	0

▼ RGB Multiply Iris



Applies the effect within an elliptical area with a hard or soft border. Size, position and aspect of the ellipse are adjustable too, and the effect can be turned inside out.

All RGB colors are multiplied by RGB color mix values. Multiply can be factorized and inverted.

Parameter	Description	Value Range	Default
Mix	Level of effect itself	0-255	0
Red	Color picker / Level of red	0-255	0

Green	Color picker / Level of green	0-255	0
Blue	Color picker / Level of blue	0-255	0
Factor	Factor	0-255	32
Size	Size	0-255	128
Softness	Softness	0-255	64
U	U	0-65535	32768
V	V	0-65535	32768
AspectIris	AspectIris	0-255	128
Invert	Inverts the RGB levels or the effect	0-255	0

▼ **RGB Squisher Iris**

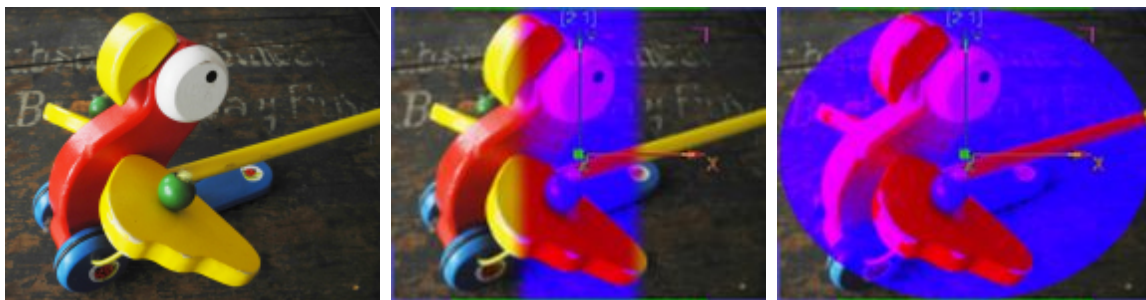

Applies the effect within an elliptical area with a hard or soft border. Size, position and aspect of the ellipse are adjustable too, and the effect can be turned inside out.

Squishes the RGB levels. For lower parameters this effect can be compared to the ["Levels RGB"](#) <sup>454</sup> effect.

Parameter	Description	Value Range	Default
Mix	Level of effect itself	0-255	0
Red Min	Red Min	0-255	0
Red Max	Red Max	0-255	255
Green Min	Green Min	0-255	0
Green Max	Green Max	0-255	255
Blue Min	Blue Min	0-255	0
Blue Max	Blue Max	0-255	255
Size	Size	0-255	128
Softness	Softness	0-255	64
U	U	0-65535	32768
V	V	0-65535	32768
AspectIris	AspectIris	0-255	128
Invert	Inverts the RGB levels or the effect	0-255	0

### 5.4.2.11.26 IMAGE ADJUST - MEDIAMASK

#### ▼ CCB MediaMask



Applies the effect according to a mask. White areas in the mask apply the effect fully. Less brighter areas reduce the effect accordingly.

The CCB Effect allows adjusting Color, Contrast and Brightness. The Chroma parameter multiplies each RGB value with a factor. The Contrast parameter multiplies bright colors with a factor to make them brighter and divides dark colors with a factor to darken them further. The Brightness parameter adds a value to each RGB value equally.

Note, there is an alternative to this effect, the "CCB Multiply". There, the Brightness parameter works in the same way as the Chroma one.

Parameter	Description	Value Range	Default
Mix	Level of effect itself	0-255	0
Chroma	Chroma	0-255	128
Contrast	Contrast	0-255	128
Bright	Bright	0-255	128
Media	Media file as source for overlay or mask	-	-

#### ▼ High Mid Low MediaMask



Applies the effect according to a mask. White areas in the mask apply the effect fully. Less brighter areas reduce the effect accordingly.

Creates a lighting effect on the image, the colors for High, Mid and Low Lights can be adjusted separately.

Parameter	Description	Value Range	Default
Mix	Level of effect itself	0-255	0
Red H	Color picker / Level of red	0-255	128
Green H	Color picker / Level of green	0-255	128

Blue H	Color picker / Level of blue	0-255	128
Red M	Red M	0-255	128
Green M	Green M	0-255	128
Blue M	Blue M	0-255	128
Red L	Color picker / Level of red	0-255	128
Green L	Color picker / Level of green	0-255	128
Blue L	Color picker / Level of blue	0-255	128
Media	Media file as source for overlay or mask	-	-

▼ Levels MediaMask



Applies the effect according to a mask. White areas in the mask apply the effect fully. Less brighter areas reduce the effect accordingly.

Allows setting the overall level gradation.

Parameter	Description	Value Range	Default
Mix	Level of effect itself	0-255	0
Dark	Dark	0-255	0
Light	Light	0-255	255
Media	Media file as source for overlay or mask	-	-

▼ Levels RGB MediaMask



Applies the effect according to a mask. White areas in the mask apply the effect fully. Less brighter areas reduce the effect accordingly.

Allows setting the gradation levels for all three channels, RGB.

Parameter	Description	Value Range	Default
Mix	Level of effect itself	0-255	0

Dark Red	Dark Red	0-255	0
Light Red	Light Red	0-255	255
Dark Green	Dark Green	0-255	0
Light Green	Light Green	0-255	255
Dark Blue	Dark Blue	0-255	0
Light Blue	Light Blue	0-255	255
Media	Media file as source for overlay or mask	-	-

▼ **RGB Add MediaMask**



Applies the effect according to a mask. White areas in the mask apply the effect fully. Less brighter areas reduce the effect accordingly.

Adds RGB colors by the RGB color mix value, allows inverting the image.

Parameter	Description	Value Range	Default
Mix	Level of effect itself	0-255	0
Red	Color picker / Level of red	0-255	0
Green	Color picker / Level of green	0-255	0
Blue	Color picker / Level of blue	0-255	0
Invert	Inverts the RGB levels or the effect	0-255	0
Media	Media file as source for overlay or mask	-	-

▼ **RGB Clipper MediaMask**



Applies the effect according to a mask. White areas in the mask apply the effect fully. Less brighter areas reduce the effect accordingly.

RGB CTB (color temperature blue) emulates the CTB filter that converts tungsten light of 3200K to 'daylight' color.

Parameter	Description	Value Range	Default
Mix	Level of effect itself	0-255	0
Red Min	Red Min	0-255	0
Red Max	Red Max	0-255	255
Green Min	Green Min	0-255	0
Green Max	Green Max	0-255	255
Blue Min	Blue Min	0-255	0
Blue Max	Blue Max	0-255	255
Media	Media file as source for overlay or mask	-	-

▼ **RGB CTB MediaMask**



Applies the effect according to a mask. White areas in the mask apply the effect fully. Less brighter areas reduce the effect accordingly.

Allows adjusting the gamma for all three channels, RGB. The default value of 255 for RGB equates to a gamma value of 1.

Parameter	Description	Value Range	Default
Mix	Level of effect itself	0-255	0
Amount	Amount	0-255	0
Media	Media file as source for overlay or mask	-	-

▼ **RGB CTO MediaMask**



Applies the effect according to a mask. White areas in the mask apply the effect fully. Less brighter areas reduce the effect accordingly.

RGB CTO (color temperature orange) emulates the CTO filter that converts 'daylight' color to tungsten light of 3200K.

Parameter	Description	Value Range	Default
-----------	-------------	-------------	---------

Mix	Level of effect itself	0-255	0
Amount	Amount	0-255	0
Media	Media file as source for overlay or mask	-	-

▼ **RGB Gamma MediaMask**



Applies the effect according to a mask. White areas in the mask apply the effect fully. Less brighter areas reduce the effect accordingly.

Allows adjusting the gamma for all three channels, RGB. The default value of 255 for RGB equates to a gamma value of 1.

Parameter	Description	Value Range	Default
Mix	Level of effect itself	0-255	0
R	Color picker / Level of red	0-255	255
G	Color picker / Level of green	0-255	255
B	Color picker / Level of blue	0-255	255
Media	Media file as source for overlay or mask	-	-

▼ **RGB Min Max MediaMask**



Applies the effect according to a mask. White areas in the mask apply the effect fully. Less brighter areas reduce the effect accordingly.

Allows setting minimum and maximum levels for all three channels, RGB.

Parameter	Description	Value Range	Default
Mix	Level of effect itself	0-255	0
Red Min	Red Min	0-255	128
Red Max	Red Max	0-255	255
Green Min	Green Min	0-255	128



Green Max	Green Max	0-255	255
Blue Min	Blue Min	0-255	128
Blue Max	Blue Max	0-255	255
Media	Media file as source for overlay or mask	-	-

▼ **RGB Multiply MediaMask**



Applies the effect according to a mask. White areas in the mask apply the effect fully. Less brighter areas reduce the effect accordingly.

All RGB colors are multiplied by RGB color mix values. Multiply can be factorized and inverted.

Parameter	Description	Value Range	Default
Mix	Level of effect itself	0-255	0
Red	Color picker / Level of red	0-255	0
Green	Color picker / Level of green	0-255	0
Blue	Color picker / Level of blue	0-255	0
Factor	Factor	0-255	32
Invert	Inverts the RGB levels or the effect	0-255	0
Media	Media file as source for overlay or mask	-	-

▼ **RGB Squisher MediaMask**



Applies the effect according to a mask. White areas in the mask apply the effect fully. Less brighter areas reduce the effect accordingly.

Squishes the RGB levels. For lower parameters this effect can be compared to the "[Levels RGB](#)"<sup>461</sup> effect.

Parameter	Description	Value Range	Default
Mix	Level of effect itself	0-255	0

Red Min	Red Min	0-255	0
Red Max	Red Max	0-255	255
Green Min	Green Min	0-255	0
Green Max	Green Max	0-255	255
Blue Min	Blue Min	0-255	0
Blue Max	Blue Max	0-255	255
Media	Media file as source for overlay or mask	-	-

### 5.4.2.11.27 IMAGE ADJUST - SOFTBORDER

#### ▼ CCB Softborder



Applies the effect within within an adjustable rectangular area with soft edges.

The CCB Effect allows adjusting Color, Contrast and Brightness. The Chroma parameter multiplies each RGB value with a factor. The Contrast parameter multiplies bright colors with a factor to make them brighter and divides dark colors with a factor to darken them further. The Brightness parameter adds a value to each RGB value equally.

Note, there is an alternative to this effect, the "CCB Multiply". There, the Brightness parameter works in the same way as the Chroma one.

Parameter	Description	Value Range	Default
Mix	Level of effect itself	0-255	0
Chroma	Chroma	0-255	128
Contrast	Contrast	0-255	128
Bright	Bright	0-255	128
Size	Size	0-255	16
Corner	Corner	0-255	0

#### ▼ High Mid Low Softborder



Applies the effect within within an adjustable rectangular area with soft edges.

Creates a lighting effect on the image, the colors for High, Mid and Low Lights can be adjusted separately.

Parameter	Description	Value Range	Default
Mix	Level of effect itself	0-255	0
Red H	Color picker / Level of red	0-255	128
Green H	Color picker / Level of green	0-255	128
Blue H	Color picker / Level of blue	0-255	128
Red M	Red M	0-255	128
Green M	Green M	0-255	128
Blue M	Blue M	0-255	128
Red L	Color picker / Level of red	0-255	128
Green L	Color picker / Level of green	0-255	128
Blue L	Color picker / Level of blue	0-255	128
Size	Size	0-255	16
Corner	Corner	0-255	0

▼ **Levels RGB Softborder**



Applies the effect within within an adjustable rectangular area with soft edges.

Allows setting the overall level gradation.

Parameter	Description	Value Range	Default
Mix	Level of effect itself	0-255	0
Dark Red	Dark Red	0-255	0
Light Red	Light Red	0-255	255
Dark Green	Dark Green	0-255	0
Light Green	Light Green	0-255	255
Dark Blue	Dark Blue	0-255	0
Light Blue	Light Blue	0-255	255
Size	Size	0-255	16
Corner	Corner	0-255	0

▼ Levels Softborder



Applies the effect within within an adjustable rectangular area with soft edges.

Allows setting the gradation levels for all three channels, RGB.

Parameter	Description	Value Range	Default
Mix	Level of effect itself	0-255	0
Dark	Dark	0-255	0
Light	Light	0-255	255
Size	Size	0-255	16
Corner	Corner	0-255	0

▼ RGB Add Softborder



Applies the effect within within an adjustable rectangular area with soft edges.

Adds RGB colors by the RGB color mix value, allows inverting the image.

Parameter	Description	Value Range	Default
Mix	Level of effect itself	0-255	0
Red	Color picker / Level of red	0-255	0
Green	Color picker / Level of green	0-255	0
Blue	Color picker / Level of blue	0-255	0
Invert	Inverts the RGB levels or the effect	0-255	0
Size	Size	0-255	16
Corner	Corner	0-255	0

▼ **RGB Clipper Softborder**



Applies the effect within within an adjustable rectangular area with soft edges.

Allows setting minimum and maximum levels for all three channels, RGB.

Parameter	Description	Value Range	Default
Mix	Level of effect itself	0-255	0
Red Min	Red Min	0-255	0
Red Max	Red Max	0-255	255
Green Min	Green Min	0-255	0
Green Max	Green Max	0-255	255
Blue Min	Blue Min	0-255	0
Blue Max	Blue Max	0-255	255
Size	Size	0-255	16
Corner	Corner	0-255	0

▼ **RGB CTB Softborder**



Applies the effect within within an adjustable rectangular area with soft edges.

RGB CTB (color temperature blue) emulates the CTB filter that converts tungsten light of 3200K to 'daylight' color.

Parameter	Description	Value Range	Default
Mix	Level of effect itself	0-255	0
Amount	Amount	0-255	0
Size	Size	0-255	16
Corner	Corner	0-255	0

▼ RGB CTO Softborder



Applies the effect within within an adjustable rectangular area with soft edges.

RGB CTO (color temperature orange) emulates the CTO filter that converts 'daylight' color to tungsten light of 3200K.

Parameter	Description	Value Range	Default
Mix	Level of effect itself	0-255	0
Amount	Amount	0-255	0
Size	Size	0-255	16
Corner	Corner	0-255	0

▼ RGB Gamma Softborder

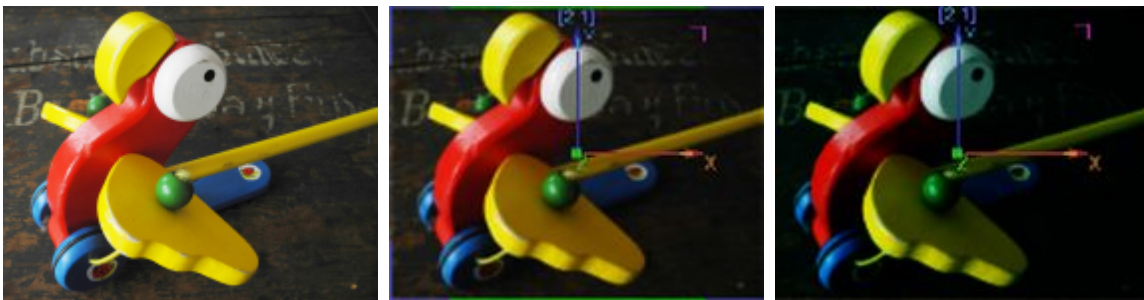

Applies the effect within within an adjustable rectangular area with soft edges.

Allows adjusting the gamma for all three channels, RGB. The default value of 255 for RGB equates to a gamma value of 1.

Parameter	Description	Value Range	Default
Mix	Level of effect itself	0-255	0
R	Color picker / Level of red	0-255	255
G	Color picker / Level of green	0-255	255
B	Color picker / Level of blue	0-255	255
Size	Size	0-255	16
Corner	Corner	0-255	0

▼ **RGB Min Max Softborder**



Applies the effect within within an adjustable rectangular area with soft edges.

Allows setting minimum and maximum levels for all three channels, RGB.

Parameter	Description	Value Range	Default
Mix	Level of effect itself	0-255	0
Red Min	Red Min	0-255	128
Red Max	Red Max	0-255	255
Green Min	Green Min	0-255	128
Green Max	Green Max	0-255	255
Blue Min	Blue Min	0-255	128
Blue Max	Blue Max	0-255	255
Size	Size	0-255	16
Corner	Corner	0-255	0

▼ **RGB Multiply Softborder**



Applies the effect within within an adjustable rectangular area with soft edges.

All RGB colors are multiplied by RGB color mix values. Multiply can be factorized and inverted.

Parameter	Description	Value Range	Default
Mix	Level of effect itself	0-255	0
Red	Color picker / Level of red	0-255	0
Green	Color picker / Level of green	0-255	0
Blue	Color picker / Level of blue	0-255	0
Factor	Factor	0-255	32
Invert	Inverts the RGB levels or the effect	0-255	0
Size	Size	0-255	16
Corner	Corner	0-255	0

▼ RGB Squisher Softborder



Applies the effect within within an adjustable rectangular area with soft edges.

Squishes the RGB levels. For lower parameters this effect can be compared to the ["Levels RGB"](#)<sup>467</sup> effect.

Parameter	Description	Value Range	Default
Mix	Level of effect itself	0-255	0
Red Min	Red Min	0-255	0
Red Max	Red Max	0-255	255
Green Min	Green Min	0-255	0
Green Max	Green Max	0-255	255
Blue Min	Blue Min	0-255	0
Blue Max	Blue Max	0-255	255
Size	Size	0-255	16
Corner	Corner	0-255	0

5.4.2.11.28 KEYING

▼ Alpha Adjust

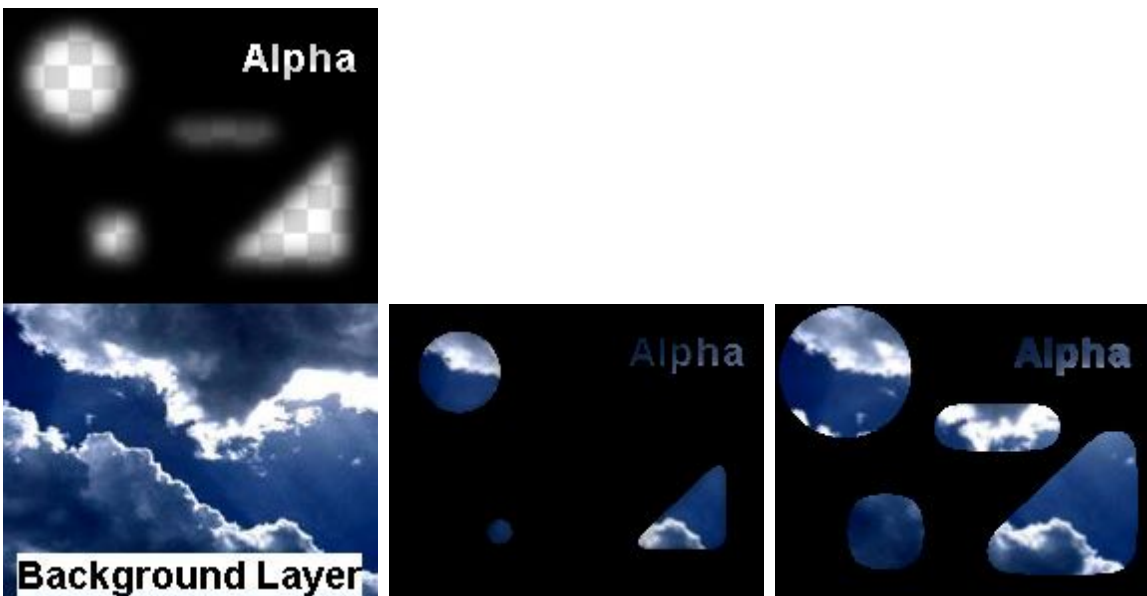



This effect influences the threshold between transparent (see-through) and opaque pixels. You can either enlarge or reduce the transparent area when it has a soft border with partly transparent pixels.

Parameter	Description	Value Range	Default
Mix	Level of effect itself	0-255	0
Low	Low	0-255	0
High	High	0-255	255

▼ **Black Key Mask**



Allows keying out black parts of the image based on the luminance values, all other parts will be masked black. This result can be inverted: transparent areas get black. In order to key out only black with the possibility not to get any transparency for other dark parts, use RGB key instead.

Parameter	Description	Value Range	Default
Mix	Level of Effect	0-255	0
Range	Range of color tolerance	0-255	255
Invert	Inverts the Black Key Mask	0-255	0

▼ **Black Key**



Allows keying out black parts of the image based on the luminance values. This result can be inverted: transparent areas get black. In order to key out only black with the possibility not to get any transparency for other light parts, use RGB key instead.

Parameter	Description	Value Range	Default
Mix	Level of Effect	0-255	0
Range	Range of color tolerance	0-255	255
Invert	Inverts the black key	0-255	0

▼ Difference Key Mask



This effect looks for pixels that match in the textures from the layer media and effect media. Corresponding areas are keyed out, meaning that the background layer is visible. When there are differences in areas, they are not keyed out but overlap the background as a black mask. You can adjust a threshold to accept small color differences. The third image shows the result of the "Invert" parameter: differences are keyed out and matching areas overlay the background in their original color (and white if transparent).

Parameter	Description	Value Range	Default
Mix	Level of Effect	0-255	0
Threshold	Threshold	0-255	0
Media	Media File as Mask	0-255	255
Invert	Inverts the difference key	0-255	0

▼ Difference Key

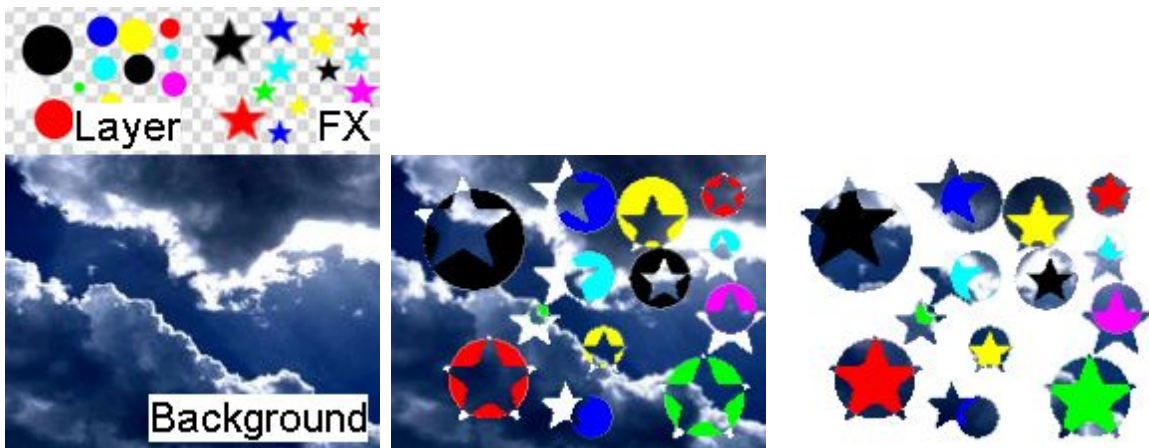

This effect looks for pixels that match in the textures from the layer media and effect media. Corresponding areas are keyed out, meaning that the background layer is visible. When there are differences in areas, they are not keyed out but overlap the background in the color from the layer media. You can adjust a threshold to accept small color differences. The third image shows the result of the "Invert" parameter: differences are keyed out and matching areas overlay the background in their original color (and white if transparent).

Parameter	Description	Value Range	Default
-----------	-------------	-------------	---------

Mix	Level of Effect	0-255	0
Threshold	Threshold	0-255	0
Media	Media File as Mask	0-255	255
Invert	Inverts the difference key	0-255	0

▼ **Difference Matte**

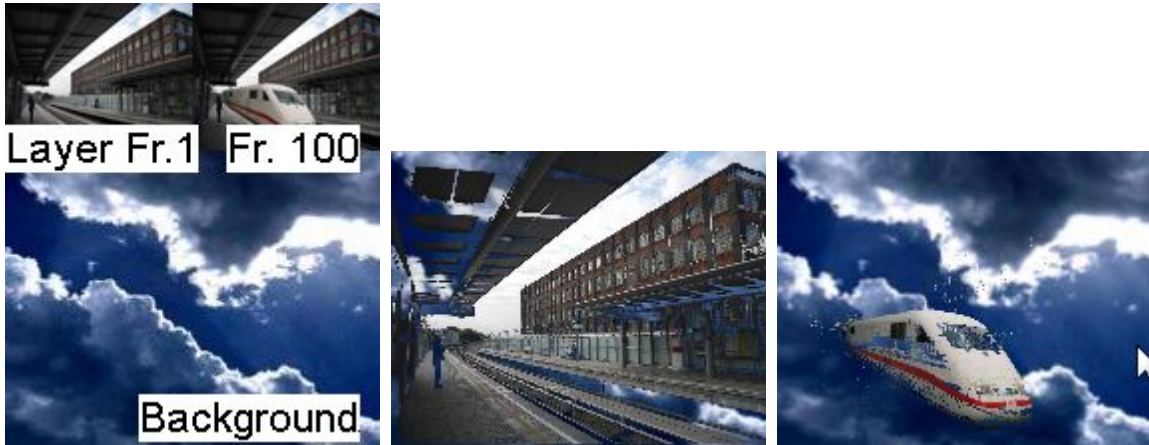

This effect creates a mask from a captured frame and keys out all matching pixels from following frames in the video applied to the layer. As seen in the second image, all black pixels from the layer texture are keyed out in general. To capture a frame toggle the "Capture" parameter above 0 and back to 0. Now this frame is memorized and compared to following frames. All matching pixels are keyed out, different pixels overlap the background. The third image shows a train, which was not visible in the captured frame, hence it can be seen on top the background layer.

Parameter	Description	Value Range	Default
Mix	Level of effect itself	0-255	0
Capture	Capture	0-255	0
Threshold	Threshold	0-255	64

▼ **Luma Key**

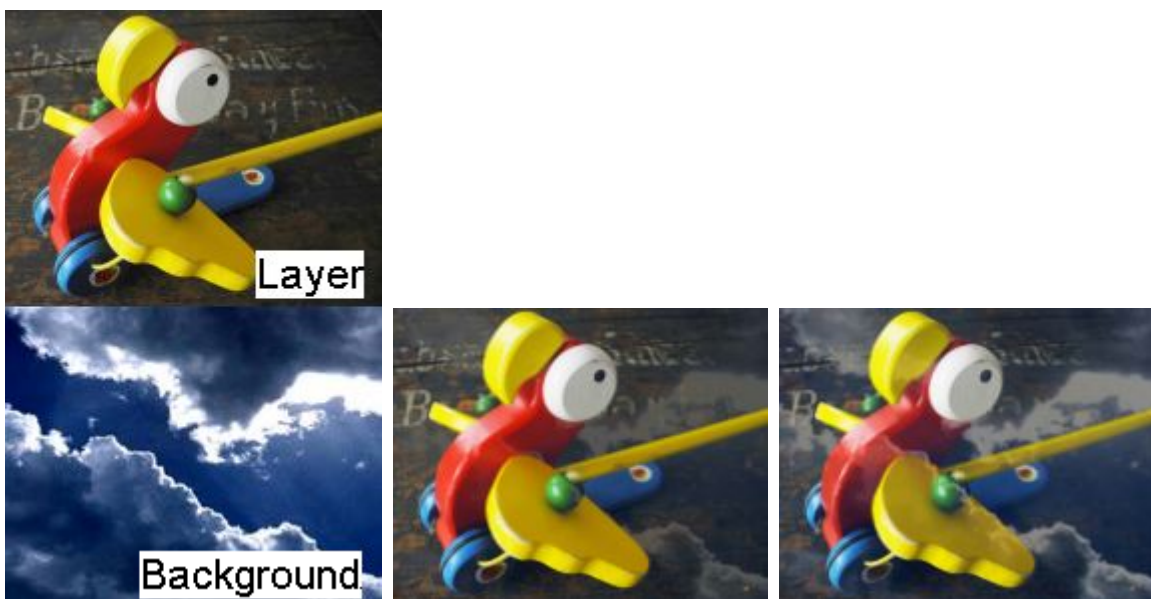

Allows adjusting a key based on luminance (brightness) values. A high range starts keying out, only dark colors (see second image) whilst a smaller level enlarges the value range of affected pixel brightness (see third image).

Parameter	Description	Value Range	Default
Mix	Level of Effect	0-255	0
Range	Range	0-255	255
Level	Level	0-255	255
Invert	Inverts the luma key	0-255	0

▼ RGB Key Factor Mask



Allows keying out any RGB color included in the picked Color Range. In the second image a bright yellow color (RGB 255,255,0) and a small range was chosen which means that most dark colors, dark red, dark green and yellow tones are keyed out and the background can be seen there. All other pixels are rendered as a black mask. In the third image, the result was inverted.

Parameter	Description	Value Range	Default
Mix	Level of Effect	0-255	0
Range	Range	0-255	128
Red	Red level, Color picker	0-255	0
Green	Green level, Color picker	0-255	0
Blue	Blue level, Color picker	0-255	0
Invert	Inverts the RGB key factor mask	0-255	0

▼ RGB Key Factor

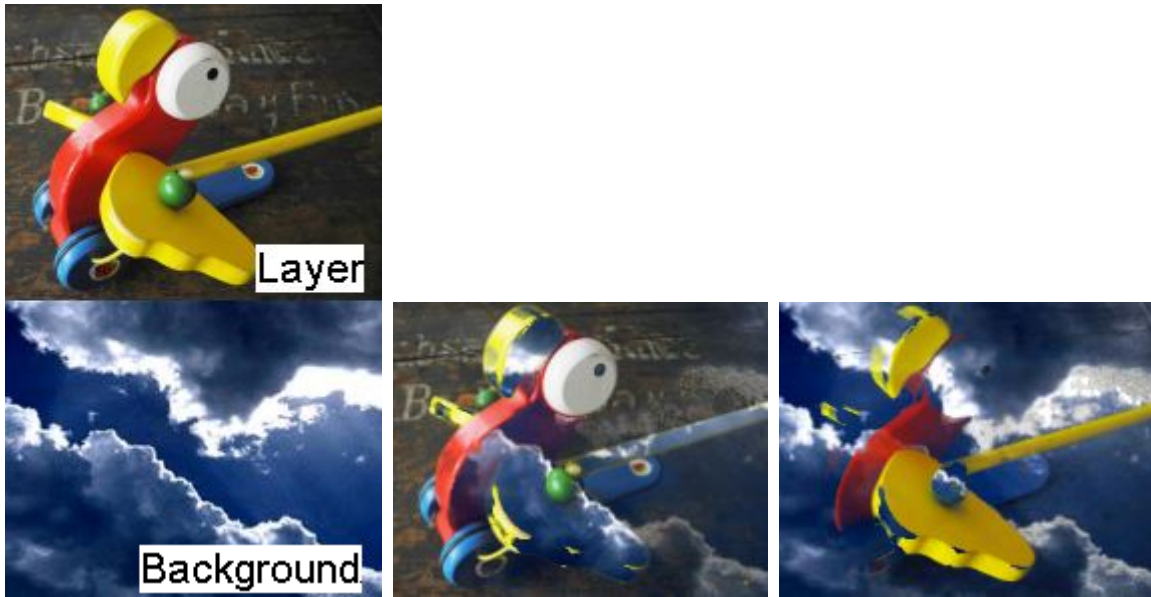

Allows keying out any RGB color included in the picked Color Range. In the second image a bright yellow color (RGB 255,255,0) and a small range was chosen which means that most dark colors, dark red, dark green and yellow tones are keyed out and the background can be seen there. In the third image, the result was inverted.

Parameter	Description	Value Range	Default
Mix	Level of Effect	0-255	0
Range	Range	0-255	128
Red	Red level, Color picker	0-255	0
Green	Green level, Color picker	0-255	0
Blue	Blue level, Color picker	0-255	0
Invert	Inverts the RGB key factor mask	0-255	0

▼ RGB Key Mask



Allows keying out any RGB color by adjusting the Color Range, Threshold, Radius. In the second image a yellow color was chosen which means that all yellow parts from the layer texture are keyed out and the background can be seen there whilst all other pixels are rendered as a black mask. In the third image, the result was inverted.

Parameter	Description	Value Range	Default
Mix	Level of Effect	0-255	0
Range	Range	0-255	128
Red	Red level, Color picker	0-255	0
Green	Green level, Color picker	0-255	0
Blue	Blue level, Color picker	0-255	0
Invert	Inverts the RGB key factor mask	0-255	0

▼ RGB Key

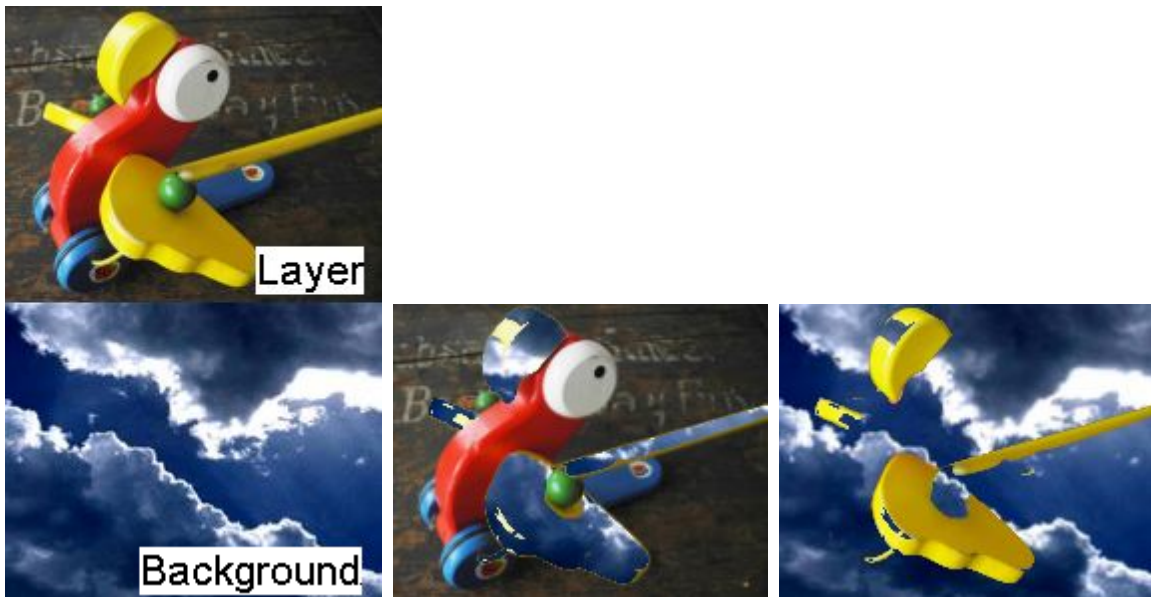

Allows keying out any RGB color by adjusting the Color Range, Threshold, Radius. In the second image a yellow color was chosen which means that all yellow parts from the layer texture are keyed out and the background can be seen there. In the third image, the result was inverted.

Parameter	Description	Value Range	Default
Mix	Level of Effect	0-255	0
Range	Range	0-255	128
Red	Red level, Color picker	0-255	0
Green	Green level, Color picker	0-255	0
Blue	Blue level, Color picker	0-255	0
Threshold	Threshold	0-255	64
Radius	Radius	0-255	32
Invert	Inverts the RGB key factor mask	0-255	0

▼ **Spill Reduce Blue AVG**

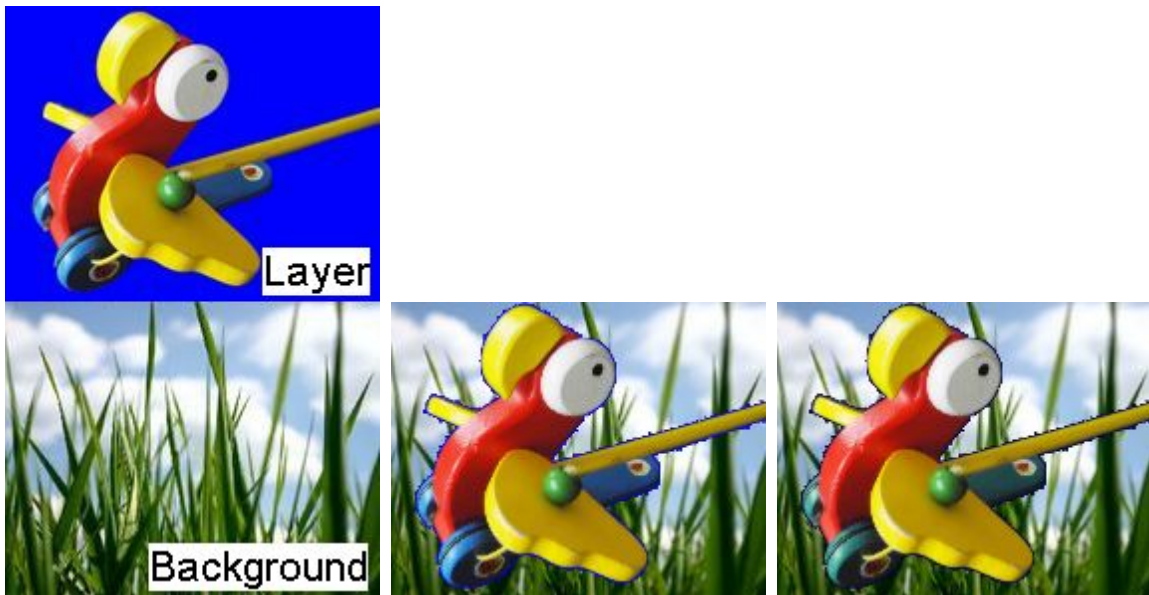

This effect is useful in blue screen applications. After keying out the blue color, e.g. with an "[RGB key](#)<sup>479</sup>" effect, sometimes there is a blue spill left (very light or dark blue pixels), which is depicted in the second image. This Spill Reduce effect reduces the blue value in all colors but affects colors with a red or green value less. In other words, pure blue colors are darkened fully (RGB 0,0,255 > 0,0,0) whilst yellow, cyan and purple change less (RGB r,g,255 > r,g,128) and red and green stay unchanged. The intensity of the reducing accords to the value of the Mix parameter (Mix 0>255). Note that depending on the colors of the cut out object, another blue spill effect might give better results, or more RGB keys set to light and dark blue.

Parameter	Description	Value Range	Default
Mix	Level of effect itself	0-255	0

▼ **Spill Reduce Blue by Green**

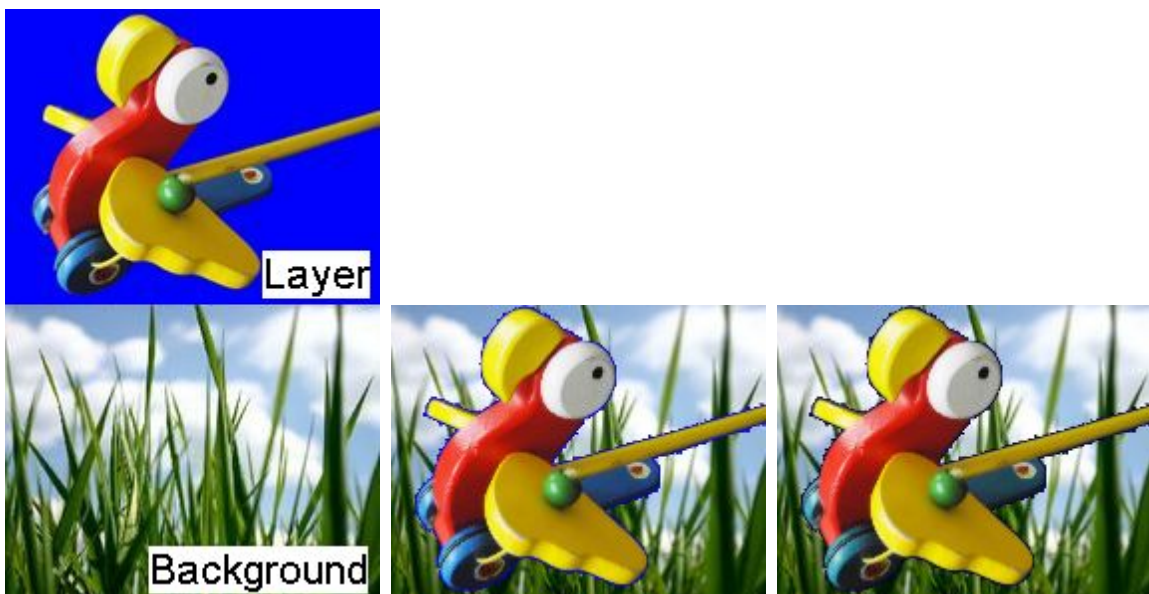



This effect is useful in blue screen applications. After keying out the blue color, e.g. with an "RGB key<sup>479</sup>" effect, sometimes there is a blue spill left (very light or dark blue pixels), which is depicted in the second image. This Spill Reduce effect reduces the blue value in all colors without a green value. In other words, blue colors are darkened (RGB 0,255,0 > 0,0,0) and purple colors turn red (RGB 255,0,255 > 255,0,0) whilst red, green, yellow and cyan stay unchanged. The intensity of the reducing accords to the value of the Mix parameter (Mix 0>255). Note that depending on the colors of the cut out object, another blue spill effect might give better results, or more RGB keys set to light and dark blue.

Parameter	Description	Value Range	Default
Mix	Level of effect itself	0-255	0

▼ Spill Reduce Blue

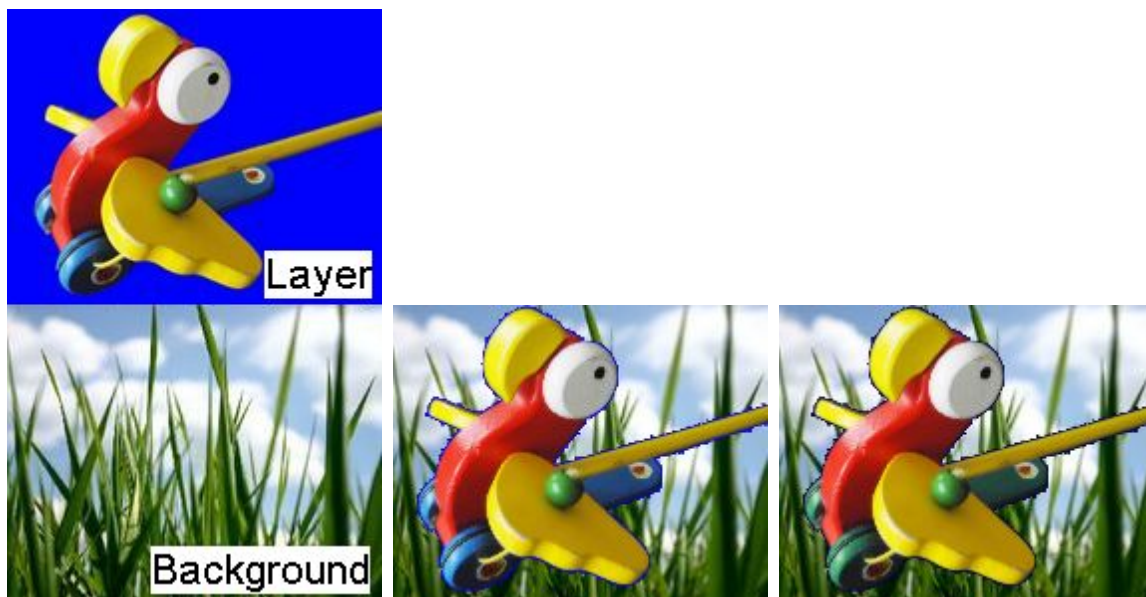

This effect is useful in blue screen applications. After keying out the blue color, e.g. with an "RGB key<sup>479</sup>" effect, sometimes there is a blue spill left (very light or dark blue pixels), which is depicted in the second image. This Spill Reduce effect reduces the blue value in all colors without a red value. In other words, blue colors are darkened (RGB 0,0,255 > 0,0,0) and cyan colors turn green (RGB 0,255,255 > 0,255,0) whilst red, green, yellow and purple stay unchanged. The intensity of the reducing accords to the value of the Mix parameter (Mix 0>255). Note that depending on the colors of the cut out object, another blue spill effect might give better results, or alternatively more RGB keys set to light and dark blue.

Parameter	Description	Value Range	Default
Mix	Level of effect itself	0-255	0

▼ Spill Reduce Green AVG

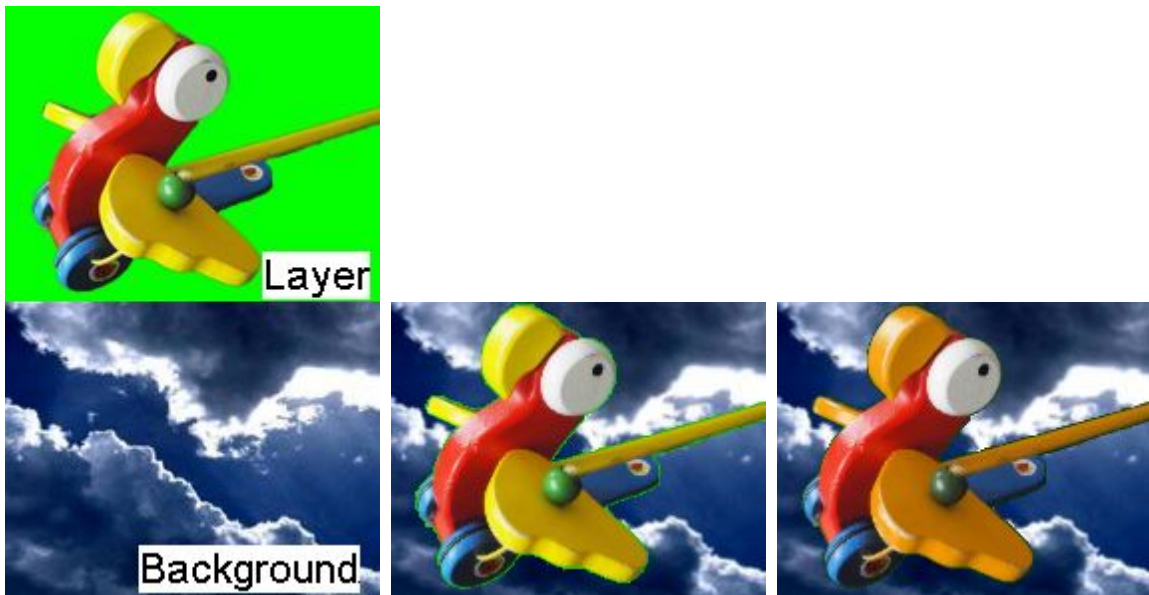

This effect is useful in green screen applications. After keying out the green color, e.g. with an "[RGB key](#)<sup>479</sup>" effect, sometimes there is a green spill left (very light or dark green pixels), which is depicted in the second image. This Spill Reduce effect reduces the green value in all colors but affects colors with a blue or red value less. In other words, pure green colors are darkened fully (RGB 0,255,0 > 0,0,0) whilst yellow, cyan and purple change less (RGB r,255,b > r,128,b) and red and blue stay unchanged. The intensity of the reducing accords to the value of the Mix parameter (Mix 0>255). Note that depending on the colors of the cut out object, another green spill effect might give better results, or more RGB keys set to light and dark green.

Parameter	Description	Value Range	Default
Mix	Level of effect itself	0-255	0

▼ Spill Reduce Green by Blue

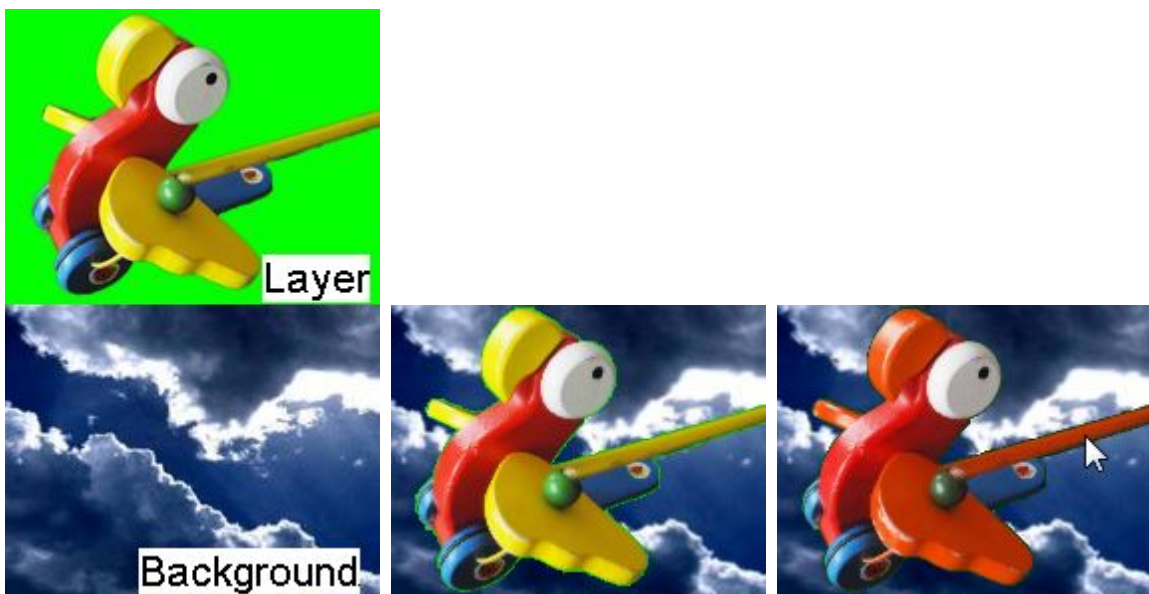

This effect is useful in green screen applications. After keying out the green color, e.g. with an "RGB key<sup>479</sup>" effect, sometimes there is a green spill left (very light or dark green pixels), which is depicted in the second image. This Spill Reduce effect reduces the green value in all colors without a blue value. In other words, green colors are darkened (RGB 0,255,0 > 0,0,0) and yellow colors turn red (RGB 255,255,0 > 255,0,0) whilst red, blue, cyan and purple stay unchanged. The intensity of the reducing accords to the value of the Mix parameter (Mix 0>255). Note that depending on the colors of the cut out object, another green spill effect might give better results, or more RGB keys set to light and dark green.

Parameter	Description	Value Range	Default
Mix	Level of effect itself	0-255	0

▼ Spill Reduce Green

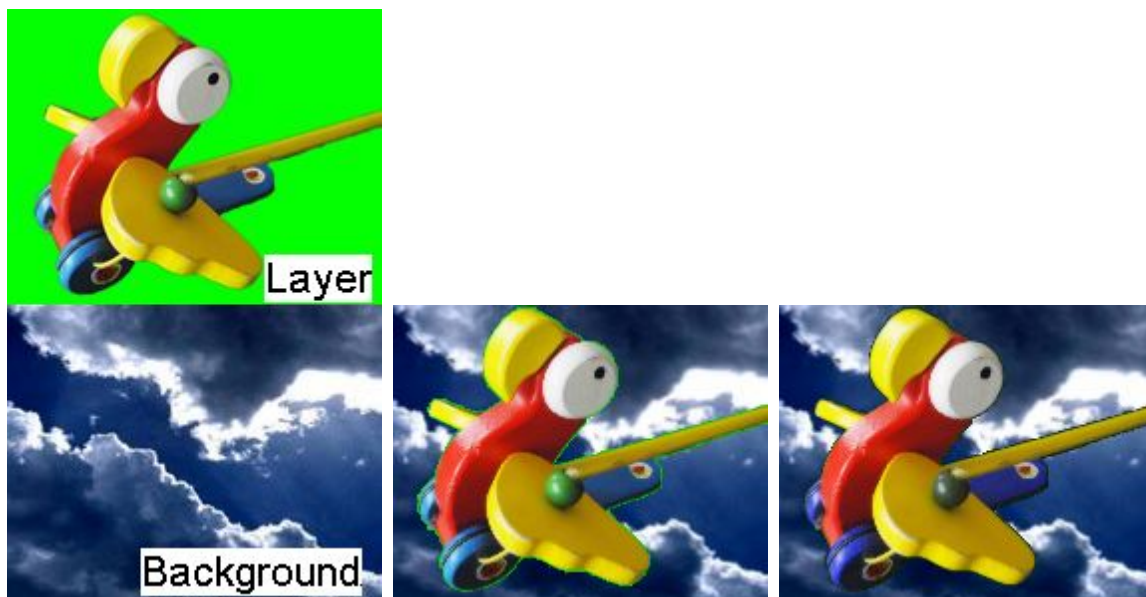

This effect is useful in green screen applications. After keying out the green color, e.g. with an "RGB key<sup>479</sup>" effect, sometimes there is a green spill left (very light or dark green pixels), which is depicted in the second image. This Spill Reduce effect reduces the green value in all colors without a red value. In other words, green colors are darkened (RGB 0,255,0 > 0,0,0) and cyan colors turn blue (RGB 0,255,255 > 0,0,255) whilst red, blue, yellow and purple stay unchanged. The intensity of the reducing accords to the value of the Mix parameter (Mix 0>255). Note that depending on the colors of the cut out object, another green spill effect might give better results, or alternatively more RGB keys set to light and dark green.

Parameter	Description	Value Range	Default
Mix	Level of effect itself	0-255	0

▼ **White Key Mask**



Allows keying out white parts of the image based on the luminance values, all other parts will be masked black. This result can be inverted: transparent areas get black. In order to key out only white with the possibility not to get any transparency for other light parts, use RGB key instead.

Parameter	Description	Value Range	Default
Mix	Level of Effect	0-255	0
Range	Range of color tolerance	0-255	255
Invert	Inverts the white key	0-255	0

▼ **White Key**



Allows keying out white parts of the image based on the luminance values. This result can be inverted: transparent areas get white. In order to key out only white with the possibility not to get any transparency for other light parts, use RGB key instead.

Parameter	Description	Value Range	Default
Mix	Level of Effect	0-255	0
Range	Range of color tolerance	0-255	255
Invert	Inverts the white key	0-255	0

**5.4.2.11.29 LIGHTING**

▼ **++ General information for Light Effects ++**

The light feature in Pandoras Box can be best understood and used when the following fundamental course of events is kept in mind:

1. Firstly, light is emitted by a light source. Here the light rays are determined in their starting position, direction, intensity and color.

A light source can be either the inherent light from the [Lighting effect](#)<sup>[491]</sup>, or in all other cases, an external light from a [Light Layer](#)<sup>[582]</sup>.

2. The light then shines on an object's (i.e. layer's) surface. The object's properties, also called its material, determine how the light interacts with it and in which direction and what amount and color it bounces off.

Note that in Pandoras Box light cannot pass through objects or bend around them, it can only be reflected.

3. Lastly, the reflected light enters the viewpoint. In the real world it would be the human eye whilst here, it is the virtual camera. No adjustments can be made at this point of the sequence. It is now, when the object becomes truly visible, its image is rendered.

Same as incident light, reflected light has no attenuation, which means that their intensity is not a function of the distance but is always equally intense.

Light falling on an object holds a source color; in physical terms it has a specific wavelength, in rendering terms it has an rgb value. The rgb value depends additionally on the light intensity. The default color is white - consisting of red, green and blue components in equal amounts. When interacting with the object's material the source color changes according to the target color which is determined by the layer texture's color. The color of the reflected light is the common intersection of the source and target color.

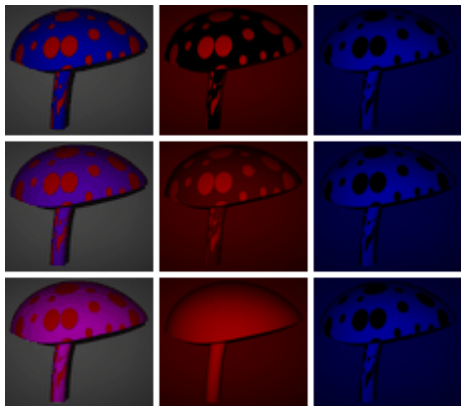

In all images seen left, the background is pure white, but the opacity is lowered to 33% thus the reflected light's intensity is reduced.

The mushrooms texture is always covered with red spots; the main color is

- blue with `rgb = 0,0,255` in image 1-3,
- purple with `rgb = 125,0,255` in image 4-6 and
- magenta with `rgb = 255,0,255` in image 7-9.

The light changes from left to right:

- white with `rgb = 255,255,255`
- red with `rgb = 255,0,0`

- blue with `rgb = 0,0,255`.

But materials in the real world do not only reflect in one color, rather with many shades and nuances. In an effort to mimic this, more than one light is used to describe an virtual object's reflection. In Pandoras Box (PB), three varieties of light have an effect: ambient, diffuse and specular light. Unlike the first two, reflected specular color does not necessarily need to be modulated by the objects color. In particular, materials like plastic often reflect only the source's color whilst metallic materials might reflect with a shifted hue.

Another difference between the three lights is in which direction they reflect from a surface. The left image below shows the first law of reflection theory, considering a perfectly smooth surface. The perpendicular surface normal divides the angle between incident light rays and their reflection equally. In other words, the angle of incidence equals the angle of reflection.

The surface normal is an imaginary line, perpendicular to the surface. If a layer has no mesh or a flat one, the entire object has parallel surface normals.

Apart from that, the polygons forming the mesh determine the direction of each line and consequently the direction of reflected light.

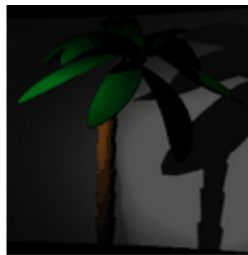
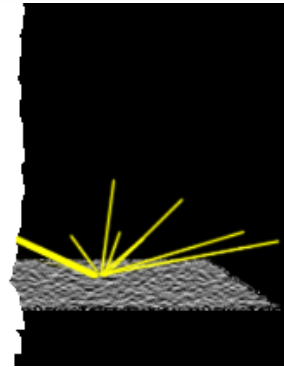
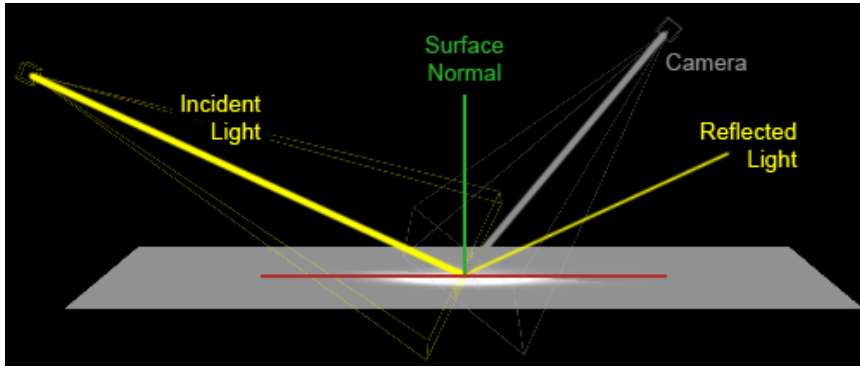

To imitate a rough surface one could apply a mesh with disarranged polygons. However it is far easier to achieve it with a material's attribute. This is what diffuse reflection does. Diffuse light is reflected in all direction (see right upper principle depiction). The larger the angle between light source and surface normal gets, the less intense is the reflection. As a result diffuse light points the dimension of the object out and enhances surface details.



Typically, an object with an high proportion of diffusion appears to have a rough surface such as wood or rock. For the left images a light source was first positioned to the right, then to the left.



In opposite, the specular level influences how many light rays bounce off coherently / parallel. This is what creates highlights on an object's surface and makes it appear to have a smooth surface such as plastic or metal. The smoother a surface is, the smaller and sharper the highlights are. This last adjustment is done in PB with the smoothness parameter. Just as diffuse reflection, specular reflection depends on the relative position and orientation of light source and target. But as the rays are not reflected in all directions any more, the position of the camera plays an important role too. It influences how intense the highlight shines.

The third light variation that is added to the illumination term is ambient light. Other than the above mentioned, ambient light is absolutely directionless. It illuminates all surfaces equally regardless their orientation. Strictly speaking, it has no true counterpart in real-world but still it gives very good results when it comes to simulate global light e.g. sun light and all the light reflected from the surrounding environment.

The image sequence below illustrates how the ambient component with a level of 40, the diffuse component with a level of 200 and the specular component with a level of 180 (with its softness set to 60) add up and result in a realistic shaded plastic palm tree.



Please note:

The effects described below are NOT designed to be applied more than once to a layer. If you want a layer to be lit by two light source please use the according effect.

▼ 1 Light Mat-Spec-Color



Allows receiving light emitted by a [Light Layer](#)<sup>582</sup> by right-clicking on the Media parameter and choosing "Share Layer Texture". Adjustments can be made influencing the reflection of the light in order to imitate a specific material e.g. wood or plastic. In addition highlights caused by specular light can be tinted. In the images, the light itself was not changed! The left image has no light turned on.

Parameter	Description	Value Range	Default
Mix	Level of Effect	0-255	0
Mode	None (0), Cast & Receive (1) Cast (2)	0-2	0
Media	Media File as Mask	0-255	255
Ambient	Proportion of Ambient Light	0-255	25
Diffuse	Proportion of Diffuse Light	0-255	255
Specular	Proportion of Specular Light	0-255	50
Softness	Softness of highlights (= reflection of Specular Light)	0-255	10
Spec Red	Red level of reflection of Specular Light	0-255	255
Spec Green	Green level of reflection of Specular Light	0-255	255
Spec Blue	Blue level of reflection of Specular Light	0-255	255

▼ 1 Light Shadow Catcher



Allows using a layer as a shadow layer. This is of interest for Virtual Reality applications as this only renders shadows from (multiple, virtual) 3D objects on to one layer, which then can be used as an overlay layer for a Studio set.

The left image depicts the scene. A layer with a color bar image lies between a background cloud image and a 3D globe which is illuminated by a light using the ["1 Light"](#)<sup>489</sup> effect.

For the second image, the "1 Light Shadow Catcher" FX on the color bars is switched on and assigned with the same light as the globe is. The "Blend" parameter is turned to 255.

For the right image the parameter "Blend" is turned to 0 and a purple color is chosen to overwrite the color bar texture with a solid color.



Note, for this effect, the light texture should be a solid white or transparent one!

Parameter	Description	Value Range	Default
Mix	Level of effect itself	0-255	0
Mode	Mode	-	-
Light 1	Light 1	-	-
Blend	Blend	0-255	0
Red	Color picker / Level of red	0-255	0
Green	Color picker / Level of green	0-255	0
Blue	Color picker / Level of blue	0-255	0

▼ **1 Light**



Allows receiving light emitted by a [Light Layer](#)<sup>582</sup> by right-clicking on the Media parameter and choosing "Share Layer Texture". Adjustments can be made that influence the reflection of the light in order to imitate a specific material e.g wood or plastic. In the images, the light itself was not changed! The left image has no light turned on.

Parameter	Description	Value Range	Default
Mix	Level of Effect	0-255	0
Mode	None (0), Cast & Receive (1) Cast (2)	0-2	0
Media	Media File as Mask	0-255	255
Ambient	Proportion of Ambient Light	0-255	25
Diffuse	Proportion of Diffuse Light	0-255	255
Specular	Proportion of Specular Light	0-255	50
Softness	Softness of highlights (= reflection of Specular Light)	0-255	10

▼ **2 Lights Mat-Spec-Color**

see FX [1 Light Mat-Spec-Color](#)<sup>488</sup>. Here, the effect layer may be influenced by two different light sources.

▼ **2 Lights Texture Projection Adaptive**

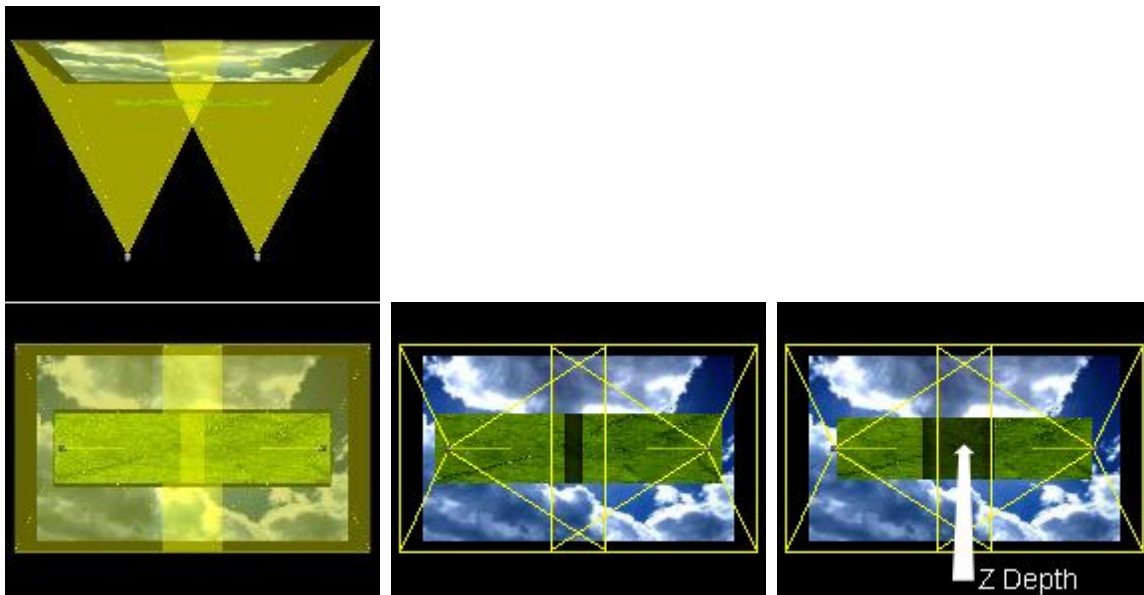

Allows adaptive softedge applications. When two projectors project onto a screen that moves towards and away from them, the size of the overlapping area changes. It increases with the distance between projectors and screen. Hence, the softedge parameters must adapt to the new screen position. An adaptive softedge can be programmed using this effect (on the screen layer). The FX subtracts the light amount from 2 [Light Layers](#)<sup>582</sup>, it darkens the overlap area which compensates for the higher light amount from the real projectors. For this setup a 3D setup is mandatory, i.e. the PB light sources (as well as PB cameras) have the same parameters (position, FOV etc.) as the real projectors and the PB screen layer corresponds with the real screen.

The left image depicts the scene. A green layer moves in front of a cloud image. The light overlap on the background image is larger than on the green image as its nearer to the lights. For the right image the green layer was moved further away from the lights / projectors, enlarging the overlap, the area that PB now renders automatically darker.

Parameter	Description	Value Range	Default
Mix	Level of effect itself	0-255	0
Amt	Amt	0-255	255
Light 1	Light 1	-	-
Light 2	Light 2	-	-

▼ **2 Lights**

see FX [1 Light](#)<sup>489</sup>. Here, the effect layer may be influenced by two different light sources.

▼ **3 Lights Mat-Spec-Color**

see FX [1 Light Mat-Spec-Color](#)<sup>488</sup>. Here, the effect layer may be influenced by three different light sources.

▼ **3 Lights**

see FX [1 Light](#)<sup>489</sup>. Here, the effect layer may be influenced by three different light sources.

▼ **Light Texture Projection**

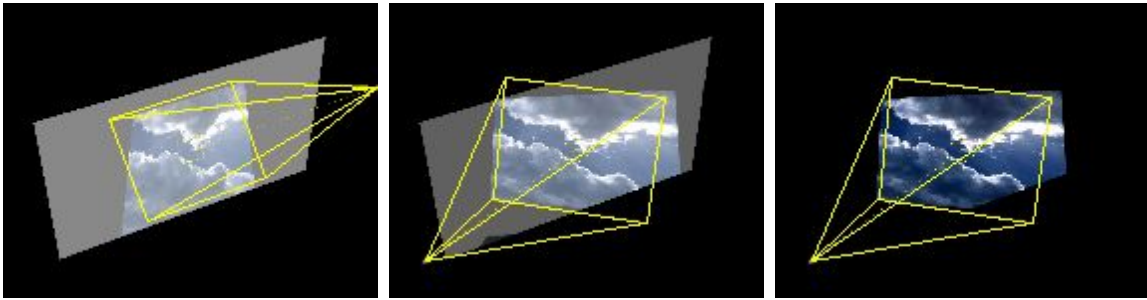

This is a "[1 Light](#)"<sup>489</sup> effect that is reduced to the parameters "Mix" and "Light 1". Right-click on the Media field and choose "Share Layer Texture" to receiving its light. This effect is ideal if you simply like to render a light texture on another layer to simulate a projected image.

The left image depicts the scene. The [Light Layer](#)<sup>582</sup> projects a cloud image onto a white layer with the FX's Mix parameter at 125. For the second image the Light Layer changed the position resulting in a different angle for the projection. The right image depicts the same position but with a Mix parameter at 255, making the white texture invisible when no light is received.

Note that the effect "[Texture Projection](#)"<sup>492</sup> might also be of interest.

Parameter	Description	Value Range	Default
Mix	Level of effect itself	0-255	0
Light 1	Light 1	-	-

▼ **Lighting**



Allows setting an own light source that can influence only the effect layer itself. The layer's reflection behavior can be adapted to match a specific material. The inherent light source can be adjusted in its position. Other than the Light Layer this light source has no direction, it is rather a point light. In the images, the light's position has changed as well as the material properties. The left image has no light turned on.

Parameter	Description	Value Range	Default
Mix	Level of Effect	0-255	0
Softness	Softness of highlights (= reflection of Specular Light)	0-255	16
Ambient	Proportion of Ambient Light	0-255	128
Diffuse	Proportion of Diffuse Light	0-255	16
Specular	Proportion of Specular Light	0-255	255
Light X Pos	X Position of light source; equals a layer X position of + / - 50.000	0-65535	32768

Light Y Pos	Y Position of light source; equals a layer Y position of + / - 50.000	0-65535	32768
Light Z Pos	Z Position of light source; equals a layer Z position of + / - 50.000	0-65535	32768

▼ **Texture Projection**



This is the same effect as ["Texture Projection Add"](#)<sup>493</sup> but without the parameters XY Offset.

Parameter	Description	Value Range	Default
Mix	Level of effect itself	0-255	0
Media	Media file as source for overlay or mask	-	-
Light Source X Pos	Light Source X Pos	-999.999-999.999	0
Light Source Y Pos	Light Source Y Pos	-999.999-999.999	10
Light Source Z Pos	Light Source Z Pos	-999.999-999.999	-25
Light Target X Pos	Light Target X Pos	-999.999-999.999	0
Light Target Y Pos	Light Target Y Pos	-999.999-999.999	0
Light Target Z Pos	Light Target Z Pos	-999.999-999.999	0
Light Angle	Light Angle	0-180	20
Light Aspect	Light Aspect	0-20	1
Light Z Roll	Light Z Roll	-9999.99-9999.99	0
X Offset	X Offset	-999.999-999.999	0
Y Offset	Y Offset	-999.999-999.999	0

### 5.4.2.11.30 LIGHTING - TEXTURE PROJECTION

#### ▼ Texture Projection Add

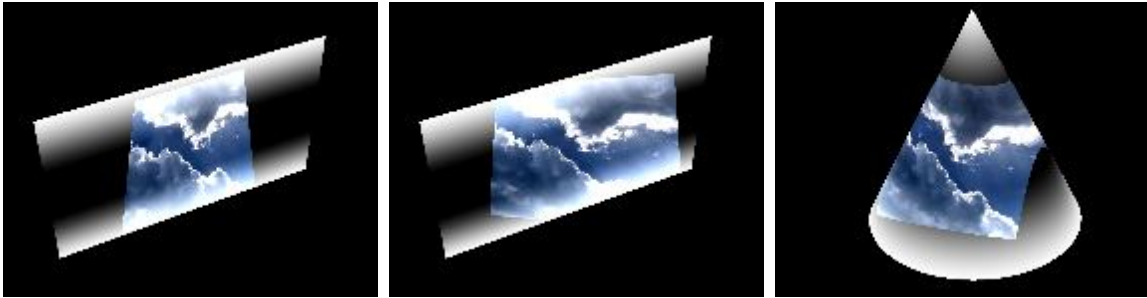

This allows to simulate a projected image on a layer. There are similarities to the effect "[Light Texture Projection](#)"<sup>491</sup>, but as it combines the Light Layer parameters into the effect itself, no additional [Light Layer](#)<sup>582</sup> is needed.

The left image depicts the scene. The Layer texture itself is a white-black-white gradient, the projected texture (FX media) is a cloud image. For the second image, the position for the effect's light source has changed, resulting in a different angle for the projection. In the right image, a 3D cone was used as a Layer object.

Note that (in difference to "[Texture Projection Mix](#)"<sup>498</sup>) the RGB values from the FX texture are added to the RGB values from the layer texture. This explains why the top left and bottom right corner of the cloud image cannot be seen on top the gradient texture as these areas are already full white.

Parameter	Description	Value Range	Default
Mix	Level of effect itself	0-255	0
Media	Media file as source for overlay or mask	-	-
Light Source X Pos	Light Source X Pos	-999.999-999.999	0
Light Source Y Pos	Light Source Y Pos	-999.999-999.999	10
Light Source Z Pos	Light Source Z Pos	-999.999-999.999	-25
Light Target X Pos	Light Target X Pos	-999.999-999.999	0
Light Target Y Pos	Light Target Y Pos	-999.999-999.999	0
Light Target Z Pos	Light Target Z Pos	-999.999-999.999	0
Light Angle	Light Angle	0-180	20
Light Aspect	Light Aspect	0-20	1
Light Z Roll	Light Z Roll	-9999.99-9999.99	0
X Offset	X Offset	-999.999-999.999	0
Y Offset	Y Offset	-999.999-999.999	0

▼ Texture Projection Alpha Mix AB



This allows to simulate a projected image on a layer, and mixes it with the transparency from the FX media. The FX can blend between two textures. There are similarities to the effect "[Light Texture Projection](#)"<sup>491</sup>, but as it combines the Light Layer parameters into the effect itself, no additional [Light Layer](#)<sup>582</sup> is needed.

The left image depicts the scene. In front of a background cloud image, you can see the layer texture, a white-black-white gradient. The projected texture (FX media) is transparent with colorful circles. The transparency channel is projected onto the gradient layer and creates transparent areas there. The Mix parameter is at 100.

For the second image, the Mix parameter was risen to 255.

In the right image, the second FX media (stars on a transparent background) is taking place as the "Mix AB" parameter is toggled.

Note that (in difference to "[Texture Projection Mix](#)"<sup>498</sup> and [...Add](#)<sup>493</sup>) the RGB values from the FX textures are discarded. It is only the alpha information that overlays the RGB values from the layer texture.

Parameter	Description	Value Range	Default
Mix	Level of effect itself	0-255	0
Media1	Media1	-	-
Mix AB	Mix AB	0-255	0
Media2	Media2	-	-
Light Source X Pos	Light Source X Pos	-999.999-999.999	0
Light Source Y Pos	Light Source Y Pos	-999.999-999.999	10
Light Source Z Pos	Light Source Z Pos	-999.999-999.999	-25
Light Target X Pos	Light Target X Pos	-999.999-999.999	0
Light Target Y Pos	Light Target Y Pos	-999.999-999.999	0
Light Target Z Pos	Light Target Z Pos	-999.999-999.999	0
Light Angle	Light Angle	0-180	20
Light Aspect	Light Aspect	0-20	1
Light Z Roll	Light Z Roll	-9999.99-9999.99	0
X Offset	X Offset	-999.999-999.999	0
Y Offset	Y Offset	-999.999-999.999	0

▼ Texture Projection Alpha Mix

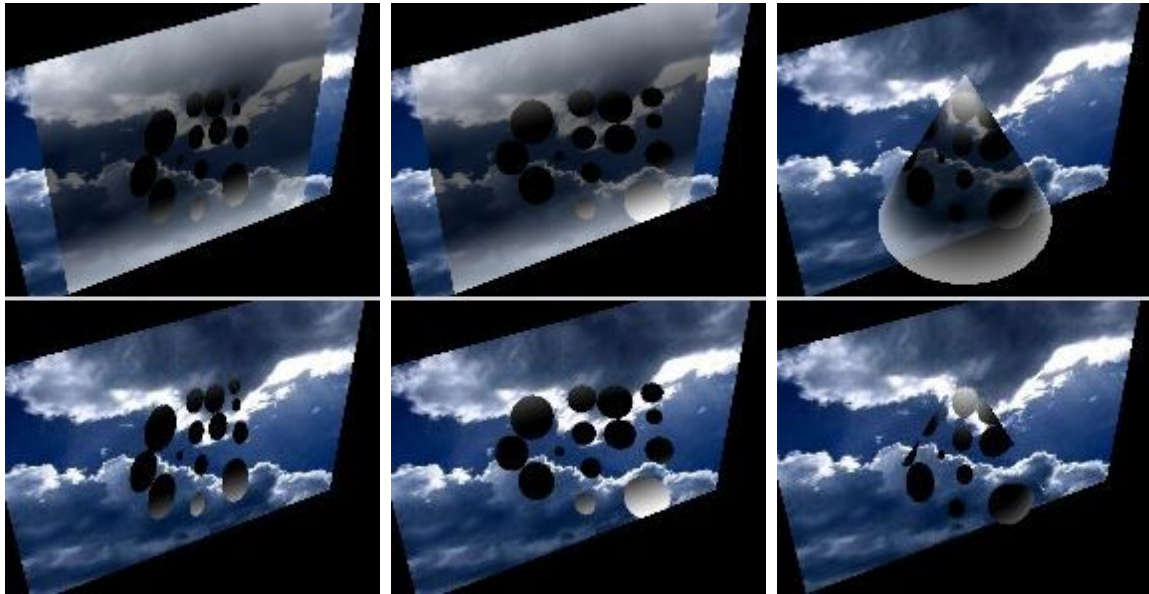

This allows to simulate a projected image on a layer, and mixes it with the transparency from the FX media. There are similarities to the effect "[Light Texture Projection](#)"<sup>491</sup>, but as it combines the Light Layer parameters into the effect itself, no additional [Light Layer](#)<sup>582</sup> is needed.

The left image depicts the scene. In front of a background cloud image, you can see the layer texture, a white-black-white gradient. The projected texture (FX media) is transparent with colorful circles. The transparency channel is projected onto the gradient layer and creates transparent areas there. For the second image, the position for the effect's light source has changed, resulting in a different angle for the projection. In the right image, a 3D cone was used as a Layer object.

Note that (in difference to "[Texture Projection Mix](#)"<sup>498</sup> and [...Add](#)<sup>493</sup>) the RGB values from the FX texture are discarded. It is only the alpha information that overlays the RGB values from the layer texture.

Parameter	Description	Value Range	Default
Mix	Level of effect itself	0-255	0
Media	Media file as source for overlay or mask	-	-
Light Source X Pos	Light Source X Pos	-999.999-999.999	0
Light Source Y Pos	Light Source Y Pos	-999.999-999.999	10
Light Source Z Pos	Light Source Z Pos	-999.999-999.999	-25
Light Target X Pos	Light Target X Pos	-999.999-999.999	0
Light Target Y Pos	Light Target Y Pos	-999.999-999.999	0
Light Target Z Pos	Light Target Z Pos	-999.999-999.999	0
Light Angle	Light Angle	0-180	20
Light Aspect	Light Aspect	0-20	1
Light Z Roll	Light Z Roll	-9999.99-9999.99	0

X Offset	X Offset	-999.999-999.999	0
Y Offset	Y Offset	-999.999-999.999	0

▼ **Texture Projection Blend AB**



This allows to simulate a projected image on a layer. Two FX textures can be used and blended. There are similarities to the effect "[Light Texture Projection](#)"<sup>491</sup>, but as it combines the Light Layer parameters into the effect itself, no additional [Light Layer](#)<sup>582</sup> is needed.

The left image depicts the scene. The Layer texture itself is a white-black-white gradient, the projected texture (FX media) is a cloud image. The Mix parameter is at 100. For the second image, the Mix parameter was risen to 255. In the right image, the second FX media (grass image) is taking place as the "Mix AB" parameter is toggled.

Note that (in difference to "[Texture Projection Add](#)"<sup>493</sup>) the RGB values from the FX texture overlay the RGB values from the layer texture, but not if there is no projection.

Parameter	Description	Value Range	Default
Mix	Level of effect itself	0-255	0
Media1	Media1	-	-
Mix AB	Mix AB	0-255	0
Media2	Media2	-	-
Light Source X	Light Source X Pos	-999.999-999.999	0
Light Source Y	Light Source Y Pos	-999.999-999.999	10
Light Source Z	Light Source Z Pos	-999.999-999.999	-25
Light Target X	Light Target X Pos	-999.999-999.999	0
Light Target Y	Light Target Y Pos	-999.999-999.999	0
Light Target Z	Light Target Z Pos	-999.999-999.999	0
Light Angle	Light Angle	0-180	20
Light Aspect	Light Aspect	0-20	1
Light Z Roll	Light Z Roll	-9999.99-9999.99	0
X Offset	X Offset	-999.999-999.999	0
Y Offset	Y Offset	-999.999-999.999	0



▼ Texture Projection Mix AB



This allows to simulate a projected image on a layer. Two FX textures can be used and blended. There are similarities to the effect "[Light Texture Projection](#)"<sup>491</sup>, but as it combines the Light Layer parameters into the effect itself, no additional [Light Layer](#)<sup>582</sup> is needed.

The left image depicts the scene. The Layer texture itself is a white-black-white gradient, the projected texture (FX media) is a cloud image. The Mix parameter is at 100.

For the second image, the Mix parameter was risen to 255.

In the right image, the second FX media (grass image) is taking place as the "Mix AB" parameter is toggled.

Note that (in difference to "[Texture Projection Add](#)"<sup>493</sup>) the RGB values from the FX texture overlay the RGB values from the layer texture. This explains why the layer texture disappears when the Mix parameter equals 255.

Parameter	Description	Value Range	Default
Mix	Level of effect itself	0-255	0
Media1	Media1	-	-
Mix AB	Mix AB	0-255	0
Media2	Media2	-	-
Light Source X Pos	Light Source X Pos	-999.999-999.999	0
Light Source Y Pos	Light Source Y Pos	-999.999-999.999	10
Light Source Z Pos	Light Source Z Pos	-999.999-999.999	-25
Light Target X Pos	Light Target X Pos	-999.999-999.999	0
Light Target Y Pos	Light Target Y Pos	-999.999-999.999	0
Light Target Z Pos	Light Target Z Pos	-999.999-999.999	0
Light Angle	Light Angle	0-180	20
Light Aspect	Light Aspect	0-20	1
Light Z Roll	Light Z Roll	-9999.99-9999.99	0
X Offset	X Offset	-999.999-999.999	0
Y Offset	Y Offset	-999.999-999.999	0

▼ Texture Projection Mix

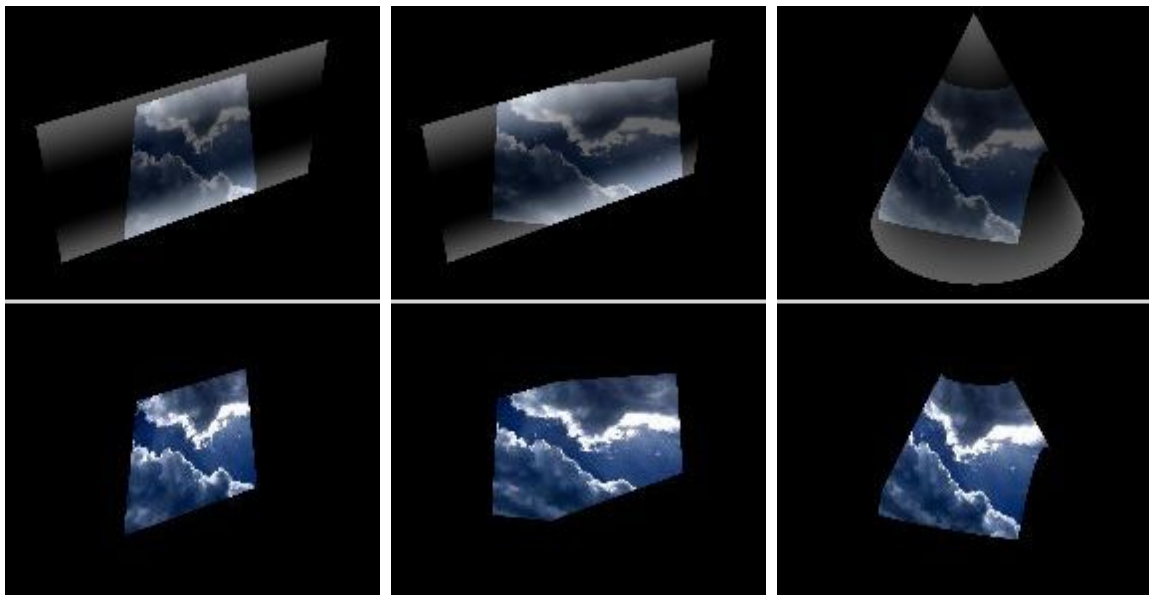

This allows to simulate a projected image on a layer. There are similarities to the effect "[Light Texture Projection](#)"<sup>491</sup>, but as it combines the Light Layer parameters into the effect itself, no additional [Light Layer](#)<sup>582</sup> is needed.

The left image depicts the scene. The Layer texture itself is a white-black-white gradient, the projected texture (FX media) is a cloud image. In the upper image, the Mix parameter is at 100; in the bottom one at 255. For the second image, the position for the effect's light source has changed, resulting in a different angle for the projection. In the right image, a 3D cone was used as a Layer object.

Note that (in difference to "[Texture Projection Add](#)"<sup>493</sup>) the RGB values from the FX texture overlay the RGB values from the layer texture. This explains why the layer texture disappears when the Mix parameter equals 255.

Parameter	Description	Value Range	Default
Mix	Level of effect itself	0-255	0
Media	Media file as source for overlay or mask	-	-
Light Source X Pos	Light Source X Pos	-999.999-999.999	0
Light Source Y Pos	Light Source Y Pos	-999.999-999.999	10
Light Source Z Pos	Light Source Z Pos	-999.999-999.999	-25
Light Target X Pos	Light Target X Pos	-999.999-999.999	0
Light Target Y Pos	Light Target Y Pos	-999.999-999.999	0
Light Target Z Pos	Light Target Z Pos	-999.999-999.999	0
Light Angle	Light Angle	0-180	20
Light Aspect	Light Aspect	0-20	1
Light Z Roll	Light Z Roll	-9999.99-9999.99	0

X Offset	X Offset	-999.999-999.999	0
Y Offset	Y Offset	-999.999-999.999	0

▼ **Texture Projection**

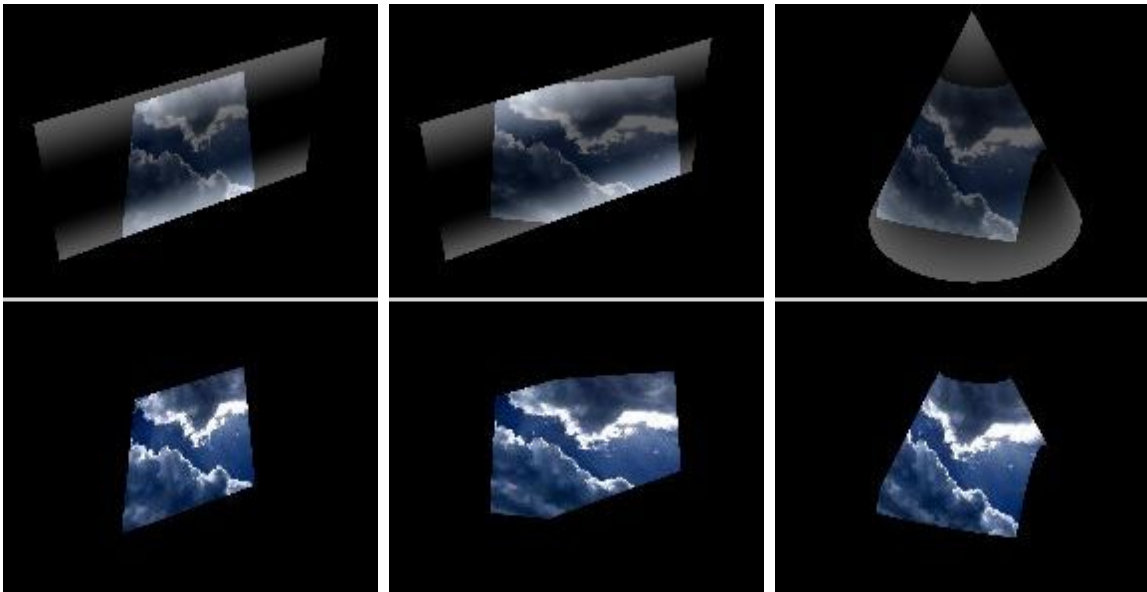

This is the same effect as ["Texture Projection Mix"](#)<sup>498</sup> but without the parameters XY Offset.

Parameter	Description	Value Range	Default
Mix	Level of effect itself	0-255	0
Media	Media file as source for overlay or mask	-	-
Light Source X Pos	Light Source X Pos	-999.999-999.999	0
Light Source Y Pos	Light Source Y Pos	-999.999-999.999	10
Light Source Z Pos	Light Source Z Pos	-999.999-999.999	-25
Light Target X Pos	Light Target X Pos	-999.999-999.999	0
Light Target Y Pos	Light Target Y Pos	-999.999-999.999	0
Light Target Z Pos	Light Target Z Pos	-999.999-999.999	0
Light Angle	Light Angle	0-180	20
Light Aspect	Light Aspect	0-20	1
Light Z Roll	Light Z Roll	-9999.99-9999.99	0

### 5.4.2.11.31 MASKING

#### ▼ Alpha Black Fill RGB

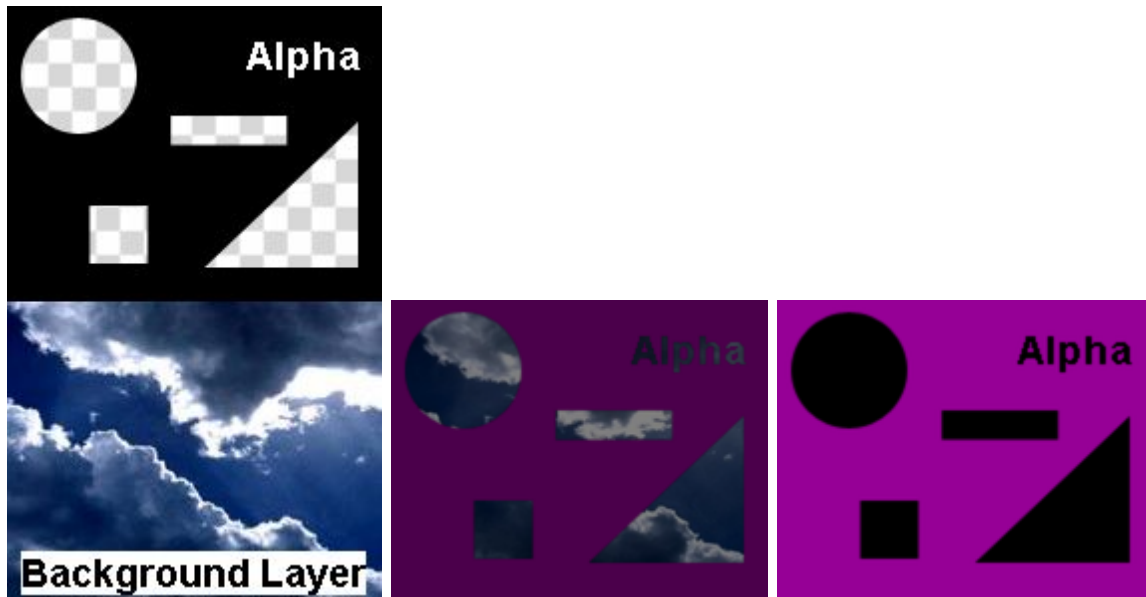

Turns all parts containing alpha into black and allows choosing any RGB color for the non-transparent parts of the image.

Parameter	Description	Value Range	Default
Mix	Level of Effect	0-255	0
Red	Red level, Color Picker	0-255	0
Green	Green level, Color Picker	0-255	0
Blue	Blue level, Color Picker	0-255	0

#### ▼ Alpha Fill RGB

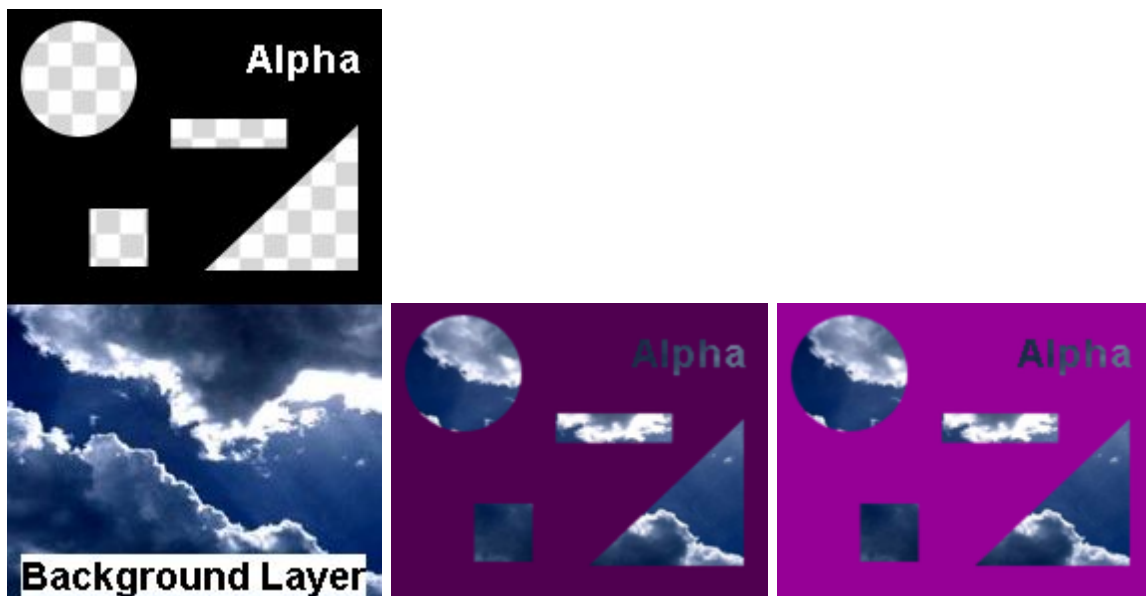

All parts of the image containing alpha stay transparent, allows choosing any RGB color for the non-transparent parts of the image.

Parameter	Description	Value Range	Default
Mix	Level of Effect	0-255	0
Red	Red level, Color Picker	0-255	0
Green	Green level, Color Picker	0-255	0
Blue	Blue level, Color Picker	0-255	0

▼ Alpha Left Right

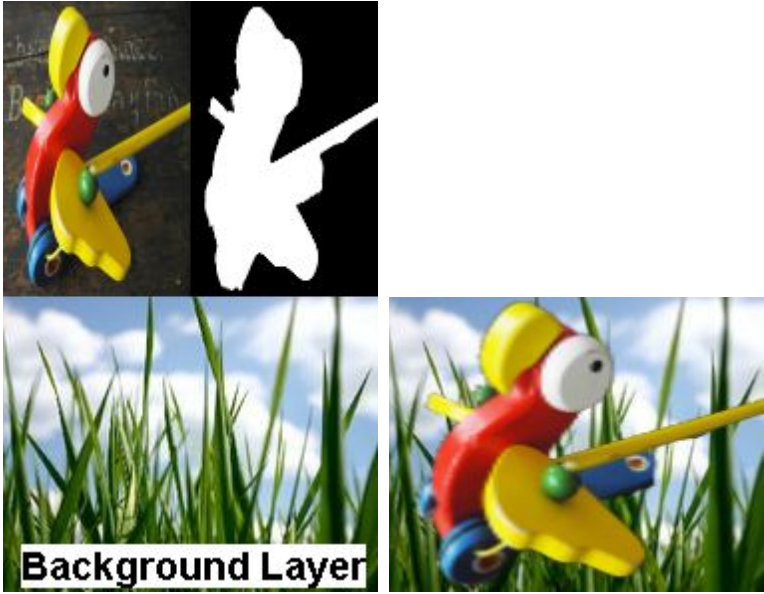

The effect expects one media file on the layer that contains two information side-by-side. The left half represents the video itself whilst the masking information is in the right half. You may prepare such content using the [Image Converter](#)<sup>840</sup>.

Parameter	Description	Value Range	Default
Mix	Level of effect itself	0-255	0

▼ Alpha Media As Mask Invert



All parts of the layer texture containing alpha will stay transparent, all non-transparent parts of an additional media file will turn the corresponding parts of the layer texture transparent as well.

Parameter	Description	Value Range	Default
Mix	Level of Effect	0-255	0
Media	Alpha Media as Mask Invert		

▼ Alpha Media As Mask

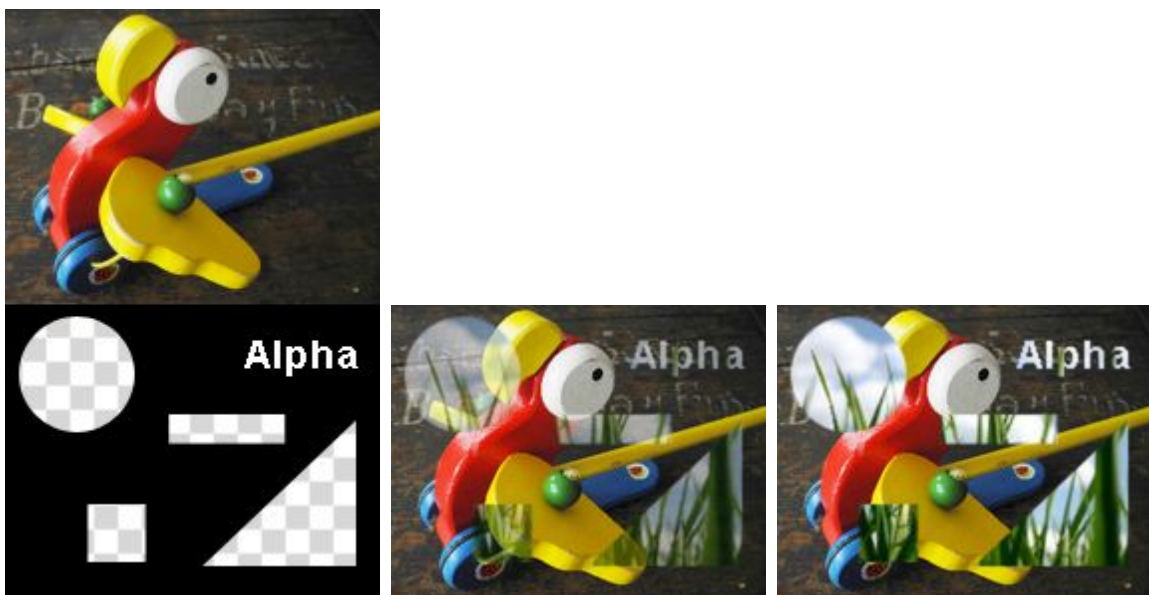

All parts of the layer texture containing alpha will stay transparent, all transparent parts of an additional media file will turn the corresponding parts of the layer texture transparent as well.

Parameter	Description	Value Range	Default
Mix	Level of Effect	0-255	0

▼ Alpha Replace

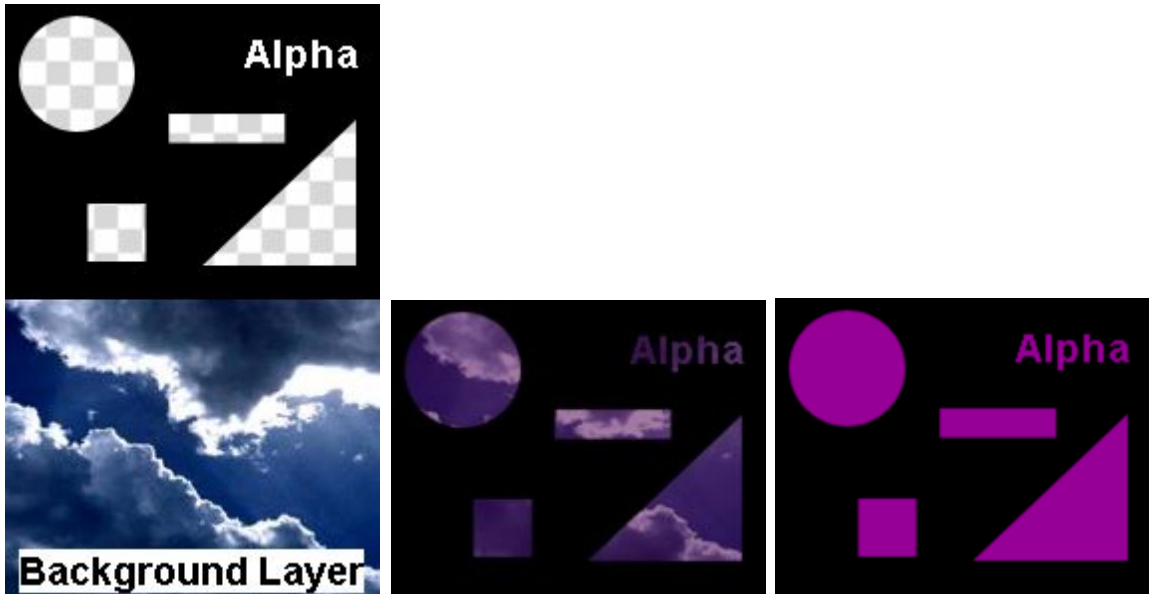

All parts of the layer texture containing alpha will be replaced by any RGB color.

Parameter	Description	Value Range	Default
Mix	Level of Effect	0-255	0
Red	Red level, Color Picker	0-255	0
Green	Green level, Color Picker	0-255	0
Blue	Blue level, Color Picker	0-255	0

▼ Alpha Top Bottom

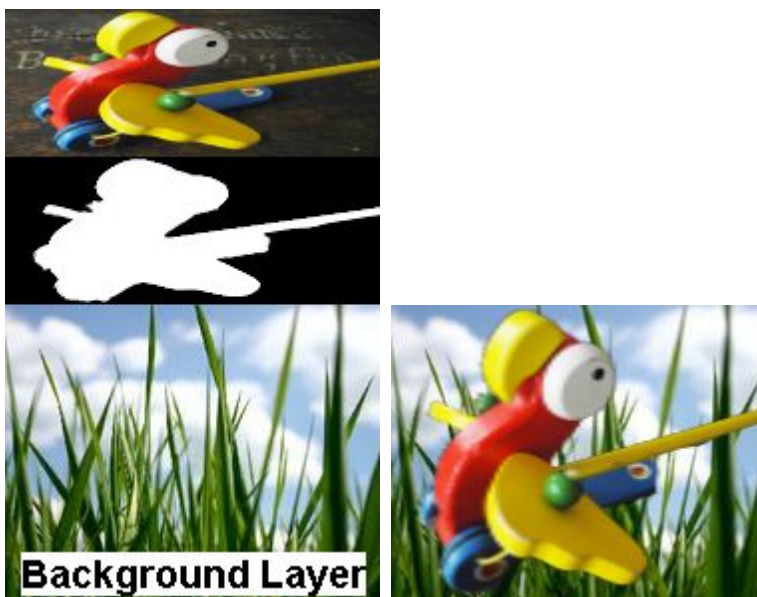

The effect expects one media file on the layer that contains two information on top of each other. The upper half represents the video itself whilst the masking information is in the lower half. You may prepare such content using the [Image Converter](#)<sup>840</sup>.

Parameter	Description	Value Range	Default
Mix	Level of effect itself	0-255	0

▼ **BW Mask**

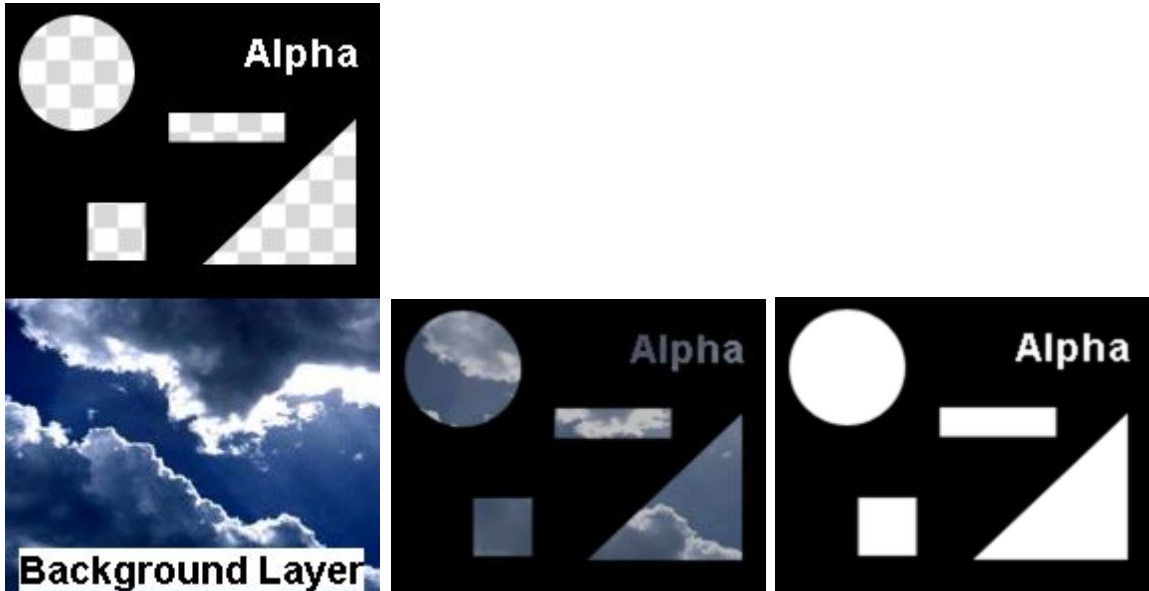

All parts of the layer texture containing alpha will be turned into white, all non-transparent parts will be turned into black.

Parameter	Description	Value Range	Default
Mix	Level of Effect	0-255	0

▼ **BW Media As Mask Invert**

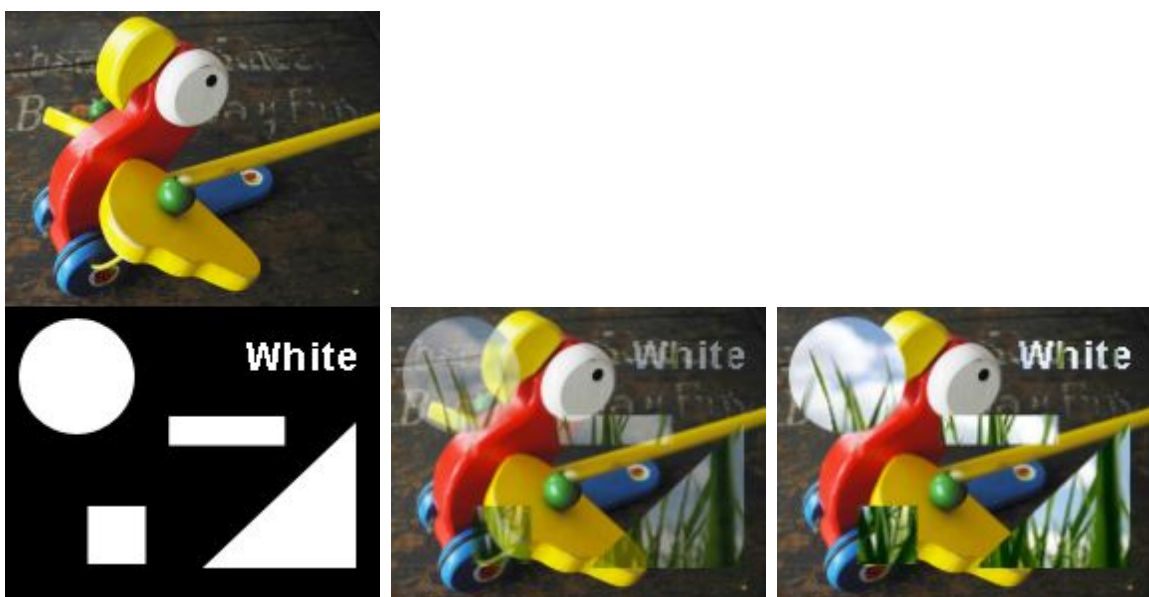



All white parts of an additional media file will turn the corresponding parts of the layer texture transparent, black parts do not influence the layer texture.

Parameter	Description	Value Range	Default
Mix	Level of Effect	0-255	0
Media	BW Media as Mask Invert		

▼ **BW Media as Mask PreMul**

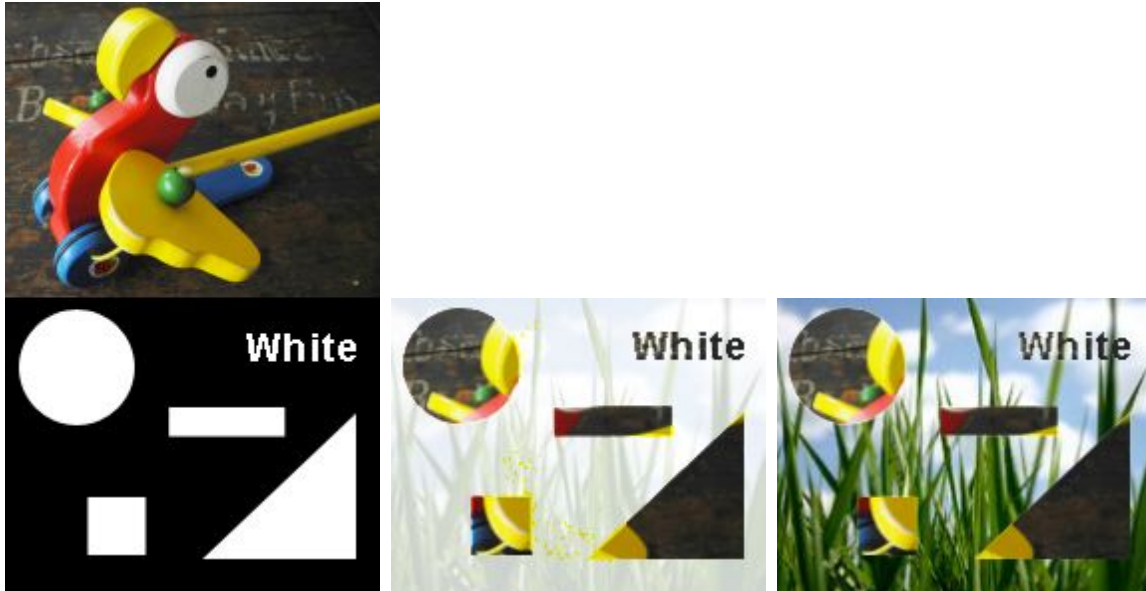

All black parts of an additional media file will turn the corresponding parts of the layer texture transparent, white parts do not influence the layer texture. In addition to the "[BW Media As Mask](#)<sup>506</sup>" effect the RGB values of the keyed out area are pre-multiplied before being turned transparent. This means that all RGB values between 1-255 are set to 255 turning most pixels into white ones. Only RGB values of 0 stay unchanged. In the second image you can see that some pixels from the wing are rendered in yellow because originally their blue value was 0.

Parameter	Description	Value Range	Default
Mix	Level of effect itself	0-255	0
Media	Media file as source for overlay or mask	-	-

▼ **BW Media As Mask**



All black parts of an additional media file will turn the corresponding parts of the layer texture transparent, white parts do not influence the layer texture.

Parameter	Description	Value Range	Default
Mix	Level of Effect	0-255	0
Media	BW Media as Mask		

▼ **WB Mask**



All parts of the layer texture containing alpha will be turned into black, all non-transparent parts will be turned into white.

Parameter	Description	Value Range	Default
Mix	Level of Effect	0-255	0

### 5.4.2.11.32 MIRROR

#### ▼ Horizontal Flip



Mirrors the texture layer horizontally, what was on the left side will be on the right.

Parameter	Description	Value Range	Default
Mix	Level of effect itself	0-255	0

#### ▼ HV Flip



Mirrors the texture layer vertically and horizontally; in other words, it rotates the layer by 180°.

Parameter	Description	Value Range	Default
Mix	Level of effect itself	0-255	0

#### ▼ Mirror 2D



Mirrors the layer texture vertically with a slight transparent fade-out. The vertical position can be adjusted, the mirrored part may be colored by any RGB color as well.

Parameter	Description	Value Range	Default
Mix	Level of Effect	0-255	0
Pos V	Vertical Position of the Mirroring	0-65535	32768
Alpha	Alpha level of the mirrored image	0-255	128

Red	Red level, Color Picker	0-255	128
Green	Green level, Color Picker	0-255	128
Blue	Blue level, Color Picker	0-255	128

▼ **Vertical Flip**



Mirrors the texture layer vertically, what was on the top side, will be on the bottom.

Parameter	Description	Value Range	Default
Mix	Level of effect itself	0-255	0

**5.4.2.11.33 OVERLAY**

▼ **Horizontal Dual Media Overlay**

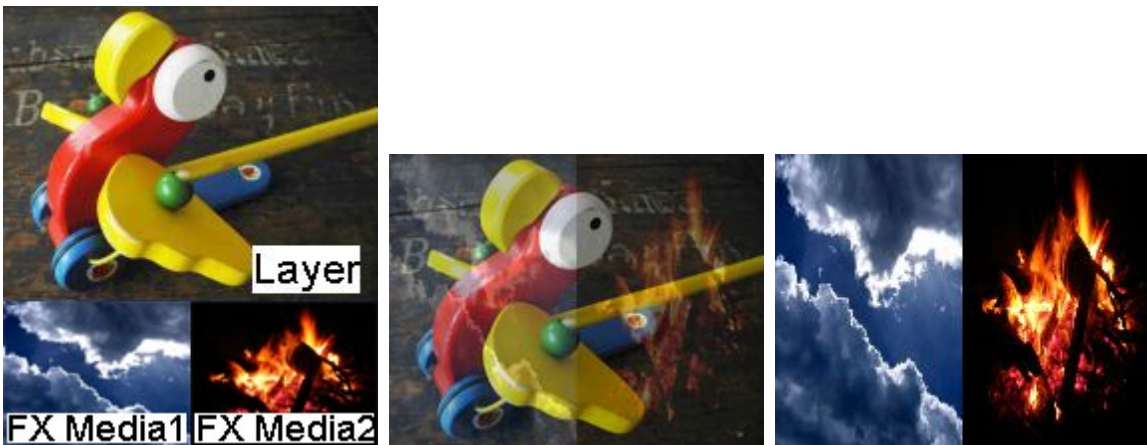

Mixes the current texture (media file) from the layer with the FX textures. Both FX textures are displayed next to each other, taking up the full height but only 1/2 width of the layer texture. The layer texture holds the resolution information. In the Stock Assets content you may find transparent images with different resolutions (C:\coolux\content\Stock Assets\Textures\Alpha Dummy).

Parameter	Description	Value Range	Default
Mix	Level of effect itself	0-255	0
Media1	Media1	-	-
Media2	Media2	-	-

▼ Horizontal Quad Media Overlay



Mixes the current texture (media file) from the layer with the FX textures. All four FX textures are displayed next to each other, taking up the full height but only 1/4 width of the layer texture. The layer texture holds the resolution information. In the Stock Assets content you may find transparent images with different resolutions (C:\coolux\content\Stock Assets\Textures\Alpha Dummy).

Parameter	Description	Value Range	Default
Mix	Level of effect itself	0-255	0
Media1	Media1	-	-
Media2	Media2	-	-
Media3	Media3	-	-
Media4	Media4	-	-

▼ Horizontal Triple Media Overlay



Mixes the current texture (media file) from the layer with the FX textures. All three FX textures are displayed next to each other, taking up the full height but only 1/3 of the width of the layer texture. The layer texture holds the resolution information. In the Stock Assets content you may find transparent images with different resolutions (C:\coolux\content\Stock Assets\Textures\Alpha Dummy).

Parameter	Description	Value Range	Default
Mix	Level of effect itself	0-255	0
Media1	Media1	-	-
Media2	Media2	-	-
Media3	Media3	-	-

▼ Media Overlay Add



Allows overlaying the layer texture with a media file by adding the pixel RGB values of the media file with the layer texture. Position and scaling of the overlaying media file can be adjusted.

Parameter	Description	Value Range	Default
Mix	Level of Effect	0-255	0
X	X Position of the overlaying media file	0-65535	32768
Y	Y Position of the overlaying media file	0-65535	32768
Width	Red level, Color Picker	0-65535	65535
Height	Green level, Color Picker	0-65535	65535
Media	Overlaying Media File		

▼ **Media Overlay Darken**

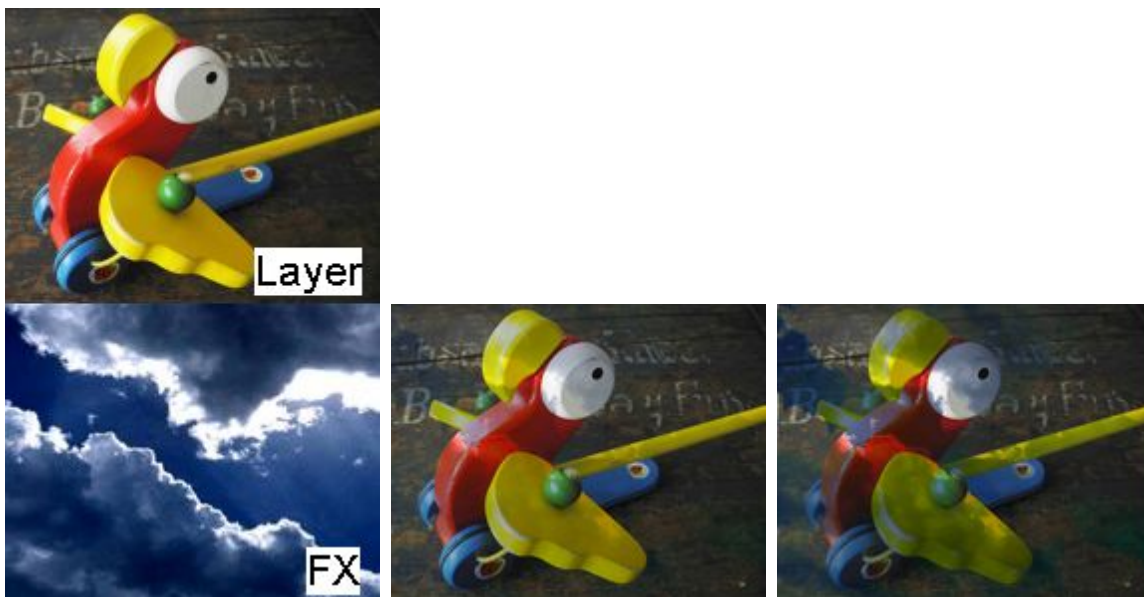

Allows overlaying the layer texture with a media file by darkening the layer texture with the RGB values of the media file. Position and scaling of the overlaying media can be adjusted.

Parameter	Description	Value Range	Default
Mix	Level of effect itself	0-255	0
X	X	0-65535	32768
Y	Y	0-65535	32768
Width	Width	0-65535	65535
Height	Height	0-65535	65535
Media	Media file as source for overlay or mask	-	-

▼ Media Overlay Divide Inv



Allows overlaying the layer texture with a media file by inverting the division of layer texture and RGB values of the media file. Position and scaling of the overlaying media can be adjusted.

Parameter	Description	Value Range	Default
Mix	Level of effect itself	0-255	0
X	X	0-65535	32768
Y	Y	0-65535	32768
Width	Width	0-65535	65535
Height	Height	0-65535	65535
Media	Media file as source for overlay or mask	-	-

▼ Media Overlay Divide





Allows overlaying the layer texture with a media file by dividing the layer texture and the RGB values of the media file. Position and scaling of the overlaying media can be adjusted.

Parameter	Description	Value Range	Default
Mix	Level of effect itself	0-255	0
X	X	0-65535	32768
Y	Y	0-65535	32768
Width	Width	0-65535	65535
Height	Height	0-65535	65535
Media	Media file as source for overlay or mask	-	-

▼ Media Overlay Hue

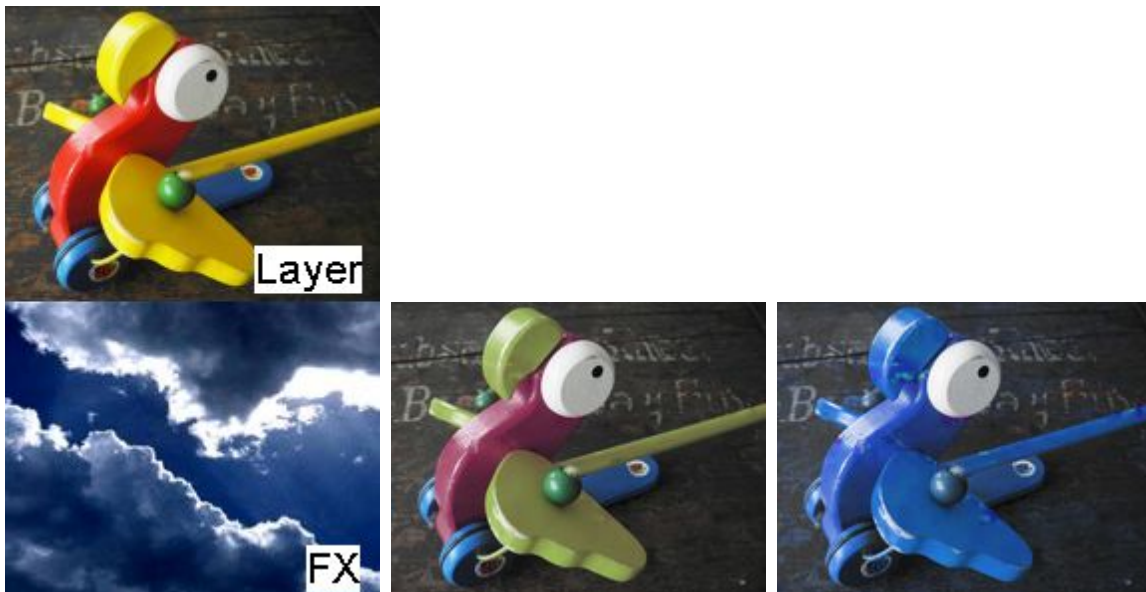

Allows overlaying the layer texture with a media file by mixing the layer texture with the RGB hue values of the media file. Position and scaling of the overlaying media can be adjusted.

Parameter	Description	Value Range	Default
Mix	Level of effect itself	0-255	0
X	X	0-65535	32768
Y	Y	0-65535	32768
Width	Width	0-65535	65535
Height	Height	0-65535	65535
Media	Media file as source for overlay or mask	-	-

▼ Media Overlay Lighten

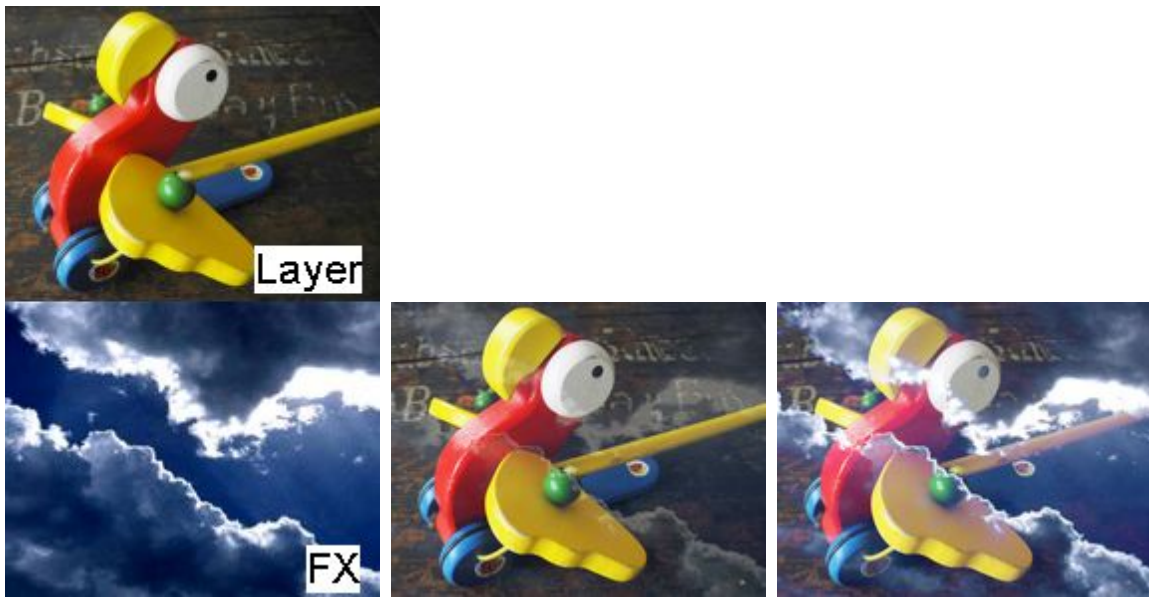

Allows overlaying the layer texture with a media file by lightening up the layer texture with the RGB values of the media file. Position and scaling of the overlaying media can be adjusted.

Parameter	Description	Value Range	Default
Mix	Level of effect itself	0-255	0
X	X	0-65535	32768
Y	Y	0-65535	32768
Width	Width	0-65535	65535
Height	Height	0-65535	65535
Media	Media file as source for overlay or mask	-	-

▼ Media Overlay Mix

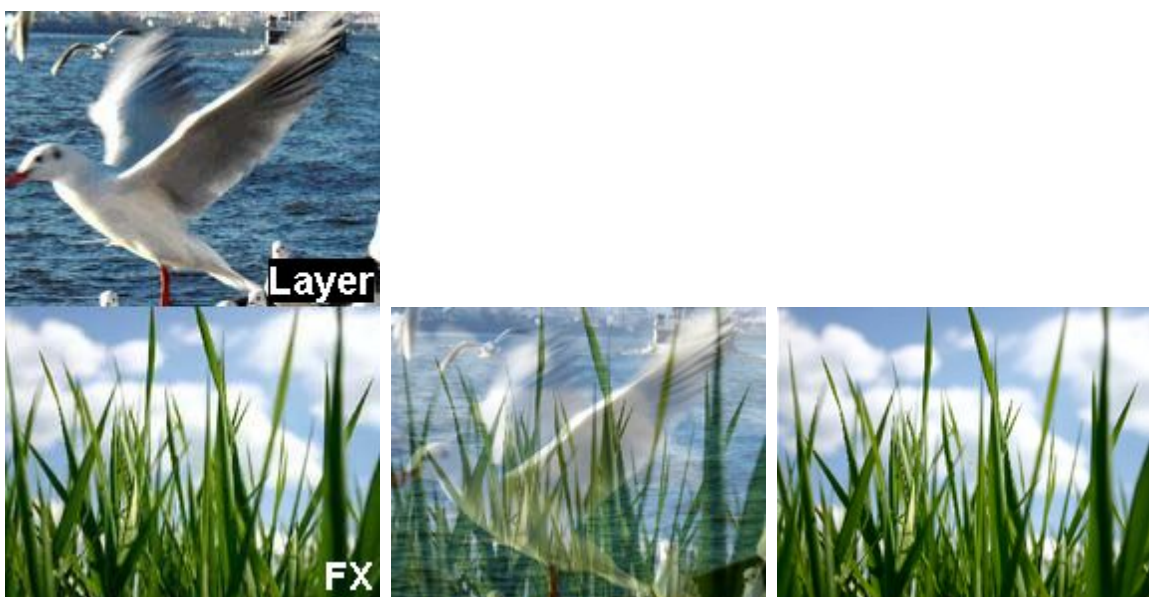

Allows overlaying the layer texture with a media file by mixing the pixel RGB values of the layer texture with the media file. Position and scaling of the overlaying media file can be adjusted.

Parameter	Description	Value Range	Default
Mix	Level of Effect	0-255	0
X	X Position of the overlaying media file	0-65535	32768
Y	Y Position of the overlaying media file	0-65535	32768
Width	Red level, Color Picker	0-65535	65535
Height	Green level, Color Picker	0-65535	65535
Media	Overlaying Media File		

▼ **Media Overlay Multiply**

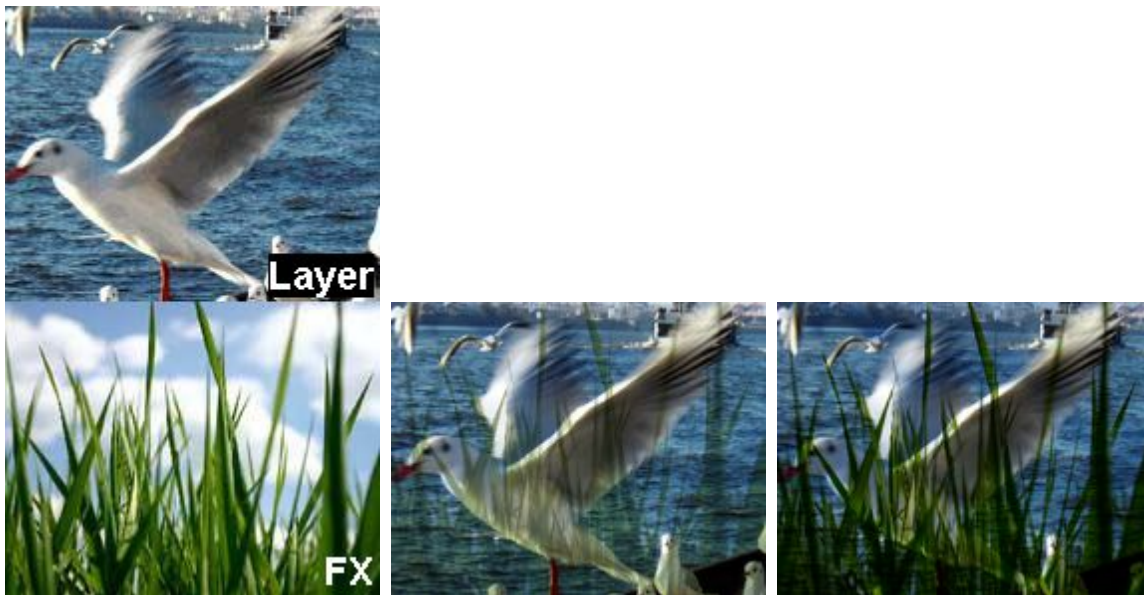

Allows overlaying the layer texture with a media file by multiplying the pixel RGB values of the layer texture with the media file. Position and scaling of the overlaying media file can be adjusted.

Parameter	Description	Value Range	Default
Mix	Level of Effect	0-255	0
X	X Position of the overlaying media file	0-65535	32768
Y	Y Position of the overlaying media file	0-65535	32768
Width	Red level, Color Picker	0-65535	65535
Height	Green level, Color Picker	0-65535	65535
Media	Overlaying Media File		

▼ Media Overlay Screen

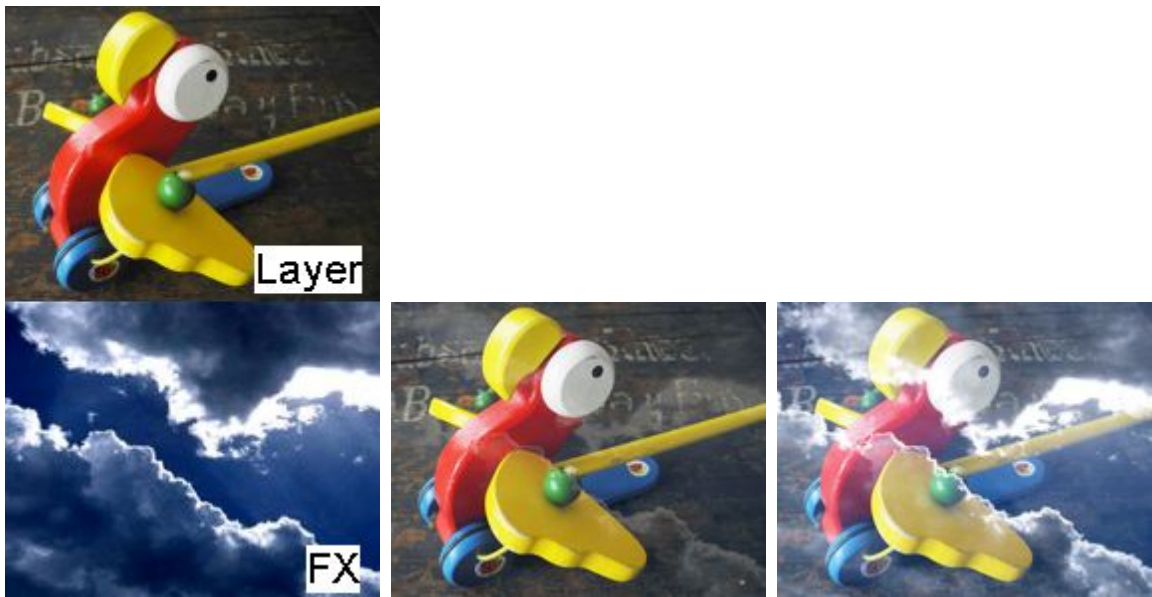

Allows overlaying the layer texture with a media file by using the screen blend mode, i.e. negating the RGB values of both textures, then multiplying them and negating them again. The result is a brighter image. Position and scaling of the overlaying media can be adjusted.

Parameter	Description	Value Range	Default
Mix	Level of effect itself	0-255	0
X	X	0-65535	32768
Y	Y	0-65535	32768
Width	Width	0-65535	65535
Height	Height	0-65535	65535
Media	Media file as source for overlay or mask	-	-

▼ Media Overlay Subtract

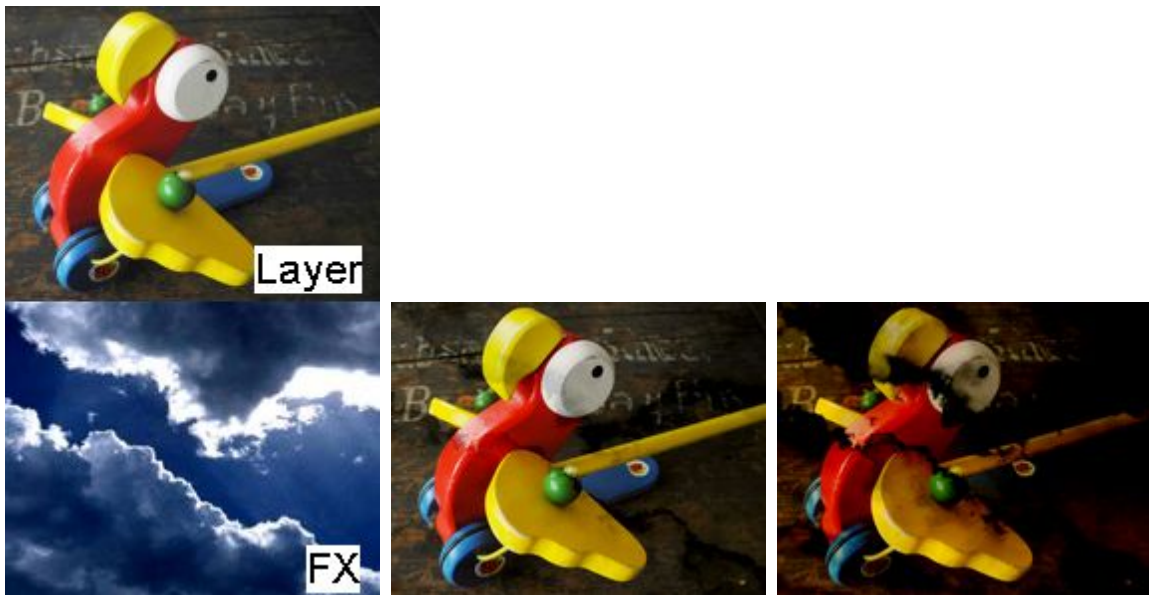

Allows overlaying the layer texture with a media file by subtracting the RGB values of the media file from the layer texture. Position and scaling of the overlaying media can be adjusted.

Parameter	Description	Value Range	Default
Mix	Level of effect itself	0-255	0
X	X	0-65535	32768
Y	Y	0-65535	32768
Width	Width	0-65535	65535
Height	Height	0-65535	65535
Media	Media file as source for overlay or mask	-	-

▼ Quad Media Overlay



Mixes the current texture (media file) from the layer with the FX textures. All four FX textures are displayed in a 2x2 grid, each taking up 1/2 height and 1/2 width of the layer texture. The layer texture holds the resolution information. In the Stock Assets content you may find transparent images with different resolutions (C:\coolux\content\Stock Assets\Textures\Alpha Dummy).

Parameter	Description	Value Range	Default
Mix	Level of effect itself	0-255	0
Media1	Media1	-	-
Media2	Media2	-	-
Media3	Media3	-	-
Media4	Media4	-	-

▼ Vertical Dual Media Overlay

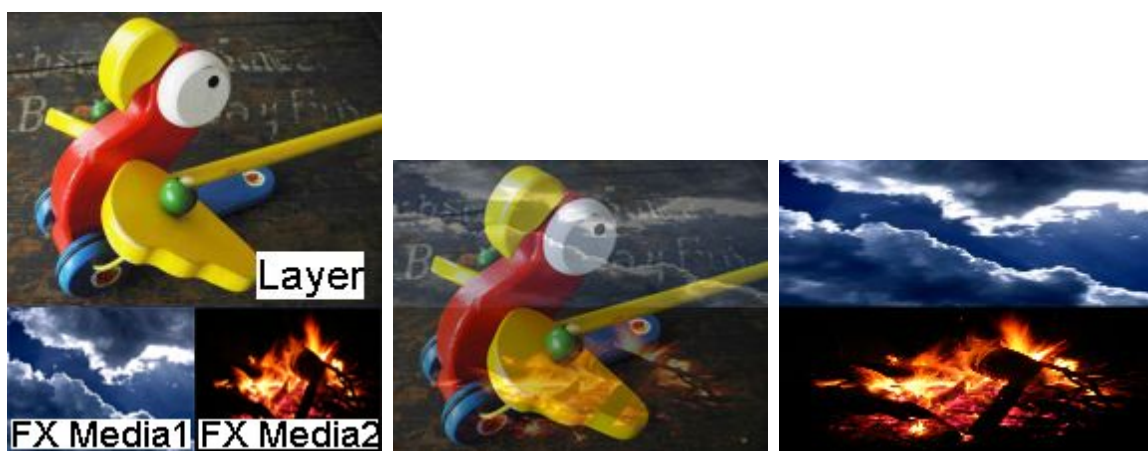

Mixes the current texture (media file) from the layer with the FX textures. Both FX textures are displayed one upon the other, taking up the full width but only 1/2 height of the layer texture. The layer texture holds the resolution information. In the Stock Assets content you may find transparent images with different resolutions (C:\coolux\content\Stock Assets\Textures\Alpha Dummy).

Parameter	Description	Value Range	Default
Mix	Level of effect itself	0-255	0
Media1	Media1	-	-
Media2	Media2	-	-

▼ Vertical Quad Media Overlay



Mixes the current texture (media file) from the layer with the FX textures. All four FX textures are displayed one upon the other, taking up the full width but only 1/4 height of the layer texture. The layer texture holds the resolution information. In the Stock Assets content you may find transparent images with different resolutions (C:\coolux\content\Stock Assets\Textures\Alpha Dummy).

Parameter	Description	Value Range	Default
Mix	Level of effect itself	0-255	0
Media1	Media1	-	-
Media2	Media2	-	-
Media3	Media3	-	-
Media4	Media4	-	-

▼ Vertical Triple Media Overlay



Mixes the current texture (media file) from the layer with the FX textures. All three FX textures are displayed one upon the other, taking up the full width but only 1/3 height of the layer texture. The layer texture holds the resolution information. In the Stock Assets content you may find transparent images with different resolutions (C:\coolux\content\Stock Assets\Textures\Alpha Dummy).

Parameter	Description	Value Range	Default
Mix	Level of effect itself	0-255	0
Media1	Media1	-	-
Media2	Media2	-	-
Media3	Media3	-	-

5.4.2.11.34 PATTERN

▼ BinaryPattern



Turns the layer texture into a binary pattern, the number of horizontal and vertical lines is adjustable.

Parameter	Description	Value Range	Default
Mix	Level of effect itself	0-255	0
Horizontal	Horizontal	0-16	0
Vertical	Vertical	0-16	0



Invert      Inverts the RGB levels or the effect    0-1      0

▼ **Checkerboard**



Adds a checkerboard of any RGB color and alpha level to the layer texture. The following parameters can be adjusted as well: Amount, Softness, Size, Offset X&Y.

Parameter	Description	Value Range	Default
Mix	Level of Effect	0-255	0
Amount	Amount of checkers	0-65535	1024
Softness	Softness of checker edges	0-65535	32
Size	Size of checkers	0-65535	32768
Offset X	Horizontal Offset	0-65535	32768
Offset Y	Vertical Offset	0-65535	32768
Red	Red level, Color Picker	0-255	192
Green	Green level, Color Picker	0-255	192
Blue	Blue level, Color Picker	0-255	192
Alpha	Alpha level	0-255	255

▼ **Grid**



Adds a grid of any RGB color and alpha level to the layer texture. The following parameters can be adjusted as well: Amount, Softness, Size, Offset X&Y.

Parameter	Description	Value Range	Default
Mix	Level of Effect	0-255	0
Amount	Amount of grid segments	0-65535	1024
Softness	Softness of grid edges	0-65535	32
Size	Size of grid	0-65535	32768
Offset X	Horizontal Offset	0-65535	32768
Offset Y	Vertical Offset	0-65535	32768
Red	Red level, Color Picker	0-255	192

Green	Green level, Color Picker	0-255	192
Blue	Blue level, Color Picker	0-255	192
Alpha	Alpha level	0-255	255

▼ LED



Turns the layer texture into single LED spots. Amount, Softness, Size, Offset X&Y.

Parameter	Description	Value Range	Default
Mix	Level of Effect	0-255	0
Amount	Amount of LED spots	0-65535	8192
Circle	Shape of LED spots	0-65535	28000
Alpha	Alpha level of the gaps between the LED spots	0-255	0

▼ Lines Horizontal



Adds horizontal lines of any RGB color and alpha level to the layer texture. The following parameters can be adjusted as well: Amount, Softness, Size and the Offset.

Parameter	Description	Value Range	Default
Mix	Level of Effect	0-255	0
Amount	Amount of lines	0-65535	1024
Softness	Softness of line edges	0-65535	32
Size	Size of lines	0-65535	32768
Offset	Vertical Offset	0-65535	32768
Red	Red level, Color Picker	0-255	192
Green	Green level, Color Picker	0-255	192
Blue	Blue level, Color Picker	0-255	192
Alpha	Alpha level	0-255	255

▼ **Lines Vertical**



Adds vertical lines of any RGB color and alpha level to the layer texture. The following parameters can be adjusted as well: Amount, Softness, Size and the Offset.

Parameter	Description	Value Range	Default
Mix	Level of Effect	0-255	0
Amount	Amount of lines	0-65535	1024
Softness	Softness of line edges	0-65535	32
Size	Size of lines	0-65535	32768
Offset	Horizontal Offset	0-65535	32768
Red	Red level, Color Picker	0-255	0
Green	Green level, Color Picker	0-255	0
Blue	Blue level, Color Picker	0-255	0
Alpha	Alpha level	0-255	255

▼ **Pixels**



Turns the layer texture into a pattern of pixel dots. Threshold, amount and circularity can be adjusted, as well as color, brightness and alpha value.

Parameter	Description	Value Range	Default
Mix	Level of effect itself	0-255	0
Threshold	Threshold	0-255	128
Amount	Amount	0-65535	6000
Circle	Circle	0-65535	32768
Red	Color picker / Level of red	0-255	255
Green	Color picker / Level of green	0-255	255
Blue	Color picker / Level of blue	0-255	255
Alpha	Level of transparency	0-255	255
Level	Level	0-255	128

▼ Simple Outline

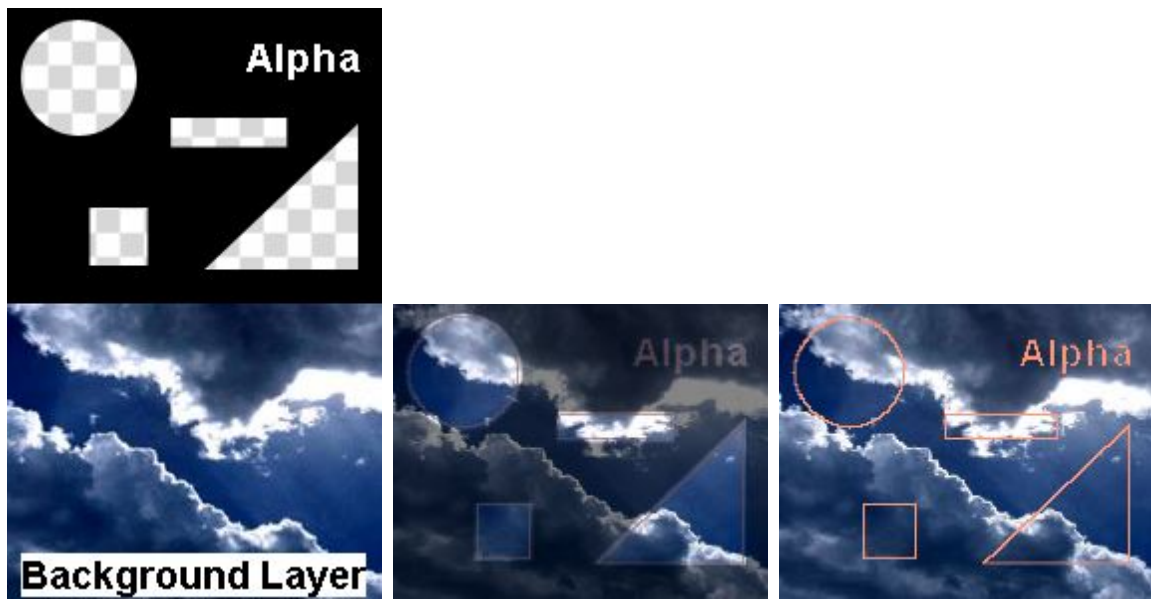

Adds a simple outline of any RGB color between transparent / non-transparent parts of the layer texture and removes the non-transparent parts of the file.

Parameter	Description	Value Range	Default
Mix	Level of Effect	0-255	0
Red	Red level, Color Picker	0-255	255
Green	Green level, Color Picker	0-255	255
Blue	Blue level, Color Picker	0-255	255

### 5.4.2.11.35 REMAP

► ReMap Overlay

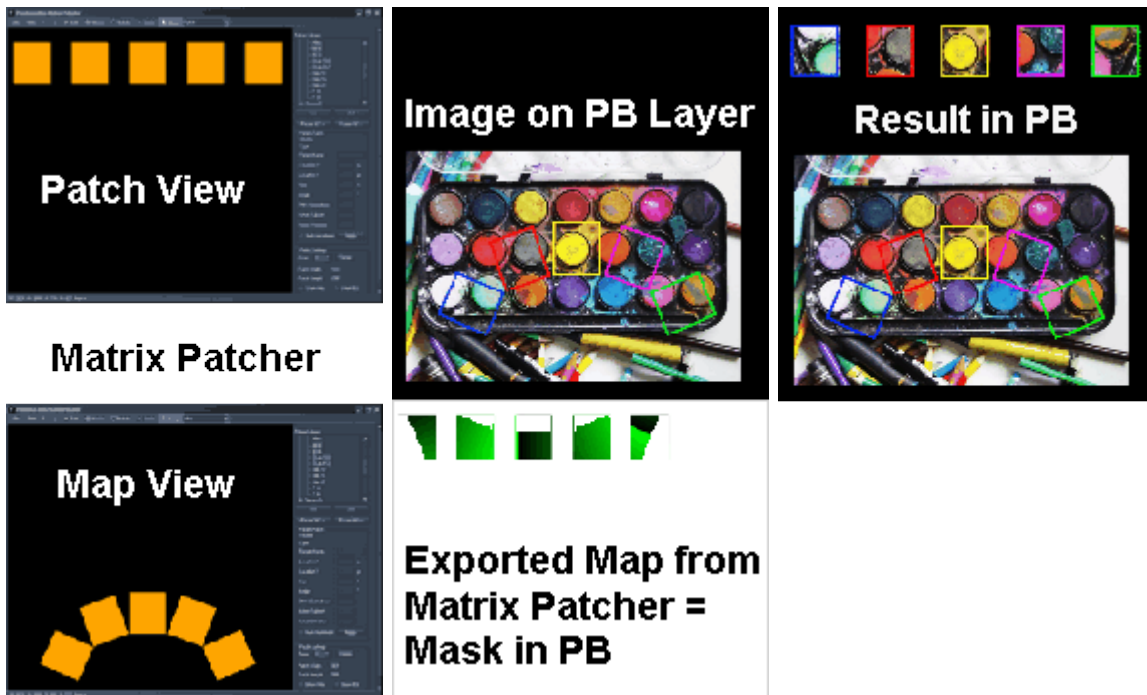

Reads the map exported from the [Matrix Patcher](#)<sup>757</sup> and routes automatically any source pixel to the stored output location. Thus it routes the pixels according to the Patch / Map View setup in the Matrix Patcher. The routed pixels overlay the original image.

Note that the effect has to be assigned to an output layer and is only visible in the preview if it is set to an output view, not the global camera.

Parameter	Description	Value Range	Default
Mix	Level of Effect	0-255	0
Media	Media File as Mask	0-255	255

► ReMap

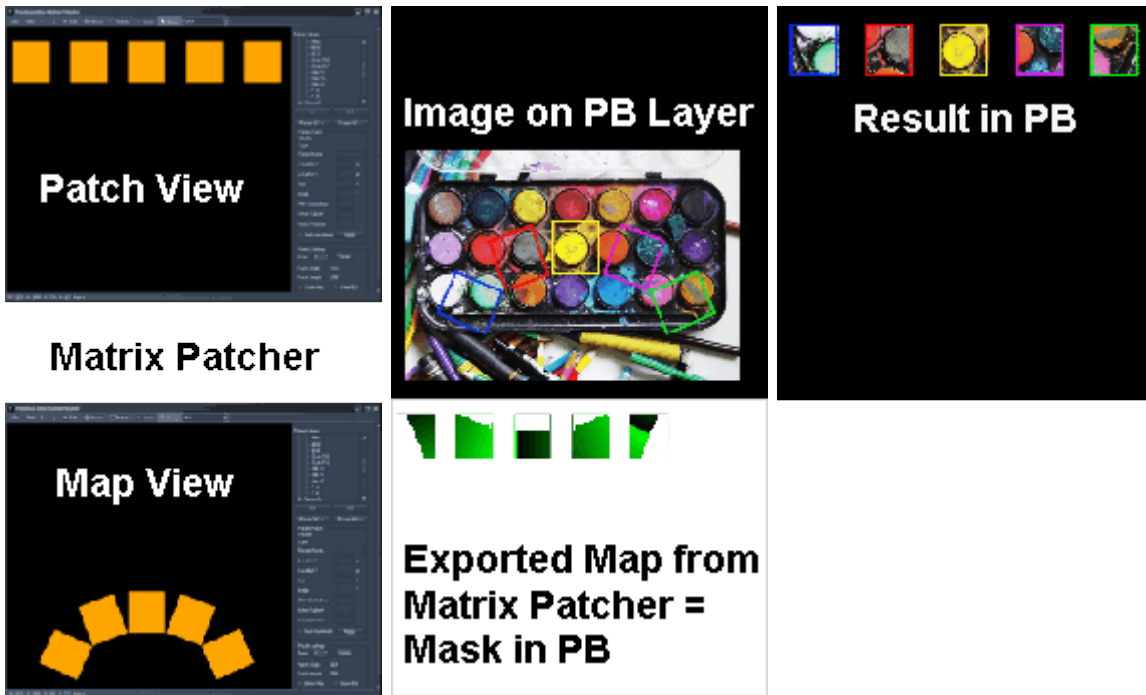

Reads the map exported from the [Matrix Patcher](#)<sup>757</sup> and routes automatically any source pixel to the stored output location. Thus it routes the pixels according to the Patch / Map View setup in the Matrix Patcher. Only the routed pixels are visible.

Note that the effect has to be assigned to an output layer and is only visible in the preview if it is set to an output view, not the global camera.

Parameter	Description	Value Range	Default
Mix	Level of Effect	0-255	0
Media	Media File as Mask	0-255	255

### 5.4.2.11.36 SHADOWS

#### ▼ Drop Shadow Alpha

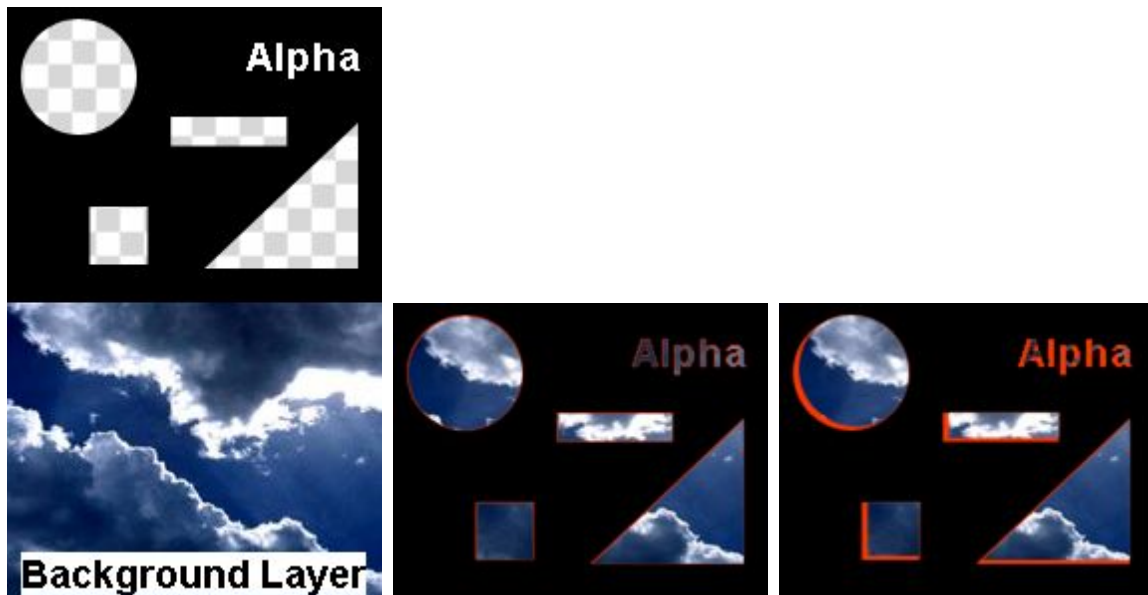

Adds a drop shadow at the transitions between transparent and non-transparent parts of the layer texture. The shadow's position, color and alpha value can be adjusted.

Parameter	Description	Value Range	Default
Mix	Level of Effect	0-255	0
X	X Position	0-65535	33280
Y	Y Position	0-65535	32000
Red	Red level, Color Picker	0-255	0
Green	Green level, Color Picker	0-255	0
Blue	Blue level, Color Picker	0-255	0
Alpha	Alpha level	0-255	128

### 5.4.2.11.37 SHAPES

#### ▼ Circle2D Mask



Adds a circular mask to the layer texture. The mask's color, alpha, size and radius value can be adjusted, as well as its position, the edge's softness and fill-behavior.

Parameter	Description	Value Range	Default
-----------	-------------	-------------	---------

Mix	Level of effect itself	0-255	0
Pt1 X	Horizontal position of the first point	0-65535	32768
Pt1 Y	Vertical position of the first point	0-65535	32768
Red	Color picker / Level of red	0-255	0
Green	Color picker / Level of green	0-255	0
Blue	Color picker / Level of blue	0-255	0
Alpha	Level of transparency	0-255	255
Softness	Softness	0-65535	2048
Size	Size	0-65535	1024
Radius	Radius	0-65535	16384
Fill	Fill	0-255	255

▼ Circle2D



Adds a circle to the layer texture. The circle's color, alpha, size and radius value can be adjusted, as well as its position, the edge's softness and fill-behavior.

Parameter	Description	Value Range	Default
Mix	Level of effect itself	0-255	0
Pt1 X	Horizontal position of the first point	0-65535	32768
Pt1 Y	Vertical position of the first point	0-65535	32768
Red	Color picker / Level of red	0-255	255
Green	Color picker / Level of green	0-255	255
Blue	Color picker / Level of blue	0-255	255
Alpha	Level of transparency	0-255	255
Softness	Softness	0-65535	128
Size	Size	0-65535	128
Radius	Radius	0-65535	8192
Fill	Fill	0-255	0



▼ Draw Point Alpha

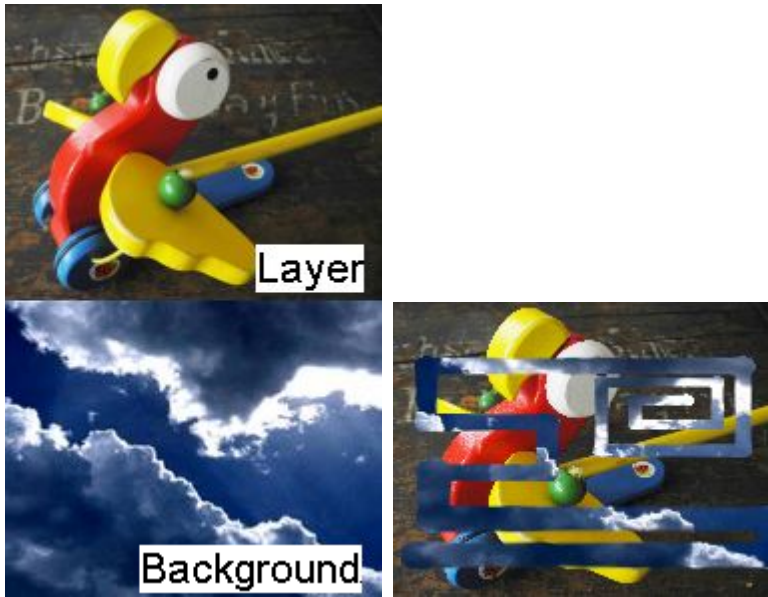

Adds a transparent line to the texture layer and reveals the underlying background. The line can be drawn manually by changing the X- and Y-value of the draw point. Size and pressure of the point can be adjusted. As long as the "Clear" parameter is set to 0, you can draw; switching to 1 clears the drawn line and covers the background again.

Parameter	Description	Value Range	Default
Mix	Level of effect itself	0-255	255
Clear	Clear	0-1	1
Size	Size	0-65535	32768
Pressure	Pressure	0-65535	32768
X	X	0-65535	32768
Y	Y	0-65535	32768

▼ Draw Point RGB



Overlays the layer texture with a line that can be drawn manually by changing the X- and Y-value of the draw point. Color, size and pressure of the point can be adjusted. As long as the "Clear" parameter is set to 0, you can draw; switching to 1 clears the drawn line.

Parameter	Description	Value Range	Default
Mix	Level of effect itself	0-255	255
Clear	Clear	0-1	1

Size	Size	0-65535	32768
Pressure	Pressure	0-65535	32768
X	X	0-65535	32768
Y	Y	0-65535	32768
Red	Color picker / Level of red	0-255	255
Green	Color picker / Level of green	0-255	255
Blue	Color picker / Level of blue	0-255	255

▼ **Ellipse2D Mask**



Adds an elliptic mask to the layer texture. The mask's height an width, color, alpha level and radius value can be adjusted, as well as its position, the edge's softness and fill-behavior.

Parameter	Description	Value Range	Default
Mix	Level of effect itself	0-255	0
Pt1 X	Horizontal position of the first point	0-65535	32768
Pt1 Y	Vertical position of the first point	0-65535	32768
Width	Width	0-65535	32768
Height	Height	0-65535	32768
Red	Color picker / Level of red	0-255	0
Green	Color picker / Level of green	0-255	0
Blue	Color picker / Level of blue	0-255	0
Alpha	Level of transparency	0-255	255
Softness	Softness	0-65535	16384
Size	Size	0-65535	2048
Fill	Fill	0-255	255

▼ **Ellipse2D**



Adds an elliptic circle to the layer texture. The circle's height an width, color, alpha and radius value can be adjusted, as well as its position, the edge's softness and fill-behavior.

Parameter	Description	Value Range	Default
Mix	Level of effect itself	0-255	0
Pt1 X	Horizontal position of the first point	0-65535	32768
Pt1 Y	Vertical position of the first point	0-65535	32768
Width	Width	0-65535	32768
Height	Height	0-65535	32768
Red	Color picker / Level of red	0-255	255
Green	Color picker / Level of green	0-255	255
Blue	Color picker / Level of blue	0-255	255
Alpha	Level of transparency	0-255	255
Softness	Softness	0-65535	1024
Size	Size	0-65535	2048
Fill	Fill	0-255	0

▼ EQ Media

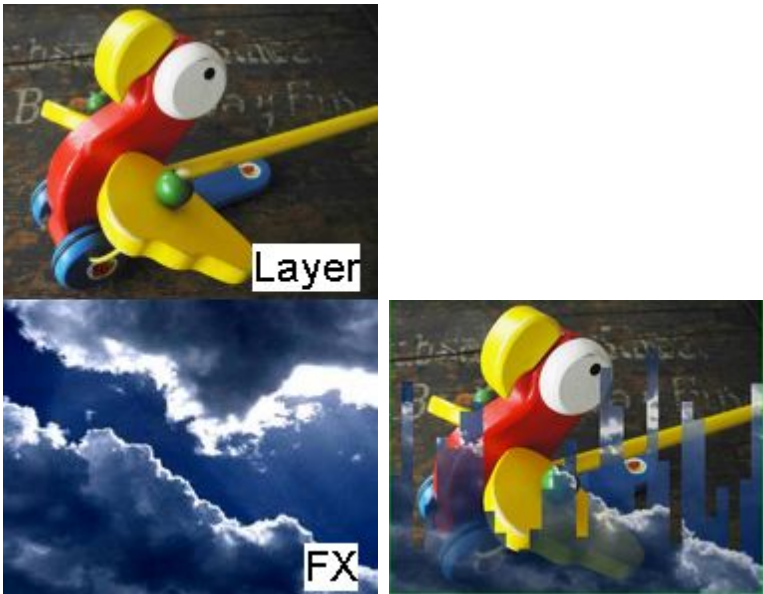

Adds 32 bars to the texture of the layer, the bars' texture layer is filled with selectable media content. Each bar's level can be adjusted, e.g. by programming values into the sequence or by receiving them from other programs, e.g. by the [Widget Designer's Audio Processor Input node](#)<sup>988</sup>.

Parameter	Description	Value Range	Default
Mix	Level of effect itself	0-255	0
Media	Media file as source for overlay or mask	-	-
EQ1	EQ1	0-65535	32768
EQ2	EQ2	0-65535	32768
EQ3	EQ3	0-65535	32768
EQ4	EQ4	0-65535	32768
EQ5	EQ5	0-65535	32768
EQ6	EQ6	0-65535	32768
EQ7	EQ7	0-65535	32768
EQ8	EQ8	0-65535	32768
EQ9	EQ9	0-65535	32768

EQ10	EQ10	0-65535	32768
EQ11	EQ11	0-65535	32768
EQ12	EQ12	0-65535	32768
EQ13	EQ13	0-65535	32768
EQ14	EQ14	0-65535	32768
EQ15	EQ15	0-65535	32768
EQ16	EQ16	0-65535	32768
EQ17	EQ17	0-65535	32768
EQ18	EQ18	0-65535	32768
EQ19	EQ19	0-65535	32768
EQ20	EQ20	0-65535	32768
EQ21	EQ21	0-65535	32768
EQ22	EQ22	0-65535	32768
EQ23	EQ23	0-65535	32768
EQ24	EQ24	0-65535	32768
EQ25	EQ25	0-65535	32768
EQ26	EQ26	0-65535	32768
EQ27	EQ27	0-65535	32768
EQ28	EQ28	0-65535	32768
EQ29	EQ29	0-65535	32768
EQ30	EQ30	0-65535	32768
EQ31	EQ31	0-65535	32768
EQ32	EQ32	0-65535	32768

▼ EQ Waveform



Turns the texture of the layer into a dynamic shape with hundreds of equalizer bars. The level of each bar is automatically adjusted by the [Widget Designer's Audio Processor Input node](#)<sup>988</sup>. A high "Glow" parameter adds a fading overlay to the bars (2nd img.). The parameter "Alpha" influences the background of the bars and blends between black and transparent, displaying underlying layers. The parameter "Blend" colors the bars: 0 = white, 255 = layer texture (3rd img.).

Parameter	Description	Value Range	Default
Mix	Level of effect itself	0-255	0
Glow	Glow	0-255	255
Alpha	Level of transparency	0-255	0
Blend	Blend	0-255	0

▼ EQ



Adds 32 rainbow colored equalizer bars to the texture of the layer. Each bar's level can be adjusted e.g. by programming values into the sequence or by receiving them from other programs, e.g by the [Widget Designer's Audio Processor Input node](#)<sup>988</sup>.

Parameter	Description	Value Range	Default
Mix	Level of effect itself	0-255	0
EQ1	EQ1	0-65535	32768
EQ2	EQ2	0-65535	32768
EQ3	EQ3	0-65535	32768
EQ4	EQ4	0-65535	32768
EQ5	EQ5	0-65535	32768
EQ6	EQ6	0-65535	32768
EQ7	EQ7	0-65535	32768
EQ8	EQ8	0-65535	32768
EQ9	EQ9	0-65535	32768
EQ10	EQ10	0-65535	32768
EQ11	EQ11	0-65535	32768
EQ12	EQ12	0-65535	32768
EQ13	EQ13	0-65535	32768
EQ14	EQ14	0-65535	32768
EQ15	EQ15	0-65535	32768
EQ16	EQ16	0-65535	32768
EQ17	EQ17	0-65535	32768
EQ18	EQ18	0-65535	32768
EQ19	EQ19	0-65535	32768
EQ20	EQ20	0-65535	32768
EQ21	EQ21	0-65535	32768
EQ22	EQ22	0-65535	32768
EQ23	EQ23	0-65535	32768
EQ24	EQ24	0-65535	32768
EQ25	EQ25	0-65535	32768
EQ26	EQ26	0-65535	32768
EQ27	EQ27	0-65535	32768
EQ28	EQ28	0-65535	32768
EQ29	EQ29	0-65535	32768
EQ30	EQ30	0-65535	32768
EQ31	EQ31	0-65535	32768
EQ32	EQ32	0-65535	32768

▼ Line Horizontal



Adds a horizontal line to the layer texture. The line's position, color, width and alpha value can be adjusted.

Parameter	Description	Value Range	Default
Mix	Level of Effect	0-255	0
V Pos	Vertical Position	0-65535	32768
H Start	Start of Line Horizontal	0-65535	0
H End	End of Line Horizontal	0-65535	65535
Red	Red level, Color Picker	0-255	255
Green	Green level, Color Picker	0-255	255
Blue	Blue level, Color Picker	0-255	255
Alpha	Alpha level	0-255	255
Width	Width of line	0-65535	2048

▼ Line Vertical



Adds a vertical line to the layer texture. The line's position, color, width and alpha value can be adjusted.

Parameter	Description	Value Range	Default
Mix	Level of Effect	0-255	0
V Pos	Vertical Position	0-65535	32768
V Start	Start of Line Vertical	0-65535	0
V End	End of Line Vertical	0-65535	65535
Red	Red level, Color Picker	0-255	255
Green	Green level, Color Picker	0-255	255
Blue	Blue level, Color Picker	0-255	255
Alpha	Alpha level	0-255	255
Width	Width of line	0-65535	2048

▼ **Line2D Mask**

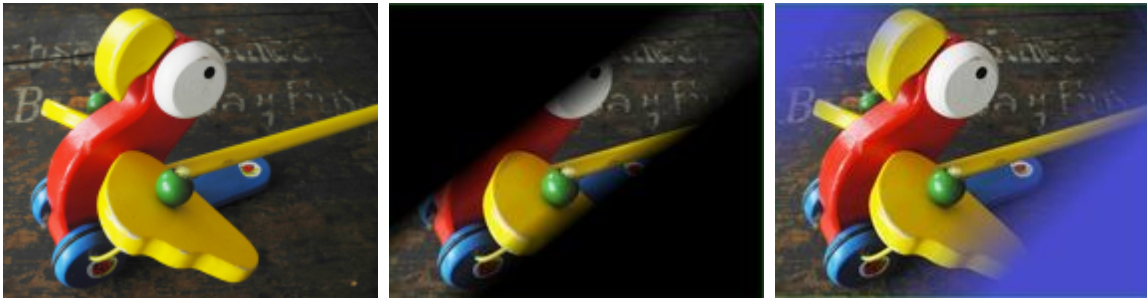

Adds a line shaped mask to the layer texture. The mask's endpoints, color, alpha level and size can be adjusted, as well as the edge's softness.

Parameter	Description	Value Range	Default
Mix	Level of effect itself	0-255	0
Pt1 X	Horizontal position of the first point	0-65535	0
Pt1 Y	Vertical position of the first point	0-65535	0
Pt2 X	Horizontal position of the second point	0-65535	65535
Pt2 Y	Vertical position of the second point	0-65535	65535
Red	Color picker / Level of red	0-255	0
Green	Color picker / Level of green	0-255	0
Blue	Color picker / Level of blue	0-255	0
Alpha	Level of transparency	0-255	255
Softness	Softness	0-65535	250
Size	Size	0-65535	250

▼ **Line2D**

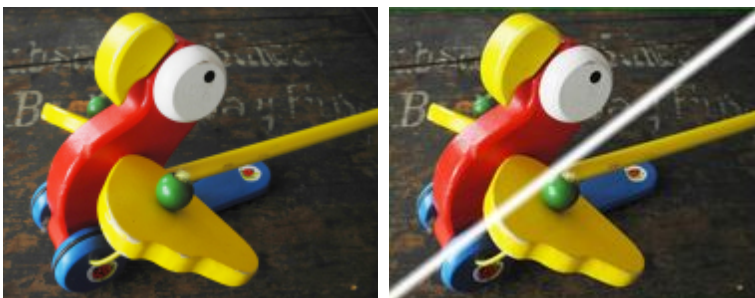

Adds a line to the layer texture. The line's endpoints, color, alpha level and size can be adjusted, as well as the edge's softness.

Parameter	Description	Value Range	Default
Mix	Level of effect itself	0-255	0
Pt1 X	Horizontal position of the first point	0-65535	0
Pt1 Y	Vertical position of the first point	0-65535	0
Pt2 X	Horizontal position of the second point	0-65535	65535
Pt2 Y	Vertical position of the second point	0-65535	65535
Red	Color picker / Level of red	0-255	255

Green	Color picker / Level of green	0-255	255
Blue	Color picker / Level of blue	0-255	255
Alpha	Level of transparency	0-255	255
Softness	Softness	0-65535	250
Size	Size	0-65535	250

▼ **MetaBall2D Add**



Adds two glowing balls to the layer texture and dims the rest of it. The position and color of each ball can be adjusted separately, the alpha level, blend, softness and size can be adjusted for both together.

Parameter	Description	Value Range	Default
Mix	Level of effect itself	0-255	0
Pt1 X	Horizontal position of the first point	0-65535	25000
Pt1 Y	Vertical position of the first point	0-65535	25000
Pt2 X	Horizontal position of the second point	0-65535	40000
Pt2 Y	Vertical position of the second point	0-65535	40000
Red1	First color picker / Level of red	0-255	255
Green1	First color picker / Level of green	0-255	100
Blue1	First color picker / Level of blue	0-255	0
Red2	Second color picker / Level of red	0-255	0
Green2	Second color picker / Level of green	0-255	100
Blue2	Second color picker / Level of blue	0-255	255
Alpha	Level of transparency	0-255	255
Blend	Blend	0-255	0
Softness	Softness	0-65535	16384
Size	Size	0-65535	16384



▼ **MetaBall2D Multiply**



Adds two glowing balls to the layer texture whose halos are multiplied and dims the rest of it. The position and color of each ball can be adjusted separately, the alpha level, blend, softness and weight can be adjusted for both together.

Parameter	Description	Value Range	Default
Mix	Level of effect itself	0-255	0
Pt1 X	Horizontal position of the first point	0-65535	25000
Pt1 Y	Vertical position of the first point	0-65535	25000
Pt2 X	Horizontal position of the second point	0-65535	40000
Pt2 Y	Vertical position of the second point	0-65535	40000
Red1	First color picker / Level of red	0-255	255
Green1	First color picker / Level of green	0-255	128
Blue1	First color picker / Level of blue	0-255	0
Red2	Second color picker / Level of red	0-255	0
Green2	Second color picker / Level of green	0-255	128
Blue2	Second color picker / Level of blue	0-255	255
Alpha	Level of transparency	0-255	255
Blend	Blend	0-255	0
Softness1	Softness1	0-65535	16384
Weight	Weight	0-65535	32768

▼ **MetaBall2D Outline Glow**



Two black balls with glowing outlines are added to the layer texture and the rest of it is dimmed. The position of each ball can be adjusted separately, the alpha level, blend, softness and size as well as color and radius can be adjusted for both together.

Parameter	Description	Value Range	Default
Mix	Level of effect itself	0-255	0

Pt1 X	Horizontal position of the first point	0-65535	25000
Pt1 Y	Vertical position of the first point	0-65535	25000
Pt2 X	Horizontal position of the second point	0-65535	40000
Pt2 Y	Vertical position of the second point	0-65535	40000
Red	Color picker / Level of red	0-255	128
Green	Color picker / Level of green	0-255	196
Blue	Color picker / Level of blue	0-255	255
Alpha	Level of transparency	0-255	255
Blend	Blend	0-255	0
Glow	Glow	0-65535	32768
Radius	Radius	0-65535	8192
Size	Size	0-65535	62000

▼ **Quad 16bit**



Adds a quadrangle (four-sided figure) shape to the layer texture. The corner positions and the inside color and alpha level can be adjusted, as well as the softness of each edge.

This effect can be used for [blacklevel adjustment](#)<sup>613</sup>, when it is assigned to the output or to a layer that is toggled into the [Output Rendering Pass](#)<sup>297</sup> by using the [Layer Inspector](#)<sup>208</sup>.

Parameter	Description	Value Range	Default
Mix	Level of effect itself	0-255	0
Pt1 X	Horizontal position of the first point	0-65535	0
Pt1 Y	Vertical position of the first point	0-65535	65535
Softness 1	Softness 1	0-65535	250
Pt2 X	Horizontal position of the second point	0-65535	65535
Pt2 Y	Vertical position of the second point	0-65535	65535
Softness 2	Softness 2	0-65535	250
Pt3 X	Horizontal position of the third point	0-65535	65535
Pt3 Y	Vertical position of the third point	0-65535	0
Softness 3	Softness 3	0-65535	250
Pt4 X	Horizontal position of the fourth point	0-65535	0
Pt4 Y	Vertical position of the fourth point	0-65535	0
Softness 4	Softness 4	0-65535	250
Red	Color picker / Level of red	0-65535	65535
Green	Color picker / Level of green	0-65535	65535
Blue	Color picker / Level of blue	0-65535	65535

Alpha	Level of transparency	0-65535	65535
-------	-----------------------	---------	-------

### ▼ Quad Black Lift 16bit



Adds a quadrangle (four-sided figure) shape to the layer texture. The corner positions and the inside color and alpha level can be adjusted, as well as the softness of each edge.

The shape color is added to the layer texture but only to dark values. The higher the "Threshold" parameter the lighter the colors get that are influenced by the shape.

This effect can be used for [blacklevel adjustment](#)<sup>613</sup>, when it is assigned to the output or to a layer that is toggled into the [Output Rendering Pass](#)<sup>297</sup> by using the [Layer Inspector](#)<sup>208</sup>.

Parameter	Description	Value Range	Default
Mix	Level of effect itself	0-255	0
Pt1 X	Horizontal position of the first point	0-65535	0
Pt1 Y	Vertical position of the first point	0-65535	65535
Softness 1	Softness 1	0-65535	0
Pt2 X	Horizontal position of the second point	0-65535	65535
Pt2 Y	Vertical position of the second point	0-65535	65535
Softness 2	Softness 2	0-65535	0
Pt3 X	Horizontal position of the third point	0-65535	65535
Pt3 Y	Vertical position of the third point	0-65535	0
Softness 3	Softness 3	0-65535	0
Pt4 X	Horizontal position of the fourth point	0-65535	0
Pt4 Y	Vertical position of the fourth point	0-65535	0
Softness 4	Softness 4	0-65535	0
Red	Color picker / Level of red	0-65535	10000
Green	Color picker / Level of green	0-65535	10000
Blue	Color picker / Level of blue	0-65535	10000
Alpha	Level of transparency	0-65535	65535
Threshold	Threshold	0-65535	30000

▼ Quad2D Mask



Adds a quadrangle (four-sided figure) shaped mask to the layer texture. The corner positions, mask color and alpha level can be adjusted, as well as the softness, size and fill-behavior of the mask.

Parameter	Description	Value Range	Default
Mix	Level of effect itself	0-255	0
Pt1 X	Horizontal position of the first point	0-65535	4096
Pt1 Y	Vertical position of the first point	0-65535	61439
Pt2 X	Horizontal position of the second point	0-65535	61439
Pt2 Y	Vertical position of the second point	0-65535	61439
Pt3 X	Horizontal position of the third point	0-65535	61439
Pt3 Y	Vertical position of the third point	0-65535	4096
Pt4 X	Horizontal position of the fourth point	0-65535	4096
Pt4 Y	Vertical position of the fourth point	0-65535	4096
Red	Color picker / Level of red	0-255	0
Green	Color picker / Level of green	0-255	0
Blue	Color picker / Level of blue	0-255	0
Alpha	Level of transparency	0-255	255
Softness	Softness	0-65535	1024
Size	Size	0-65535	0
Fill	Fill	0-255	255

▼ Quad2D



Adds a quadrangle (four-sided figure) shape to the layer texture. The corner positions, mask color and alpha level can be adjusted, as well as the softness, size and fill-behavior of the shape.

Parameter	Description	Value Range	Default
Mix	Level of effect itself	0-255	0

Pt1 X	Horizontal position of the first point	0-65535	0
Pt1 Y	Vertical position of the first point	0-65535	65535
Pt2 X	Horizontal position of the second point	0-65535	65535
Pt2 Y	Vertical position of the second point	0-65535	65535
Pt3 X	Horizontal position of the third point	0-65535	65535
Pt3 Y	Vertical position of the third point	0-65535	0
Pt4 X	Horizontal position of the fourth point	0-65535	0
Pt4 Y	Vertical position of the fourth point	0-65535	0
Red	Color picker / Level of red	0-255	255
Green	Color picker / Level of green	0-255	255
Blue	Color picker / Level of blue	0-255	255
Alpha	Level of transparency	0-255	255
Softness	Softness	0-65535	250
Size	Size	0-65535	250
Fill	Fill	0-255	255

▼ **Rectangle**

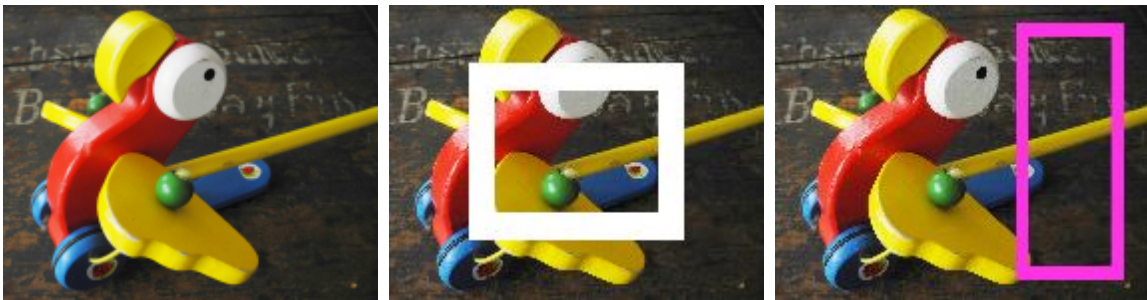

Adds an outline of a rectangle to the layer texture. The rectangle's position, color, width and alpha value can be adjusted.

Parameter	Description	Value Range	Default
Mix	Level of Effect	0-255	0
Pos U	Horizontal Position	0-65535	32768
Pos V	Vertical Position	0-65535	32768
Width	Width of the rectangle	0-65535	32768
Height	Height of the rectangle	0-65535	32768
Red	Red level, Color Picker	0-255	255
Green	Green level, Color Picker	0-255	255
Blue	Blue level, Color Picker	0-255	255
Alpha	Alpha level	0-255	255
Size	Thickness of the rectangle's lines	0-65535	1024

▼ **Rectangle2D Mask**



Adds a rectangular mask to the layer of the texture. Its size and position as well as color, alpha and fill level, edge softness, and the angle of the mask can be adjusted.

Parameter	Description	Value Range	Default
Mix	Level of effect itself	0-255	0
Pos U	Horizontal position	0-65535	32768
Pos V	Vertical position	0-65535	32768
Width	Width	0-65535	32768
Height	Height	0-65535	32768
Red	Color picker / Level of red	0-255	255
Green	Color picker / Level of green	0-255	255
Blue	Color picker / Level of blue	0-255	255
Alpha	Level of transparency	0-255	255
Size	Size	0-65535	1024
Softness	Softness	0-65535	1024
Fill	Fill	0-255	255
Angle	Angle	0-360	180

▼ **Rectangle2D**

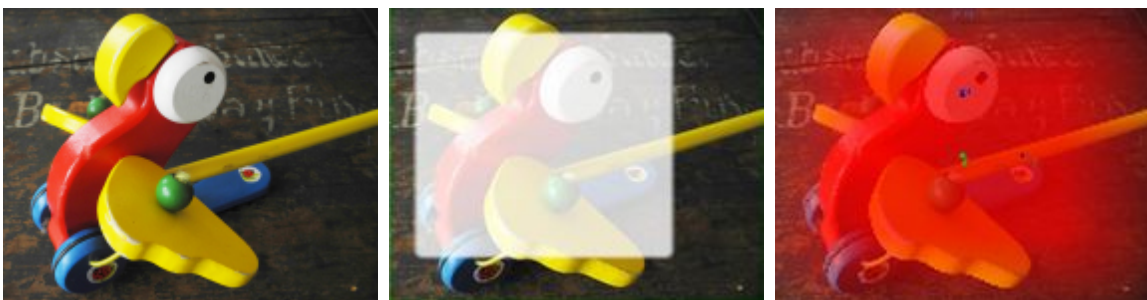

Adds a rectangle to the layer of the texture. Its size and position as well as color, alpha and fill level, edge softness, and the angle of the shape can be adjusted.

Parameter	Description	Value Range	Default
Mix	Level of effect itself	0-255	0
Pos U	Horizontal position	0-65535	32768
Pos V	Vertical position	0-65535	32768
Width	Width	0-65535	32768
Height	Height	0-65535	32768

Red	Color picker / Level of red	0-255	255
Green	Color picker / Level of green	0-255	255
Blue	Color picker / Level of blue	0-255	255
Alpha	Level of transparency	0-255	255
Size	Size	0-65535	1024
Softness	Softness	0-65535	1024
Fill	Fill	0-255	255
Angle	Angle	0-360	180

▼ **Triangle2D Mask**

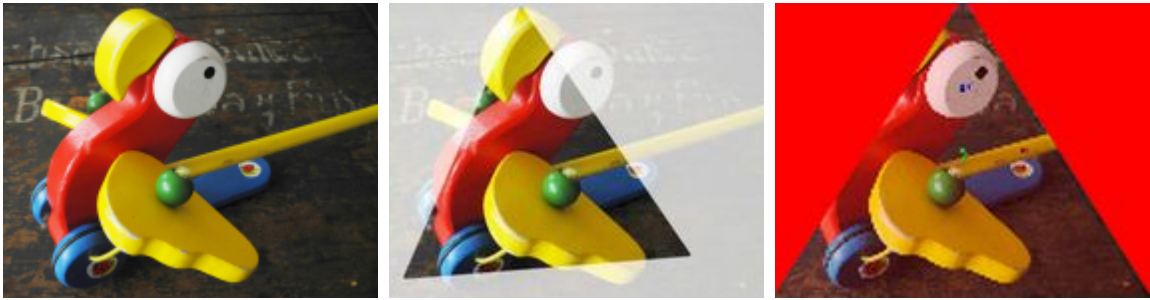

Adds a triangular mask to the layer of the texture. Its size and position as well as color, alpha and fill level, edge softness, and the angle of the mask can be adjusted.

Parameter	Description	Value Range	Default
Mix	Level of effect itself	0-255	0
Pt1 X	Horizontal position of the first point	0-65535	0
Pt1 Y	Vertical position of the first point	0-65535	0
Pt2 X	Horizontal position of the second point	0-65535	32768
Pt2 Y	Vertical position of the second point	0-65535	65535
Pt3 X	Horizontal position of the third point	0-65535	65535
Pt3 Y	Vertical position of the third point	0-65535	0
Red	Color picker / Level of red	0-255	255
Green	Color picker / Level of green	0-255	255
Blue	Color picker / Level of blue	0-255	255
Alpha	Level of transparency	0-255	255
Softness	Softness	0-65535	250
Size	Size	0-65535	250
Fill	Fill	0-255	255
Angle	Angle	0-360	180

▼ Triangle2D



Adds a triangle to the layer of the texture. Its size and position as well as color, alpha and fill level, edge softness, and the angle of the shape can be adjusted.

Parameter	Description	Value Range	Default
Mix	Level of effect itself	0-255	0
Pt1 X	Horizontal position of the first point	0-65535	0
Pt1 Y	Vertical position of the first point	0-65535	0
Pt2 X	Horizontal position of the second point	0-65535	32768
Pt2 Y	Vertical position of the second point	0-65535	65535
Pt3 X	Horizontal position of the third point	0-65535	65535
Pt3 Y	Vertical position of the third point	0-65535	0
Red	Color picker / Level of red	0-255	255
Green	Color picker / Level of green	0-255	255
Blue	Color picker / Level of blue	0-255	255
Alpha	Level of transparency	0-255	255
Softness	Softness	0-65535	250
Size	Size	0-65535	250
Fill	Fill	0-255	255
Angle	Angle	0-360	180

5.4.2.11.38 SHARPEN

▼ Edges



Sharpens the layer texture on all edges. The effect generates three additional textures with black and white edges. These textures then overlay the real layer. With the parameters "Width" and "Height" you can influence the horizontal and vertical offset of these textures / edges.

Parameter	Description	Value Range	Default
-----------	-------------	-------------	---------



Mix	Level of Effect	0-255	0
Width	Amount of sharpening	0-255	128
Height	Offset factor	0-255	128

▼ **Outlines**

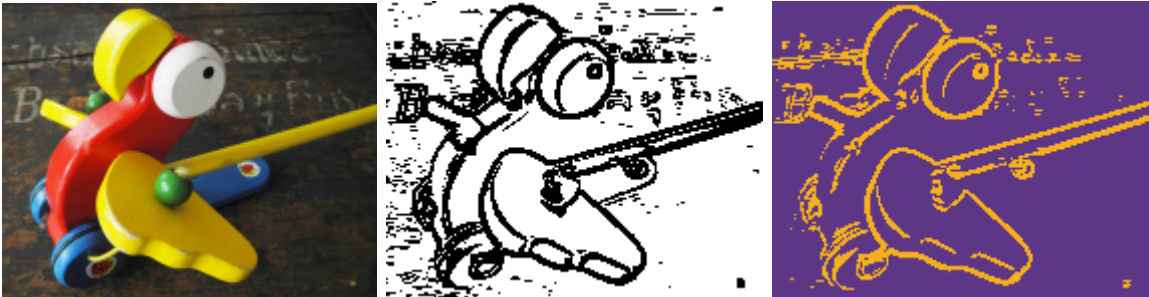

Creates area outlines of the layer texture by separating the texture into two different groups. This depends on the contrast level of adjacent pixels, which can be adjusted with the parameter "threshold".

You can setup a color and alpha level for both areas.

Parameter	Description	Value Range	Default
Mix	Level of Effect	0-255	0
Red H	Red level of High Color, Color Picker	0-255	255
Green H	Green level, Color Picker	0-255	255
Blue H	Blue level of High Color, Color Picker	0-255	255
Alpha H	Alpha level of High Color	0-255	255
Red L	Red level of Low Color, Color Picker	0-255	0
Green L	Green level of Low Color, Color Picker	0-255	0
Blue L	Blue level of Low Color, Color Picker	0-255	0
Alpha L	Alpha level of Low Color	0-255	255
Threshold	Threshold	0-255	32

▼ **Sharpen Alpha Edges (Fill Color)**



Sharpens the edges of the alpha (transparent) channel depending on the chosen threshold and smoothing value. In addition, all non-transparent pixels, can be colored in.

Parameter	Description	Value Range	Default
Mix	Level of effect itself	0-255	0
Threshold	Threshold	0-255	128
Smoothing	Smoothing	0-255	128
Red	Color picker / Level of red	0-255	255

Green	Color picker / Level of green	0-255	255
Blue	Color picker / Level of blue	0-255	255

▼ **Sharpen Alpha Edges**

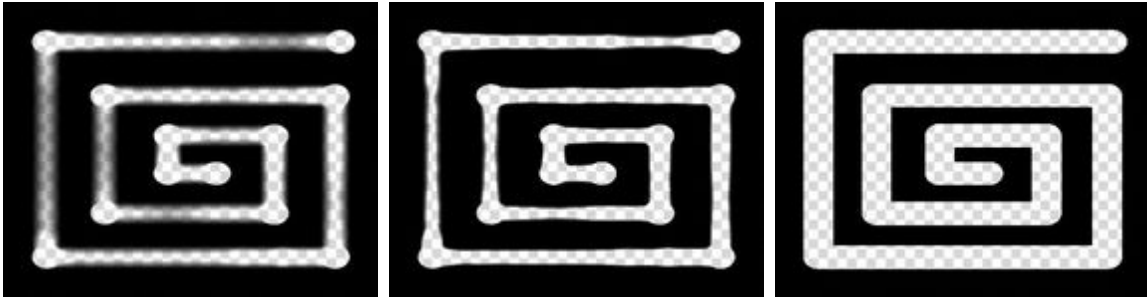

Sharpens the edges of the alpha (transparent) channel depending on the chosen threshold and smoothing value.

Parameter	Description	Value Range	Default
Mix	Level of effect itself	0-255	0
Threshold	Threshold	0-255	128
Smoothing	Smoothing	0-255	128

▼ **Sharpen**



Sharpens the layer texture on all edges. You can influence the amount of sharpening as well as the offset factor for an internal sharpening texture.

Parameter	Description	Value Range	Default
Mix	Level of Effect	0-255	0
Amount	Amount of sharpening	0-255	255
Factor	Offset factor	0-255	64

### 5.4.2.11.39 SNAPSHOT

#### ▼ Render Feedback



The texture is replaced by the Renderhistory (see [description in Composition FX](#))<sup>386</sup> creating a video feedback. This is similar to the situation when a mirror mirrors another mirror and the picture feedbacks itself again and again.

Parameter	Description	Value Range	Default
Mix	Level of Effect	0-255	0
Size	Size	0-65535	32768
Off U	Texture Offset in X	0-65535	32768
Off V	Texture Offset in Y	0-65535	32768
Add Factor	Add Factor	0-65535	32768
Del Factor	Del Factor	0-65535	0

#### ▼ Render Freeze

Allows freezing the Renderhistory, (see [description in Composition FX](#))<sup>386</sup>.

Parameter	Description	Value Range	Default
Mix	Level of Effect	0-255	0
Fade	Fade	0-255	255
Freeze	Freeze	0-255	30

#### ▼ Video Freeze

Shows a freeze frame of the video playing on the layer as soon as “Freeze” is set to a value >0. Meanwhile the playback is going on, so this is different from having the video paused.

Parameter	Description	Value Range	Default
Mix	Level of Effect	0-255	0
Freeze	Freezes the video	0-255	0

### 5.4.2.11.40 SOFTEDGE

#### ▼ Alpha Softedge



Allows setting a softedge fading into alpha for each edge: left, right, top and bottom. The amount and alpha curve of the softedge can be adjusted, markers for each softedge can help doing the setup.

Parameter	Description	Value Range	Default
Mix	Level of Effect	0-255	0
Left	Amount of Softedge left	0-65535	0
Left Alpha	Alpha curve	0-65535	32768
Left Marker	Marker for left softedge: 0=no marker 1 - 255 = black marker - white marker	0-255	0
L Width	Width of left marker	0-255	32

The parameters Left, Left Alpha, Left Marker and L Width and its values will be repeated for each corresponding edge: Right, Top and Bottom.

#### ▼ RGB Softedge

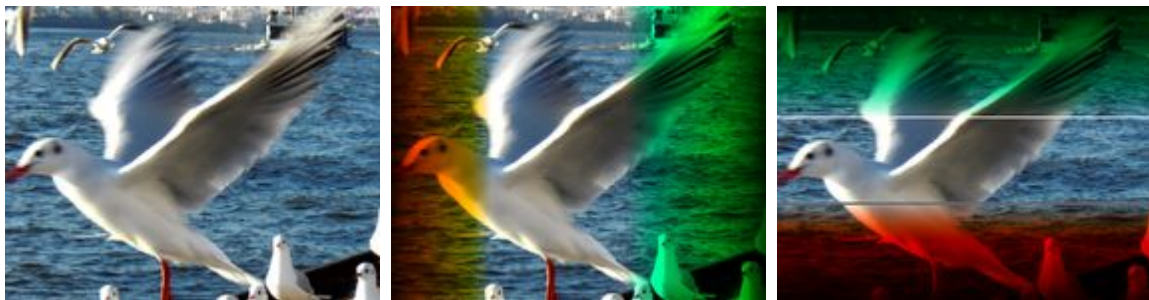

Allows setting a softedge fading into any RGB color for each edge: left, right, top and bottom. The amount and RGB curve of the softedge can be adjusted, markers for each softedge may help doing the setup.

Parameter	Description	Value Range	Default
Mix	Level of Effect	0-255	0
Left	Amount of Softedge left	0-65535	0
Left Red	Red curve	0-65535	32768
Left Green	Green curve	0-65535	32768
Left Blue	Blue curve	0-65535	32768
Left Marker	Marker for left softedge: 0=no marker 1 - 255 = black marker - white marker	0-255	0

L Width	Width of left marker	0-255	32
The parameters Left, Left Red/Green/Blue, Left Marker and L Width and its values will be repeated for each corresponding edge: Right, Top and Bottom.			

▼ **Softedge Bottom Alpha**



Allows setting a softedge fading into alpha for the bottom edge. The amount and alpha curve of the softedge can be adjusted, a marker for the softedge may help doing the setup.

Parameter	Description	Value Range	Default
Mix	Level of Effect	0-255	0
Amt	Amount of Softedge	0-65535	0
Curve	Red curve	0-65535	32768
Marker	Marker for softedge: 0=no marker 1 - 255 = green marker	0-255	0
Width	Width of marker	0-255	32

▼ **Softedge Bottom RGB**



Allows setting a softedge fading into any RGB for the bottom edge. The amount and RGB curve of the softedge can be adjusted, a marker for the softedge may help doing the setup.

Parameter	Description	Value Range	Default
Mix	Level of Effect	0-255	0
Amt	Amount of Softedge	0-65535	0
Curve	Red curve	0-65535	32768
Marker	Marker for softedge: 0=no marker 1 - 255 = green marker	0-255	0
Width	Width of marker	0-255	32

▼ **Softedge Left Alpha**

see FX [Softedge Bottom Alpha](#)<sup>549</sup>

▼ **Softedge Left RGB**

see FX [Softedge Bottom RGB](#)<sup>549</sup>

▼ **Softedge Right Alpha**

see FX [Softedge Bottom Alpha](#)<sup>549</sup>

▼ **Softedge Right RGB**

see FX [Softedge Bottom RGB](#)<sup>549</sup>

▼ **Softedge Top Alpha**

see FX [Softedge Bottom Alpha](#)<sup>549</sup>

▼ **Softedge Top RGB**

see FX [Softedge Bottom RGB](#)<sup>549</sup>

**5.4.2.11.41 SOFTEDGE - SOFTEDGE P-CURVE ALPHA**

▼ **Alpha Softedge P-Curve**



Allows setting a p-curve softedge fading into alpha for each edge: left, right, top and bottom. Position, curve and offset of each softedge can be adjusted, markers can help doing the setup.

Parameter	Description	Value Range	Default
Mix	Level of effect itself	0-255	0
Left	Amount of left softedge	0-65535	0
L Curve	Left alpha curve	0-65535	32768
L Offset	Left offset	0-65535	32768
L Marker	Left marker	0-255	0
L Width	Width of left marker	0-255	32

These parameters and its values are repeated for each corresponding edge: Right, Top and Bottom.

#### ▼ Softedge P-Curve Bottom Alpha



Allows setting a p-curve softedge fading into alpha for only one edge: bottom. Amount, curve and offset of the edge can be adjusted, a marker can help doing the setup.

Parameter	Description	Value Range	Default
Mix	Level of effect itself	0-255	0
Amount	Amount of softedge	0-65535	0
Curve	Curve	0-65535	32768
Offset	Offset	0-65535	32768
Marker	Marker	0-255	0
Width	Marker width	0-255	32

#### ▼ Softedge P-Curve Left Alpha

see FX [Softedge P-Curve Bottom Alpha](#)<sup>551</sup>

#### ▼ Softedge P-Curve Right Alpha

see FX [Softedge P-Curve Bottom Alpha](#)<sup>551</sup>

#### ▼ Softedge P-Curve Top Alpha

see FX [Softedge P-Curve Bottom Alpha](#)<sup>551</sup>

### 5.4.2.11.42 SOFTEDGE - SOFTEDGE P-CURVE ALPHA GAMMA

#### ▼ Alpha Softedge P-Curve Gamma



Allows setting a p-curve softedge fading into alpha for each edge: left, right, top and bottom. Position, curve and offset of each softedge can be adjusted, markers can help doing the setup. A color correction can be added via an RGB-gamma.

Parameter	Description	Value Range	Default
Mix	Level of effect itself	0-255	0
Left	Amount of left softedge	0-65535	0
L Curve	Left alpha curve	0-65535	32768
L Offset	Left offset	0-65535	32768
L Marker	Left marker	0-255	0
L Width	Width of left marker	0-255	32
These parameters and its values are repeated for each corresponding edge: Right, Top and Bottom.			
Gamma R	Gamma Red	0-65535	16384
Gamma G	Gamma Green	0-65535	16384
Gamma B	Gamma Blue	0-65535	16384

#### ▼ Softedge P-Curve Gamma Bottom Alpha



Allows setting a p-curve softedge fading into alpha for only one edge: Bottom. Position, curve and offset of each softedge can be adjusted, markers can help doing the setup. A color correction can be added via an RGB-gamma.

Parameter	Description	Value Range	Default
Mix	Level of effect itself	0-255	0
Amount	Amount of softedge	0-65535	0
Curve	Softedge curve	0-65535	16384
Offset	Offset	0-65535	32768



Marker	Marker	0-255	0
Width	Marker width	0-255	32
Gamma R	Gamma Red	0-65535	16384
Gamma G	Gamma Green	0-65535	16384
Gamma B	Gamma Blue	0-65535	16384

▼ **Softedge P-Curve Gamma Left Alpha**

see FX [Softedge P-Curve Gamma Bottom Alpha](#)<sup>552</sup>

▼ **Softedge P-Curve Gamma Right Alpha**

see FX [Softedge P-Curve Gamma Bottom Alpha](#)<sup>552</sup>

▼ **Softedge P-Curve Gamma Top Alpha**

see FX [Softedge P-Curve Gamma Bottom Alpha](#)<sup>552</sup>

**5.4.2.11.43 STROBE**

▼ **Alpha Flash**



Flashes a transparent alpha layer into the selected texture layer, the speed can be adjusted. The cross-fade between both texture is regular and the in-fade of the transparent texture has the same duration as the out-fade.

Parameter	Description	Value Range	Default
Mix	Level of effect itself	0-255	0
Flash Speed	Flash Speed	0-65535	32768

▼ Alpha Pulse



Pulses a transparent alpha layer into the selected texture layer, the speed can be adjusted. The cross-fade between both texture is irregular as the in-fade of the transparent texture is sudden whilst the out-fade is smooth.

Parameter	Description	Value Range	Default
Mix	Level of effect itself	0-255	0
Flash Speed	Flash Speed	0-65535	32768

▼ RND Alpha Flash



Flashes a transparent alpha layer into the selected texture layer, the speed can be adjusted. The cross-fade between both texture is absolutely irregular as the in-and out-fades have random durations.

Parameter	Description	Value Range	Default
Mix	Level of effect itself	0-255	0
Flash Speed	Flash Speed	0-65535	32768

▼ Sync Color Strobe



Flashes a colored layer into the selected texture layer, alpha value, speed and color can be adjusted. There is no cross-fade between both textures.

Parameter	Description	Value Range	Default
Mix	Level of effect itself	0-255	0
Red	Color picker / Level of red	0-255	255
Green	Color picker / Level of green	0-255	255
Blue	Color picker / Level of blue	0-255	255
Alpha	Level of transparency	0-255	255
Flash Speed	Flash Speed	32768-65535	32768

### 5.4.2.11.44 STYLIZE

#### ▼ ASCII Replace



Replaces the texture of the layer with ASCII symbols, size and color intensity of the symbols can be adjusted, as well as the type of symbols.

Parameter	Description	Value Range	Default
Mix	Level of effect itself	0-255	0
Tiling	Tiling	0-65535	8192
Col	Col	0-65535	0
ASCII Map	ASCII Map	-	-

#### ▼ Film Look



Renders the layer texture in an old-fashioned film look, different values like sepia, grain and noise can be adjusted separately.

Parameter	Description	Value Range	Default
Mix	Level of effect itself	0-255	0
Sepia	Sepia	0-255	225
Noise	Noise	0-255	220
Noise Size	Noise Size	0-255	12
Grain	Grain	0-255	93

Flicker	Flicker	0-255	220
Mask	Mask	0-255	72
Scroll	Scroll	0-65535	7900

▼ Wireframe Edges

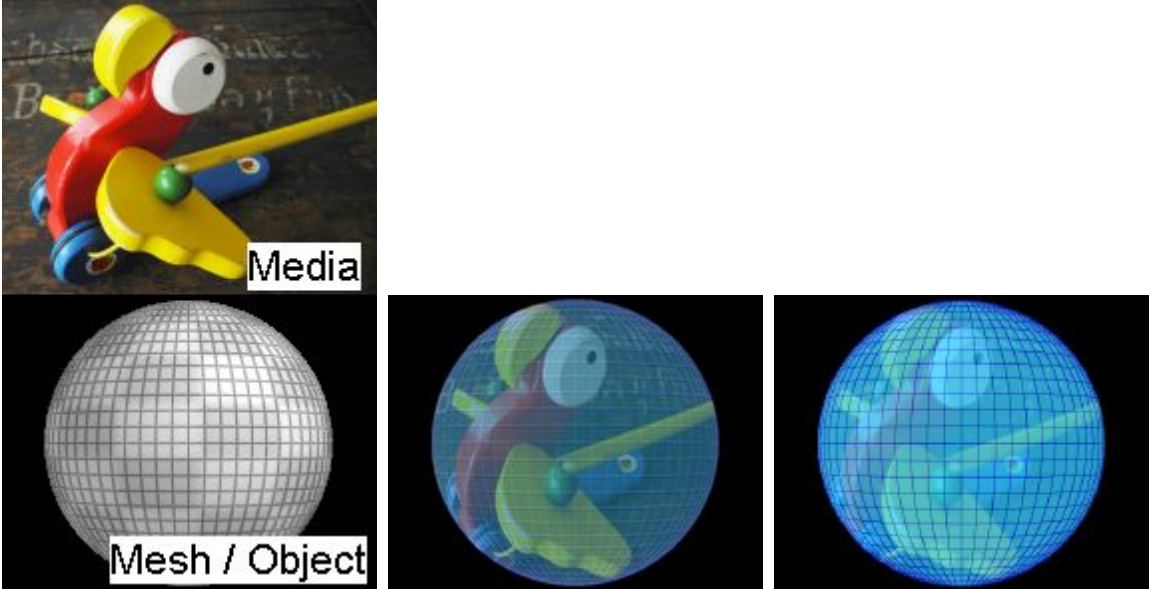

This effect works only with an assigned 3D object. It overlays the layer texture with two adjustable colors. First, the edge wireframes of the object are made visible with a color and alpha level of your choice. Second, a fill color and transparency can be assigned. The width of the wireframes can be adjusted.

Parameter	Description	Value Range	Default
Mix	Level of effect itself	0-255	0
Red Edge	Red Edge	0-255	255
Green Edge	Green Edge	0-255	255
Blue Edge	Blue Edge	0-255	255
Alpha Edge	Alpha Edge	0-255	255
Red Fill	Red Fill	0-255	0
Green Fill	Green Fill	0-255	0
Blue Fill	Blue Fill	0-255	0
Alpha Fill	Alpha Fill	0-255	255
Width	Width	0-65535	13500

▼ Wireframe

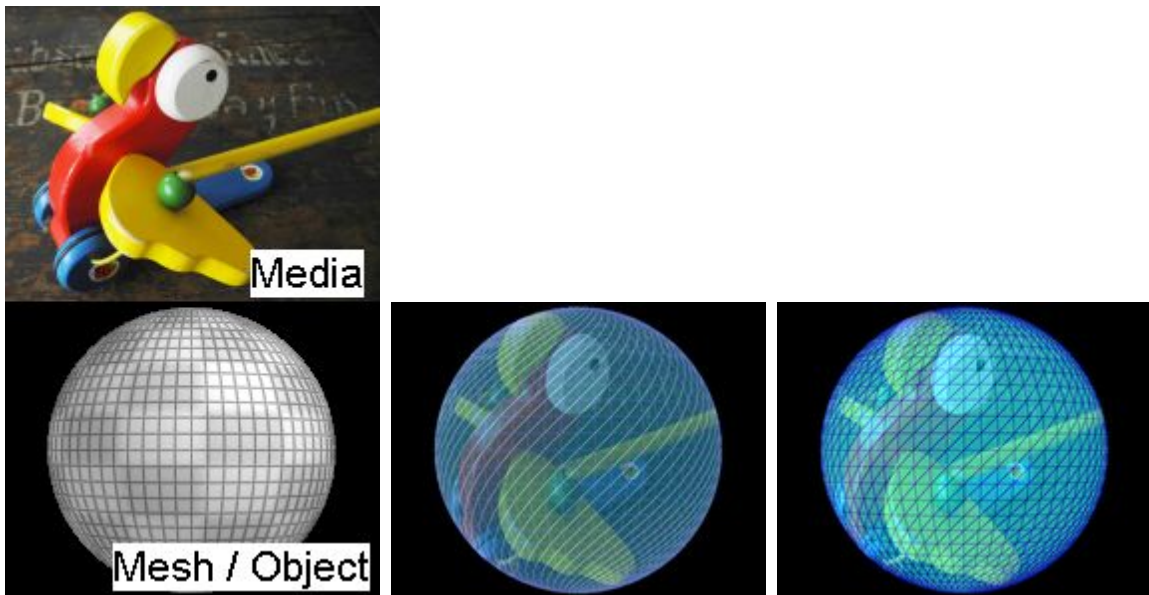

This effect works only with an assigned 3D object. It overlays the layer texture with two adjustable colors. First, the polygon wireframes of the object are made visible with a color and alpha level of your choice. Second, a fill color and transparency can be assigned. The width of the wireframes can be adjusted.

Parameter	Description	Value Range	Default
Mix	Level of effect itself	0-255	0
Red Edge	Red Edge	0-255	255
Green Edge	Green Edge	0-255	255
Blue Edge	Blue Edge	0-255	255
Alpha Edge	Alpha Edge	0-255	255
Red Fill	Red Fill	0-255	0
Green Fill	Green Fill	0-255	0
Blue Fill	Blue Fill	0-255	0
Alpha Fill	Alpha Fill	0-255	255
Width	Width	0-65535	13500

### 5.4.2.11.45 TRANSITION

#### ▼ Alpha 16bit

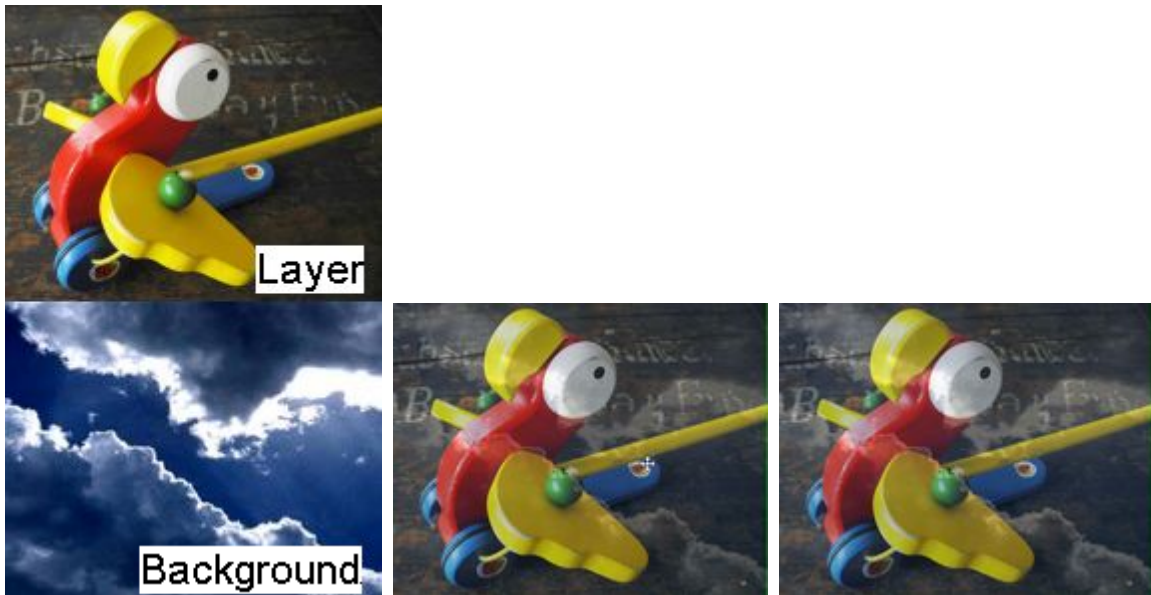

Fades the opacity of the texture layer in 16-bit increments by multiplying the alpha value with a factor. This means that the color values are preserved. Mix 1 = completely transparent, 65535 = completely visible.

Parameter	Description	Value Range	Default
Mix	Level of effect itself	0-65535	0

#### ▼ Dissolve 16bit

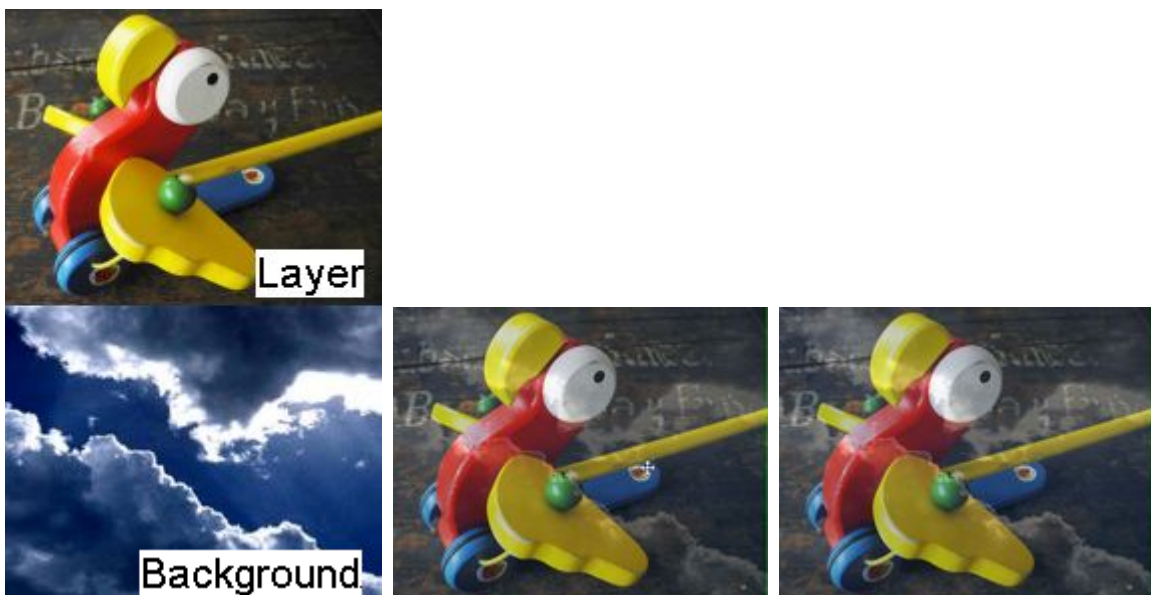

Dissolves the texture layer in 16-bit increments by multiplying the alpha as well as the RGB values with a factor. Mix 1 = completely transparent, 65535 = completely visible.

Parameter	Description	Value Range	Default
-----------	-------------	-------------	---------

Mix      Level of effect itself      0-65535      0

▼ **Transition Crop Media Mask**

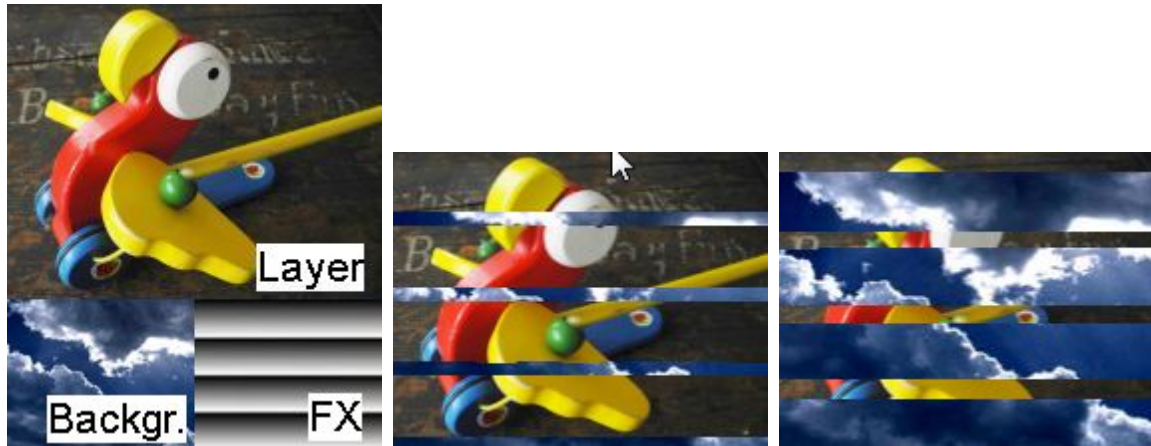

Per default, when a layer fades out (i.e. the opacity value decreases from 255 to 0) the opacity value for each individual pixel is the same. With the TransitionFX you can set up a so-called "Opacity Map". Apply one of your own images to the effect. The layer now fades according to the chosen map, but in contrary to other Transition FX it (dis-) appears in steps, not gradually. Dark areas in the map fade out first, white ones at last. The contrary applies for a fade in.

The TransitionFX depends only on the "XFade" parameter, not on the "Opacity" of the layer!

Parameter	Description	Value Range	Default
Mix	Level of effect itself	0-255	0
XFade	XFade	0-255	0
Media	Media file as source for overlay or mask	-	-

▼ **Transition Media Mask**

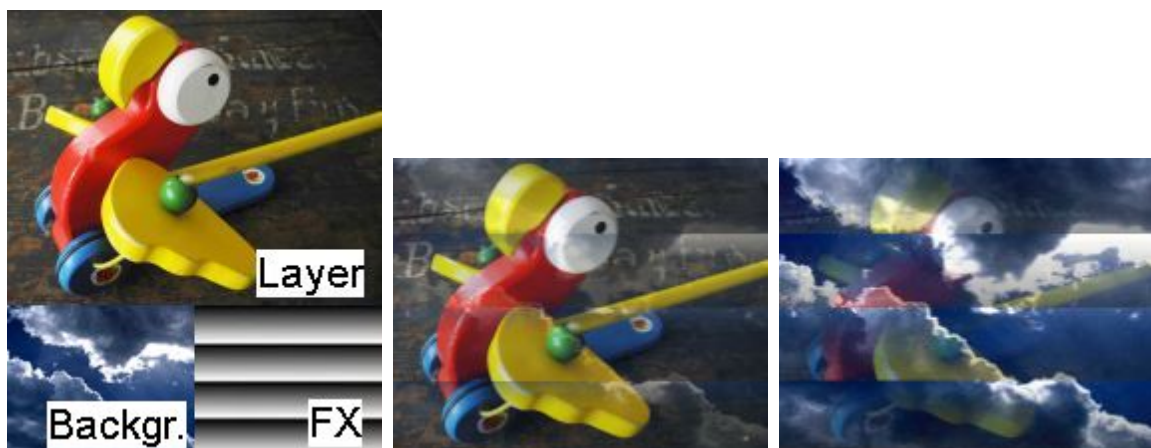

Per default, when a layer fades out (i.e. the opacity value decreases from 255 to 0) the opacity value for each individual pixel is the same. With the TransitionFX you can set up a so-called "Opacity Map". Apply one of your own images to the effect.

The layer now fades according to the chosen map. Dark areas in the map fade out first, white ones at last. The contrary applies for a fade in.

The TransitionFX depends on the "Opacity" of the layer!

Parameter	Description	Value Range	Default
Mix	Level of Effect	0-255	0
Media	Media to be used for transition		

▼ **TransitionFX**

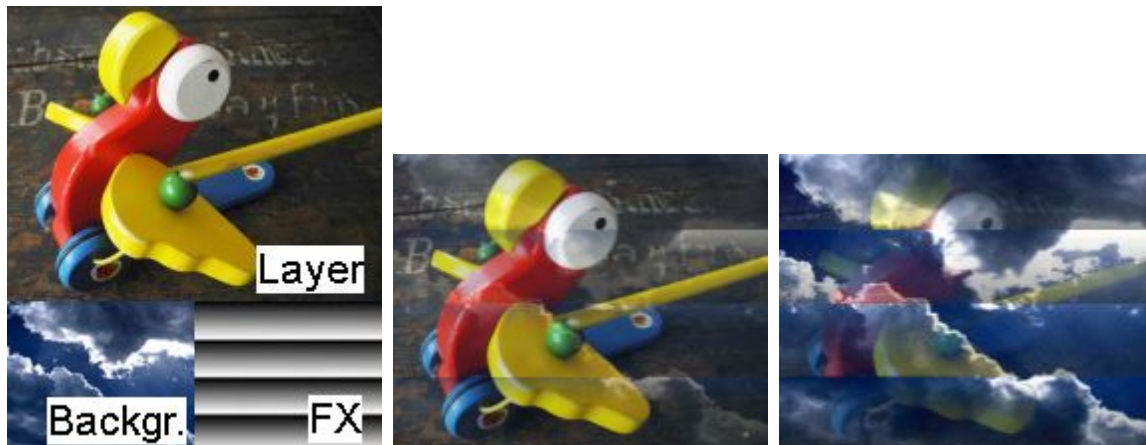

Per default, when a layer fades out (i.e. the opacity value decreases from 255 to 0) the opacity value for each individual pixel is the same. With the TransitionFX you can set up a so-called "Opacity Map". Choose one of the hundreds Pandoras Box' predefined wipes and transitions.

The layer now fades according to the chosen map. Dark areas in the map fade out first, white ones at last. The contrary applies for a fade in.

The TransitionFX depends on the "Opacity" of the layer!

Parameter	Description	Value Range	Default
Mix	Level of Effect	0-255	0
Opacity Map	Choose one of the Transition FX		

All available TransitionFX are listed below:



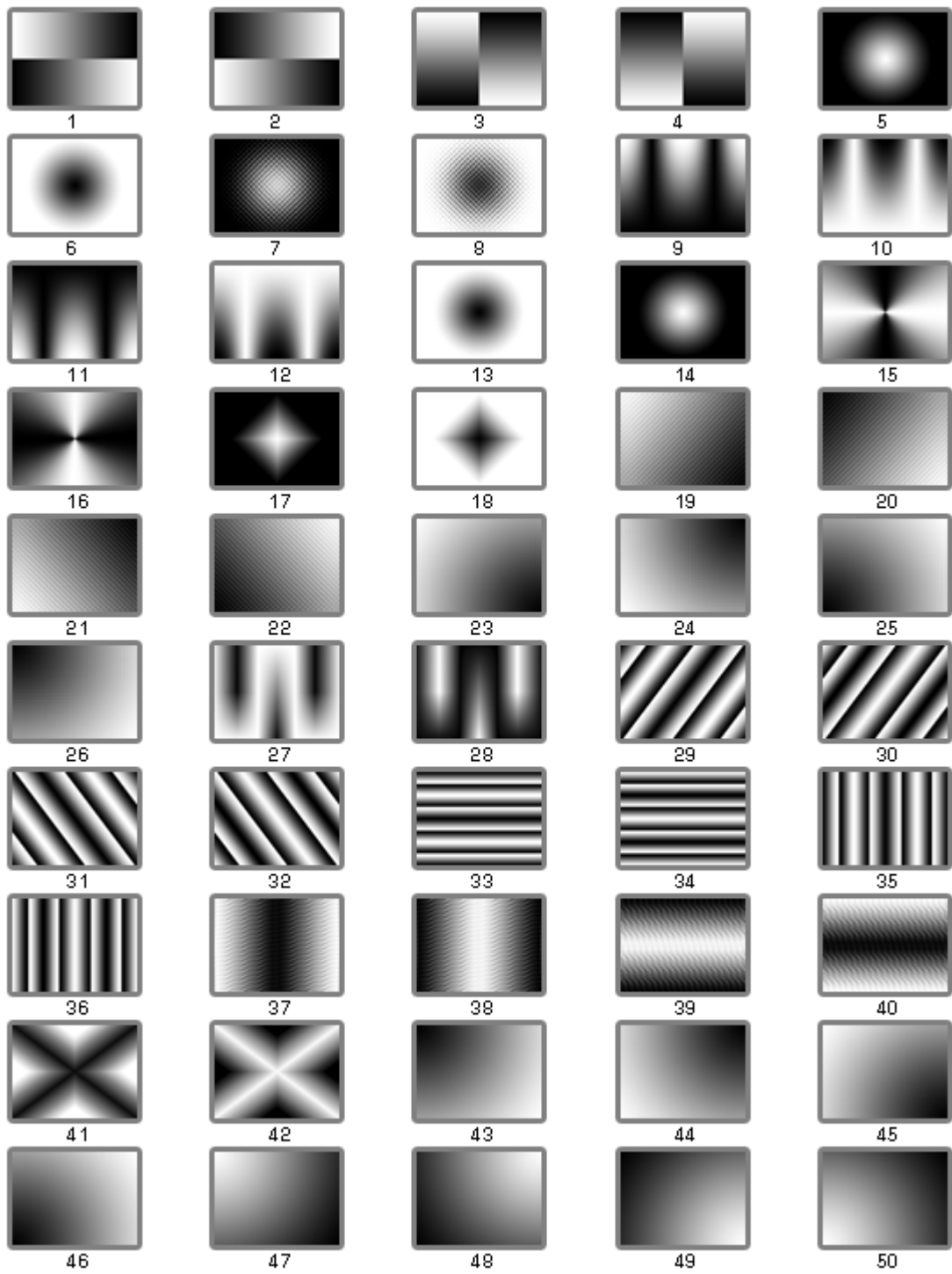

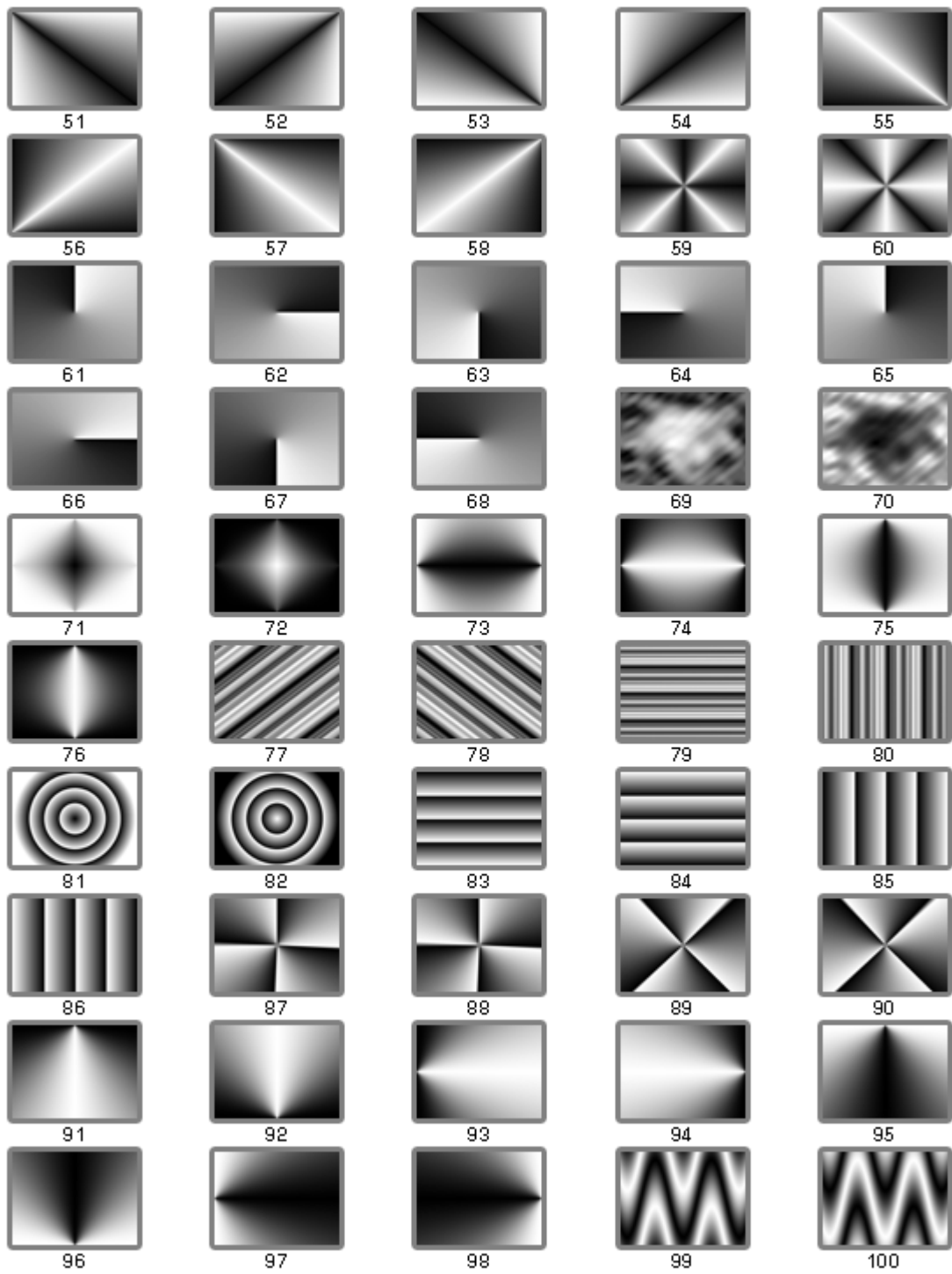

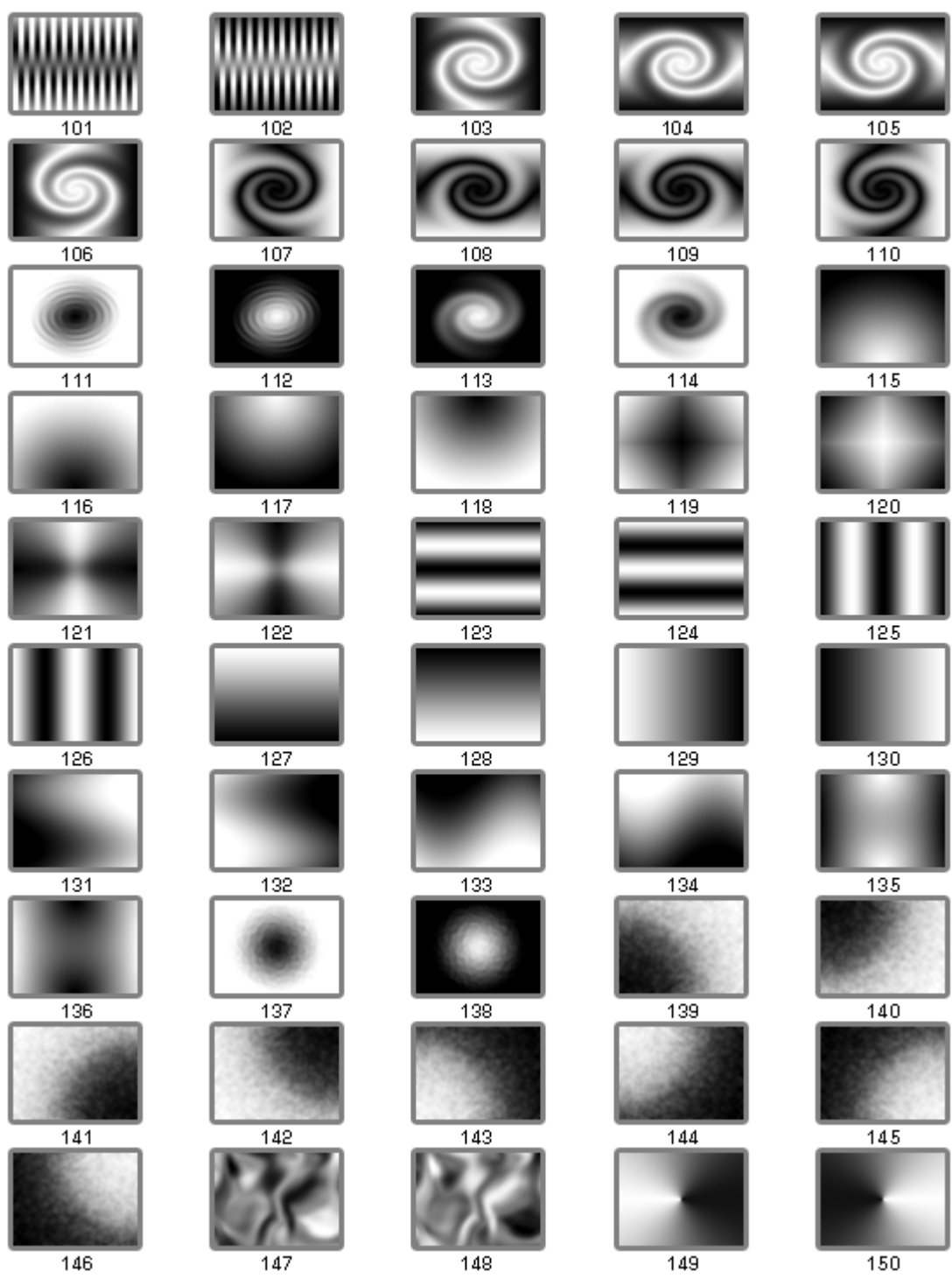

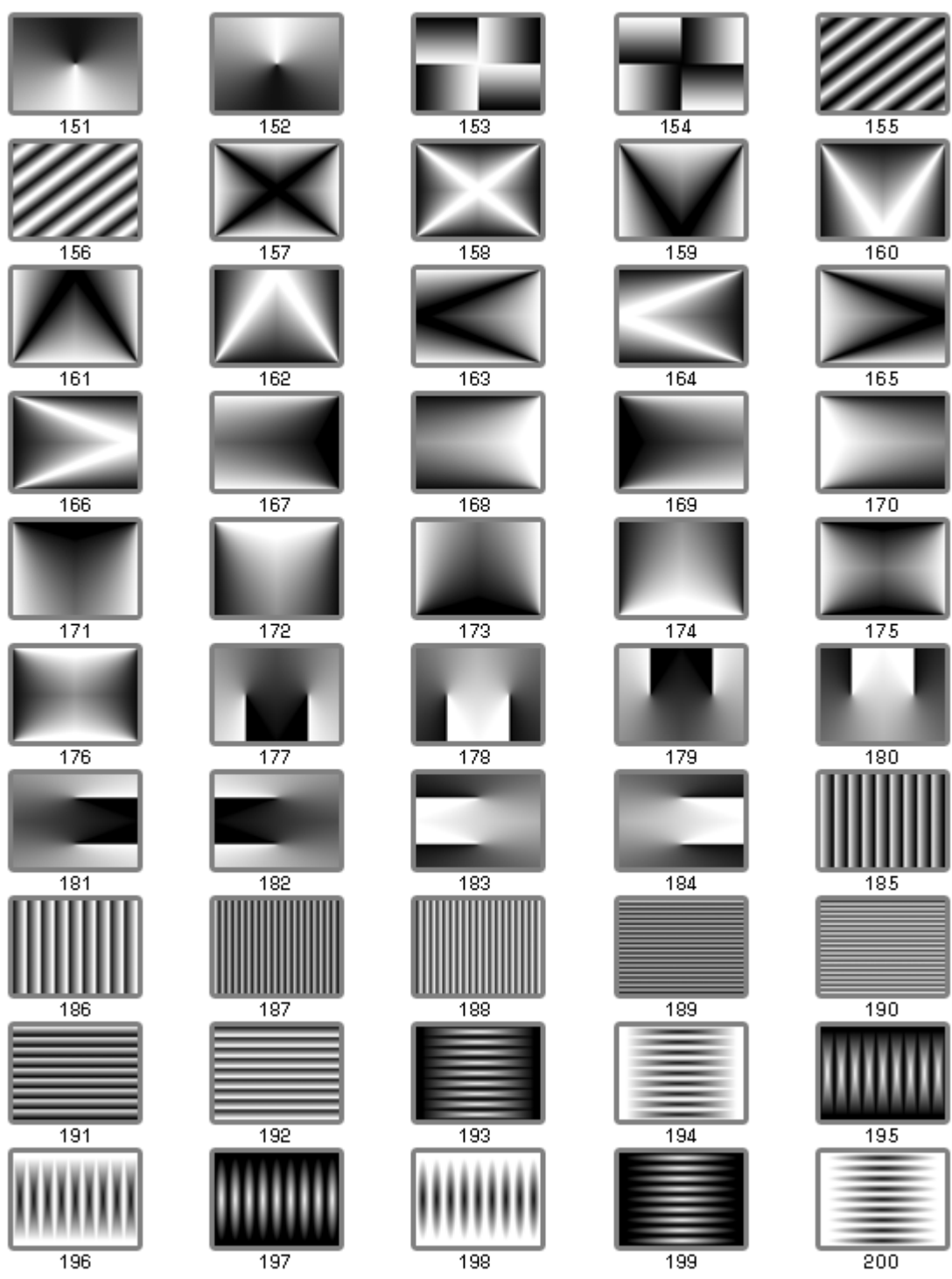

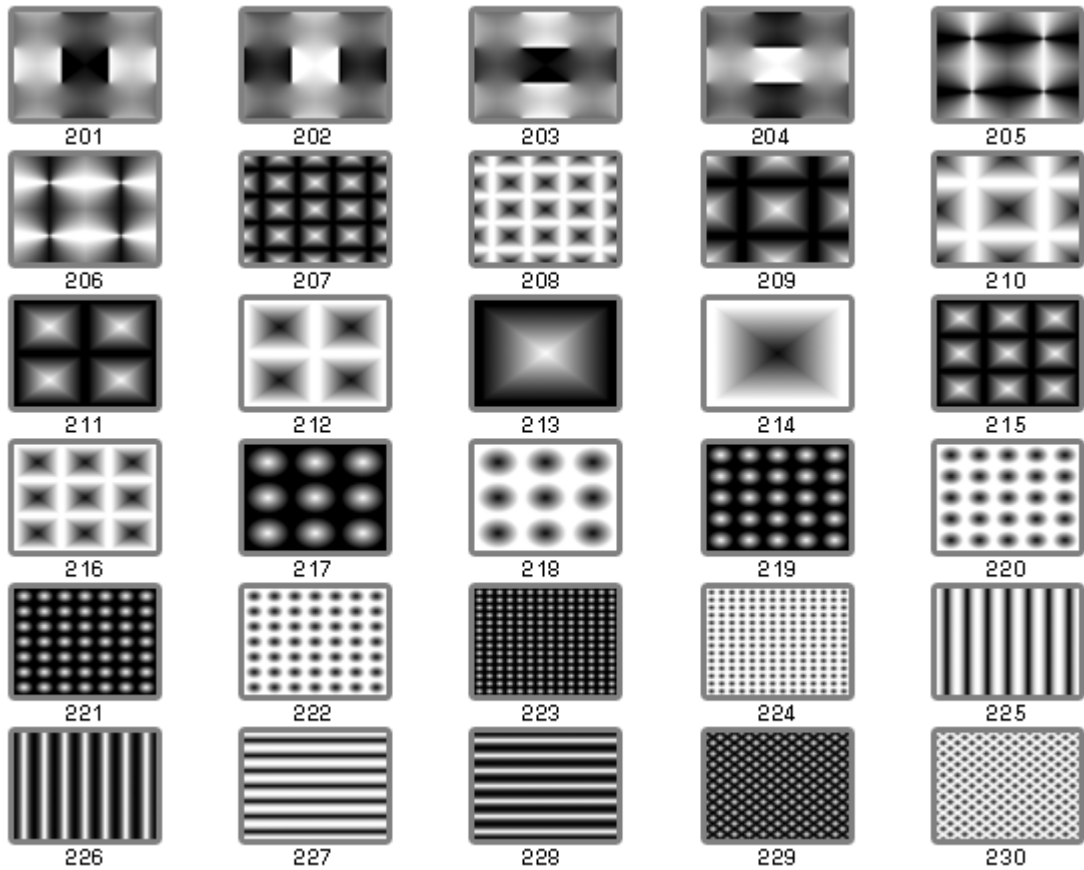

### 5.4.2.11.46 UV MAPPING

#### ▼ AutoAspect Scroll Horizontal (infinite)



Scrolls the media from right to left or left to right by repeating it endlessly. The scrolling speed and horizontal aspect ratio can be adjusted. If the "Width" parameter is set to the texture's width, no scaling occurs.

Parameter	Description	Value Range	Default
Mix	Level of effect itself	0-255	0
Speed X	Horizontal speed	0-65535	32768
Width (px)	Width (px)	0-65535	1024

▼ **AutoAspect Scroll Horizontal (steady speed)**

Please use the effect ["AutoAspect Scroll Horizontal \(infinite\)"](#)<sup>565</sup> instead. The different calculation of the scrolling allows infinite usage.

Parameter	Description	Value Range	Default
Mix	Level of effect itself	0-255	0
Speed X	Horizontal speed	0-65535	32768
Width (px)	Width (px)	0-65535	1024

▼ **Dual Head Split H**



Splits the layer texture horizontally into two areas. The layer texture is repeated, whilst "Factor" defines the offset. The separation can be softened manually.

This effect allows splitting the Pandoras Box output when for example using (Matrox) Dual Head Devices. Assign it to the output itself or to a layer that is toggled into the [Output Rendering Pass](#)<sup>297</sup> by using the [Layer Inspector](#)<sup>208</sup>.

Parameter	Description	Value Range	Default
Mix	Level of effect itself	0-255	0
Factor	Factor	0-65535	0
Softedge	Softedge	0-65535	0
Curve R	Curve R	0-65535	8000
Curve L	Curve L	0-65535	8000
Center	Center	0-65535	27000

▼ **Dual Head Split V**



Splits the layer texture vertically into two areas. The layer texture is repeated, whilst "Factor" defines the offset. The separation can be softened manually.

This effect allows splitting the Pandoras Box output when for example using (Matrox) Dual Head Devices. Assign it to the output itself or to a layer that is toggled into the [Output Rendering Pass](#)<sup>297</sup> by using the [Layer Inspector](#)<sup>208</sup>.

Parameter	Description	Value Range	Default
Mix	Level of effect itself	0-255	0
Factor	Factor	0-65535	0
Softedge	Softedge	0-65535	0
Curve Top	Curve Top	0-65535	8000
Curve Bottom	Curve Bottom	0-65535	8000
Center	Center	0-65535	27000

▼ **Tripple Head Split H**

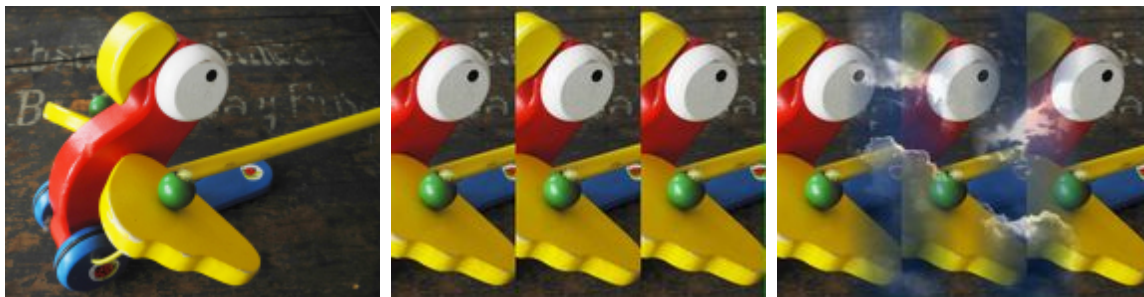

Splits the layer texture horizontally into three areas. The layer texture is repeated, whilst "Factor" defines the offset. The separation can be softedged manually.

This effect allows splitting the Pandoras Box output when for example using (Matrox) Tripple Head Devices. Assign it to the output itself or to a layer that is toggled into the [Output Rendering Pass](#)<sup>297</sup> by using the [Layer Inspector](#)<sup>208</sup>.

Parameter	Description	Value Range	Default
Mix	Level of effect itself	0-255	0
Left	Left	0-65535	0
Right	Right	0-65535	0
Softedge L	Softedge L	0-65535	0
SE L R	SE L R	0-65535	32768
SE L L	SE L L	0-65535	32768
Center1	Center1	0-65535	32768
Softedge R	Softedge R	0-65535	0
SE R R	SE R R	0-65535	32768
SE R L	SE R L	0-65535	32768
Center2	Center2	0-65535	32768

▼ **Tripple Head Split V**



Splits the layer texture vertically into three areas. The layer texture is repeated, whilst "Factor" defines the offset. The separation can be softened manually.

This effect allows splitting the Pandoras Box output when for example using (Matrox) Tripple Head Devices. Assign it to the output itself or to a layer that is toggled into the [Output Rendering Pass](#)<sup>297</sup> by using the [Layer Inspector](#)<sup>208</sup>.

Parameter	Description	Value Range	Default
Mix	Level of effect itself	0-255	0
Top	Top	0-65535	0
Bottom	Bottom	0-65535	0
Softedge T	Softedge T	0-65535	0
SE T T	SE T T	0-65535	32768
SE T B	SE T B	0-65535	32768
Center1	Center1	0-65535	32768
Softedge B	Softedge B	0-65535	0
SE B T	SE B T	0-65535	32768
SE B B	SE B B	0-65535	32768
Center2	Center2	0-65535	32768

▼ **Resize**



Resizes and repositions the image by adjusting the UV map, i.e. without affecting the layer's scale and position values.

Allows resize factors between 0 and 1, and setting an xy offset. The texture is not repeated.

To calculate the precise size parameter: size factor\*65535, e.g for a scale of 0.25: (1/4)\*65535 = 16384

Parameter	Description	Value Range	Default
Mix	Level of Effect	0-255	0



FactorX	Size in X (100% - 0%)	0-65535	65535
FactorY	Size in Y (100% - 0%)	0-65535	65535
Pos U	Horizontal Position	0-65535	32768
Pos V	Vertical Position	0-65535	32768

▼ **Rotate Tiled**



Allows rotating the UV map of the layer texture without affecting the layer's rotation values. The texture is repeated.

Parameter	Description	Value Range	Default
Mix	Level of effect itself	0-255	0
Rot	Rotation angle	0-65535	0

▼ **Rotate**



Allows rotating the UV Mapping of the layer texture without affecting the layer's rotation values. The texture is not repeated.

Parameter	Description	Value Range	Default
Mix	Level of Effect	0-255	0
Rot	Rotation of UV Mapping	0-65535	32768

▼ Texture Zoom



Resizes and repositions the image by adjusting the UV map, i.e. without affecting the layer's scale and position values.

Allows resize factors between 1 and unlimited, and setting an xy offset. The texture is not repeated.

To calculate the precise size parameter:  $(1-1/2*\text{size factor}) * 65535$ ,  
 e.g for a scale of 4:  $(1-1/(2*4)) * 65535 = 7/8 * 65535 = 57343$

Parameter	Description	Value Range	Default
Mix	Level of effect itself	0-255	0
Factor X	Horizontal scale factor (100% -...)	0-65535	0
Factor Y	Vertical factor (100% -...)	0-65535	0
Pos U	Horizontal position	0-65535	32768
Pos V	Vertical position	0-65535	32768

▼ Tiling



Allows tiling the UV Mapping of the layer texture.

Parameter	Description	Value Range	Default
Mix	Level of Effect	0-255	0
Factor	Amount of tiling	0-65535	0
Examples:			
	0 ~ 1x texture width		
	1024 ~ 1.5 x texture width		
	2048 ~ 2x texture width		
	4094 ~ 3x texture width		
	6144 ~ 4x texture width		
	8192 ~ 5x texture width		
	...		

▼ Underscan



Enlarges the content of the layer texture slightly.

Parameter	Description	Value Range	Default
Mix	Level of effect itself	0-255	0

▼ UV Offset



Resizes and repositions the image by adjusting the UV map, i.e. without affecting the layer's scale and position values.

Allows resize factors between 0 and unlimited, and setting an xy offset. The texture is repeated.

To calculate the precise size parameter:  $(1-1/2 \cdot \text{size factor}) \cdot 65535$ ,  
 e.g for a scale of 4:  $(1-1/(2 \cdot 4)) \cdot 65535 = 7/8 \cdot 65535 = 57343$

Parameter	Description	Value Range	Default
Mix	Level of Effect	0-255	0
Offset X	Horizontal offset	0-65535	32768
Offset Y	Vertical offset	0-65535	32768
Factor X	Horizontal scale factor (0% -...)	0-65535	32768
Factor Y	Vertical scale factor (0% -...)	0-65535	32768

▼ UV Remap 4x

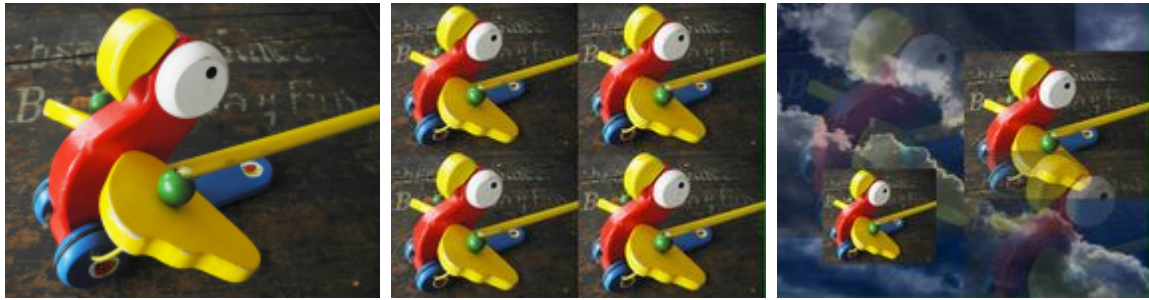

Replicates the layer texture four times and adjusts the UV map. Allows resizing and xy offsetting by mapping four individual, customizable source textures onto a target space. The source texture can not be repeated. The color and alpha level of the target background can be adjusted. All four quadrants of the target can be edited separately similar to the "UV Remap" effect.

Parameter	Description	Value Range	Default
Mix	Level of effect itself	0-255	0
T1 Opacity	T1 Opacity	0-255	255
T1 X	Horizontal t1	0-65535	0
T1 Y	Vertical t1	0-65535	0
T1 Width	T1 Width	0-65535	32768
T1 Height	T1 Height	0-65535	32768
S1 X	Horizontal s1	0-65535	32768
S1 Y	Vertical s1	0-65535	32768
S1 Width	S1 Width	0-65535	65535
S1 Height	S1 Height	0-65535	65535
T2 Opacity	T2 Opacity	0-255	255
T2 X	Horizontal t2	0-65535	32768
T2 Y	Vertical t2	0-65535	0
T2 Width	T2 Width	0-65535	32768
T2 Height	T2 Height	0-65535	32768
S2 X	Horizontal s2	0-65535	32768
S2 Y	Vertical s2	0-65535	32768
S2 Width	S2 Width	0-65535	65535
S2 Height	S2 Height	0-65535	65535
T3 Opacity	T3 Opacity	0-255	255
T3 X	Horizontal t3	0-65535	0
T3 Y	Vertical t3	0-65535	32768
T3 Width	T3 Width	0-65535	32768
T3 Height	T3 Height	0-65535	32768
S3 X	Horizontal s3	0-65535	32768
S3 Y	Vertical s3	0-65535	32768
S3 Width	S3 Width	0-65535	65535
S3 Height	S3 Height	0-65535	65535
T4 Opacity	T4 Opacity	0-255	255
T4 X	Horizontal t4	0-65535	32768
T4 Y	Vertical t4	0-65535	32768

T4 Width	T4 Width	0-65535	32768
T4 Height	T4 Height	0-65535	32768
S4 X	Horizontal s4	0-65535	32768
S4 Y	Vertical s4	0-65535	32768
S4 Width	S4 Width	0-65535	65535
S4 Height	S4 Height	0-65535	65535
Red	Color picker / Level of red	0-255	0
Green	Color picker / Level of green	0-255	0
Blue	Color picker / Level of blue	0-255	0
Alpha	Level of transparency	0-255	0

▼ UV Remap



Resizes and repositions the image by adjusting the UV map, i.e. without affecting the layer's scale and position values.

Allows resizing and xy offsetting by mapping a customizable source texture onto a target space. The source texture can not be repeated.

The color and alpha level of the target background can be adjusted.

Parameter	Description	Value Range	Default
Mix	Level of effect itself	0-255	0
Target X	Horizontal target position	0-65535	0
Target Y	Vertical target position	0-65535	0
T Width	Hor. target scaling (0% -100%)	0-65535	32768
T Height	Vertical target scaling (0% -100%)	0-65535	32768
Source X	Horizontal source position	0-65535	32768
Source Y	Vertical source position	0-65535	32768
S Width	Hor. source scaling (100% -...)	0-65535	65535
S Height	Vertical source scaling (100% -...)	0-65535	65535
Red	Color picker / Level of red	0-255	0
Green	Color picker / Level of green	0-255	0
Blue	Color picker / Level of blue	0-255	0
Alpha	Level of transparency	0-255	0

▼ UV Scroll

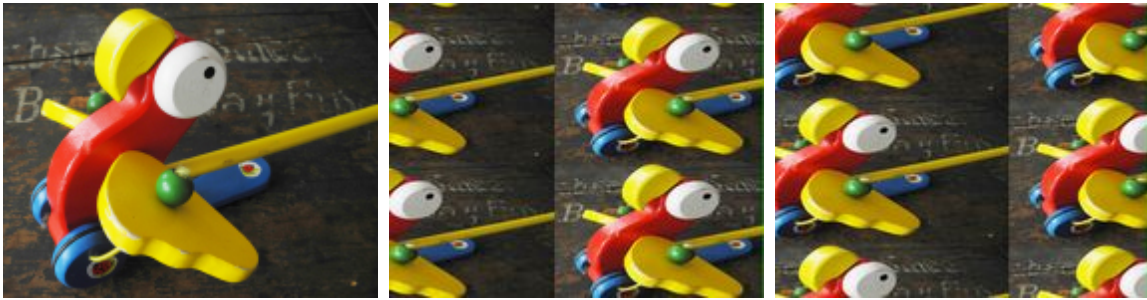

Scrolls the media endlessly in horizontal and / or vertical direction. The scrolling speed in x- and y-direction as well as x- and y-scale can be adjusted.

Parameter	Description	Value Range	Default
Mix	Level of effect itself	0-255	0
Speed X	Horizontal speed	0-65535	32768
Speed Y	Vertical speed	0-65535	32768
Factor X	Horizontal scale factor (100% -...)	0-65535	32768
Factor Y	Vertical scale factor (100% -...)	0-65535	32768

▼ UV Wrap Blend Horizontal



Allows to blend the left edge of a texture with a copy of the content of the right edge. At the same time the right edge blends into the left part. This is of interest when you have a 360° projection and your setup in Pandoras Box is that cameras are spread out and look onto one layer (see image). In case your content shows a hard edge because the right and left pixels do not match you can blend the area with this effect.

For other applications, you may combine this effect with the Resize, UV Offset or Texture Zoom.

Parameter	Description	Value Range	Default
Mix	Level of Effect	0-255	0
Blend	Level of right / left blend	0-65535	32768

▼ UV Wrap Blend Vertical

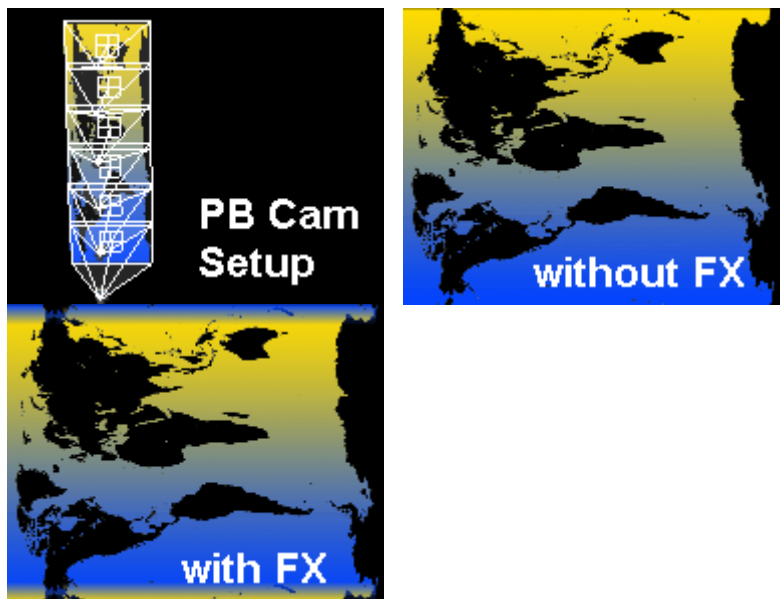

Allows to blend the upper edge of a texture with a copy of the content of the bottom edge. At the same time the bottom edge blends into the upper part. This is of interest when you have a 360° projection with rotated projectors and your setup in Pandoras Box is that cameras are spread out and look onto one layer (see image). In case your content shows a hard edge because the top and bottom pixels do not match you can blend them.

For other applications, you may combine this effect with the Resize, UV Offset or Texture Zoom.

Parameter	Description	Value Range	Default
Mix	Level of Effect	0-255	0
Blend	Level of top / bottom blend	0-65535	32768

### 5.4.2.11.47 WARP

#### ▼ Warp

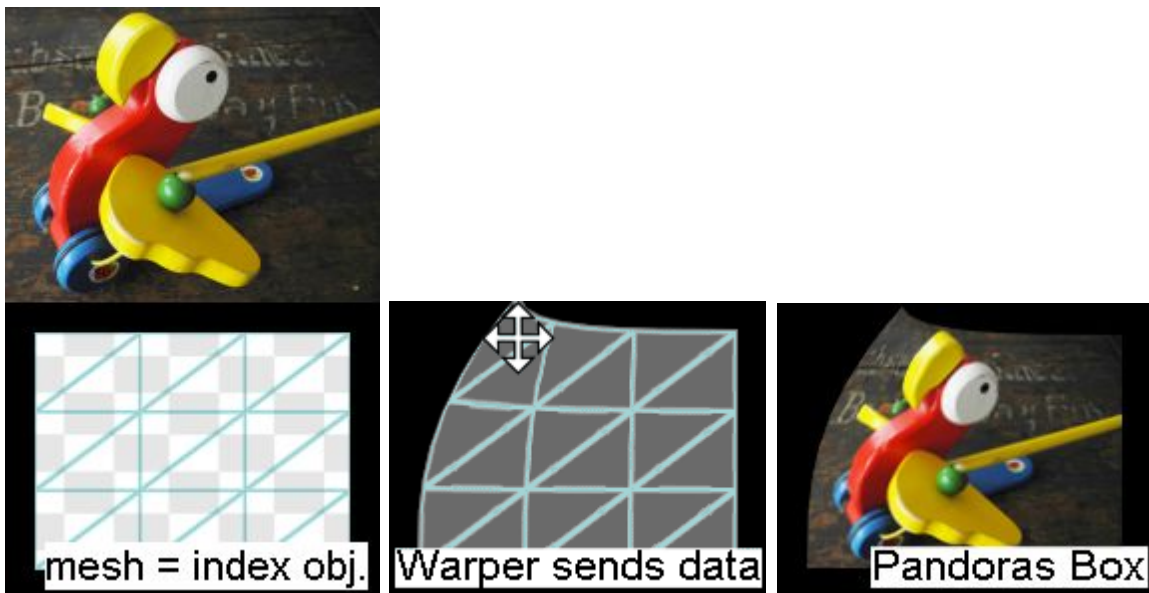

This effect allows deforming an object by moving its vertices live in the [Warper tool](#)<sup>780</sup>. Please refer to the [live warping tutorial](#)<sup>828</sup> in the manual for more information.

Note that this effect has no parameters, you will not see it in the [Device Control tab](#)<sup>164</sup> itself. Only when opening the FX parameter in the [Device Tree](#)<sup>168</sup> you will see the effect. The effect cannot be turned off like other effects, the only way to deactivate it, is to delete it entirely.

Parameter	Description	Value Range	Default
none!		-	-

#### ▼ Warp Target

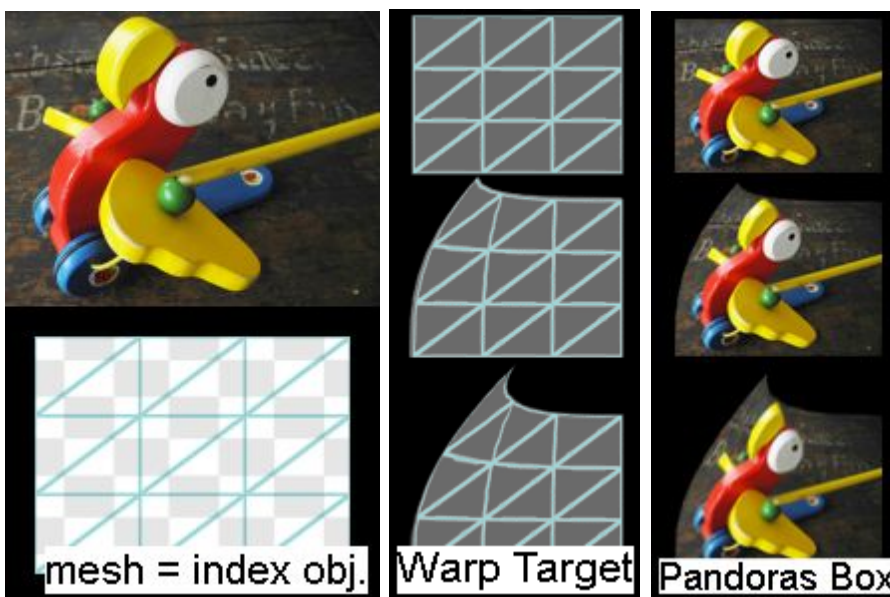



This effect allows deforming an object by moving its vertices according to the saved data in the Warp Target media file. The media file can be either one or several Morph Targets from the Warper tool. Per default that would be a png file, respectively a png image sequence. You may also convert your files to bmp files or a uncompressed video format, e.g. the avi format or a lossless format from the [coolux codec](#)<sup>115</sup>. In any case, activate the "Video Alpha channel" in the [File Inspector](#)<sup>190</sup>! Note that the target media has no separate playback control, use a video file as a layer texture or work with the Share layer feature.

Please refer to the [live warping tutorial](#)<sup>828</sup> in the manual for more information about the steps in the Warper.

Parameter	Description	Value Range	Default
Target	Target	-	-

### 5.4.3 GRAPHIC LAYER CONTROL



Graphic and Video Layers have very similar functions, they only differ in the properties listed below. For information about all other sections of the graphic layer (like position, rotation, scale...) please refer to the explanation of the [Video Layer Control](#)<sup>298</sup>.

#### No Playback Control / No Audio Section

Video and audio files can't be played back on a graphic layer. But you have the possibility of choosing and showing a still frame from a video file.

Use the parameter "Frame" to scroll through the video file. The value range of 0..65535 corresponds the 100% video length.

To show animated files on a graphic layer, use the option ["Share Layer Texture"](#)<sup>300</sup> and route the texture of another layer to this graphic layer.

You may add an unlimited amount of Graphic Layers to your project. Do this by right-clicking on the site to open the [context menu](#)<sup>172</sup> > Add Graphic Layer. The new Graphic Layer will be added below the highest Graphic Layer in the Device Tree. The layer can be moved to another position in the device tree by [drag and drop](#)<sup>170</sup>.

## 5.4.4 AUDIO TRACKS



Dedicated audio tracks are available for Pandora's Box Manager, Player and Server systems. Audio tracks allow playing back ASIO wav files while being synchronized to a master clock. Please note that an ASIO sound card needs to be set up in the Configuration tab, section [ASIO Audio](#) <sup>156</sup>. This chapter also includes more information regarding the ASIO support, e.g. synchronization and channel settings.

Another possibility to playback sound is, to use a video layer but in that case it can not be synchronized.

The Audio Track Control includes the following sections: Information about DMX Control is included, addressing customers who wish to remote control a layer with a lighting desk via DMX or Art-Net. If you like to use the Widget Designer or another application instead, please refer to [this parameter list](#) <sup>1256</sup>.

[Media](#) <sup>578</sup>

[Playback Transport](#) <sup>579</sup>

[Volume](#) <sup>579</sup>

[Inpoint/Outpoint](#) <sup>580</sup>

[Pan](#) <sup>580</sup>

### 5.4.4.1 MEDIA

The Audio Tracks will play mono and stereo PCM Wave files (16 or 24 bit) with the sample rate that is preset in the Audio Configuration only, there will be no sample rate conversions done: each sample will be played back 1:1.

To assign an audio resource to a track, drag and drop the resource from the project tab onto the designated track. You can also highlight the target track by left-clicking on it and use the right-click command on the resource in the project tab "assign to active device" or just double-click on the audio file. Media can also be assigned from the thumbnail browser by double clicking it for attributing it to the selected highlighted layers.

To remove the resource of the track, right-click in the layer tree on the media parameter and choose "reset" or right-click on the media thumbnail in the Device Control Tab.

DMX Control:

For DMX control depending on the ID assignment in the Pandora's Box manager user interface, each

layer can access 255 folder and 255 file IDs of individual media files as well as live inputs, see [DMX Tables](#)<sup>623</sup> > [DMX Table PB Manager](#)<sup>623</sup>.

The media selection channels are 8bit, the default value is set to 0.

Media Folder

0	No folder
1..255	Folder 1..255

Media File

0	No file
1..255	File 1..255

### 5.4.4.2 PLAYBACK TRANSPORT

The Playback Transport channel allows setting the play mode of the audio file to Play Once, Stop, Pause and Play Loop.

DMX Control:

DMX values for Playback Transport, see [DMX Table PB Manager](#)<sup>623</sup>.

The Playback Transport channel is 8bit and the default value is 0.

0	Stop
64 (1-127)	Play Once
128	Pause
192 (129-255)	Play Loop

### 5.4.4.3 VOLUME

With the Volume parameter the Volume of the audio files may be controlled.

DMX Control:

DMX values for Volume Control, see [DMX Table PB Manager](#)<sup>623</sup>.

The Volume channel is 16bit and the default value is 0.

Volume

0	No Audio, -96dB
..	
32768	0dB
46300	3dB
65535	Max. Volume

Please note, that for Widget Designer or other controlling applications, the range of values is 0 - 2, more information can be found in the [parameter list](#)<sup>1256</sup>.

The volume is measured in decibel and is based a logarithmic function. To convert an external WD value to a decibel value in Pandoras Box or vice versa, please use this formula:

$$10^{PB/20} = WD \quad \log_{10}(WD) \cdot 20 = PB$$

$$10^{6.02/20} = 10^{0.3} = 2.0 \quad \log_{10}(2.0) \cdot 20 = 0.3 \cdot 20 = 6.02$$

0	-96 dB
0.2	-13.98) dB

0.4	-7.96 dB
0.6	-4.44 dB
0.8	-1.94 dB
1.0	0 dB
1.2	1.58 dB
1.4	2.92 dB
1.6	4.08 dB
1.8	5.11 dB
2.0	6.02 dB

#### 5.4.4.4 INPOINT / OUTPOINT

Set the in- and outpoint to define a specific start & end marks of an audio clip, the play once and play loop video mode will work in the resized area.

The In- & Outpoint selection works on a percentage base of the overall audio file length.

DMX Control:

DMX values for Inpoint Control, see [DMX Table PB Manager](#)<sup>623</sup>.

The Inpoint channel is 16bit and the default value is 0.

Inpoint

0	File Beginning
1 ... 65534	
65535	End of File

DMX values for Outpoint Control, see [DMX Table PB Manager](#)<sup>623</sup>.

The Outpoint channel is 16bit and the default value is 65535.

Outpoint

0	File Beginning
1 ... 65534	
65535	End of File

#### 5.4.4.5 PAN

The Pan Control allows varying the relative levels of the two channels of a stereo source.

When not having the Pan Parameter modified, both channels of a stereo source will have the same level.

Turning Pan to 0 will output the left channel only, turning Pan to 65535 will output the right channel only.

DMX Control:

DMX values for Pan Control, see [DMX Table PB Manager](#)<sup>623</sup>.

The Pan channel is 16bit and the default value is 32768.

Pan

0	Left Channel only
32768	Center - L+R Channel
65535	Right Channel only

## 5.4.5 POINTER LAYER CONTROL

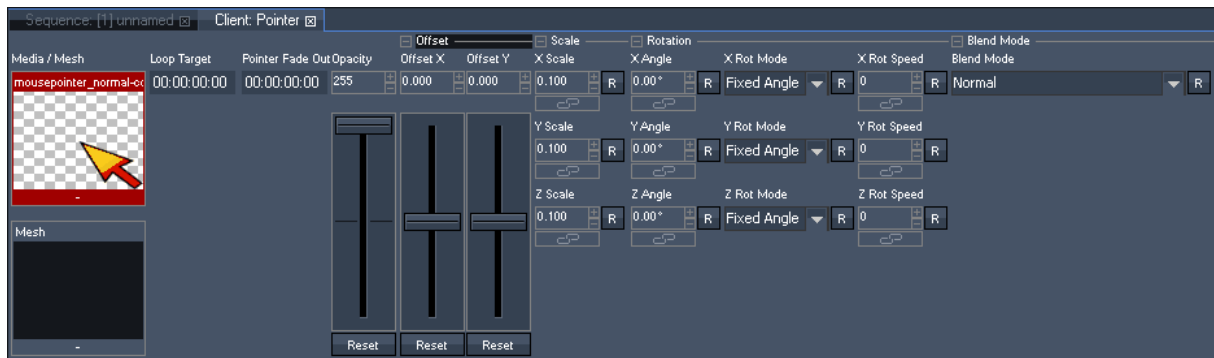

A Pointer Layer displays the local mouse or touch input(s). Per default it is not shown in the Device Tree, please right-click on your master or client system and choose "Add Layers" > "Pointer Layer". As the Pointer Layer has very similar functions to those of a Video Layer, this chapter focuses on the exclusive options. For information about all other sections (like position, rotation, scale...) please refer to the explanation of the [Video Layer Control](#)<sup>298</sup>.

For general information how a Pointer Layer can be used, please see the chapter explaining the feature [Layer Picking](#)<sup>244</sup>. The number of inputs can be set up in the [Pointer Inspector](#)<sup>210</sup>.

### Loop Target and Pointer Fade Out

Both settings are more interesting when using a touch device instead of a device like a mouse. The difference between both devices is that a touch device only sends data when the device is in use, whilst a mouse device is always present.

The Loop Target can be understood as a playback command.

If you are using an always present input, you could use an image sequence or video and set the Loop Target to the starting frame.

If you are working with touch inputs and your media file has a defined fade-in scene and then an looping scene, you can use the Loop Target Time to loop only the images AFTER the fade-in images. An example is depicted below. This means that the Pointer Layer "fades" in as soon as a touch input is received. And as long as the touch input stays present, the pointer loops starting from the Loop Target to the real end of the media file.



The Pointer Fade Out Time is the duration for fading the pointer out if the touch input is not present any more.

Both time can be entered in the format H:MM:SS:FF or shortened to SS:FF or even SFF. So, for example 3 seconds can be 0:00:03:00 or 03:00 or 300

### Offset X and Offset Y

Enter an offset (in generic units) for the X-axis and Y-axis that should be added to the real X and Y position of the input.

## 5.4.6 LIGHT LAYER CONTROL

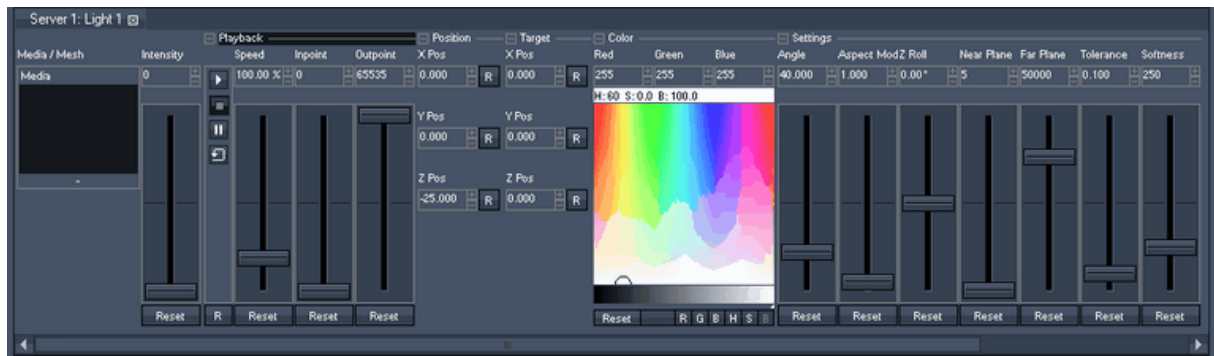

A Light Layer allows setting a light source to illuminate other video and graphic layers. With the help of a particular effect ([Aeon FX tab](#)<sup>136</sup> > [Lighting](#)<sup>484</sup> folder) another layer can "receive" this light and hence be illuminated. Without an lighting effect they will be rendered as always.

- 1a. Create a Light Layer (right-click on Site > Add Device > Add Light Layer)
- 1b. Assign a texture to the light, e.g. a white image from the Stock Assets.
- 2a. Assign a texture to a common video or graphic layer.
- 2b. Drag a Lighting FX from the Aeon FX tab onto this layer. Right-click into the effect's "Media" field, choose "Share Layer Texture" and select the respective light source. Now, the chosen light illuminates the video / graphic layer.

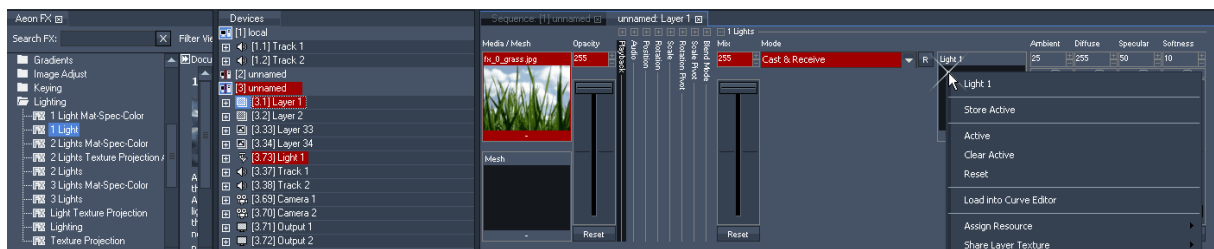

The Light Layer Control includes the following sections:

- [Media Selection](#)<sup>583</sup>
- [Intensity](#)<sup>584</sup>
- [Playback](#)<sup>584</sup>
- [Position](#)<sup>584</sup>
- [Target](#)<sup>585</sup>
- [Color](#)<sup>586</sup>
- [Settings](#)<sup>587</sup>

The following chapters include information about DMX Control, addressing customers who wish to remote control a light layer with a lighting desk via DMX or Art-Net. If you like to use the Widget Designer instead, please refer to [this parameter list](#)<sup>1259</sup>.

The according inspector information is described [here](#)<sup>211</sup>.

Even though it is possible to add as many light layers as you wish, keep in mind that calculating light effects requires a lot of the system's performance. Depending on your settings and of course your hardware, three lights might be already the limit.

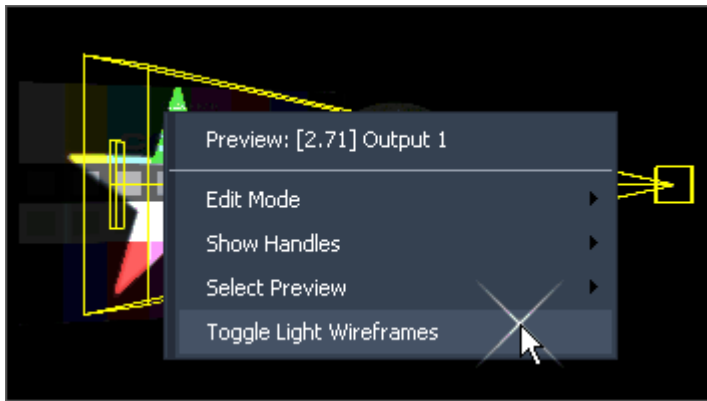

If you wish to see the spanned light cone in your preview window, make a right-click and toggle the light wireframes on. Make sure that under "Show Handles" "Show in Local Node" (or ...Client) is enabled. Please refer to [this chapter](#)<sup>234</sup> if you wish to know more about wireframes and handles.

### 5.4.6.1 MEDIA

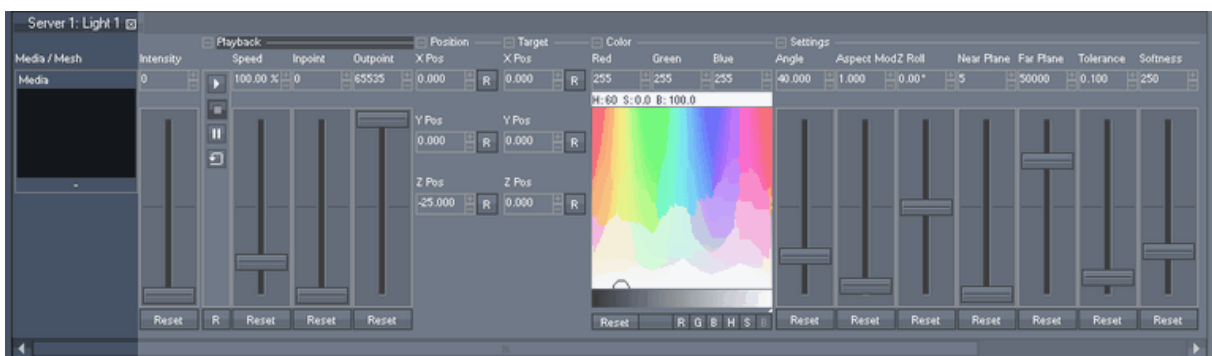

The Media parameter for a light layer is very similar to the one from a normal video layer. Please refer to [this chapter](#)<sup>299</sup> if you want to learn how to assign a media to a layer and what layer sharing means. As well you will find there the DMX Control chart.

At present, it is not possible to use transparency ( $\alpha$  channel) as see-through parts, for this simply use white color.

The media for a light layer acts as a mask or gobo or even as a transparent image in front of a light. In case of choosing a video, it turns the light into a projector.

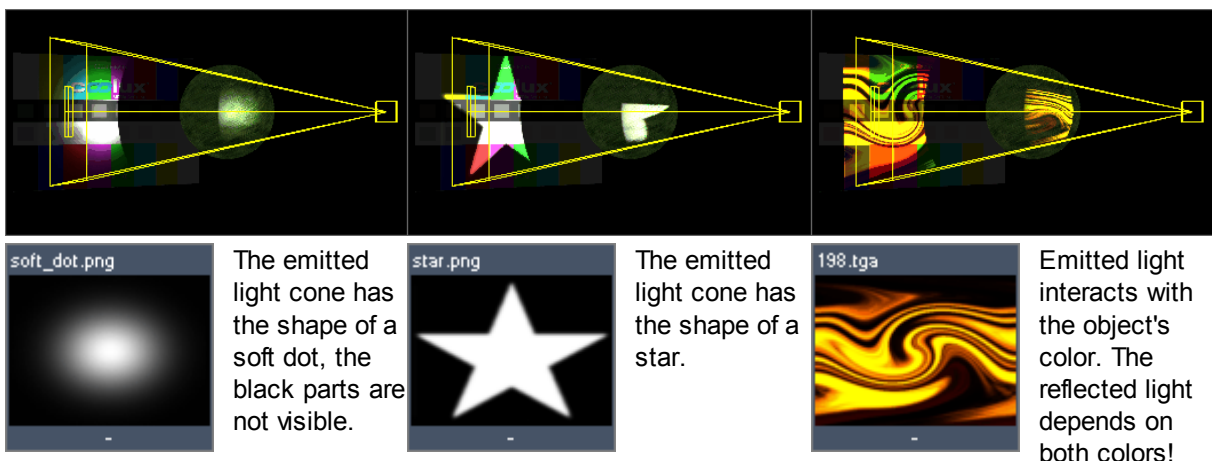

Contrary to a video layer, you can not assign a mesh to a light layer.

### 5.4.6.2 INTENSITY

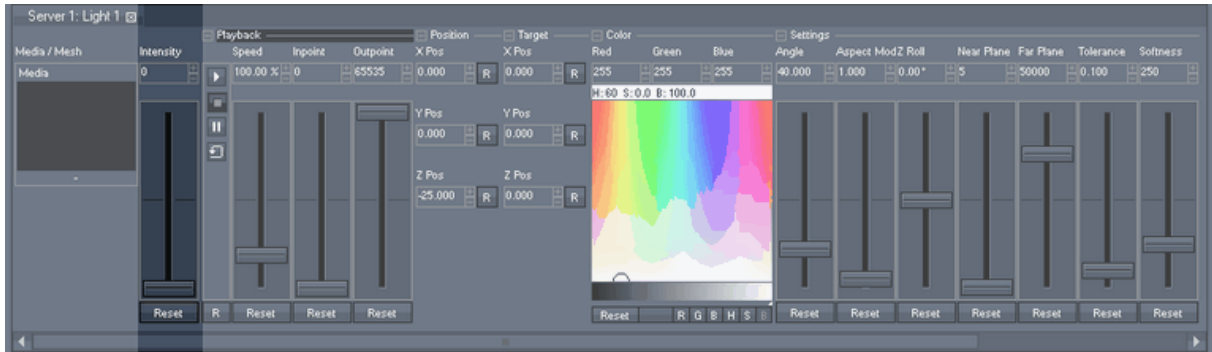

The Intensity parameter sets the intensity of a light source, i.e turning it on and off. Please keep in mind that layers receiving this light as a single light source will not be visible anymore.

Intensity 0% (value 0)            off  
 Intensity 100% (value 255)    on

#### DMX Control

The intensity channel is 8bit, the default value is set to 0.

Intensity

0..255	Fully turned off..Fully turned on
--------	-----------------------------------

### 5.4.6.3 PLAYBACK

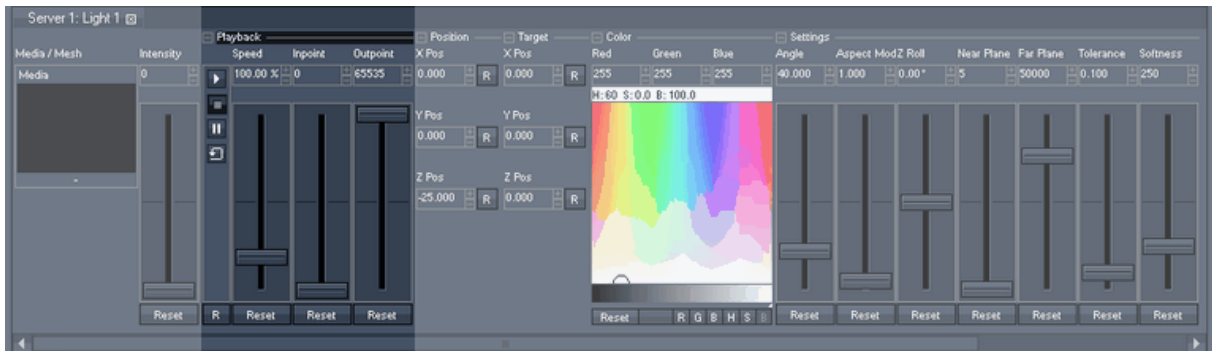

The light layer's Playback parameter section does not differ from a video layer's one. Please refer to [this chapter](#)<sup>302</sup> to learn how to set a video to play, how to run it faster and how to change its first frame. As well you will find there the DMX Control chart.

### 5.4.6.4 POSITION

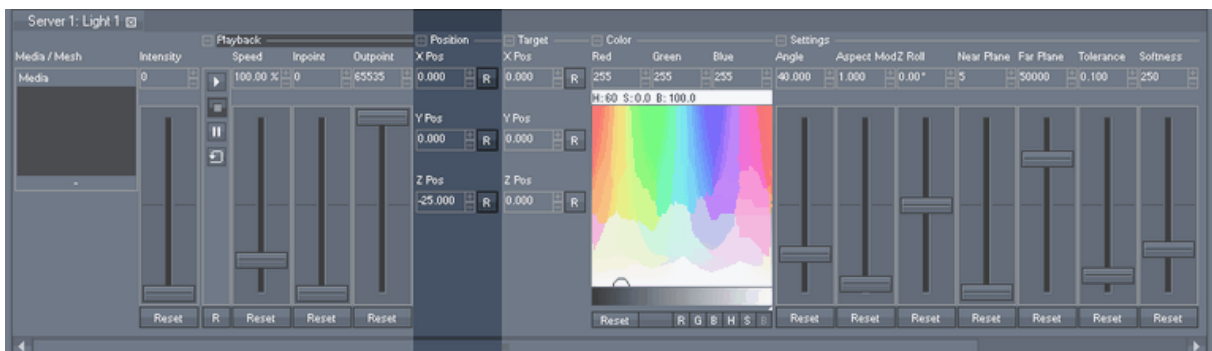



The Position parameters allow changing the position from where the light rays are emitted originally in the 3D space. Just as a camera a light's default position is located at (XYZ = 0,0,-25).

The reason for the units of the position parameter lies in the following: one screen width is always 16 units wide, the height is calculated by the aspect ratio. A 4:3 display is 16 units wide and 12 units high, a 16:9 display is 16 units wide and 9 units high.

Lights in Pandoras Box have no attenuation, which means that their intensity is not a function of the distance from a light source to an object's surface. Thus, the position does only affect the angle of incidence, i.e. how steep the light shines on an object. The second parameter influencing the angle is the [target position](#)<sup>585</sup>. The affect of the angle of incidence is described [here](#)<sup>484</sup> in detail.

**DMX Control**

All position channels are 16bit and the default value is 32768.

Resolution: 1 DMX Step = 0.008 units

X Position:

0	max. position left (-256 units or 16 screen width to the left)
32768	Center
65535	max. position right (+256 units or 16 screen width to the right)

Y Position:

0	max. position bottom (-256 units)
32768	Center
65535	max. position top (+256 units)

Z Position:

0	max. position far (-256 units)
32768	Center
65535	max. position near (+256 units)

**5.4.6.5 TARGET**

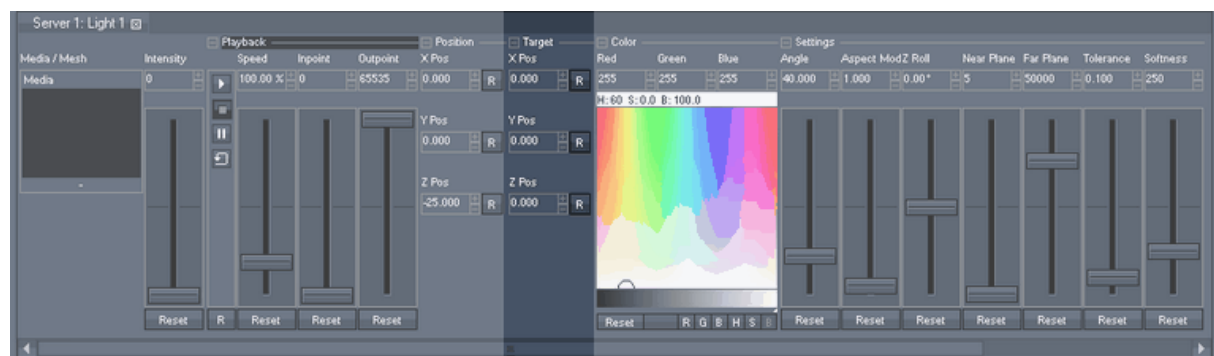

The Target parameters allow changing the position to where the light rays are emitted in the 3D space without moving the light itself. Just as a camera a light's default position is located at X,Y,Z = 0,0,-25.

The reason for the units of the position parameter lies in the following: one screen width is always 16 units wide, the height is calculated by the aspect ratio. A 4:3 display is 16 units wide and 12 units high, a 16:9 display is 16 units wide and 9 units high.

Lights in Pandoras Box have no attenuation, which means that their intensity is not a function of the distance from a light source to an object's surface but is always equally intense. Thus, the target position does only affect the angle of incidence, i.e. how steep the light shines on an object. The second

parameter influencing the angle is the [source position](#)<sup>584</sup>. The affect of the angle of incidence is described [here](#)<sup>484</sup> in detail.

Target X Position:

0	max. position left (-256 units or 16 screen width to the left)
32768	Center
65535	max. position right (+256 units or 16 screen width to the right)

Target Y Position:

0	max. position bottom (-256 units)
32768	Center
65535	max. position top (+256 units)

Target Z Position:

0	max. position far (-256 units)
32768	Center
65535	max. position near (+256 units)

### 5.4.6.6 COLOR

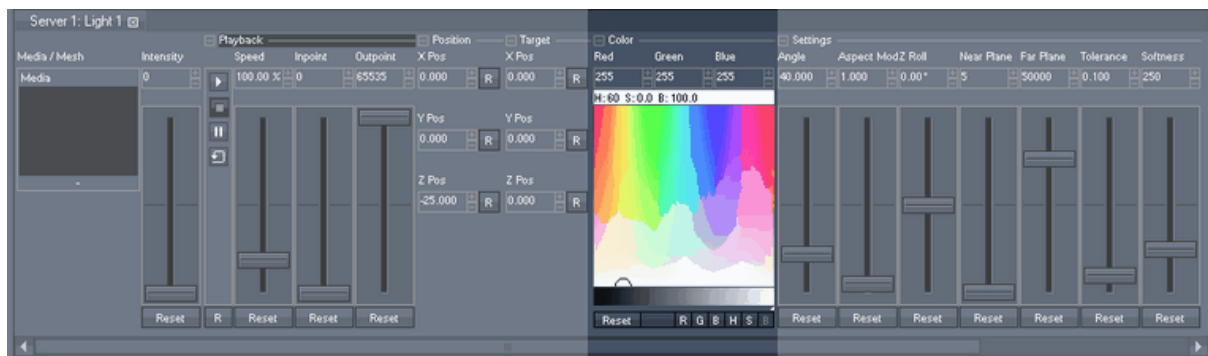

The Color parameter allow changing the color of the emitted light rays. Please refer to [this chapter](#)<sup>323</sup> if you want to learn how to use the color picker.

DMX Control

All Color channels are 8bit, the default value is set to 255.

Red

0...255	Red level, Color Picker
---------	-------------------------

Green

0...255	Green level, Color Picker
---------	---------------------------

Blue

0...255	Blue level, Color Picker
---------	--------------------------

### 5.4.6.7 SETTINGS

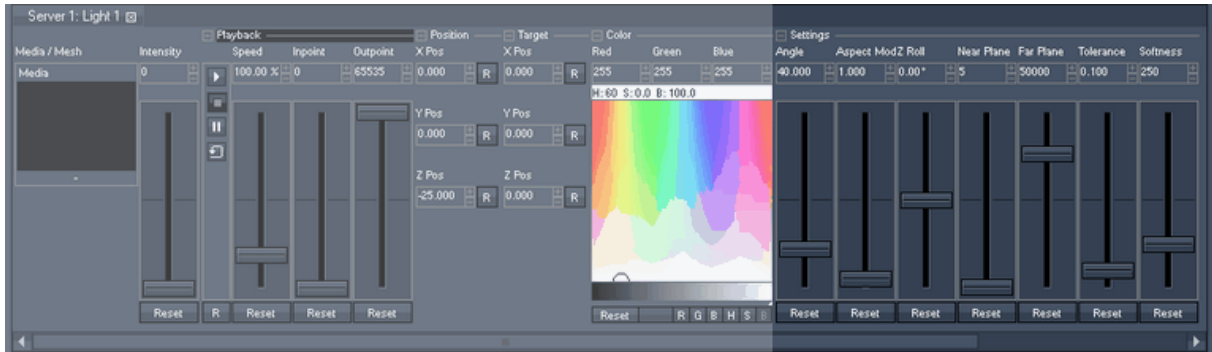

Next to the parameters Position and Target the Settings parameter section allows adjusting the area in your 3D space that will be affected by light. Layers that are not within the spanned light cone cannot be shed with light, cast shadows or be shadowed.

"Angle" resizes the dihedral angle of the light and spans the light cone. By default it is squarish, that is the height equals the width. "Aspect Mode" influences the width-height-ration, whereas "Z Roll" rotates the entire light cone. Contrary to the next mentioned parameters all these parameters can be seen in the preview window if the [Light Wireframes](#)<sup>582</sup> are toggled on.



Figure 1a,b

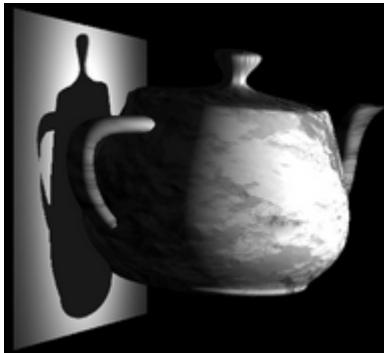
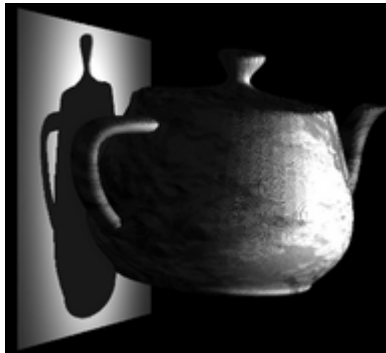

Figure 2a,b

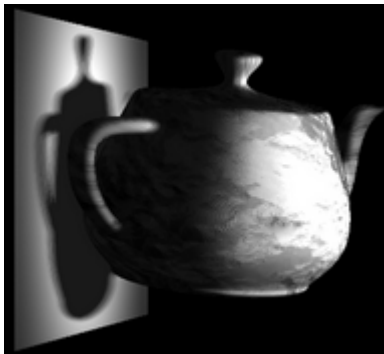

Figure 3a,b

Figure 1a,b) "Near Plane" and "Far Plane" have their origin in the [Camera Control](#)<sup>589</sup>. When looking at the distance from the light source itself, the near plane describes the minimum distance an object is allowed to have in order to cast shadows; the far plane refers to the maximum distance. In the example the near plane starts behind the front part of the jug. Even though it is dipped in light it is not casting shadow any more. Note that the light simply cuts the shadows of the front part of the jug, it is not rendering them any more. It cannot see through the first layers of the object and render the shadow of the back side instead.

Note that the planes are not designed to be an artistic tool. They are rather meant to be used if the depth resolution is too small and objects being too close to each other are rendered in a wrong way. If you have such an issue decrease the distance between both planes without cutting objects.

Figure 2a,b) A higher light "Tolerance" decreases the shadowed area, either on the object itself or another object. If a particular area lies within the light-shadow-border it now tends to be on the illuminated side.

The tolerance level helps to decrease the phenomenon called self-shadowing which can be especially problematic when using objects with a very rough surface.

In the example the tolerance level is set to 0.005 for the left image, and to 0.990 for the right image. Note that 0.990 is so high that even the shadow of the handle is influenced.

Figure 3a,b) A higher shadow "Softness" blurs the shadow border, on the object itself and on another object. It can be especially helpful when working with a [Shadow Map](#)<sup>211</sup> set to a low resolution .

In the example the tolerance level mentioned above is set back to the default value of 0.10.

The softness level is set to 0 for the left image, and to 900 for the right image. Note the difference to the image above. There, the light-shadow-border has moved whereas here, the border remains but the transition is softer.

#### DMX Control

If not listed differently, Settings Channels are 16bit.

#### Angle

Default value is set to 57. Resolution: 1 DMX Step = 0.003 units

0	0.000
14564	40.002
65535	180.000

#### Aspect Mode

Default value is set to 3277.

0	0
3277	1
65535	20

#### Z Roll

Default value is set to 32768.

0	-1080° or 3 rotations clockwise
32768	0°
65535	+1080° or 3 rotations anti-clockwise

#### Near Plane

Default value is set to 5.

0..65535	-256 units
----------	------------

#### Far Plane

Default value is set to 50000.

0..65535	-256 units
----------	------------

Tolerance

Default value is set to 6554.

0	0.000
6554	0.100
65535	1.000

Softness

Default value is set to 16384.

0	0
16384	250
65535	1000

### 5.4.7 CAMERA CONTROL

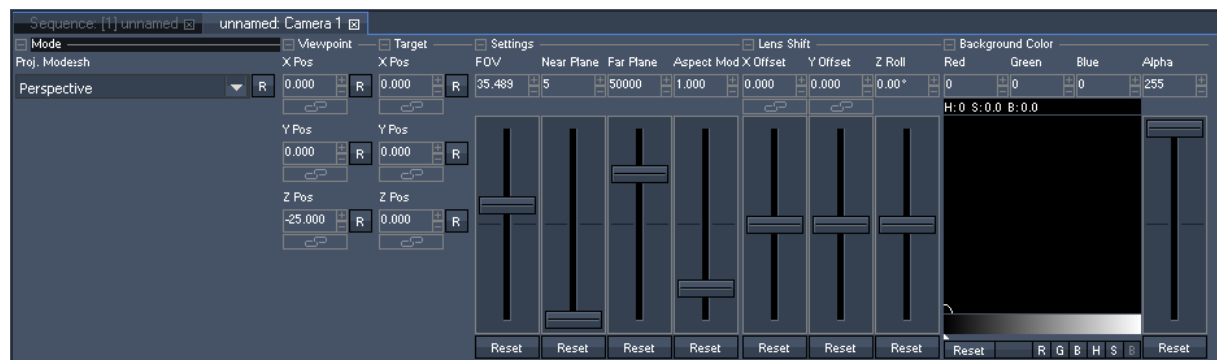

As mentioned in the chapter [V5 Video Processing Pipeline](#)<sup>297</sup> the camera control allows setting up the 3D look-at-point onto your 3D composition. Here you can determine whether each camera should display the same or different areas in 3D space. This allows stretching layers over several outputs or to create softedge blended setups.

Depending on your PB product one, two or four cameras are available whilst a camera on a Server has more parameters than on a Player.

The Camera Control chapter is divided into the following sections. Information about DMX Control is included, addressing customers who wish to remote control a layer with a lighting desk via DMX or Art-Net. If you like to use the Widget Designer or another application instead, please refer to [this parameter list](#)<sup>1257</sup>.

[Projection Mode](#)<sup>590</sup>

[View Point](#)<sup>591</sup> (only available for Servers)

[Target](#)<sup>592</sup> (only available for Servers)

[Settings](#)<sup>594</sup>

[Lens Shift](#)<sup>594</sup>

[Background Color](#)<sup>596</sup> (only available for Servers)

### 5.4.7.1 PROJECTION MODE

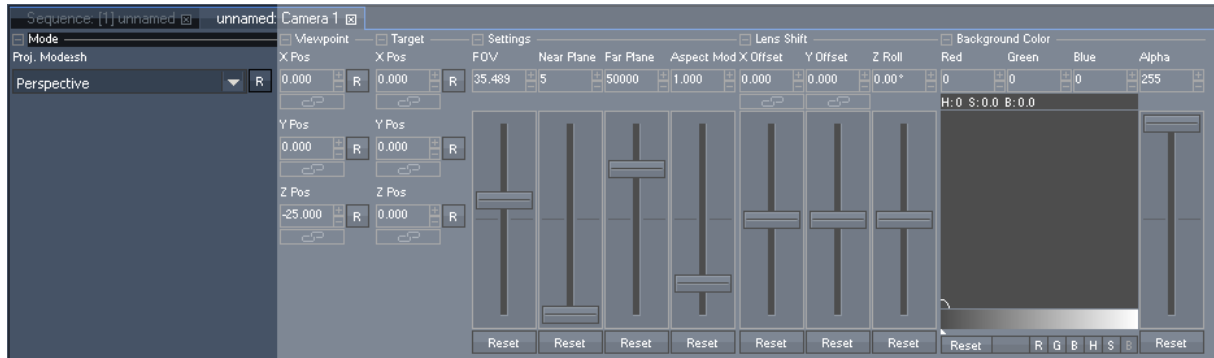

There are two projection modes available for each camera device:

- Perspective Mode (by default) and
- Orthogonal Mode.

The perspective mode allows a perspective angle to your view from different 3D scene.

The orthogonal mode switches off the depth and perspective view of the camera.

The control channels do still access the three dimensional orientation of the 3D camera.

Please note:

The Z position of any layer will only affect the rendering order but won't make any visual change to the layer.

See here an example of how the projection mode affects the output:

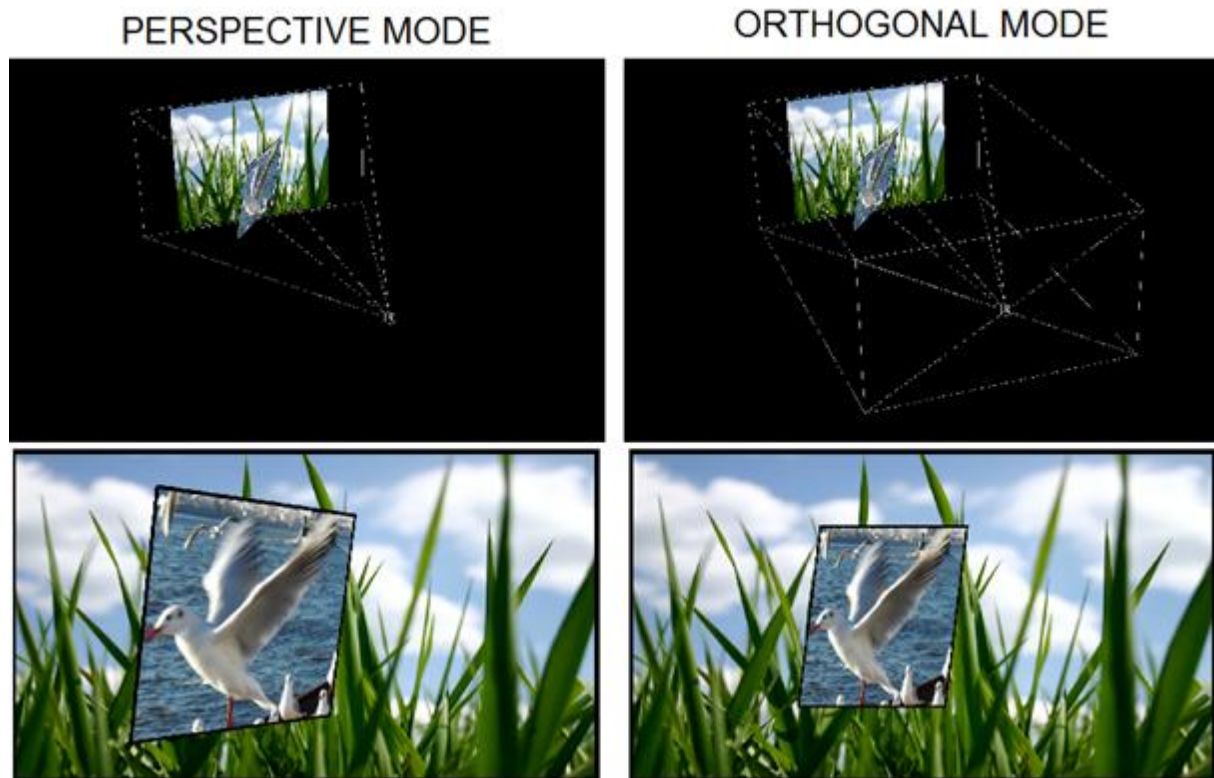

The images at the top show the 3D scene in the global cam preview: in perspective mode (left) and in orthogonal mode (right). The 3D scene stays the same, but the camera wireframes change according to the projection mode. The images at the bottom show the resulting output: in perspective mode (left) and in orthogonal mode (right).

DMX Control

The Projection Mode Channel is 8bit and the default value is set to 0.

Perspective Mode	0
Orthogonal Mode	1

5.4.7.2 VIEW POINT

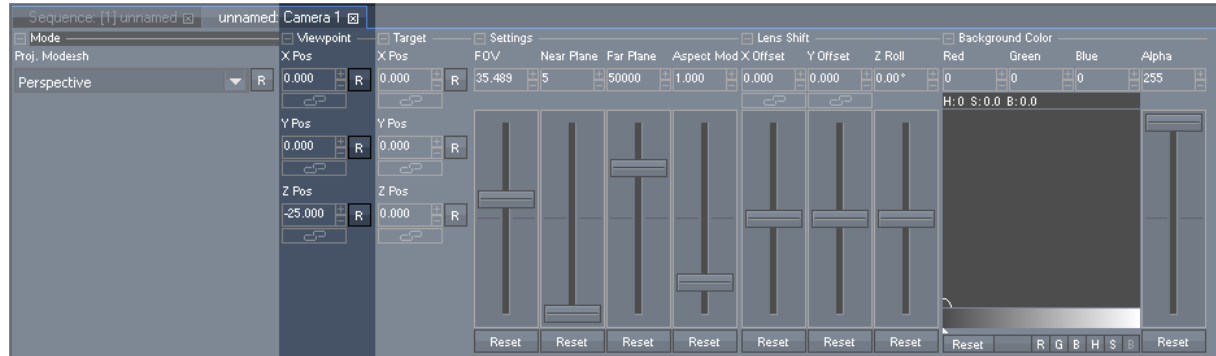

The viewpoint (only available for Servers) allows changing the camera's position in the 3D space without affecting its target. The default position of the camera is at (XYZ = 0,0,-25).

The output is always 16 units wide, the height is calculated by the aspect ratio.

A 4:3 display is 16 units wide and 12 units high, a 16:9 display is 16 units wide and 9 units high.

Example:

The viewpoint is changed to (XYZ = -8,4.5,-25), the camera's new position is orthogonal to the upper left corner of a 16:9 output. See how the viewpoint affects the output.

Camera Viewpoint: (XYZ = 0,0,-25)



Camera Viewpoint: (XYZ = -8,4.5,-25)

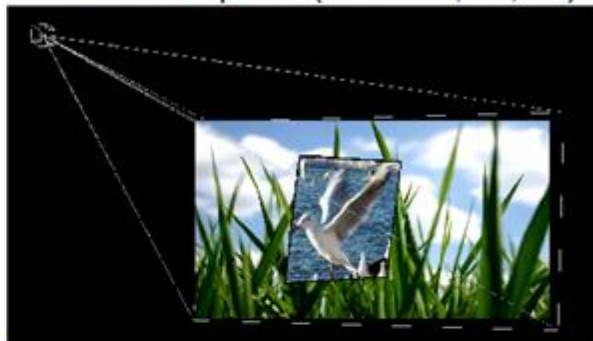

The images at the top show the 3D scene in the global cam preview: with default viewpoint (left) and with viewpoint changed to the new position (right). The images at the bottom show the resulting output: with default viewpoint (left) and with new viewpoint position (right).

**DMX Control**

All Viewpoint Channels are 16bit.

Resolution: 1DMX Step = 0.008 units

**X Position**

Default value: 32768

0	max. position left (-256 units or 16 screen width to the left)
32768	Center
65535	max. position right (+256 units or 16 screen width to the right)

**Y Position**

Default value: 32768

0	-256 units
32768	Center
65535	+256 units

**Z Position**

Default value: 29568

0	-256 units
32768	Center
65535	+256 units

**5.4.7.3 TARGET**



The target parameters (only available for Servers) allow changing the camera's target position in the 3D space without moving the camera itself. The output will show another detail of the 3D space and the perspective will be affected as well (as long as you do not work in Orthogonal Projection Mode).

The output is always 16 units wide, the height is calculated by the aspect ratio.

A 4:3 display is 16 units wide and 12 units high, a 16:9 display is 16 units wide and 9 units high.



Example:

The target position is changed from the default position (XYZ = 0,0,0) to (XYZ = -4.7,-1.3,0).

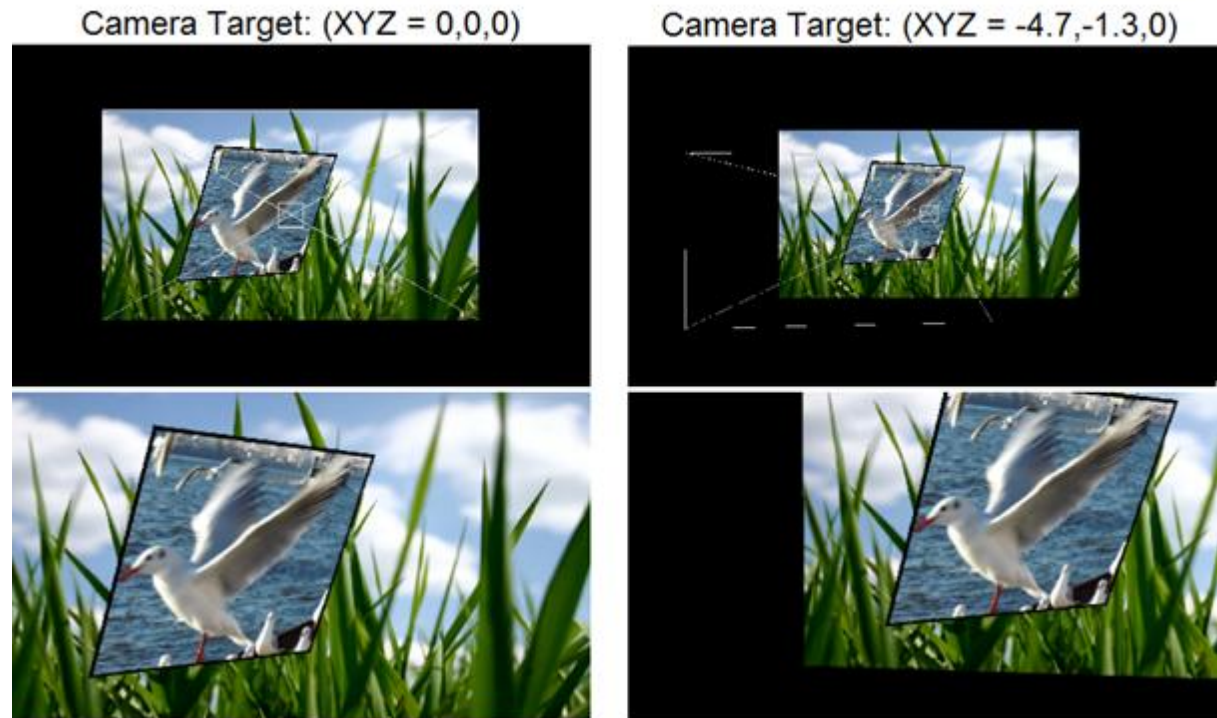

The images at the top show the 3D scene in the global cam preview: with default target (left) and with target changed to the new position (right). The images at the bottom show the resulting output: with default target (left) and with new target position (right).

DMX Control

All Target Position Channels are 16bit, the default value is 32768.

Resolution: 1DMX Step = 0.008 units

Target X Position

0	max. position left (-256 units or 16 screen width to the left)
32768	Center
65535	max. position right (+256 units or 16 screen width to the right)

Target Y Position

0	-256 units
32768	Center
65535	+256 units

Target Z Position

0	-256 units
32768	Center
65535	+256 units

### 5.4.7.4 SETTINGS

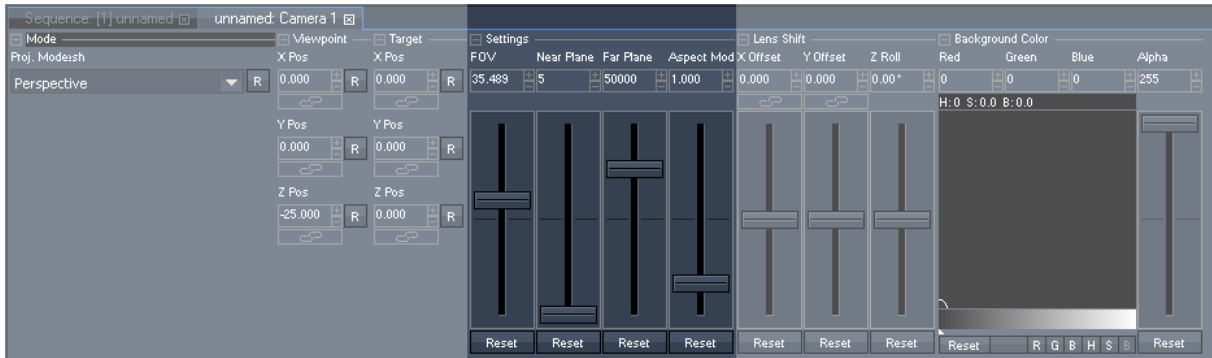

The Settings section allows adjusting the Camera's Field of View, the area in your 3D space that will be rendered (Near and Far Plane) and the Aspect Mode of the camera. Players have only access to the FOV parameter.

#### DMX Control

All Settings Channels are 16bit.

#### FOV (Field of View)

Default value is set to 17745.

0	0.001
17734	35.489
65535	131.070

#### Near Plane

Default value is set to 5.

0..65535	-256 units
----------	------------

#### Far Plane

Default value is set to 50000.

0..65535	
----------	--

#### Aspect Mode

Default value is set to 10924.

0	0
10924	1
32768	3
65535	6

### 5.4.7.5 LENS SHIFT

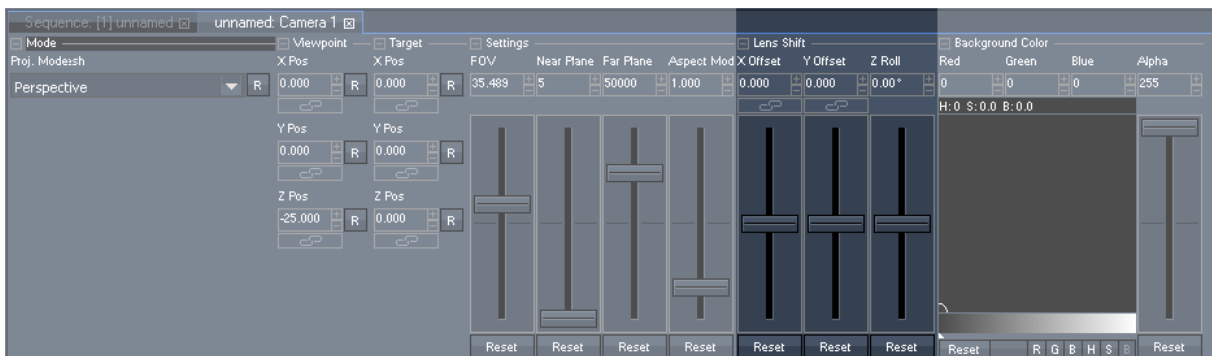

The Lens Shift section allows adjusting X and Y Offset as well as the Z Roll.

### X&Y Offset

The camera X&Y offset allows positioning the center of the cameras perspective. This is especially used when one perspective view needs to be shared across several outputs.

For example, if you have 4 screens set up next to each other, you would offset each screen in the way that you can move your layers with the XYZ position smoothly across all outputs, while maintaining a correct perspective 3D view.

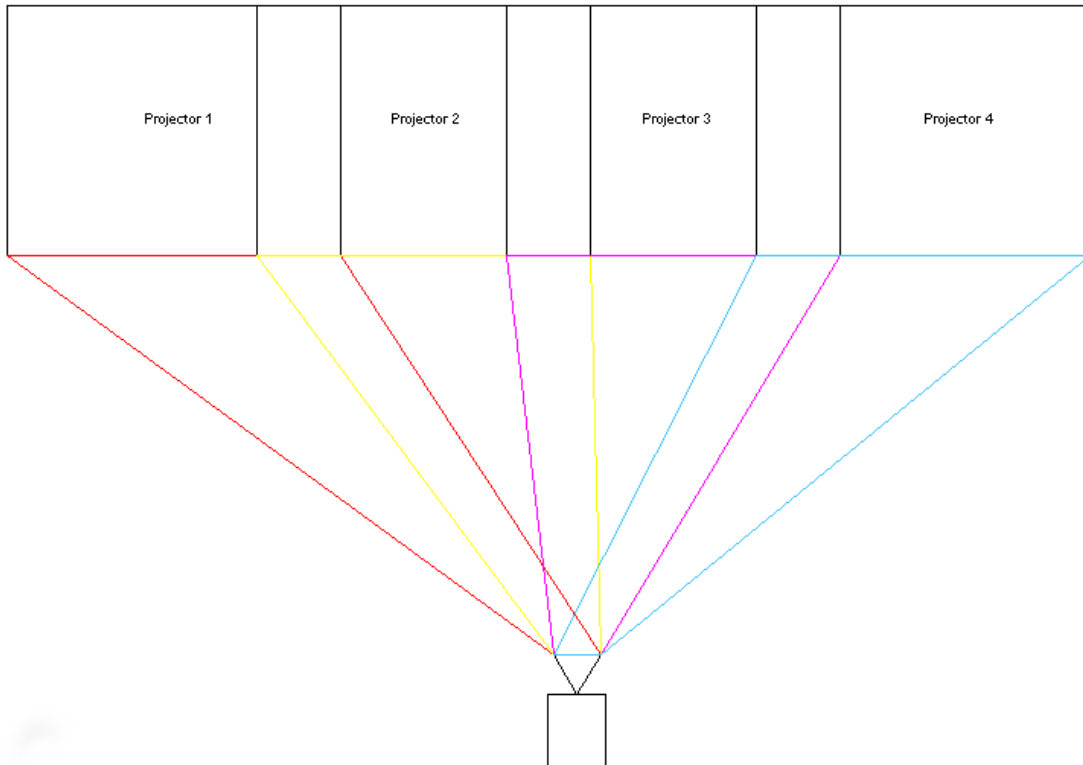

## Z Roll

The Z Roll allows rolling the camera across its Z Axis.

### DMX Control

All Lens Shift Channels are 16bit, the default value is set to 32768.

#### X Offset

0	-256 units
32768	Center
65535	+256 units

#### Y Offset

0	-256 units
32768	Center
65535	+256 units

#### Z Roll

0	-1080°
32768	0°
65535	+1080°

## 5.4.7.6 BACKGROUND COLOR

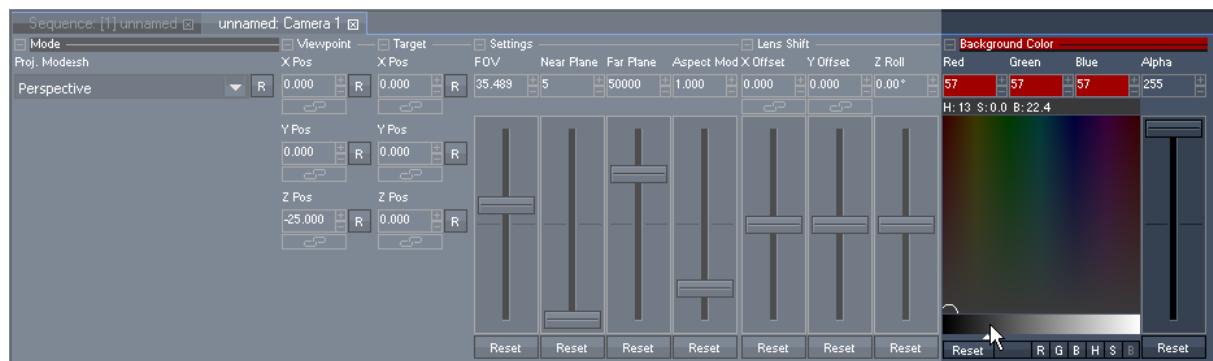

The Background Color section (only available for Servers) allows adjusting the red / green / blue / alpha channels for the main background from the resulting texture rendered by the camera (the so called render target). More information about the render target can be found in the chapter [V5 Video Processing Pipeline](#)<sup>297</sup>, a possible application for adjusting the background color could be [blacklevel compensation](#)<sup>613</sup> when working with multi-softedged projection(s). If you are not familiar how to use the color picker tool, please read the topic "[FX Parameter](#)<sup>323</sup>".

### DMX Control

All Background Color Channels are 8bit.

Red, the default value is set to 0

0...255	Red level, Color Picker
---------	-------------------------

Green, the default value is set to 0

0...255	Green level, Color Picker
---------	---------------------------

Blue, the default value is set to 0

0...255	Blue level, Color Picker
---------	--------------------------

Alpha, the default value is set to 255

0...255	Alpha / transparency level
---------	----------------------------

### 5.4.8 OUTPUT CONTROL

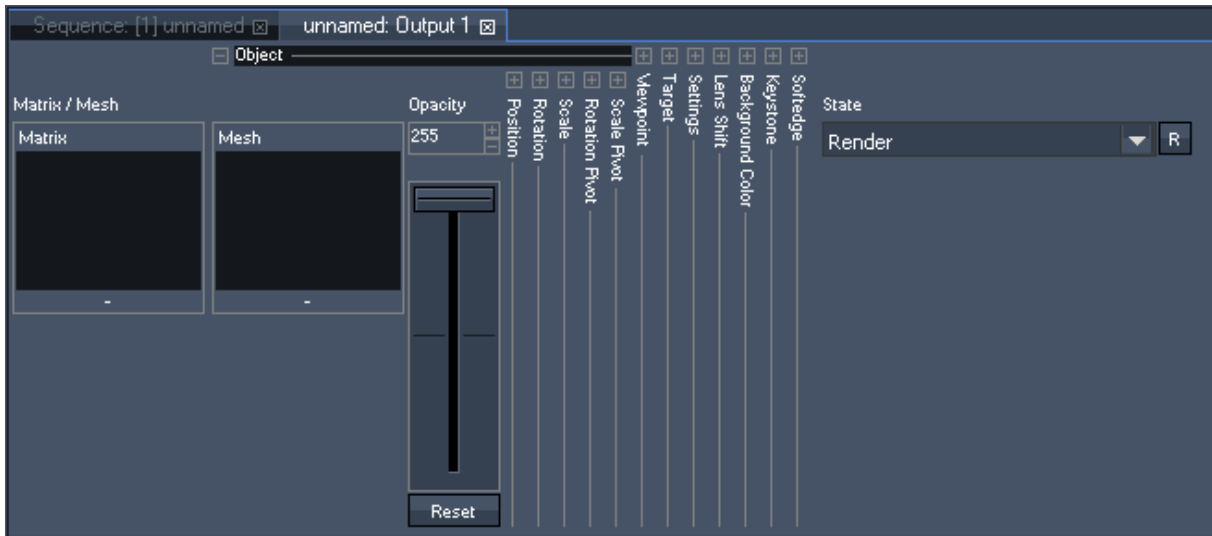

The output device is the device that controls the overall output of the Pandoras Box Server or Player. Here you may add a matrix file and a 3D / Warping object, adjust keystone and softedge settings. You may add FX for i.e. a color correction of the whole output!

The camera control is the first render path. The result of this camera filming your 3D composition is passed to the output control, which is the second render path. The passes are described in detail in the chapter "[V5 Video Processing Pipeline](#)<sup>297</sup>".

The output control section is divided into the following chapters. Information about DMX Control is included, addressing customers who wish to remote control a layer with a lighting desk via DMX or Art-Net. If you like to use the Widget Designer or another application instead, please refer to [this parameter list](#)<sup>1258</sup>.

- [Matrix](#)<sup>598</sup>
- [Object](#)<sup>599</sup>
- [Viewpoint](#)<sup>600</sup> (only available for Servers)
- [Target](#)<sup>601</sup> (only available for Servers)
- [Settings](#)<sup>601</sup> (only available for Servers)
- [Lens Shift](#)<sup>602</sup> (only available for Servers)
- [Keystone](#)<sup>603</sup> (not for Player STD + Player LT)
- [Softedge](#)<sup>604</sup> (not for Player LT)
- [Render State](#)<sup>606</sup>
- [FX](#)<sup>607</sup>

### 5.4.8.1 MATRIX

With the matrix section you may use Pandoras Box to output the pixels RGB(W) or CMY color information over Ethernet via the Art-Net protocol in addition to the normal DVI video output. This allows you to sent color information to specific lamps or Art-Net based LED walls. More detailed information can be found in the chapter "[Matrix Patcher](#)<sup>757</sup>" as well.

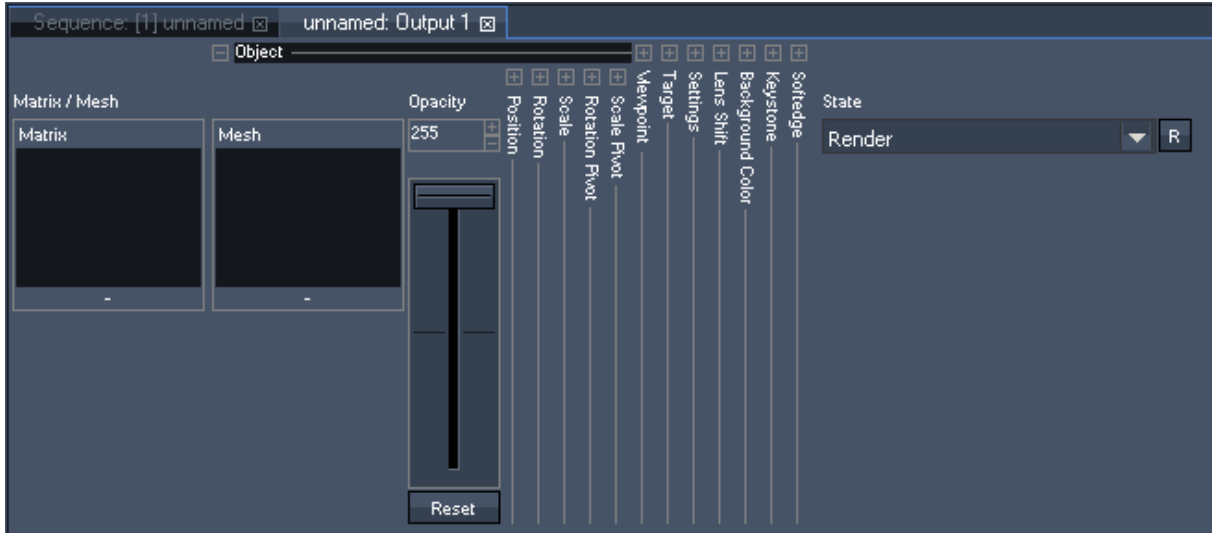

#### Matrix

The Matrix field accepts either outdated csv files or the newer pbx files that are part of the project already. Of course each client in your PB network may be programed with different matrix files. In addition they can be saved on the timeline and may change throughout the show.

Use the right-click menu in the [preview](#)<sup>234</sup> to visualize the matrix files. If changes are needed, select the matrix file in the Project tab and choose to edit it with the Matrix Patcher, alter the patch and update it in real-time.

Please note, that effects dragged onto the output layer cannot be considered by the patch file, thus you will not see output effects on your DMX panels.

#### Creating a matrix file

First of all, use the Matrix Patcher to define the entire pixel workspace that you want to use and patch the fixtures to the DMX channels and subnet addresses. You can either make use of predefined fixture within the library or create individual lamp/wall types and use them as templates for your custom matrix design. You can use RGB or CMY mixing devices.

The topic [Matrix Patcher](#)<sup>757</sup> has further information and a [patching guide](#)<sup>770</sup>.

The limitation regarding how many pixel data in form of Art-Net universes can be transferred is a question of your network components and receiving devices. As a rule of thumb, we do not recommend to output more than 60 universes per network.

Per default, Art-Net is set up as a broadcast protocol; nevertheless, using the Matrix Patcher, you have the option to use the transfer rate of each transmitting and receiving device to its full capacity by sending the pixel information more efficiently with the multi- or even unicast method.

There are certain network switches like the ones from ELC that support DMX lines and dedicated Art-Net routing. If you need more information concerning these devices please contact your local ELC Dealer.

### 5.4.8.2 OBJECT

The object section allows controlling the overall opacity of the output, setting a 3D / Warping object or patch file as well as adjusting its position, scale and rotation state.

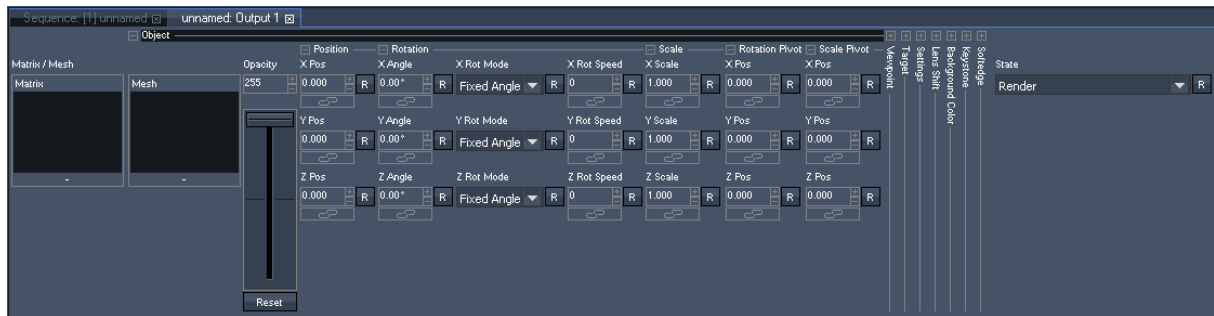

#### Object Selection

The camera allows the selection of the same object as for the layers. The big difference is that the overall rendering will now be displayed on the selected object depending on its texture mapping. You may consider the use of an object with the camera as an image filter that is applied to the overall rendering of each individual output.

This feature may be used as visual effect or to select specific objects that allow keystone correction on any curved or non-planar screen.

To assign an object to the output, drag and drop the resource from the project tab onto the designated output. You may also highlight the target output by left-clicking on it and use the right-click command on the resource in the project tab “assign to active device” or just double-click on the object file.

To remove the resource from the output, right-click in the layer tree on the object parameter and choose “reset”.

To create a keystone object, we recommend creating it with the [Warper](#)<sup>780</sup> or another [third party software](#)<sup>1592</sup> (3D Studio Max or its freeware version GMAX). Once you have set up the object according to your screen, you can export it to Pandoras Box and use it individually for each output.

For DMX control depending on the ID assignment in the Pandoras Box master user interface, each layer can access 255 folder and 255 file IDs of individual object files.

Object file selection set to 0% (000dec.) selects “no file”.  
The object channels are 8bit, the default value is set to 0.

#### Object Folder

0	No folder
1..255	Folder 1..255

#### Object File

0	No file
1..255	File 1..255

## Opacity

The opacity sets the overall output brightness level as well as the overall audio level.

Opacity 0%                      black, no output / no sound  
 Opacity 100%                full brightness / 1:1 sound level

DMX Control

Opacity

0..255	Fully transparent..Fully visible
--------	----------------------------------

## Position, Rotation, Scale (Server only)

The 3D / Warping Object may be adjusted in its position and scale and may be rotated.

Please see the according chapters under [Video Layer Control](#)<sup>298</sup>, as all outputs position, rotation and scale parameters work the same way.

### 5.4.8.3 VIEW POINT

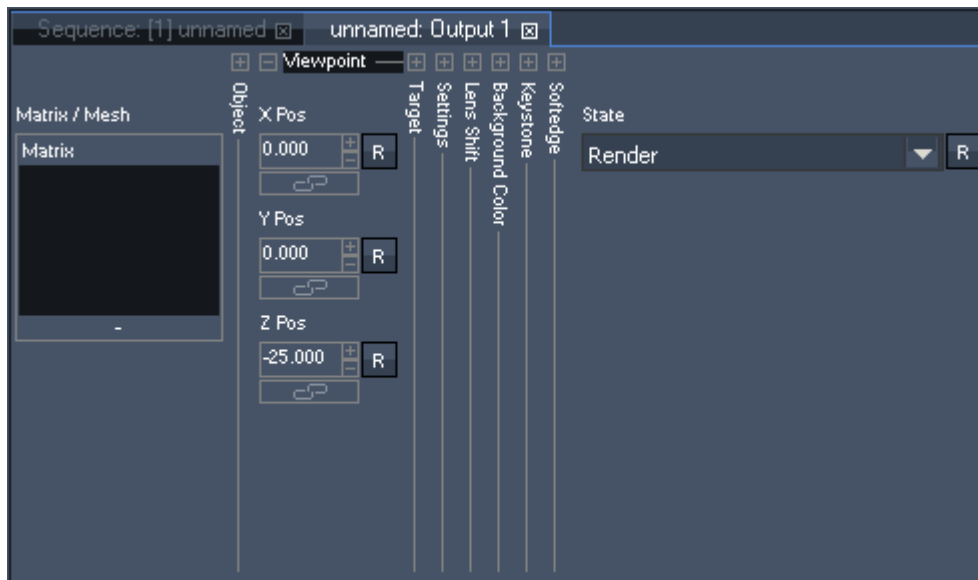

The view point (only available for Servers) allows changing the position from where the output (which can be seen as a second camera that passes its result to the graphics card) looks at the camera texture. The default position of the output (-camera) is at (XYZ = 0,0,-25).

Please note:

Typically the view point option will not be used in 99% of all cases. Advanced users only!



### 5.4.8.4 TARGET

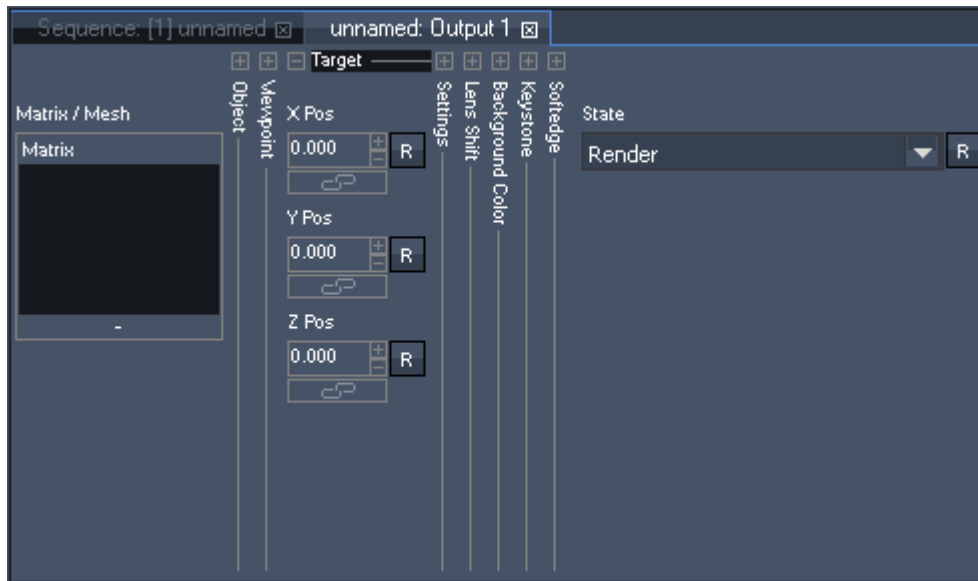

The target parameters (only available for Servers) allow changing the position of the target which the output (that can be seen as a second camera that passes its result to the graphics card) is looking at. When not changed, the target is the whole camera texture.

Please note:

Typically the target positions will not be used in 99% of all cases. Advanced users only!

### 5.4.8.5 SETTINGS

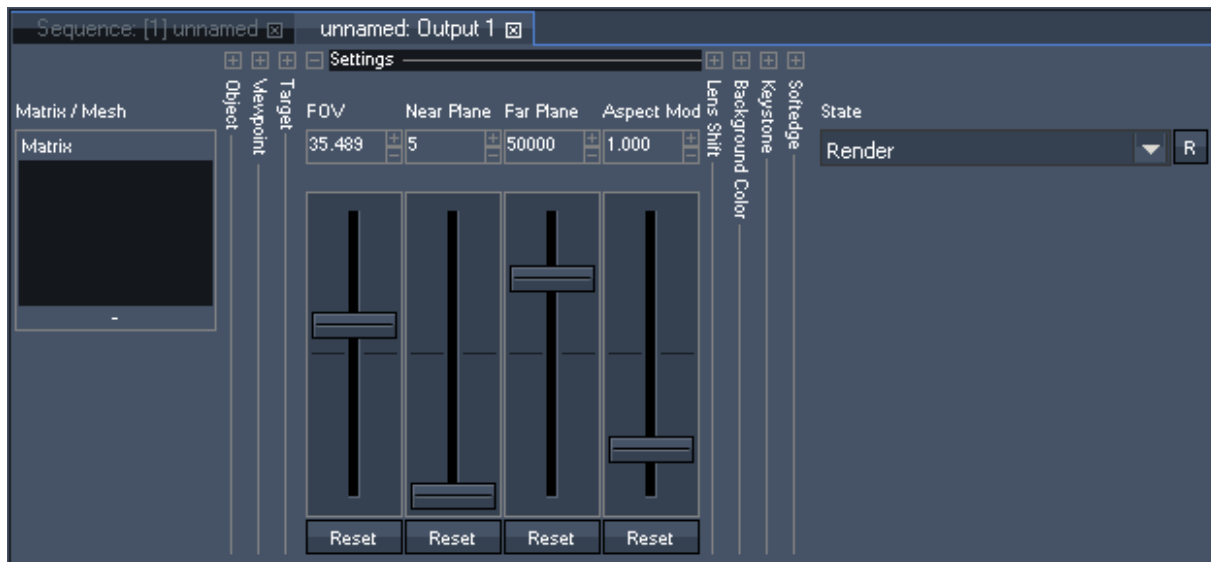

The Settings parameters are only available for Servers. Please refer to the topic "[Settings](#)<sup>594</sup>" in the Camera chapter.

Please note:

Typically the setting options will not be used in 99% of all cases. Advanced users only!

### 5.4.8.6 LENS SHIFT

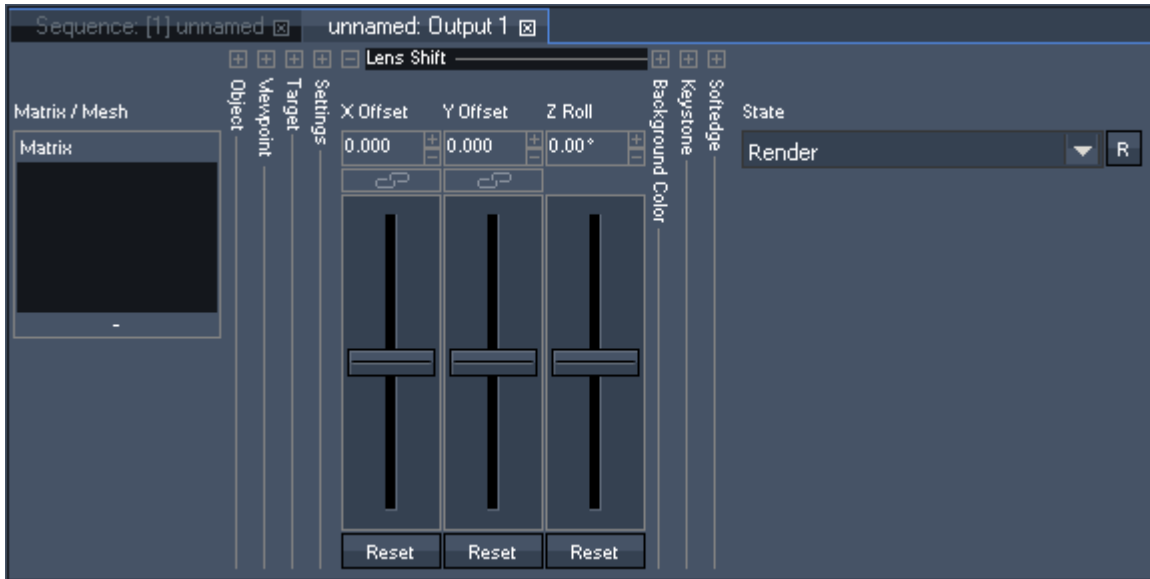

The Lens Shift parameters are only available for Servers. Please refer to the topic "[Lens Shift](#)<sup>594</sup>" in the Camera chapter.

Typically the lens shift option on the output will not be used in 99% of all cases. Advanced users only!

For softedge projections:  
Please use the [Lens Shift](#)<sup>594</sup> parameters on the camera control to adjust which part of the 3D space each output will show!

### 5.4.8.7 BACKGROUND COLOR

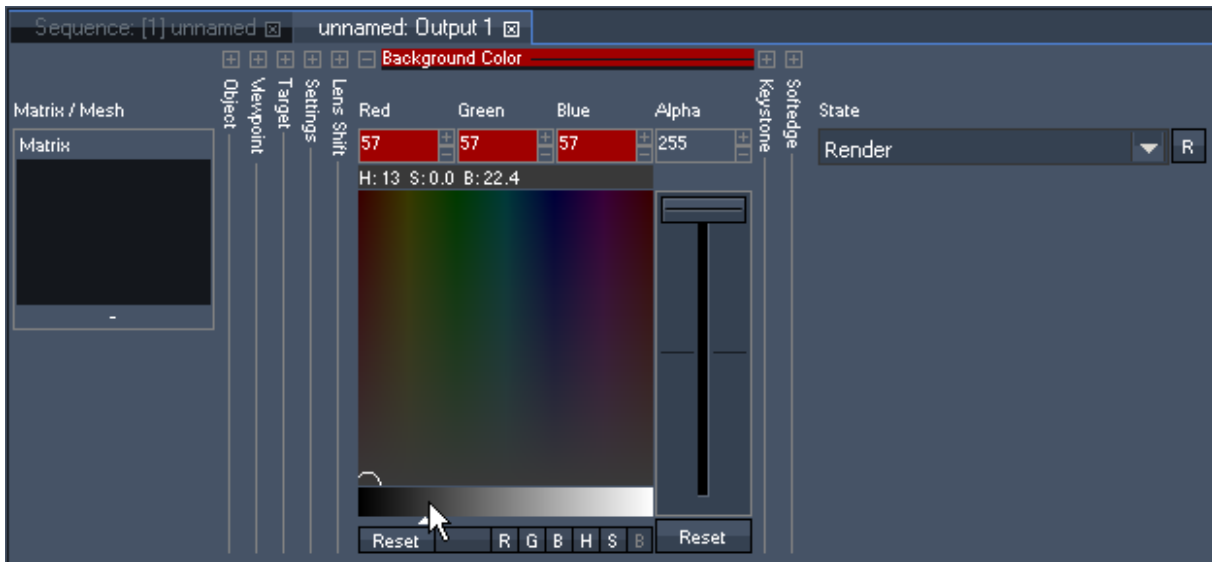

The Background Color section (only available for Servers) allows adjusting the red / green / blue / alpha channels for the main background from the resulting backbuffer texture rendered by the graphic card. More information about the backbuffer can be found in the chapter [V5 Video Processing Pipeline](#)<sup>297</sup>, a possible application for adjusting the background color could be [blacklevel compensation](#)<sup>613</sup> when working with multi-softedged projection(s). If you are not familiar how to use the color picker tool, please read the topic "[FXParameter](#)<sup>323</sup>".

Please note: If you like to use the alpha fader, i.e. clear the backbuffer with the transparency channel, you need to enable this feature first. This can be done either in the [Configuration tab's](#)<sup>139</sup> section called [Local Engine Settings](#)<sup>158</sup> or, if working with a client in its [Inspector](#)<sup>206</sup>.

**DMX Control**

All Background Color Channels are 8bit.

**Red**

The default value is set to 0

0...255	Red level, Color Picker
---------	-------------------------

**Green**

The default value is set to 0

0...255	Green level, Color Picker
---------	---------------------------

**Blue**

The default value is set to 0

0...255	Blue level, Color Picker
---------	--------------------------

**Alpha**

The default value is set to 255

0...255	Alpha / transparency level
---------	----------------------------

**5.4.8.8 KEYSTONE**

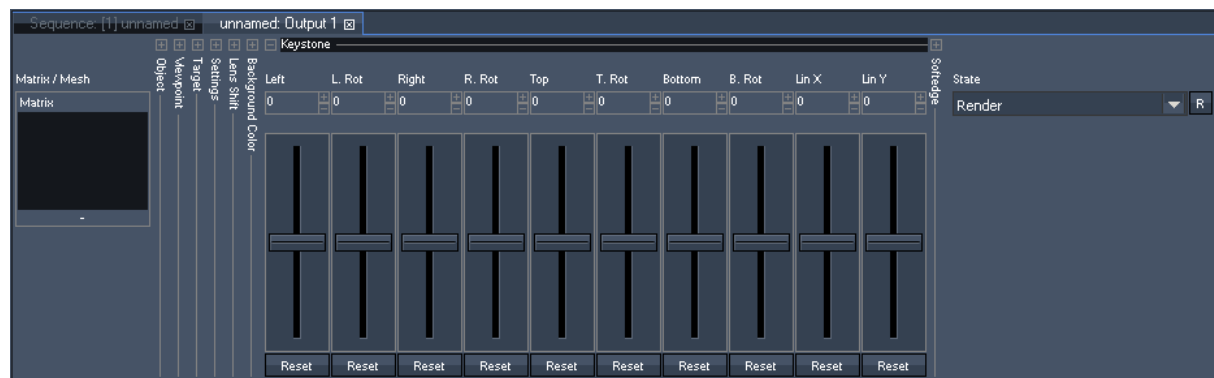

The keystone function of the Pandoras Box Server and Player PRO is a powerful feature for planar projection.

It is designed in the way that it can be operated as standard beam shapers. Each output edge can be moved in or out and rotated according to the projection surface. Please note that it is not possible to keystone an image if an object is used as the object already deforms the camera texture.

Once you have set up each edge, you might compensate for the linearity distortion with the X&Y Keystone parameters. To do this, use a raster grid test pattern on a layer and reset the image center with the X&Y channels.

### 5.4.8.9 SOFTEDGE

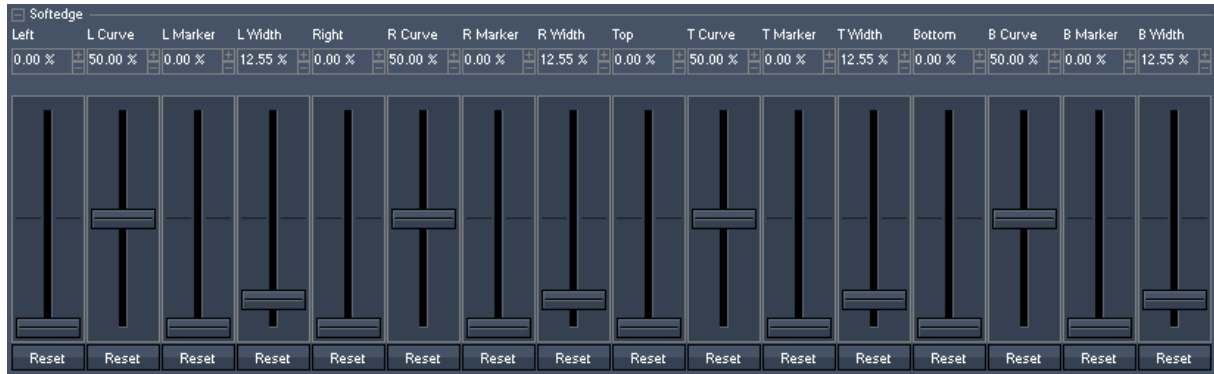

Pandoras Box Servers and most Players feature a four sided image blending for any output configuration. Softedge allows smooth image blending of multiple projectors.

#### Overlap

Traditionally, the overlap was an important information for anybody who wanted to create images for softedge projection. The amount can still be important depending on the setup of your softedge.

The overlapping area is that part of the projection, where the projected images of two projectors share the same image information to create a smooth image-blending from one projector to the other.

Due to the physical setup of the projectors - their light output and contrast - the overlapping has to be adjusted carefully to match a seamless image.

Pandoras Box softedge feature allows a variable overlap between 0% and 100% of each image edge.

Each edge (left/right, top/bottom) has its own softedge gradient with an individual gradient curve control for the light falloff of the projector.

#### Creating content for softedge projections

In general, for an optimum image quality, the best way is to create two parts of an image: a left part for the left projector and a right part for the right projector.

But if you would like to move a layer across the two projectors you will need to stretch the content and use the same image for both projectors and match them by X&Y positioning on top of each other.

It is also possible to use both methods in the same show, i.e. having overlapping content and stretched content in the same timeline but different layers.

#### Softedge setup

After setting up the projectors properly (matching the raster, size and keystone) the overlapping edges need to be blend together. The best way to do this is by using a test-pattern with text and positioning it precisely on top of each other. Now you may bring the soft edges in and adjust the curves until there is no more hotspot area.

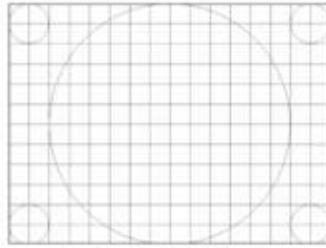

Softedge Default

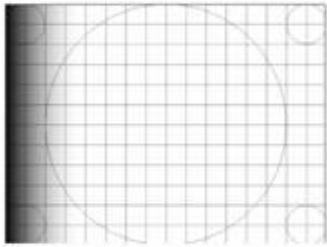

Softedge Left Curve out

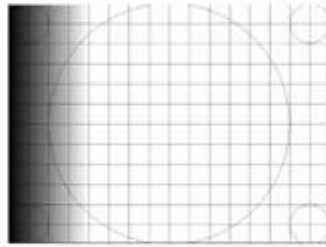

Softedge Left in

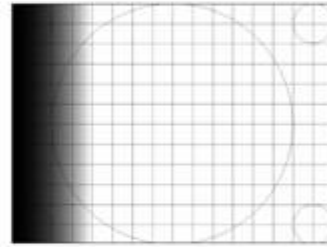

Softedge Left Curve out

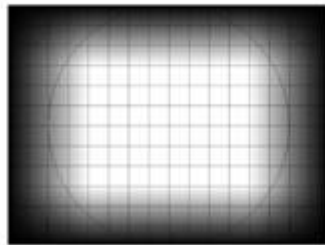

All Softedges in

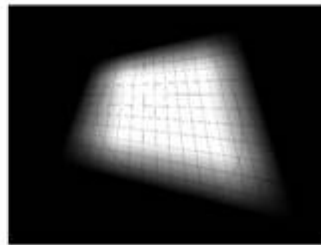

Keystone with Softedge

DMX Control

For each edge (left, right, top and bottom) you have the possibility to set up the following parameters:

Parameter (Alias within GUI)	Name for external Control (e.g. Widget Designer, SDK)	Description	Value Range	Default
Left	SE L	Amount of softedge left	0-65535	0
L Curve	SE LC	Individual gradient curve	0-65535	32768
L Marker	SE L Marker	Marker for left softedge: 0=no marker 1 - 255 = black marker - white marker	0-255	0
L Width	SE L Width	Width of left marker	0-255	32

The parameters Left, L Alpha, L Marker and L Width and its values will be repeated for all other edges: Right (R), Top (T) and Bottom (B).

The values may be displayed in percentage read-out as well, see [configuration tab](#)<sup>[139]</sup>.

**Please note:** Softedge always affects the whole output and will be adjusted automatically according to the keystone settings or the applied mesh.

5.4.8.10 RENDER STATE

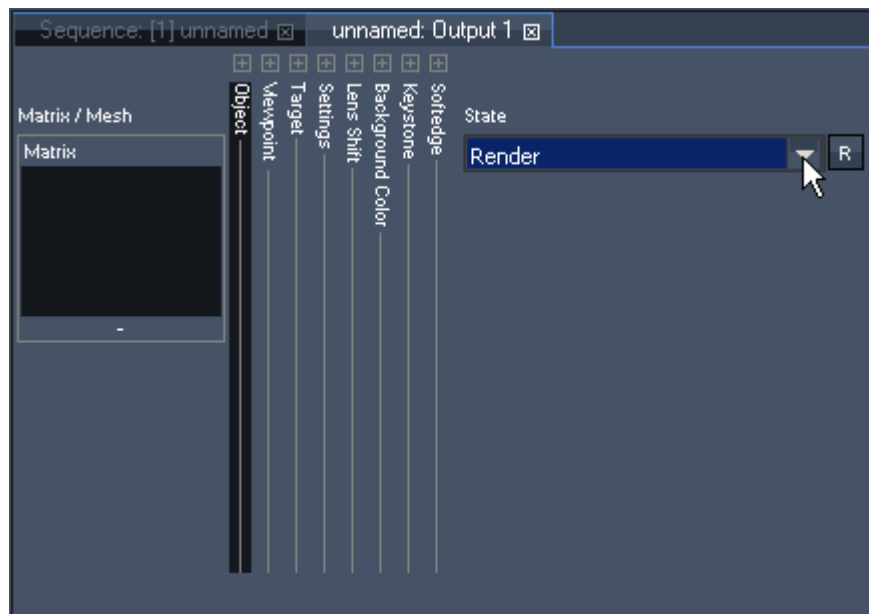

By default the State of the Output Control is set to "Render". That means the output is working as a second render path, all settings done in the output control will affect the camera result.

When the state is changed to "Bypass" **all settings** done in the output (like the object, keystone and softedge) will be ignored to gain the highest rendering performance. This mode might be used in setups where no keystone or screen warping is needed and highest image rendering quality is required.

### 5.4.8.11 FX

The new dynamic shader effects engine allows creating and combining an almost unlimited number of effects. All effects and animations are automatically synchronized across the system network.

FX can be used on the output control device like on a video or graphic layer. The difference is that these FX will influence the overall output instead of only the layer.

Example: It could be very helpful using color correction FX on the output to compensate color corruptions of displays or projectors.

Please refer to the section [FX](#)<sup>319</sup> in the chapter [Video Layer Control](#)<sup>298</sup> for further information.

## 5.4.9 DMX DEVICES

All Pandoras Box Systems feature DMX device control. This is especially useful for synchronized control of moving video projectors and the dynamic keystone correction of Pandoras Box. Furthermore it's used for installations where DMX needs to be programmed in sync to the video playback.

On the one hand, it is possible to [input DMX](#)<sup>621</sup> and remote control layers by an external lighting desk. On the other hand, Pandoras Box features [DMX output](#)<sup>642</sup> as well. This way you may include DMX devices into the timeline and control them with parameter keys in the same way as controlling video layers.

To input or output DMX you can either use the coolux [DMX Link](#)<sup>735</sup> or devices that convert the data to ethernet, like the [DMX Link 8](#)<sup>736</sup> or others.

Pandoras Box features both 8bit and 16 bit DMX parameters and supports the protocols DMX, Art-Net, MA-Net and sACN.

As said above, to output DMX data to a device, it needs to be part of the timeline. As explained in the following two chapters, you may choose your DMX device from the [built-in device list](#)<sup>607</sup> or [create a custom device](#)<sup>608</sup> as XML file for DMX control.

### 5.4.9.1 BUILT-IN DMX DEVICES

All Pandoras Box systems ship with a built-in DMX device list. You may access it in the [Device Type tab](#)<sup>181</sup> and add your device to the [Device Tree](#)<sup>168</sup>.

If your device is not included in the list, please read the following chapter about [custom DMX devices](#)<sup>608</sup>.

The chapter about [DMX output](#)<sup>642</sup> explains how to patch a device, configure the output protocol and finally, send data.

### 5.4.9.2 CUSTOM DMX DEVICES

As said in the previous chapter, all Pandoras Box systems ship with a [built-in DMX device list](#)<sup>607</sup>. If your device is not included in the list, you may create a custom file and add it to the [Device Type tab](#)<sup>181</sup> as explained below. Afterwards, please follow the chapter about [DMX output](#)<sup>642</sup> that explain how to patch a device, configure the output protocol and finally, send data.

A custom DMX library file can be created as a text file with WordPad. The file needs an extension called ".clib" and needs to be stored in the installation folder of the Master under: "\data\types\DMX Fixtures".

Please find here an example of a DMX .clib file for a Martin MAC500:

```
<?xml encoding="yes" ?>
<descripDevice type="fixtureDmx" artNetIndexScope="16">
<descripModule type="param8bit" name="STROBE" default="34" artNetIndexOff="0" />
<descripModule type="param8bit" name="DIM" default="0" artNetIndexOff="1" />
<descripModule type="param8bit" name="COLOR1" default="0" artNetIndexOff="2" />
<descripModule type="param8bit" name="COLOR2" default="0" artNetIndexOff="3" />
<descripModule type="param8bit" name="GOBO1" default="0" artNetIndexOff="4" />
<descripModule type="param8bit" name="GOBO1 ROT" default="0" artNetIndexOff="5" />
<descripModule type="param8bit" name="GOBO2" default="0" artNetIndexOff="6" />
<descripModule type="param8bit" name="FOCUS" default="50" artNetIndexOff="7" />
<descripModule type="param8bit" name="IRIS" default="0" artNetIndexOff="8" />
<descripModule type="param8bit" name="PRISMA1" default="0" artNetIndexOff="9" />
<descripModule type="param16bit" name="PAN" default="32768" artNetIndexOff="10" />
<descripModule type="param16bit" name="TILT" default="32768" artNetIndexOff="12" />
<descripModule type="param8bit" name="SPEED1" default="0" artNetIndexOff="14" />
<descripModule type="param8bit" name="SPEED2" default="0" artNetIndexOff="15" />
</descripDevice>
```

As you can see the first line gives the general device description and the overall DMX channel count "artNetIndexScope=".

The following lines describe each DMX channel of the fixture by a zero based offset of the DMX channel count at the end of each line by "artNetIndexOff=".

You may also choose the type of parameters "param8bit" or "param16bit" as well as setting the descriptive name and reset and default value.

### 5.4.10 SERIAL LINK DEVICE

With the Serial Link device you may control most routing switchers, projectors, shutters or other device parameters that are remote controllable via the common RS 232 and 422 serial protocols. Simply add the serial command according to the device's syntax as a key to the timeline.

Even though, the device's name is Serial Link, you do not necessarily need the [hardware device itself](#)<sup>729</sup>. For more information on the connection to the Serial Link hardware, please read these chapters: [Serial Link input](#)<sup>640</sup> and [Serial Link output](#)<sup>643</sup>.

If you like to control another hardware, please see here an example regarding a projector: [Output Protocols > TCP/IP](#)<sup>644</sup>.



### 5.4.11 SONIC EMOTION

#### MULTI-CHANNEL AUDIO

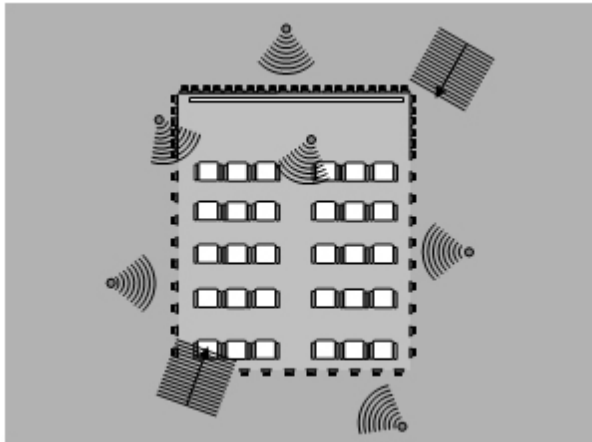

The optional multichannel audio plug-in integrates up to 16 channels of synchronized audio.

When using the Sonic Emotion stereo audio device please use only: Mono wav files at 48kHz, 16 bit.

With the Sonic Emotion 16CH device, mono wave files with 48 kHz, 16 bit can be uploaded and synchronized to the Pandoras Box Timeline Playback. To access it, drag the device from the tab Device Types into the tab Device Tree. The available controls are depicted below. If you like to interact with the device whilst using a custom application ([SDK](#)<sup>1532</sup>) or the Widget Designer, please refer to this [parameter list](#)<sup>1259</sup>.

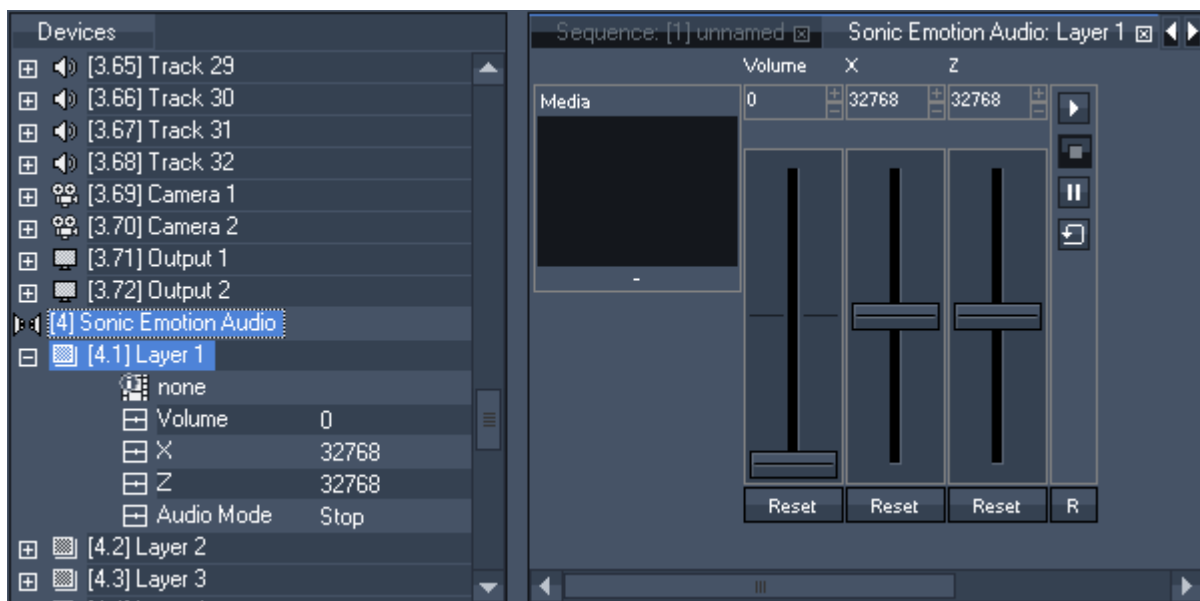

The audio can be interfaced with audio processors of our partner Sonic Emotion ([www.sonicemotion.com](http://www.sonicemotion.com)) that provide spatial placing through their patented Wave Field Synthesis.

### 5.4.12 WIDGET DESIGNER DEVICE

This topic explains how to add a Widget Designer Device to the Device tab allowing to:  
 - program Widget Designer commands directly in timeline

- send (trigger or feedback) values from the timeline to Widget Designer
- send mouse and touch input events from an attached Client to Widget Designer

[Widget Designer](#)<sup>864</sup> is another coolux software product. One of the main purposes of Widget Designer is to enable users who do not have any programming skills, to create their own custom applications or interfaces. Widget Designer provides a graphical user interface and runtime environment. You can create user-controls such as faders, buttons, labels and many more and instantly use them. The PRO version allows to program visually with so called nodes. By simply connecting those visual control components you may create a dedicated interaction logic. In addition WD has a built-in script language allowing you to create customized routines of commands. For example, a command can be assigned to a button click. Currently there are over 1000 commands that control specific features of Pandoras Box, Widget Designer or other 3rd party products and protocols. There are topics explaining [how to use commands](#)<sup>1254</sup> and containing the entire [command list](#)<sup>1260</sup>.

If you like to execute commands at a defined time within the timeline you can simply add the Widget Designer Device to the Device Tree tab and then program keys directly into the timeline, just as you would add keys for a Video Layer's position for example. If you are not familiar with the timeline and key programming, please read the topic "[Sequence](#)"<sup>260</sup>.

The second purpose of a Widget Designer Device is to route mouse / touch input from the PB Master or even PB Client to Widget Designer itself. This is described step-by-step in the [Layer picking chapter of the Preview](#)<sup>244</sup>. If you like to route this data to a Canvas asset in order to draw on it, the node "[Layer UV Draw to Canvas](#)"<sup>1150</sup> is of interest. Its chapter includes a step-by-step description of all necessary settings in WD and PB. You can also use the data to click on [Custom Script Buttons](#)<sup>884</sup> as described in its chapter.

Please follow these steps to set up a Widget Designer Device:

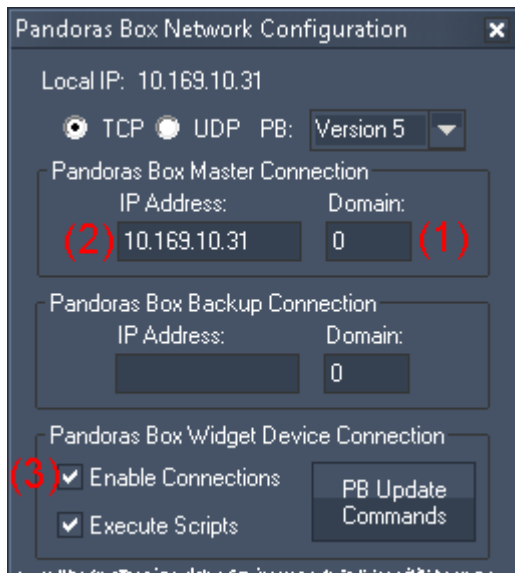

First of all, start the Widget Designer 4.0 and enable the connection to a Widget Designer Device in Pandoras which we will set up in the next step.

To do so, right-click in the main window and choose "[Pandoras Box IP Configuration](#)"<sup>865</sup>. Then make sure that the Domain (1) and IP address (2) under "Pandoras Box Master Connection" matches with the PC where Pandoras Box Manager or Player /Server as master is running on. In Pandoras Box, the IP address is shown in the Assets tab, the Domain in the Configuration tab.

Have a look in the section "Pandoras Box Widget Device Connection" and enable the check box "Enable Connections" (3). You can close the dialog.

As an example, please create a fader. Again, right-click in the main window to call the main context menu. Choose Create > Fader Controls > Fader Vertical and make one left-click into the main window. You have now created a fader with the default settings: ID = 1, minimum value = 0 and maximum value (also current value) = 255 .

So far, everything is set up in Widget Designer, please switch to your Pandoras Box master software.

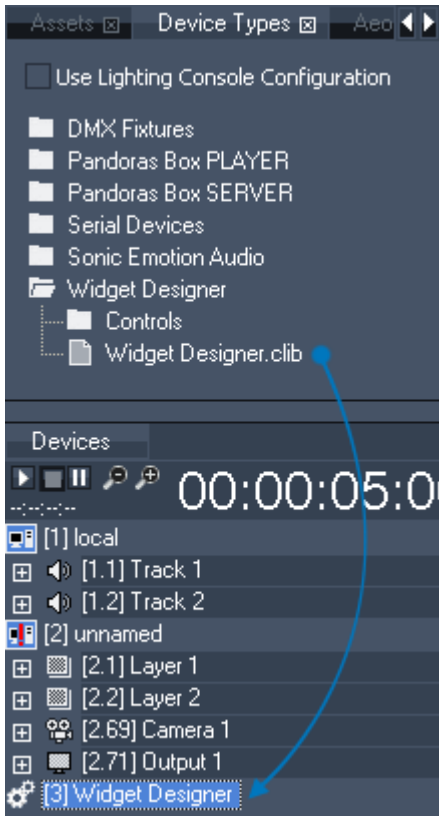

After creating a project, you can add a WD devices to it. For this, go to the "Device Types" tab > "Widget Designer" > and drag the "Widget Designer.clib" into the Device Tree tab.

As we have already set up the WD in the first step, the device can connect successfully.

If you see a red exclamation mark in the symbol within the Device Tree (as shown in the left image for the server device), check the IP address and domain number (in the Configuration tab). If the Widget Designer runs on a different PC, the Widget Designer device must be set to the according IP address. Select the Widget Designer device in the Device tab and edit the text field "IP" within the Inspector tab.



To send commands from the timeline double-click "Widget Designer" in the Device tab, and then "Script" as well. You should see the parameter "Command" whereto we will now program a key.

Make a right-click into the timeline at the height of the command parameter, as seen in the left image.

To assign a command to this key select it and switch to the Inspector tab.

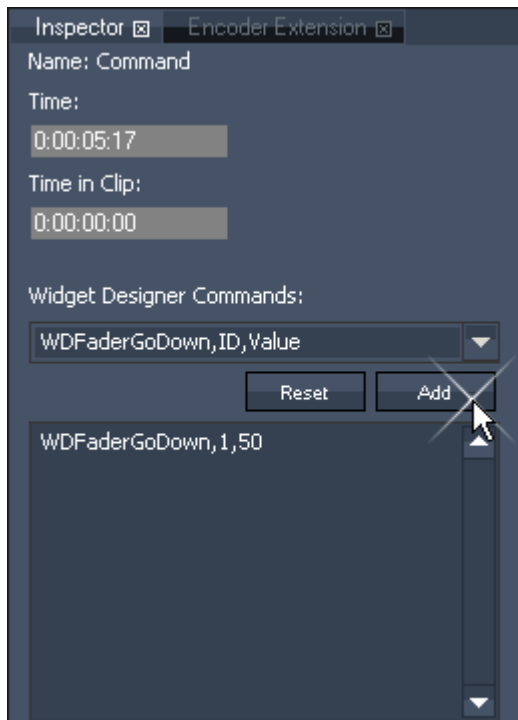

In the key's Inspector, choose a command from the drop-down list and paste it into the text field by pressing Add. Mostly, a command consists of several arguments separated by a comma - the first one always describes the command function the following ones are variables. Substitute them with according values.

Let's say, we want the fader created in Widget Designer in the very first step to lower its value by 50 steps.

The command to add is:  
WDFaderGoDown,ID,Value.

As the ID is 1 and the value to deduct is 50, the customized command in the text field should be:  
WDFaderGoDown,1,50

As soon as the nowpointer in the timeline passes the key, the command is executed and the fader will go down 50 steps.

If you like to execute more than one command press carriage return and add another one. There is the possibility to work with [macros](#)<sup>1191</sup> as well.

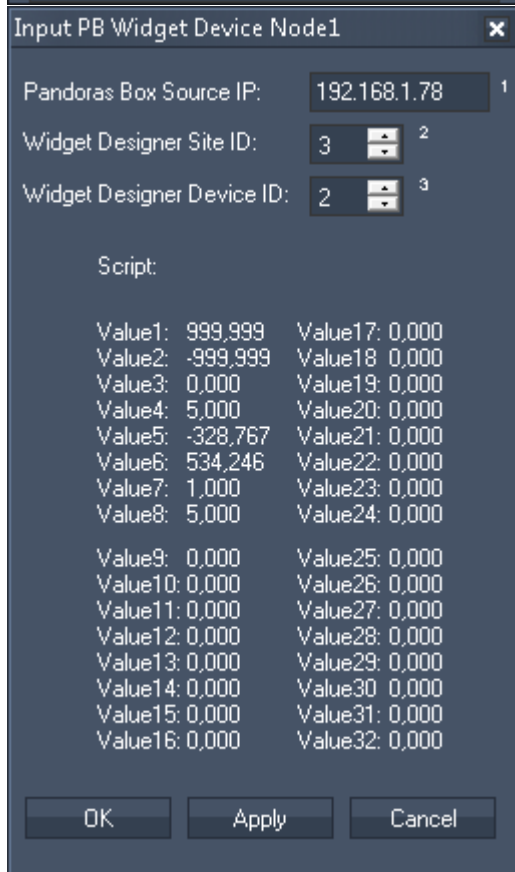

More advanced users who have a Widget Designer PRO version may use another feature that allows to send (trigger) values to WD.

- in the Device Types tab open the Widget Designer folder and drag "Values.clib" onto the Widget Designer site in the Device Tree tab. Now the WD site offers one script device with the command parameter and a new values device with eight value parameters (each with a value range from -999.999 to +999.999)

- program keys either by right-clicking in the timeline as described in the example above. Or, you switch over to the Device Control tab and then store active values

- in Widget Designer, press Alt+N to create a [node](#)<sup>959</sup>:  
Nodes > Input > Pandoras Box > Widget Device in order to retrieve the values and send them to filter nodes or directly to output nodes

- in the node's Item Properties dialog, adjust the IP address, the site and device ID. Following the example above, the site ID is 3 and the device ID refers to the newly generated value device, in this case number 2

### 5.4.13 BLACKLEVEL COMPENSATION

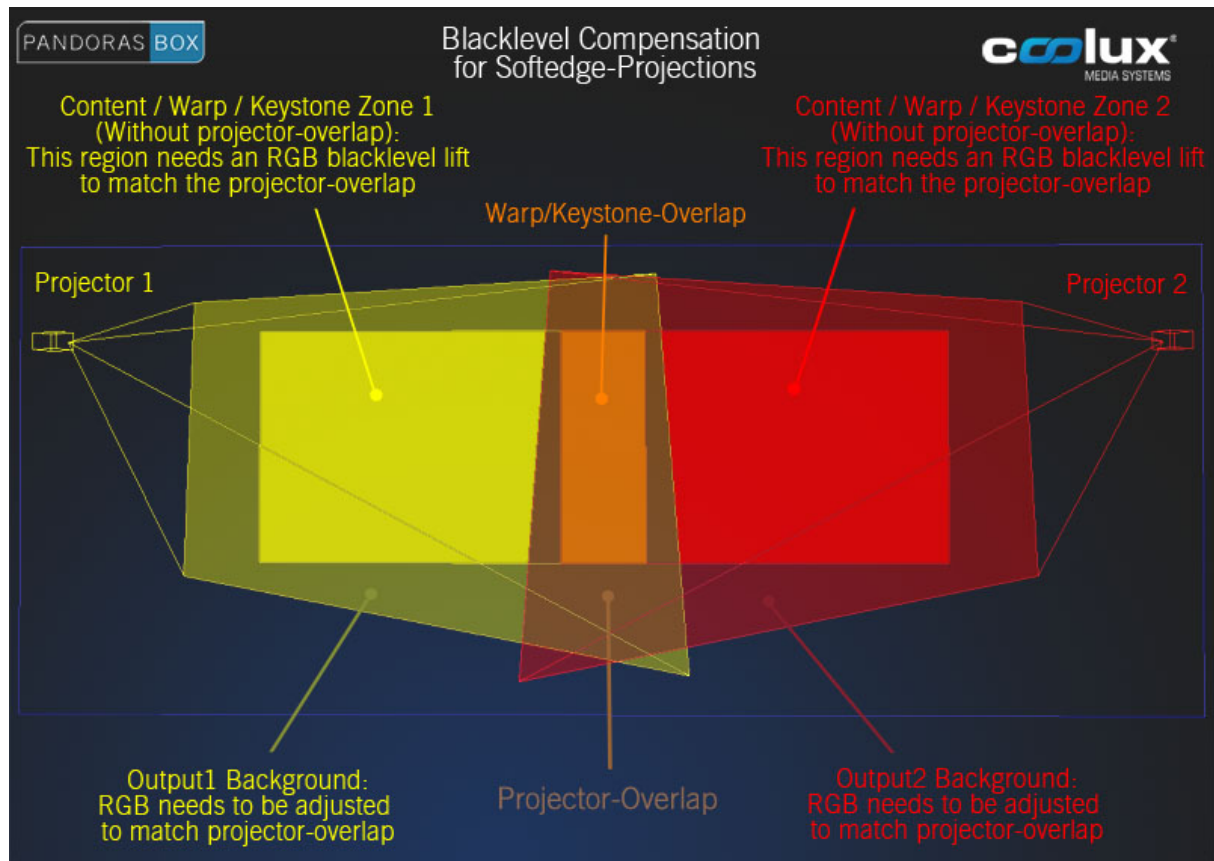

- blacklevel compensation is only available on Pandoras Box Servers
- for blacklevel compensation layers are needed that are not included in the first render pass, the composition pass (the render passes are explained in the topic [V5 Video Processing Pipeline](#)<sup>297</sup> )
- to exclude a layer from the composition pass, check the radio button "Output" in the [layer's Inspector](#)<sup>208</sup>
- this layer is now not affected by the output settings in regards to warp object, keystone and softedge settings
- use the layer with [effects](#)<sup>328</sup> that suit your need (area-coloring or black lifting colors), e.g [Gradient](#)<sup>423</sup> or [Shapes](#)<sup>527</sup> FX
- there are effects available, e.g. triangle and square gradients / shapes, to set up a geometry that matches exactly the shape needed. The different overlapping types are depicted in the above image. In addition, the shapes can be adjusted with different colors per corner. This is important when working with projectors that show a gradient due to lens errors or worn out lamps
- it is possible too, to adjust the backgrounds RGB values in the [camera](#)<sup>589</sup> and [output](#)<sup>597</sup> layer

### 5.4.14 SPARK

for WINDOWS XP (Microsoft .Net 2 Runtime must be installed)

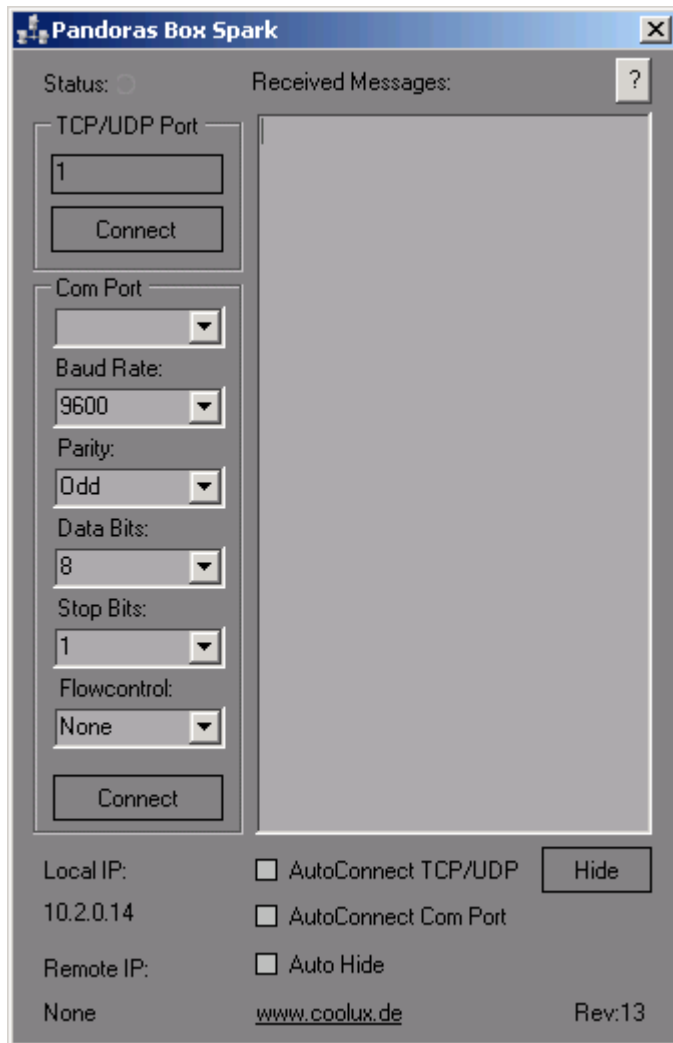

PB Spark is designed to be connected to any Pandoras Box timeline as a [Serial Link](#)<sup>729</sup> TCP IP device.

PB Spark can be used for remote controlling applications, mouse and keyboard actions as well as displaying full-screen video playback and web page presentations among many other useful remote control features.

Pandoras Box Spark is available from the coolux website as freeware download [www.coolux.de](http://www.coolux.de).

To get started, install PB Spark on the desired PC that you want to control (Spark can be accessed also on the same machine that runs Pandoras Box)

Important Notice: Please switch off any firewall on all connected systems before using this application!

#### PB SPARK SETUP

Launch PB Spark.

Since PB Spark acts as a TCP IP server that will wait for a Pandoras Box connection you will need to specify the TCP/IP port that Spark should use to listen to incoming commands.

Set the TCP/IP port (any number between 1 and 9999) you want to listen to in PB Spark.

To start the TCP/IP server click "connect", PB Spark will now wait for a connection to be established.

## PANDORAS BOX SETUP

Go to Pandoras Box Manager or Server/Player Standalone Software.

First add a Serial Link device from the Device Tab to the Device Control Tree.

Open the tree icon and click on the Serial Link Device to view its properties in the Inspector Tab.

Uncheck the check box "Use Serial Link Header" as this option is only for use with Serial Link devices.

Enter the IP address of the computer that PB Spark is running on as well as the Port number entered in PB Spark.

Click on "Apply IP and Port".

Tip: PB Spark displays its local IP address in the bottom left corner.

The red "!" in the device tree should disappear once the connection is established and the connection icon in PB SPARK should turn to green.

Now you may start implementing commands as keys in the timeline for the COM parameter.

Spark will give you the following TCP messages as feedback:

on success (SparkProc,"Original Message",Processed)

on fail (SparkProc,"Original Message",ProcessError)

on syntax error (SparkProc,"Original Message",SyntaxError)

## COMMAND LIST

The following commands are all in ASCII format and need to be put in parentheses ()

Remote control features offer by PB Spark:

[PB REMOTE SERVER CONTROL](#) <sup>615</sup>

[COMPORT ASCII COMMUNICATION](#) <sup>616</sup>

[SYSTEM COMMANDS](#) <sup>616</sup>

[WEB BROWSER \(Fullscreen\)](#) <sup>616</sup>

[SOUND COMMANDS](#) <sup>616</sup>

[VIDEO PLAYER \(Fullscreen\)](#) <sup>616</sup>

[APPLICATION COMMANDS](#) <sup>617</sup>

[KEYBOARD EVENTS](#) <sup>617</sup>

[MOUSE EVENTS](#) <sup>617</sup>

[DESKTOP FADE TO BLACK -BETA](#) <sup>618</sup>

[WAKE ON LAN](#) <sup>618</sup>

[PB AUTOMATION REMOTE CONTROL](#) <sup>618</sup>

## COMMAND DESCRIPTION

### PB REMOTE SERVER CONTROLS

compatible with Pandoras Box Menu Rev7 and later

(PBShutdownAll) - Shuts down All Pandoras Box Servers on the network

(PBRebootAll) - Reboots All Pandoras Box Servers on the network

(PBShutdown,IP Address) - Shutdown Pandoras Box Server by IP Address

(PBReboot,IP Address) - Reboot Pandoras Box Server by IP Address

(PBStartMaster,IP Address) - Start Pandoras Box Server / Master by IP Address

(PBStartClient,IP Address) - Start Pandoras Box Client by IP Address

(PBClose,IP Address) - Close Pandoras Box Server / Master or Client by IP Address

UDP Sender allows sending broadcast ASCII messages  
UDPSend,Port,Message

#### COMPORT ASCII COMMUNICATION

(Serial,Settings,"Portname","Baudrate","Parity","Databits","Stopbits","Flowcontrol")

ex: (Serial,Settings,Com12,9600,None,8,1,None)

Valid Parameters:

Portname: Com1 - Com 255

Baudrate: 110 / 300 / 1200 / 2400 / 4800 / 9600 / 19200 / 38400 / 57600 / 115200 / 230400 / 460800 / 921600

Parity: "Even" / "Odd" / "None" / "Mark" / "Space"

Databits: 5 / 6 / 7 / 8

Stopbits: 1 / 1.5 / 2

Flowcontrol: "None" / "Xon/Xoff"

(Serial,Connect,"Portname")

(Serial,Send,"Message")

(Serial,SendHex,"Message")

example: (Serial,SendHex,41 42 43)

This hex values should send ABC as hex

(Serial,Disconnect)

#### SYSTEM COMMANDS

(System,Logoff) - logoff current user

(System,Shutdown) - shut down the system

(System,Reboot) - reboot the system

#### WEB BROWSER (Fullscreen)

(Browser,Open) - starts web browser

(Browser,Go,www.coolux.de) - navigate in an open web browser to [www.coolux.de](http://www.coolux.de)

(Browser,Close)

#### SOUND COMMANDS

(Sound,Play,C:\myaudio.wav) - plays the file myaudio.wav located in C:\

(Sound,Volume,50) - sets system volume to 50%, valid range is 0 to 100%

(Sound,Mute,On) - disables the system sound output

(Sound,Mute,Off) - enables the system sound output

#### VIDEO PLAYER (Fullscreen)

(Video,Load,C:\myvideo.avi) - open & loads video player with myvideo.avi located in C:\ - to play video use (Video,Play)

(Video,Playfile,C:\myvideo.avi) - open & plays video player with myvideo.avi located in C:\

(Video,Play) - plays video from current position

(Video,Pause) - pause video at current position



(Video,Stop) - stop video show  
 (Video,Close) - close video player

## APPLICATION COMMANDS

(Application,Start,C:\notepad.exe) - starts C:\notepad.exe  
 (Application,StartFile,C:\notepad.exe,C:\mytext.txt) - starts notepad with mytext.txt  
 (Application,FileOpen,C:\myvideo.avi) - opens file with registered application, in this case windows media player  
 (Application,Stop,notepad.exe) - based on the process name in the windows taskmanager the specified process will be terminated

## KEYBOARD EVENTS

(Keycode,A) - will generate a keystroke for the letter "A"  
 Access special Keys:  
 use "~" to send "Enter"

The keys argument can specify any single key or any key combined with ALT, CTRL, or SHIFT (or any combination of those keys). Each key is represented by one or more characters, such as a for the character "a", or {ENTER} for the ENTER key.

To combine a key with SHIFT, precede the key code with + (plus sign).  
 To combine a key with CTRL, precede the key code with ^ (caret).  
 To combine a key with ALT, precede the key code with % (percent sign).

To specify repeating keys, use the form {key number}. You must put a space between key and number. For example, {LEFT 42} means "press the LEFT ARROW key 42 times"; {h 10} means "press 'h' 10 times."

The following table lists the codes that can be used to specify characters that are not displayed when you press the corresponding key (such as ENTER or TAB).

BACKSPACE {BACKSPACE} or {BS}, BREAK {BREAK}, CAPS LOCK {CAPSLOCK}, CLEAR {CLEAR}, DELETE {DELETE} or {DEL}, DOWN ARROW {DOWN}, END {END}, ENTER (numeric keypad) {ENTER}, ENTER ~, ESC {ESCAPE} or {ESC}, HELP {HELP}, HOME {HOME}, INS {INSERT}, LEFT ARROW {LEFT}, NUM LOCK {NUMLOCK}, PAGE DOWN {PGDN}, PAGE UP {PGUP}, RETURN {RETURN}, RIGHT ARROW {RIGHT}, SCROLL LOCK {SCROLLLOCK}, TAB {TAB}, UP ARROW {UP}, F1 through F15 {F1} through {F15}.

## MOUSE EVENTS

Screen coordinates are handled as percentage of primary screen  
 x coordinate is 0 to 100.00 left to right  
 y coordinate is 0 to 100.00 bottom to top

(Mouse,Move,x as Percent,y as Percent) will move the mouse to xy screen coordinate  
 (Mouse,LeftClick, x as Percent, y as Percent) will perform a left click at specific screen coordinate  
 (Mouse,RightClick,x as Percent, y as Percent) will perform a right click at specific screen coordinate  
 (Mouse,MiddleClick, x as Percent, y as Percent) will perform a mouse middle click at specific screen coordinate  
 (Mouse,LeftClick) will perform a left click at current screen coordinate  
 (Mouse,RightClick) will perform a right click at current screen coordinate  
 (Mouse,MiddleClick) will perform a mouse middle click at current screen coordinate

## DESKTOP FADE TO BLACK -BETA

(FadeToBlack,Out,1.5) fades out to black in 1.5 sec (timing may not be 100% accurate, based on systems performance)

(FadeToBlack,In,4.7) fades in from black in 4.7 sec (timing may not be 100% accurate, based on systems performance)

## WAKE ON LAN

(WakeOnLan,Macadress) - wakes up a target computer with its matching MacAdress  
Make sure the Ethernet Card accepts WakeOnLan with Magic Packet

## PB AUTOMATION REMOTE CONTROL

Please note:

The following commands are only valid for PB Spark Rev. 16 or higher!

Old syntax (up to Spark Rev. 12) is still valid (see [here](#)<sup>619</sup>).

(PBA,Connect,IP\_Address,Domain)

(PBA,Disconnect)

(PBA,DeviceSetParam,SiteID,DeviceID,ParamName,AbsoluteValue)

(PBA,DeviceSetParamRelative,SiteID,DeviceID,ParamName,RelativeValue)

(PBA,DeviceSetMedia,SiteID,DeviceID,FolderID,FileID)

(PBA,DeviceSetMesh,SiteID,DeviceID,FolderID,FileID)

(PBA,ActivateAll)

(PBA,ActivateSite,SiteID)

(PBA,ActivateDevice,SiteID,DeviceID)

(PBA,ActivateParam,SiteID,DeviceID,ParamName)

(PBA,ClearAllActive)

(PBA,ClearActiveSite,SiteID)

(PBA,ClearActiveDevice,SiteID,DeviceID)

(PBA,ClearActiveParam,SiteID,DeviceID,ParamName)

(PBA,ResetAll)

(PBA,ResetSite,SiteID)

(PBA,ResetDevice,SiteID,DeviceID)

(PBA,ResetParam,SiteID,DeviceID,Opacity)

(PBA,SeqSetTimecode,SeqID,Hours,Minutes,Seconds,Frames)

(PBA,SeqGotoCue,SeqID,CueID)

(PBA,SeqNextCue,SeqID)

(PBA,SeqLastCue,SeqID)

(PBA,SeqNextFrame,SeqID)

(PBA,SeqLastFrame,SeqID)

(PBA,SeqSetState,SeqID,State) - States: Play, Pause or Stop

(PBA,SeqStoreActive,SeqID)

(PBA,SeqStoreActiveToTime,SeqID,Hours,Minutes,Seconds,Frames)

(PBA,ResourceSetText,FolderID,FileID,Text)

(PBA,ResourceAdd,Path,SiteID,FolderID,FileID)

(PBA,ResourceSpreadAll)  
 (PBA,ResourceSpreadMedia,FolderID,FileID)  
 (PBA,ResourceSpreadMesh,FolderID,FileID)

(PBA,ResourceSetFrameBlending,FolderID,FileID,State) - State: True or False  
 (PBA,ResourceSetDeinterlacing,FolderID,FileID,State) - State: 1,2,3,4 - according to De-Interlace  
 Combobox in PB File Inspector  
 (PBA,ResourceSetAnisotropicFiltering,FolderID,FileID,State) - State: True or False  
 (PBA,ResourceSetUnderscan,FolderID,FileID,State) - State: True or False  
 (PBA,ResourceSetMpegColourSpace,FolderID,FileID,State) - State: True or False  
 (PBA,ResourceSetAlphaChannel,FolderID,FileID,State) - State: True or False

(PBA,ResourceRemoveInconsistent)  
 (PBA,ResourceRemoveMedia,FolderID,FileID)  
 (PBA,ResourceRemoveMesh,FolderID,FileID)

(PBA,ToggleFullScreen,SiteID)

OLD SYNTAX FOR PB AUTOMATION REMOTE CONTROL (up to Rev. 12):

(PBA,Connect, "IP\_Adress", "Domain")  
 (PBA,Disconnect)  
 (PBA,SetParam,"NodeID", "DeviceID", "ParamName", "Value")  
 (PBA,SetMedia,"NodeID", "DeviceID", "DMX\_Folder\_ID", "DMX\_File\_ID")  
 (PBA,SetMesh,"NodeID", "DeviceID", "DMX\_Folder\_ID", "DMX\_File\_ID")  
 (PBA,SetCue,"SeqID", "CUE\_ID")  
 (PBA,SetSeq,"SeqID", "Mode") - Mode "Play", "Pause", "Stop")  
 (PBA,SetTime,"SeqID", Hours, Minutes, Seconds, Frames)  
 (PBA,NextFrame,"SeqID")  
 (PBA,LastFrame,"SeqID")  
 (PBA,NextCue,"SeqID")  
 (PBA,LastCue,"SeqID")  
 (PBA,SeqLevel,"Value")

UDP COMMUNICATION -  
 Send messages to ports

(UDPSend,Port,Message)

PB Server V4 Control

---

(PBShutdownAll)  
(PBRebootAll)  
(PBShutdown,IP)  
(PBReboot,IP)  
(PBStartMaster,IP)  
(PBStartClient,IP)  
(PBClose,IP)

## CHANGELOG

### Rev 12

- HTTP Querystring listener built-in.  
This means you can use a webbrowser or link to send commands as well ex:  
[http://192.168.0.141/?\(Commandstring\)](http://192.168.0.141/?(Commandstring))
- Comport Input Support
- All Inputs TCP/UDP/HTTP/COM can send input messages asynchronously
- multiple commands can be send in one message

### Rev7

- UDP Send and Receive Support
- PB Server Network Controls, for application commands and system shutdown
- General Code Cleanup Rev6 - support for broken packets, AMX related fix
- Autoconnect as Start option
- TCP connection close optimization
- PB Spark will always send a null character upon null receive
- Revision ID shown GUI
- New Feature Comport Send Hex-codes

### v1.0.0.9

- PBAutomation v4 commands added

### v1.0.0.8

- New Feature Application Stop to terminate running programs and processes

### v1.0.0.7

- New Feature Remote PB Automation Support
- Help page display

### v1.0.0.6

- New Feature Fullscreen video player
- New Feature Com Port ASCII communication
- fixed pending Network Process on closing application

## 5.5 EXTERNAL CONTROL (DMX,MIDI,...)

Pandoras Box offers many ways to use various industry standard control protocols.

You may want to remote control lighting or sound or interact with media through contact closures or sensors.

With Pandoras Box Spark, even Windows PC applications can be controlled and triggered at the right cue of the show.

Currently supported protocols are:

TCP/IP, RS232/422, SMPTE, MIDI, MSC, Art-Net, MA-NET, DMX and CIP.

Please find in the following topics the detailed information regarding:

Input Protocols	Output Protocols
<a href="#">DMX Tables</a> <sup>623</sup>	
<a href="#">(Patch Sheets for all products)</a> <sup>623</sup>	
<a href="#">DMX Input</a> <sup>621</sup>	<a href="#">DMX Output</a> <sup>642</sup>
<a href="#">MIDI</a> <sup>637</sup>	
<a href="#">MSC (MIDI Show Control)</a> <sup>637</sup>	
<a href="#">Serial Link</a> <sup>640</sup>	<a href="#">Serial Link</a> <sup>643</sup>
<a href="#">SMPTE Input</a> <sup>640</sup>	<a href="#">SMPTE Output</a> <sup>644</sup>
	<a href="#">Spark</a> <sup>643</sup>
<a href="#">TCP / IP</a> <sup>641</sup>	<a href="#">TCP / IP</a> <sup>644</sup>
<a href="#">UDP - PB Automation and SDK</a> <sup>641</sup>	

### 5.5.1 INPUT PROTOCOLS

Pandoras Box aims to support a wide range of various input control sources.

Since Pandoras Box can be used in many different configurations and applications, you may choose from several available control protocols to remote control or interact with the system.

#### 5.5.1.1 DMX INPUT

DMX input can be used in many different ways with Pandoras Box products. Since the entire system is mainly network based, coolux is continuing to integrate all available network-protocols to allow interfacing with modern lighting systems.

DMX input is mainly designed to remote control individual sequences, layers and output settings of your Pandoras Box system via an external DMX device, e.g. a lighting desk.

If you, on the other hand, are interested in controlling DMX devices with Pandoras Box itself, please read the topic covering the [DMX Output](#) <sup>642</sup>.

For any DMX input the following settings need to be done.

##### 1 - Connection

Connect the master system to the remote system. In general only the master (Pandoras Box Manager, Server or Player) needs to be connected as it controls its clients. In other words, it is not necessary to connect the client with the remote device.

##### 2 - Patch

In case you like to remote control a sequence, select the according sequence in the [Project tab](#) <sup>248</sup> and open the [Patch tab](#) <sup>222</sup>. Enter the channel, subnet and universe. The patch must accord to the patch in

the remote device. Please load a fixture or see the [DMX tables](#)<sup>623</sup> for more information.

In case of remote controlling layers from the master itself, select the master in the [Device Tree tab](#)<sup>168</sup> and patch it.

In case of remote controlling layers from clients, drag the client from the [Asset tab](#)<sup>137</sup> or [Device Types tab](#)<sup>181</sup> into the Device Tree tab first. Select the client node and patch it.

### 3 - Configuration

Activate the DMX input in the [Configuration tab](#)<sup>139</sup> in the section [Remote Control Protocols](#)<sup>146</sup>. You can choose a dedicated network adapter.

As soon as data is sent to the master system, all patched layers or sequence parameters are remote controlled.

If you like to work with media files, i.e. assign it to a layer, it needs to have a so called File and Folder ID. This can be assigned in the [File Inspector](#)<sup>190</sup> as well as [Folder Inspector](#)<sup>198</sup>. Pandoras Box supports a CITP based thumbnail exchange.

### MA-Net

To interface with GrandMA lighting consoles, please enable the MA-Net in the [Configuration tab](#)<sup>139</sup>. Please note that MA-Net supports up to 64 DMX universes in MA-Net Series 1 and up to 256 DMX universes in MA-Net Series 2.

### Art-Net

As one of the most popular Ethernet protocols, Art-Net can be used to control multiple units with multiple DMX universes via a single Ethernet network.

To use Art-Net please connect your lighting system that is Art-Net enabled and make sure that both lighting control and Pandoras Box system are in the same IP address range.

The first Art-Net specification demands a 2.xxx.xxx.xxx IP address, the most common used subnet mask is 255.0.0.0 . Pandoras Box is still tied to this specification when working with DMX fixtures (i.e. sending Art-Net data). If you are working with [matrix patches](#)<sup>757</sup>, you may address a different IP range there. Since version 5.3 the IP address does not necessarily need to be in the 2.x.x.x range to be able to receive Art-Net.

To enable Art-Net within a Pandoras Box Master system, please activate the Art-Net Mode in the [Configuration tab](#)<sup>139</sup>.

### DMX Link In

DMX input via USB is supplied by the [DMX Link USB interface cable](#)<sup>735</sup>. To enable it, press the input button "DMX via USB" in the [Configuration tab](#)<sup>139</sup>.

Please be aware that a single USB DMX interface will allow you to control a maximum of 512 DMX channels on subnet 0 and universe 0.

### DMX Link 8

The DMX link 8 converts up to 10 DMX universes to Ethernet (Art-Net protocol). Backwards, 8 DMX universes can be converted from Art-Net to DMX.

Please see the [DMX Link 8 Device Manual](#)<sup>736</sup> for further information.

### Streaming ACN

In the Configuration tab, click the button "Run sACN" if you want to control Pandoras Box via Streaming ACN (sACN).

Please note that Streaming CAN does not use Universe 0, so do not patch below Universe 1.

### 5.5.1.1.1 DMX TABLES

All Pandoras Box Products are designed to be fully controlled via DMX or Art-Net from any DMX Lighting Controller. The general workflow how to work with DMX Input is described in the [previous chapter](#)<sup>621</sup>.

In this section you will find all necessary information about the individual DMX fixture libraries for Layers, Cameras, Outputs and Sequences.

Please note that there are different libraries for Server, Player and Manager Products.

[DMX Table PB Manager](#)<sup>623</sup>

[DMX Table Sequence Control](#)<sup>623</sup>

[DMX Table PB Server](#)<sup>624</sup>

[DMX Table PB Player](#)<sup>632</sup>

#### 5.5.1.1.1.1 DMX TABLE PB MANAGER

Pandoras Box Media Manager					
PB Audio Track (11 Ch)					
DMX Ch	Parameter		Values	Meaning	default
1	Folder	8 Bit	0	no Folder	0
			1..255	Folder 1..255	
2	Media	8 Bit	0	no Media	0
			1..255	File 1..255	
3	Video Control	8 Bit	0	Stop	192
			64	Play Once	
			128	Pause	
			192	Play Loop	
4	Volume	16 Bit	0	no Audio -96db	0
			32768	0db	
			46300	3dB	
6	Inpoint	16 Bit	0	File Beginning	0
			65535	End of File	
8	Outpoint	16 Bit	0	File Beginning	65535
			65535	End of File	
10	Pan	16 Bit	0	Left Ch only	32768
			32768	Center - L+R Ch	
			65535	Right Ch only	

#### 5.5.1.1.1.2 DMX TABLE SEQUENCE CONTROL

PB Sequence (5 Ch)					
DMX Ch	Parameter		Values	Meaning	default
1	Opacity	8 Bit	0	OFF	255
			1.254		
			255	ON	
2	Transport Control	8 Bit	0	Pause	0
			128	Play	
			255	Stop	
3	Cue	8 Bit	0	no Cue	0
			1..255	select Cue by Cue ID	
4	Frame	16 Bit	0	Set Nowpointer to Frame Pos	0
			65535		

### 5.5.1.1.3 DMX TABLE PB SERVER

Server Video Layer						
Lighting	Manager					
97 CH	53 CH					
		Parameter		Values	Meaning	default
1	1	Folder	8 Bit	0 1..255	no Folder Folder 1..255	0
2	2	Media	8 Bit	0 1..255	no Media File 1..255	0
3	3	Obj Folder	8 Bit	0 1..255	no Folder Folder 1..255	0
4	4	Obj Media	8 Bit	0 1..255	no Object File 1..255	0
5	5	Opacity	8 Bit	0..255		0
Playback						
6	6	Video Control	8 Bit	0 64 128 192	Stop Play Once Pause Play Loop	192
7	7	Speed	8 Bit	0..127 128 129..255	10% to 100% 1:1 Speed (100%) 100% to 500%	128
8	8	Inpoint	16 Bit	0 65535	File Beginning End of File	0
10	10	Outpoint	16 Bit	0 65535	File Beginning End of File	65535
Audio						
12	12	Volume	16 Bit			0
Position						
<b>Note:</b>		<b>The Display is always 16.000 units wide. The height is calculated by the aspect Ratio. A 4:3 Display is 16.000 units wide and 12.000 units high Resolution: 1 DMX Step = 0.008 units</b>				
14	14	X Pos	16 Bit	0 32768 65535	-256.000 units or 16 Screenwidth to the left Center +256.000 units or 16 Screenwidth to the right	32768
16	16	Y Pos	16 Bit	0 32768 65535	-256.000 units Center +256.000 units	32768
18	18	Z Pos	16 Bit	0 32768 65535	-256.000 units Center +256.000 units	32768
Rotation						
<b>Note</b>		<b>Resolution: 1 DMX Step = 0.033°</b>				
20	20	X Angle	16 Bit	0 32768 65535	-1080.00° 0° +1080.00°	32768
22	22	Y Angle	16 Bit	0 32768 65535	-1080.00° 0° +1080.00°	32768
24	24	Z Angle	16 Bit	0 32768 65535	-1080.00° 0° +1080.00°	32768
<b>Note</b>		<b>Mode Channel deside between Angle and Speed</b>				
26	26	X Rot Mode	8 Bit	0 1	Indexed Rot Cont Rot	0
27	27	Y Rot Mode	8 Bit	0 1	Indexed Rot Cont Rot	0
28	28	Z Rot Mode	8 Bit	0 1	Indexed Rot Cont Rot	0
<b>Note</b>		<b>Resolution: 1 DMX Step = 1 Rotation per hour</b>				
29	29	X Speed	16 Bit	0 32768 65535	Stop	32768
31	31	Y Speed	16 Bit	0 32768 65535	Stop	32768
33	33	Z Speed	16 Bit	0 32768 65535	Stop	32768



Server Video Layer						
Lighting	Manager					
97 CH	53 CH					
Scale						
	<b>Note</b>	<b>Resolution: 1 DMX Step = 0.001 Unit</b> <b>Scale 0.5 = half size</b> <b>Scale 2.0 = double size</b>				
35	35	X Scale	16 Bit	0	0.000	1000
					1000 1.000	
					65535 65.535	
37	37	Y Scale	16 Bit	0	0.000	1000
					1000 1.000	
					65535 65.535	
39	39	Z Scale	16 Bit	0	0.000	1000
					1000 1.000	
					65535 65.535	
Rotation Pivot						
	<b>Note:</b>	<b>The Display is always 16.000 units wide. The height is calculated by the aspect Ratio.</b> <b>A 4:3 Display is 16.000 units wide and 12.000 units high</b> <b>Resolution: 1 DMX Step = 0.008 units</b>				
	41	X Rot Pivot	16 Bit	0	-256.000 units or 16 Screenwidth to the left	32768
					32768 Center	
					65535 +256.000 units or 16 Screenwidth to the right	
	43	Y Rot Pivot	16 Bit	0	-256.000 units	32768
					32768 Center	
					65535 +256.000 units	
	45	Z Rot Pivot	16 Bit	0	-256.000 units	32768
					32768 Center	
					65535 +256.000 units	
Scale Pivot						
	<b>Note:</b>	<b>The Display is always 16.000 units wide. The height is calculated by the aspect Ratio.</b> <b>A 4:3 Display is 16.000 units wide and 12.000 units high</b> <b>Resolution: 1 DMX Step = 0.008 units</b>				
	47	X Scale Pivot	16 Bit	0	-256.000 units or 16 Screenwidth to the left	32768
					32768 Center	
					65535 +256.000 units or 16 Screenwidth to the right	
	49	Y Scale Pivot	16 Bit	0	-256.000 units	32768
					32768 Center	
					65535 +256.000 units	
	51	Z Scale Pivot	16 Bit	0	-256.000 units	32768
					32768 Center	
					65535 +256.000 units	
Blend Mode						
	<b>Note:</b>	<b>Details on Blend Mode see Helpfile</b>				
	53	Blend Mode	8 Bit	0	Normal	0
					1..255 Blend Mode	
Effekts						
	<b>Note:</b>	<b>All MultiFX have 9 16Bit Parameter Ch.. Not all Parameters are used for all FX</b> <b>For Detailed Information on each FX have a look at the Helpfile</b>				
	41	FX1 Selection	8 Bit	0	no FX	0
					1..255 FX Id	
	42	FX 1.1	16 Bit	0..65535	Parameter 1	32768
	44	FX 1.2	16 Bit	0..65535	Parameter 2	32768
	46	FX 1.3	16 Bit	0..65535	Parameter 3	32768
	48	FX 1.4	16 Bit	0..65535	Parameter 4	32768
	50	FX 1.5	16 Bit	0..65535	Parameter 5	32768
	52	FX 1.6	16 Bit	0..65535	Parameter 6	32768
	54	FX 1.7	16 Bit	0..65535	Parameter 7	32768
	56	FX 1.8	16 Bit	0..65535	Parameter 8	32768
	58	FX 1.9	16 Bit	0..65535	Parameter 9	32768
	60	FX2 Selection	8 Bit	0	no FX	0
					1..255 FX Id	
	61	FX 2.1	16 Bit	0..65535	Parameter 1	32768
	63	FX 2.2	16 Bit	0..65535	Parameter 2	32768
	65	FX 2.3	16 Bit	0..65535	Parameter 3	32768
	67	FX 2.4	16 Bit	0..65535	Parameter 4	32768
	69	FX 2.5	16 Bit	0..65535	Parameter 5	32768
	71	FX 2.6	16 Bit	0..65535	Parameter 6	32768
	73	FX 2.7	16 Bit	0..65535	Parameter 7	32768
	75	FX 2.8	16 Bit	0..65535	Parameter 8	32768
	77	FX 2.9	16 Bit	0..65535	Parameter 9	32768
	79	FX 3 Selection	8 Bit	0	no FX	0
					1..255 FX Id	
	80	FX 3.1	16 Bit	0..65535	Parameter 1	32768
	82	FX 3.2	16 Bit	0..65535	Parameter 2	32768
	84	FX 3.3	16 Bit	0..65535	Parameter 3	32768
	86	FX 3.4	16 Bit	0..65535	Parameter 4	32768
	88	FX 3.5	16 Bit	0..65535	Parameter 5	32768
	90	FX 3.6	16 Bit	0..65535	Parameter 6	32768
	92	FX 3.7	16 Bit	0..65535	Parameter 7	32768
	94	FX 3.8	16 Bit	0..65535	Parameter 8	32768
	96	FX 3.9	16 Bit	0..65535	Parameter 9	32768

Server Graphic Layer						
Lighting	Manager					
91 CH	46CH					
		Parameter		Values	Meaning	default
1	1	Folder	8 Bit	0 1..255	no Folder Folder 1..255	0
2	2	Media	8 Bit	0 1..255	no Media File 1..255	0
3	3	Obj Folder	8 Bit	0 1..255	no Folder Folder 1..255	0
4	4	Obj Media	8 Bit	0 1..255	no Object File 1..255	0
5	5	Opacity	8 Bit	0..255		0
6	6	Frame	16 Bit	0 65535	1st Frame Last Frame	0
<b>Position</b>						
<b>Note:</b>		<b>The Display is always 16.000 units wide. The height is calculated by the aspect Ratio. A 4:3 Display is 16.000 units wide and 12.000 units high Resolution: 1 DMX Step = 0.008 units</b>				
8	8	X Pos	16 Bit	0 32768 65535	-256.000 units or 16 Screenwidth to the left Center +256.000 units or 16 Screenwidth to the right	32768
10	10	Y Pos	16 Bit	0 32768 65535	-256.000 units Center +256.000 units	32768
12	12	Z Pos	16 Bit	0 32768 65535	-256.000 units Center +256.000 units	32768
<b>Rotation</b>						
<b>Note</b>		<b>Resolution: 1 DMX Step = 0.033°</b>				
14	14	X Angle	16 Bit	0 32768 65535	-1080.00° 0° +1080.00°	32768
16	16	Y Angle	16 Bit	0 32768 65535	-1080.00° 0° +1080.00°	32768
18	18	Z Angle	16 Bit	0 32768 65535	-1080.00° 0° +1080.00°	32768
<b>Note</b>		<b>Mode Channel deside between Angle and Speed</b>				
20	20	X Rot Mode	8 Bit	0 1	Indexed Rot Cont Rot	0
21	21	Y Rot Mode	8 Bit	0 1	Indexed Rot Cont Rot	0
22	22	Z Rot Mode	8 Bit	0 1	Indexed Rot Cont Rot	0
<b>Note</b>		<b>Resolution: 1 DMX Step = 1 Rotation per hour</b>				
23	23	X Speed	16 Bit	0 32768 65535	Stop	32768
25	25	Y Speed	16 Bit	0 32768 65535	Stop	32768
27	27	Z Speed	16 Bit	0 32768 65535	Stop	32768

Server Graphic Layer						
Lighting	Manager					
91 CH	46CH					
Scale						
	<b>Note:</b>	<b>Resolution: 1 DMX Step = 0.001 Unit</b>				
		<b>Scale 0.5 = half size</b>				
		<b>Scale 2.0 = double size</b>				
29	29	X Scale	16 Bit	0 0.000		1000
				1000 1.000		
				65535 65.535		
31	31	Y Scale	16 Bit	0 0.000		1000
				1000 1.000		
				65535 65.535		
33	33	Z Scale	16 Bit	0 0.000		1000
				1000 1.000		
				65535 65.535		
Rotation Pivot						
	<b>Note:</b>	<b>The Display is always 16.000 units wide. The height is calculated by the aspect Ratio.</b>				
		<b>A 4:3 Display is 16.000 units wide and 12.000 units high</b>				
		<b>Resolution: 1 DMX Step = 0.008 units</b>				
	35	X Rot Pivot	16 Bit	0	-256.000 units or 16 Screenwidth to the left	32768
				32768	Center	
				65535	+256.000 units or 16 Screenwidth to the right	
	37	Y Rot Pivot	16 Bit	0	-256.000 units	32768
				32768	Center	
				65535	+256.000 units	
	39	Z Rot Pivot	16 Bit	0	-256.000 units	32768
				32768	Center	
				65535	+256.000 units	
Scale Pivot						
	<b>Note:</b>	<b>The Display is always 16.000 units wide. The height is calculated by the aspect Ratio.</b>				
		<b>A 4:3 Display is 16.000 units wide and 12.000 units high</b>				
		<b>Resolution: 1 DMX Step = 0.008 units</b>				
	41	X Scale Pivot	16 Bit	0	-256.000 units or 16 Screenwidth to the left	32768
				32768	Center	
				65535	+250.000 units or 16 Screenwidth to the right	
	43	Y Scale Pivot	16 Bit	0	-256.000 units	32768
				32768	Center	
				65535	+256.000 units	
	45	Z Scale Pivot	16 Bit	0	-256.000 units	32768
				32768	Center	
				65535	+256.000 units	
Effekts						
	<b>Note:</b>	<b>All MultiFX have 9 16Bit Parameter Ch.. Not all Parameters are used for all FX</b>				
		<b>For Detailed Information on each FX have a look at the Helpfile</b>				
35		FX1 Selection	8 Bit		0 no FX	0
				1..255	FX Id	
36		FX 1.1	16 Bit	0..65535	Parameter 1	32768
38		FX 1.2	16 Bit	0..65535	Parameter 2	32768
40		FX 1.3	16 Bit	0..65535	Parameter 3	32768
42		FX 1.4	16 Bit	0..65535	Parameter 4	32768
44		FX 1.5	16 Bit	0..65535	Parameter 5	32768
46		FX 1.6	16 Bit	0..65535	Parameter 6	32768
48		FX 1.7	16 Bit	0..65535	Parameter 7	32768
50		FX 1.8	16 Bit	0..65535	Parameter 8	32768
52		FX 1.9	16 Bit	0..65535	Parameter 9	32768
54		FX2 Selection	8 Bit		0 no FX	0
				1..255	FX Id	
55		FX 2.1	16 Bit	0..65535	Parameter 1	32768
57		FX 2.2	16 Bit	0..65535	Parameter 2	32768
59		FX 2.3	16 Bit	0..65535	Parameter 3	32768
61		FX 2.4	16 Bit	0..65535	Parameter 4	32768
63		FX 2.5	16 Bit	0..65535	Parameter 5	32768
65		FX 2.6	16 Bit	0..65535	Parameter 6	32768
67		FX 2.7	16 Bit	0..65535	Parameter 7	32768
69		FX 2.8	16 Bit	0..65535	Parameter 8	32768
71		FX 2.9	16 Bit	0..65535	Parameter 9	32768
73		FX 3 Selection	8 Bit		0 no FX	0
				1..255	FX Id	
74		FX 3.1	16 Bit	0..65535	Parameter 1	32768
76		FX 3.2	16 Bit	0..65535	Parameter 2	32768
78		FX 3.3	16 Bit	0..65535	Parameter 3	32768
80		FX 3.4	16 Bit	0..65535	Parameter 4	32768
82		FX 3.5	16 Bit	0..65535	Parameter 5	32768
84		FX 3.6	16 Bit	0..65535	Parameter 6	32768
86		FX 3.7	16 Bit	0..65535	Parameter 7	32768
88		FX 3.8	16 Bit	0..65535	Parameter 8	32768
90		FX 3.9	16 Bit	0..65535	Parameter 9	32768

Server Camera Device							
Lighting	Manager						
23 CH	27 CH						
		Parameter		Values	Meaning		default
1	1	Mode	8 Bit	0	Perspective		0
				1	Orthogonal		
<b>Viewpoint Position</b>							
		<b>Note:</b>		<b>Z Pos needs to be at -25.000 as Default!</b>			
				<b>The Display is always 16.000 units wide. The height is calculated by the aspect Ratio.</b>			
				<b>A 4:3 Display is 16.000 units wide and 12.000 units high</b>			
				<b>Resolution: 1 DMX Step = 0.008 units</b>			
2	2	X Pos	16 Bit	0	-256.000 units or 16 Screenwidth to the left		32768
				32768	Center		
				65535	+256.000 units or 16 Screenwidth to the right		
4	4	Y Pos	16 Bit	0	-256.000 units		32768
				32768	Center		
				65535	+256.000 units		
6	6	Z Pos	16 Bit	0	-256.000 units		29568
				32768	Center		
				65535	+256.000 units		
<b>Target Position</b>							
		<b>Note:</b>		<b>The Display is always 16.000 units wide. The height is calculated by the aspect Ratio.</b>			
				<b>A 4:3 Display is 16.000 units wide and 12.000 units high</b>			
				<b>Resolution: 1 DMX Step = 0.008 units</b>			
8	8	Traget XPos	16 Bit	0	-256.000 units or 16 Screenwidth to the left		32768
				32768	Center		
				65535	+256.000 units or 16 Screenwidth to the right		
10	10	Target Y Pos	16 Bit	0	-256.000 units		32768
				32768	Center		
				65535	+256.000 units		
12	12	Target Z Pos	16 Bit	0	-256.000 units		32768
				32768	Center		
				65535	+256.000 units		
<b>Settings</b>							
14	14	FOV	16 Bit	0		0.001	17745
						35.489	
						131.070	
	16	Near Plane	16 Bit	0..65535			5
	18	Far Plane	16 Bit	0..65535			50000
16	20	Aspect Ratio	16 Bit	0		0.000	10924
						1.000	
						3.000	
						6.000	
<b>Lens Shift</b>							
18	22	X Offset	16 Bit	0	-256.000 units		32768
				32768	Center		
				65535	+256.000 units		
20	24	Y Offset	16 Bit	0	-256.000 units		32768
				32768	Center		
				65535	+256.000 units		
22	26	Z Roll	16 Bit	0	-1080.00°		32768
				32768	0°		
				65535	+1080.00°		

Server Output						
Lighting	Manager					
124 CH	113 CH					
DMX Ch		Parameter		Values	Meaning	default
1	1	Bypass	8 Bit	0 1..255		0
Object						
2	2	Obj Folder	8 Bit	0 1..255	no Folder Folder 1..255	0
3	3	Obj Media	8 Bit	0 1..255	no Object File 1..255	0
4	4	Opacity	8 Bit	0..255		255
Position						
<b>Note:</b>		<b>The Display is always 16.000 units wide. The height is calculated by the aspect Ratio. A 4:3 Display is 16.000 units wide and 12.000 units high Resolution: 1 DMX Step = 0.008 units</b>				
5	5	X Pos	16 Bit	0 32768 65535	-256.000 units or 16 Screenwidth to the left Center +256.000 units or 16 Screenwidth to the right	32768
7	7	Y Pos	16 Bit	0 32768 65535	-256.000 units Center +256.000 units	32768
9	9	Z Pos	16 Bit	0 32768 65535	-256.000 units Center +256.000 units	32768
Rotation						
<b>Note</b>		<b>Resolution: 1 DMX Step = 0.033°</b>				
11	11	X Angle	16 Bit	0 32768 65535	-1080.00° 0° +1080.00°	32768
13	13	Y Angle	16 Bit	0 32768 65535	-1080.00° 0° +1080.00°	32768
15	15	Z Angle	16 Bit	0 32768 65535	-1080.00° 0° +1080.00°	32768
<b>Note</b>		<b>Mode Channel deside between</b>				
17	17	X Rot Mode	8 Bit	0 1	Indexed Rot Cont Rot	0
18	18	Y Rot Mode	8 Bit	0 1	Indexed Rot Cont Rot	0
19	19	Z Rot Mode	8 Bit	0 1	Indexed Rot Cont Rot	0
<b>Note</b>		<b>Resolution: 1 DMX Step = 1 Rotation per hour</b>				
20	20	X Speed	16 Bit	0 32768 65535	Stop	32768
22	22	Y Speed	16 Bit	0 32768 65535	Stop	32768
24	24	Z Speed	16 Bit	0 32768 65535	Stop	32768
Scale						
<b>Note</b>		<b>Resolution: 1 DMX Step = 0.001 Unit Scale 0.5 = half size Scale 2.0 = double size</b>				
26	26	X Scale	16 Bit	0 0.000 1000 1.000 65535 65.535		1000
28	28	Y Scale	16 Bit	0 0.000 1000 1.000 65535 65.535		1000
30	30	Z Scale	16 Bit	0 0.000 1000 1.000 65535 65.535		1000

Server Output						
Lighting	Manager					
124 CH	113 CH					
Rotation Pivot						
<b>Note:</b> <i>The Display is always 16.000 units wide. The height is calculated by the aspect Ratio.</i>						
<i>A 4:3 Display is 16.000 units wide and 12.000 units high</i>						
<i>Resolution: 1 DMX Step = 0.008 units</i>						
32	X Rot Pivot	16 Bit	0	-256.000 units or 16 Screenwidth to the left		32768
			32768	Center		
			65535	+256.000 units or 16 Screenwidth to the right		
34	Y Rot Pivot	16 Bit	0	-256.000 units		32768
			32768	Center		
			65535	+256.000 units		
36	Z Rot Pivot	16 Bit	0	-256.000 units		32768
			32768	Center		
			65535	+256.000 units		
Scale Pivot						
<b>Note:</b> <i>The Display is always 16.000 units wide. The height is calculated by the aspect Ratio.</i>						
<i>A 4:3 Display is 16.000 units wide and 12.000 units high</i>						
<i>Resolution: 1 DMX Step = 0.008 units</i>						
38	X Scale Pivot	16 Bit	0	-256.000 units or 16 Screenwidth to the left		32768
			32768	Center		
			65535	+250.000 units or 16 Screenwidth to the right		
40	Y Scale Pivot	16 Bit	0	-256.000 units		32768
			32768	Center		
			65535	+256.000 units		
42	Z Scale Pivot	16 Bit	0	-256.000 units		32768
			32768	Center		
			65535	+256.000 units		
Viewpoint Position						
<b>Note:</b> <i>Z Pos needs to be at -25.000 as Default!</i>						
<i>The Display is always 16.000 units wide. The height is calculated by the aspect Ratio.</i>						
<i>A 4:3 Display is 16.000 units wide and 12.000 units high</i>						
<i>Resolution: 1 DMX Step = 0.008 units</i>						
44	X Pos	16 Bit	0	-256.000 units or 16 Screenwidth to the left		32768
			32768	Center		
			65535	+256.000 units or 16 Screenwidth to the right		
46	Y Pos	16 Bit	0	-256.000 units		32768
			32768	Center		
			65535	+256.000 units		
48	Z Pos	16 Bit	0	-256.000 units		29568
			32768	Center		
			65535	+256.000 units		
Target Position						
<b>Note:</b> <i>The Display is always 16.000 units wide. The height is calculated by the aspect Ratio.</i>						
<i>A 4:3 Display is 16.000 units wide and 12.000 units high</i>						
<i>Resolution: 1 DMX Step = 0.008 units</i>						
50	Traget X Pos	16 Bit	0	-256.000 units or 16 Screenwidth to the left		32768
			32768	Center		
			65535	+256.000 units or 16 Screenwidth to the right		
52	Target Y Pos	16 Bit	0	-256.000 units		32768
			32768	Center		
			65535	+256.000 units		
54	Target Z Pos	16 Bit	0	-256.000 units		32768
			32768	Center		
			65535	+256.000 units		
Settings						
56	FOV	16 Bit	0		0.001	17745
			17745		35.489	
			65535		131.070	
58	Near Plane	16 Bit	0..65535			5
60	Far Plane	16 Bit	0..65535			50000
62	Aspect Ratio	16 Bit	0		0.000	10924
			10924		1.000	
			32768		3.000	
			65535		6.000	
Lens Shift						
64	X Offset	16 Bit	0	-256.000 units		32768
			32768	Center		
			65535	+256.000 units		
66	Y Offset	16 Bit	0	-256.000 units		32768
			32768	Center		
			65535	+256.000 units		
68	Z Roll	16 Bit	0	-1080.00°		32768
			32768	0°		
			65535	+1080.00°		

Server Output						
Lighting	Manager					
124 CH	113 CH					
<b>Keystone</b>						
32	70	Keystone L	16 Bit	0..65535		32768
34	72	Keystone L Pos	16 Bit	0..65535		32768
36	74	Keystone R	16 Bit	0..65535		32768
38	76	Keystone R Pos	16 Bit	0..65535		32768
40	78	Keystone T	16 Bit	0..65535		32768
42	80	Keystone T Pos	16 Bit	0..65535		32768
44	82	Keystone B	16 Bit	0..65535		32768
46	84	Keystone B Pos	16 Bit	0..65535		32768
48	86	Linearity X	16 Bit	0..65535		32768
50	88	Linearity Y	16 Bit	0..65535		32768
<b>Softedge</b>						
52	90	Softedge Left	16 Bit	0..65535		0
54	92	Softedge Left Curve	16 Bit	0..65535		32768
	94	Softedge Left Marker	8 Bit	0	no marker	0
				1..255	black to white marker	
	95	Softedge Left Maker Width	8 Bit	0..255		32
56	96	Softedge Right	16 Bit	0..65535		0
58	98	Softedge Right Curve	16 Bit	0..65535		32768
	100	Softedge Right Marker	8 Bit	0	no marker	0
				1..255	black to white marker	
	101	Softedge Right Maker Width	8 Bit	0..255		32
60	102	Softedge Top	16 Bit	0..65535		0
62	104	Softedge Top Curve	16 Bit	0..65535		32768
	106	Softedge Top Marker	8 Bit	0	no marker	0
				1..255	black to white marker	
	107	Softedge Left Top Width	8 Bit	0..255		32
64	108	Softedge Bottom	16 Bit	0..65535		0
66	110	Softedge Bottom Curve	16 Bit	0..65535		32768
	112	Softedge Bottom Marker	8 Bit	0	no marker	0
				1..255	black to white marker	
	113	Softedge Bottom Maker Width	8 Bit	0..255		32
<b>Effekts</b>						
	<b>Note:</b>	<b>All MultiFX have 9 16Bit Parameter Ch.. Not all Parameters are used for all FX</b>				
		<b>For Detailed Information on each FX have a look at the Helpfile</b>				
68		FX1 Selection	8 Bit	0	no FX	0
				1..255	FX Id	
69		FX 1.1	16 Bit	0..65535	Parameter 1	32768
71		FX 1.2	16 Bit	0..65535	Parameter 2	32768
73		FX 1.3	16 Bit	0..65535	Parameter 3	32768
75		FX 1.4	16 Bit	0..65535	Parameter 4	32768
77		FX 1.5	16 Bit	0..65535	Parameter 5	32768
79		FX 1.6	16 Bit	0..65535	Parameter 6	32768
81		FX 1.7	16 Bit	0..65535	Parameter 7	32768
83		FX 1.8	16 Bit	0..65535	Parameter 8	32768
85		FX 1.9	16 Bit	0..65535	Parameter 9	32768
87		FX2 Selection	8 Bit	0	no FX	0
				1..255	FX Id	
88		FX 2.1	16 Bit	0..65535	Parameter 1	32768
90		FX 2.2	16 Bit	0..65535	Parameter 2	32768
92		FX 2.3	16 Bit	0..65535	Parameter 3	32768
94		FX 2.4	16 Bit	0..65535	Parameter 4	32768
96		FX 2.5	16 Bit	0..65535	Parameter 5	32768
98		FX 2.6	16 Bit	0..65535	Parameter 6	32768
100		FX 2.7	16 Bit	0..65535	Parameter 7	32768
102		FX 2.8	16 Bit	0..65535	Parameter 8	32768
104		FX 2.9	16 Bit	0..65535	Parameter 9	32768
106		FX 3 Selection	8 Bit	0	no FX	0
				1..255	FX Id	
107		FX 3.1	16 Bit	0..65535	Parameter 1	32768
109		FX 3.2	16 Bit	0..65535	Parameter 2	32768
111		FX 3.3	16 Bit	0..65535	Parameter 3	32768
113		FX 3.4	16 Bit	0..65535	Parameter 4	32768
115		FX 3.5	16 Bit	0..65535	Parameter 5	32768
117		FX 3.6	16 Bit	0..65535	Parameter 6	32768
119		FX 3.7	16 Bit	0..65535	Parameter 7	32768
121		FX 3.8	16 Bit	0..65535	Parameter 8	32768
123		FX 3.9	16 Bit	0..65535	Parameter 9	32768

### 5.5.1.1.4 DMX TABLE PB PLAYER

<b>Note:</b> DUAL and QUAD Players have the same Patch as Player PRO										
<b>Player Video Layer</b>										
<b>Player Pro</b>		<b>Player STD</b>		<b>Player LT</b>						
Lighting	Manager	Lighting	Manager	Lighting	Manager					
62 CH	34 CH	44 CH	34 CH	26 CH	34 CH					
						Parameter	Values	Meaning	default	
1	1	1	1	1	1	Folder	8 Bit 0 1..255	no Folder Folder 1..255		0
2	2	2	2	2	2	Media	8 Bit 0 1..255	no Media File 1..255		0
3	3	3	3	3	3	Obj Folder	8 Bit 0 1..255	no Folder Folder 1..255		0
4	4	4	4	4	4	Obj Media	8 Bit 0 1..255	no Object File 1..255		0
5	5	5	5	5	5	Opacity	8 Bit 0..255			0
<b>Playback</b>										
6	6	6	6	6	6	Video Control	8 Bit 0 64 128 192	Stop Play Once Pause Play Loop		192
7	7	7	7	7	7	Speed	8 Bit 0..127 128 129..255	slower 1:1 Speed faster		128
8	8	8	8	8	8	Inpoint	16 Bit 0 65535	File Beginning End of File		0
10	10	10	10	10	10	Outpoint	16 Bit 0 65535	File Beginning End of File		65535
<b>Audio</b>										
12	12	12	12	12	12	Volume	16 Bit			0
<b>Position</b>										
<b>Note:</b> The Display is always 16.000 units wide. The height is calculated by the aspect Ratio. A 4:3 Display is 16.000 units wide and 12.000 units high Resolution: 1 DMX Step = 0.008 units										
14	14	14	14	14	14	X Pos	16 Bit 0 32768 65535	-256.000 units or 16 Screenwidth to the left Center +250.000 units or 16 Screenwidth to the right		32768
16	16	16	16	16	16	Y Pos	16 Bit 0 32768 65535	-256.000 units Center +256.000 units		32768
<b>Rotation</b>										
<b>Note</b> Angle Resolution: 1 DMX Step = 0.033° Speed Resolution: 1 DMX Step = 1 Rotation per hour										
18	18	18	18	18	18	Z Angle	16 Bit 0 32768 65535	-1080.00° 0° +1080.00°		32768
20	20	20	20	20	20	Z Mode	8 Bit 0 1	Indexed Rot Cont Rot		0
21	21	21	21	21	21	Z Speed	16 Bit 0 32768 65535	Stop		32768
<b>Scale</b>										
<b>Note</b> Resolution: 1 DMX Step = 0.001 Unit Scale 0.5 = half size Scale 2.0 = double size										
23	23	23	23	23	23	X Scale	16 Bit 0 1000 65535	0.000 1.000 65.535		1000
25	25	25	25	25	25	Y Scale	16 Bit 0 1000 65535	0.000 1.000 65.535		1000



Player Video Layer										
Player Pro		Player STD		Player LT						
Lighting	Manager	Lighting	Manager	Lighting	Manager					
62 CH	34 CH	44 CH	34 CH	26 CH	34 CH					
Rotation Pivot										
<b>Note:</b> <i>The Display is always 16.000 units wide. The height is calculated by the aspect Ratio.</i>										
<i>A 4:3 Display is 16.000 units wide and 12.000 units high</i>										
<i>Resolution: 1 DMX Step = 0.008 units</i>										
	27		27		27	X Rot Pivot	16 Bit	0	-256.000 units or 16 Screenwidth to the left	32768
								32768	Center	
								65535	+256.000 units or 16 Screenwidth to the right	
	29		29		29	Y Rot Pivot	16 Bit	0	-256.000 units	32768
								32768	Center	
								65535	+256.000 units	
Scale Pivot										
<b>Note:</b> <i>The Display is always 16.000 units wide. The height is calculated by the aspect Ratio.</i>										
<i>A 4:3 Display is 16.000 units wide and 12.000 units high</i>										
<i>Resolution: 1 DMX Step = 0.008 units</i>										
	31		31		31	X Scale Pivot	16 Bit	0	-256.000 units or 16 Screenwidth to the left	32768
								32768	Center	
								65535	+256.000 units or 16 Screenwidth to the right	
	33		33		33	Y Scale Pivot	16 Bit	0	-256.000 units	32768
								32768	Center	
								65535	+256.000 units	
Effekts										
<b>Note:</b> <i>All Player MultiFX have 4 16Bit Parameter Ch.. Not all Parameters are used for all FX</i>										
<i>For Detailed Information on each FX have a look at the Helpfile</i>										
27		27				FX1 Selection	8 Bit	0	no FX	0
								1..255	FX Id	
28		28				FX 1.1	16 Bit	0..65535	Parameter 1	32768
30		30				FX 1.2	16 Bit	0..65535	Parameter 2	32768
32		32				FX 1.3	16 Bit	0..65535	Parameter 3	32768
34		34				FX 1.4	16 Bit	0..65535	Parameter 4	32768
36		36				FX2 Selection	8 Bit	0	no FX	0
								1..255	FX Id	
37		37				FX 2.1	16 Bit	0..65535	Parameter 1	32768
39		39				FX 2.2	16 Bit	0..65535	Parameter 2	32768
41		41				FX 2.3	16 Bit	0..65535	Parameter 3	32768
43		43				FX 2.4	16 Bit	0..65535	Parameter 4	32768
45						FX3 Selection	8 Bit	0	no FX	0
								1..255	FX Id	
46						FX 3.1	16 Bit	0..65535	Parameter 1	32768
48						FX 3.2	16 Bit	0..65535	Parameter 2	32768
50						FX 3.3	16 Bit	0..65535	Parameter 3	32768
52						FX 3.4	16 Bit	0..65535	Parameter 4	32768
54						FX4 Selection	8 Bit	0	no FX	0
								1..255	FX Id	
55						FX 4.1	16 Bit	0..65535	Parameter 1	32768
57						FX 4.2	16 Bit	0..65535	Parameter 2	32768
59						FX 4.3	16 Bit	0..65535	Parameter 3	32768
61						FX 4.4	16 Bit	0..65535	Parameter 4	32768

Player Grafik Layer										
Player Pro		Player STD		Player LT						
Lighting	Manager	Lighting	Manager	Lighting	Manager					
56 CH	28 CH	38 CH	28 CH	20 CH	28 CH					
						Parameter	Values	Meaning	default	
1	1	1	1	1	1	Folder	8 Bit	0 1..255	no Folder Folder 1..255	0
2	2	2	2	2	2	Media	8 Bit	0 1..255	no Media File 1..255	0
3	3	3	3	3	3	Obj Folder	8 Bit	0 1..255	no Folder Folder 1..255	0
4	4	4	4	4	4	Obj Media	8 Bit	0 1..255	no Object File 1..255	0
5	5	5	5	5	5	Opacity	8 Bit	0..255		0
6	6	6	6	6	6	Frame	16 Bit	0 65535	1st Frame Last Frame	0
Position										
<b>Note:</b> The Display is always 16.000 units wide. The height is calculated by the aspect Ratio. A 4:3 Display is 16.000 units wide and 12.000 units high Resolution: 1 DMX Step = 0.008 units										
8	8	8	8	8	8	X Pos	16 Bit	0 32768 65535	-256.000 units or 16 Screenwidth to the left Center +250.000 units or 16 Screenwidth to the right	32768
10	10	10	10	10	10	Y Pos	16 Bit	0 32768 65535	-256.000 units Center +256.000 units	32768
Rotation										
<b>Note</b> Resolution: 1 DMX Step = 0.033°										
12	12	12	12	12	12	Z Rot	16 Bit	0 32768 65535	-1080.00° 0° +1080.00°	32768
14	14	14	14	14	14	Z Mode	8 Bit	0 1	Indexed Rot Cont Rot	0
15	15	15	15	15	15	Z Speed	16 Bit	0 32768 65535	Stop	32768
Scale										
<b>Note</b> Resolution: 1 DMX Step = 0.001 Unit Scale 0.5 = half size Scale 2.0 = double size										
17	17	17	17	17	17	X Scale	16 Bit	0 1000 65535	0.000 1.000 65.535	1000
19	19	19	19	19	19	Y Scale	16 Bit	0 1000 65535	0.000 1.000 65.535	1000

Player Grafik Layer										
Player Pro		Player STD		Player LT						
Lighting	Manager	Lighting	Manager	Lighting	Manager					
56 CH	28 CH	38 CH	28 CH	20 CH	28 CH					
<b>Rotation Pivot</b>										
<b>Note:</b> The Display is always 16.000 units wide. The height is calculated by the aspect Ratio. A 4:3 Display is 16.000 units wide and 12.000 units high Resolution: 1 DMX Step = 0.008 units										
	21		21		21	X Rot Pivot	16 Bit	0 32768 65535	-256.000 units or 16 Screenwidth to the left Center +256.000 units or 16 Screenwidth to the right	32768
	23		23		23	Y Rot Pivot	16 Bit	0 32768 65535	-256.000 units Center +256.000 units	32768
<b>Scale Pivot</b>										
<b>Note:</b> The Display is always 16.000 units wide. The height is calculated by the aspect Ratio. A 4:3 Display is 16.000 units wide and 12.000 units high Resolution: 1 DMX Step = 0.008 units										
	25		25		25	X Scale Pivot	16 Bit	0 32768 65535	-256.000 units or 16 Screenwidth to the left Center +256.000 units or 16 Screenwidth to the right	32768
	27		27		27	Y Scale Pivot	16 Bit	0 32768 65535	-256.000 units Center +256.000 units	32768
<b>Effekts</b>										
<b>Note:</b> All Player MultiFX have 4 16Bit Parameter Ch.. Not all Parameters are used for all FX For Detailed Information on each FX have a look at the Helpfile										
21		21				FX1 Selection	8 Bit	0 1..255	no FX FX Id	0
22		22				FX 1.1	16 Bit	0..65535	Parameter 1	32768
24		24				FX 1.2	16 Bit	0..65535	Parameter 2	32768
26		26				FX 1.3	16 Bit	0..65535	Parameter 3	32768
28		28				FX 1.4	16 Bit	0..65535	Parameter 4	32768
30		30				FX2 Selection	8 Bit	0 1..255	no FX FX Id	0
31		31				FX 2.1	16 Bit	0..65535	Parameter 1	32768
33		33				FX 2.2	16 Bit	0..65535	Parameter 2	32768
35		35				FX 2.3	16 Bit	0..65535	Parameter 3	32768
37		37				FX 2.4	16 Bit	0..65535	Parameter 4	32768
39						FX3 Selection	8 Bit	0 1..255	no FX FX Id	0
40						FX 3.1	16 Bit	0..65535	Parameter 1	32768
42						FX 3.2	16 Bit	0..65535	Parameter 2	32768
44						FX 3.3	16 Bit	0..65535	Parameter 3	32768
46						FX 3.4	16 Bit	0..65535	Parameter 4	32768
48						FX4 Selection	8 Bit	0 1..255	no FX FX Id	0
49						FX 4.1	16 Bit	0..65535	Parameter 1	32768
51						FX 4.2	16 Bit	0..65535	Parameter 2	32768
53						FX 4.3	16 Bit	0..65535	Parameter 3	32768
55						FX 4.4	16 Bit	0..65535	Parameter 4	32768

<b>Note:</b> DUAL and QUAD Players have the same Patch as Player PRO										
Player Camera Device										
Player Pro		Player STD		Player LT						
Lighting	Manager	Lighting	Manager	Lighting	Manager					
7 CH	7 CH	7 CH	7 CH	7 CH	7 CH					
	1		1		1	Parameter		Values	Meaning	default
						Mode	8 Bit	0 1	Perspective Orthogonal	0
<b>Lens Shift</b>										
<b>Note:</b> This is the Offset that you use to arrange the Cameras for a Softedge Setup										
	2		2		2	X Offset	16 Bit	0 32768 65535	-256.000 units Center +256.000 units	32768
	4		4		4	Y Offset	16 Bit	0 32768 65535	-256.000 units Center +256.000 units	32768
	6		6		6	Z Roll	16 Bit	0 32768 65535	-1080.00° 0° +1080.00°	32768



### 5.5.1.2 MIDI

The Midi Input protocol supports the following message types:

Channel Voice Messages

All Note-On messages are processed.

#### PRESET CONTROL

The channel is mapped to the Pandoras Box preset tree. Channel 1 = GLOBAL ... Channel 9 = CTRL

The note calls the equivalent preset. The notes are being processed with a negative offset of 35 to assign the value 1 to the lowest note of a standard midi keyboard

#### SEQUENCE CONTROL

Channel 10 is used for transport control. Each octave controls one sequence:

The lowest octave (Offset 35) controls sequence 1, the next octave sequence 2 etc,...

Play, (C)

Pause, (D)

Stop, (E)

Prev Cue + Play, (F)

Prev Cue + Pause (F#)

Next Cue + Play (G)

Next Cue + Pause (G#)

#### GUI - Configuration Tab

Midi Device: Choose an installed Midi Device.

ID: ID of MSC Message Mapping

Sequence: Choose the sequence to be controlled via MSC.

Run Midi: Launch MSC and MIDI Input.

### 5.5.1.3 MSC MIDI SHOW CONTROL

The Midi Show Control input protocol supports System Exclusive messages (SysEx) according to the MSC specification.

#### MSC SEQUENCE CONTROL

The format of a MSC (Midi Show Control message) is defined as:

F0h 7Fh <device\_ID> 02h <command\_format> <command> <data> F7h

(<data> is optional, all others are needed)

<device\_ID>

determines the ID of the sequence to control. This is set up in the MIDI menu in the configuration tab.

<command\_format>

The following command-formats are processed by Pandoras Box:

01h Lighting (General Category)

30h Video (General Category)

40h Projection (General Category)

7Fh All-Types

<command>

The following commands are processed by Pandoras Box:

01h GO

02h STOP  
 03h RESUME  
 05h LOAD  
 06h SET  
 0Ah RESET  
 0Bh GO\_OFF

<data>

All data must be encoded in ASCII Format.

Multiple data elements must be separated (SET) with 00h.

Separators as dec.(2Eh) are accepted but the next value is not processed.

#### Example for:

GO to Cue 24:

F0h 7Fh <device\_ID> 02h 7Fh 01h 32h 34h F7h (min required format)

also valid:

F0h 7Fh <device\_ID> 02h 7Fh 01h 32h 34h 2E 30 30 31 00 F7h (equivalent to cue 24.001 – is processed as Cue 24)

F0h 7Fh <device\_ID> 02h 7Fh 01h 32h 34h 2Eh 30h 30h 31h 00h 31h 00h 32h 00h F7h  
 (according to the GrandMA format with cue list and cue path – only the first cue is processed)

GO - in conjunction with a cue:

Jump to Cue + Play (the cue will overwrite a previously loaded cue)

GO - without a cue:

a) if the last command was a LOAD cue, the loaded cue will be called.

b) in all other cases the timeline will continue from its actual play position.

STOP

Pause

RESUME:

Play at the actual position of the timeline.

LOAD:

LOAD must be used with a cue. The loaded cue will be processed by the next incoming GO command.

RESET and GO\_OFF

Stop

SET

Set allows you to transmit individual device parameters. The message consists of 4 values.

MSC PARAMETER CONTROL

F0h 7Fh <device\_ID> 02h <command\_format> 06h <data1> 00h <data2> 00h <data3> 00h <data4> 00h  
 F7h

Only data after a 00h-separator will be processed. All decimal values will be ignored.

<data1>: Device ID

<data2>: Layer ID

<data3>: Parameter ID in Pandoras Box

<data4>: Value

Sample message for Device 1, Layer 3, X-Position, new value 26465:

F0h 7Fh <device\_ID> 02h 7Fh 06h 31h 00h 33h 00h 38h 00h 32h 36h 34h 36h 35h 00h F7h

List of Pandoras Box Parameter IDs:

None 0	Mode 31
Opacity 1	KSL 32
Mesh 2	KSLR 33
Media 3	KSR 34
Inpoint 4	KSRR 35
Outpoint 5	KST 36
Transport 6	KSTR 37
TransFx 7	KSB 38
XPos 8	KSBR 39
YPos 9	LinX 40
ZPos 10	LinY 41
XRot 11	SEL 42
YRot 12	SELC 43
ZRot 13	SER 44
XScale 14	SERC 45
YScale 15	SET 46
ZScale 16	SETC 47
Colour1 17	SEB 48
Colour2 18	SEBC 49
Colour3 19	Sonic Emotion device:
ColourFx 20	BLevelS 50
Fx1 21	BLevelR 51
Fx2 22	BLevelG 52
Fx3 23	BLevelB 53
VideoFx 24	Volume 54
XAxis 25	X 55
YAxis 26	Z 56
ZAxis 27	RoomSize 57
Rot 28	Ambience 58
XOffset 29	Diffusion 59
YOffset 30	

All commands but SET are sequence related controls. The sequence to control must be set in the MIDI configuration tab.

GUI:

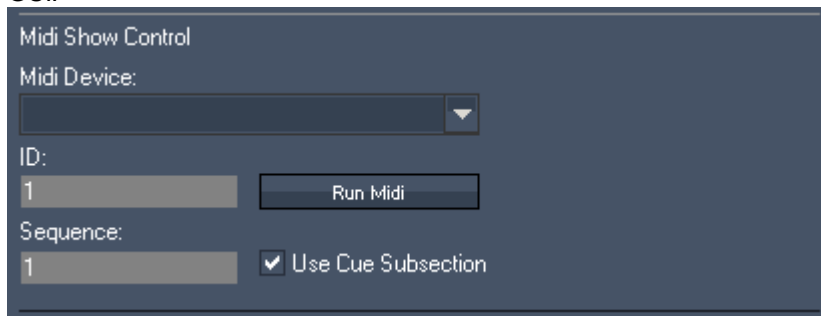

Midi Device: Choose an installed Midi Device  
 ID: ID of MSC Message Mapping  
 Sequence: Choose the sequence to be controlled via MSC  
 Run Midi – Launch MSC and MIDI Input

Use Cue Subsection:

As decimal places for cue numbers are not supported in Pandoras Box, you can use the check box option "Use Cue Subsection". Doing this will multiply the incoming cue command x1000 (for example: GO to Cue 1.020 will be interpreted as GO to Cue 1020). With this option three decimal places are supported.

#### 5.5.1.4 SERIAL LINK

**Please note, that coolux has discontinued the Serial Link. Please refer to [JLCooper Electronics](#) and their product [eBOX](#).**

The optional external SERIAL Link interface provides 4x serial RS 232/422 ports via ethernet. A SERIAL Link port can be used to control the playback control of the timeline via RS232 or RS422. Each port can be connected to a separate sequence to allow multiple input devices to control individual sequences.

Once the serial connection is set up, the following commands are valid:

(Play)

Sets the sequence state to play

(Pause)

Sets the sequence state to pause

(Stop)

Stops and rewinds the sequence

(CueID)

ID = enter number based on cue ID to jump to that cue directly

Example:

(Cue13), sets the timeline now-pointer to the time of cue 13

See further instructions in the [Serial Link Device Manual](#)<sup>729</sup>.

#### 5.5.1.5 SMPTE INPUT

All Pandoras Box Manager, Server or Player products with timelines can send and receive LTC SMPTE via the [USB SMPTE Link interface](#)<sup>735</sup>.

To connect the SMPTE Link please refer to [Configuration tab](#)<sup>139</sup>, section [SMPTE Time Code](#)<sup>157</sup>. Then go to [Sequence Inspector](#)<sup>200</sup> to set up the "Mode", "Offset" and "Stop Action".



### 5.5.1.6 TCP/IP

If you need to interface with Pandoras Box via Ethernet, TCP/IP communication is there to enable you to remote control sequences and cues.

For external control you may create a TCP/IP server connection for each sequence that uses TCP/IP Port 23. This can be set up in the [Sequence Inspector](#)<sup>200</sup>.

The packet data is formatted as follows:  
FFh 00h 00h nn <data>

nn defines the virtual com port 00h, 01h, 02h or 03h that can be set in the serial device in Pandoras Box Manager, for direct IP communication without a [Serial Link](#)<sup>729</sup> interface you may ignore these virtual port values.

Once the connection is set up, the following commands are valid:

(Play)

Sets the sequence state to play

(Pause)

Sets the sequence state to pause

(Stop)

Stops and rewinds the sequence

(CueID)

ID = enter number based on cue ID to jump to that cue directly

Example:

(Cue13) sets the timeline nowpointer to the time of cue 13.

### 5.5.1.7 UDP - PB AUTOMATION

For custom remote control application, PB Automation uses a UDP based ethernet protocol to allow you both sequence and device input control to all available devices within your project.

For more information about the integration and use of the PB Automation SDK please refer to the [SDK description](#)<sup>1532</sup>.

## 5.5.2 OUTPUT PROTOCOLS

Pandoras Box show control communication architecture allows various devices to be controlled via several industry standard protocols.

### 5.5.2.1 DMX OUTPUT

DMX output is designed to remote control external DMX device from the timeline in the Pandoras Box master, i.e a Manager, Player or Server. You may for example program a synchronized light and video show by including moving lights, spots and other possible DMX devices into the timeline.

If you, on the other hand, are interested in controlling Pandoras Box with a lighting desk for example, please read the topic covering the [DMX Input](#)<sup>[621]</sup>.

For any DMX output the following settings need to be done.

#### 1 - Connection

Connect the master system to the DMX devices.

#### 2 - Patch

All Pandoras Box systems ship with an extensive library of DMX devices. You may access all [built-in DMX devices](#)<sup>[607]</sup> in the [Device Type tab](#)<sup>[181]</sup>. Simply drag and drop the desired library into the [Device Tree](#)<sup>[168]</sup>. If your device is not included, you may write a custom fixture and then drag your [custom device](#)<sup>[608]</sup> into the Device Tree.

Select your device and patch the channel, subnet and universe using the [Patch tab](#)<sup>[222]</sup>.

#### 3 - Configuration

Activate the DMX output in the [Configuration tab](#)<sup>[139]</sup> in the section [Remote Control Protocols](#)<sup>[146]</sup>. You can choose a dedicated network adapter.

As soon as a key is stored in the [timeline](#)<sup>[260]</sup>, the DMX data will be sent constantly. Only changes to DMX values will be sent over Art-Net. Resetting a DMX node will send all values at once.

### Art-Net

As one of the most popular Ethernet protocols, Art-Net can be used to control multiple units with multiple DMX universes via a single Ethernet network.

To use Art-Net please make sure that the lighting system and the Pandoras Box system are in the same IP address range.

The first Art-Net specification demands a 2.xxx.xxx.xxx IP address, the most common used subnet mask is 255.0.0.0 . Pandoras Box is still tied to this specification when working with DMX fixtures (i.e. sending Art-Net data). If you are working with [matrix patches](#)<sup>[757]</sup>, you may address a different IP range there. Since version 5.3 the IP address does not necessarily need to be in the 2.x.x.x range to be able to receive Art-Net.

To enable Art-Net within a Pandoras Box Master system, please activate the Art-Net Mode in the [Configuration tab](#)<sup>[139]</sup>.

### DMX Link Out

DMX output via USB is supplied by the [DMX Link USB interface cable](#)<sup>[735]</sup>. To enable it, press the output button "DMX via USB" in the [Configuration tab](#)<sup>[139]</sup>.

Please be aware that a single USB DMX interface will allow you to control a maximum of 512 DMX channels on subnet 0 and universe 0.

## DMX Link 8

The DMX link 8 converts up to 10 DMX universes to Ethernet (Art-Net protocol). Backwards, 8 DMX universes can be converted from Art-Net to DMX.

Please see the [DMX Link 8 Device Manual](#)<sup>736</sup> for further information.

### 5.5.2.2 SERIAL LINK

**Please note, that coolux has discontinued the Serial Link. Please refer to [JLCooper Electronics](#) and their product [eBOX](#).**

The serial control will give you access and control to most routing switchers, projectors, shutters or other device parameters that are remote controllable via the common RS 232 and 422 serial protocols.

In order to control external serial devices over RS 232 or RS 422 you will need to add a serial link device from the [Device Types tab](#)<sup>181</sup> to the [Device Tree tab](#)<sup>168</sup>. Any serial ASCII or hex string can be stored and copied to any point in the timeline. It can be recalled at any time the time cursor hits the stored serial key. Once you set the first key you can assign the IP address and port ID in the keys properties as well as the ASCII or hex command for that key.

You will need a serial link device to receive and output serial commands. See further instructions in the [Serial Link Device Manual](#)<sup>729</sup>.

Please see the topic [TCP/IP](#)<sup>644</sup> for an example how to control a projector without the Serial Link hardware itself.

### 5.5.2.3 SPARK

for WINDOWS XP (Microsoft .Net 2 Runtime must be installed)

Spark offers you various remote control over external applications as well as standalone Windows XP PCs.

Spark is designed to be connected to any Pandoras Box timeline as a [Serial Link](#)<sup>729</sup> TCP IP device.

Spark can be used for remote controlling applications, mouse and keyboard actions as well as displaying full-screen video playback and web page presentations among many other useful remote control features. Pandoras Box Spark is available from the coolux website as freeware download [www.coolux.de](http://www.coolux.de).

To get started, install Spark on the desired PC that you want to control (Spark can be accessed also on the same machine that runs Pandoras Box)

#### COMMAND LIST

See here an overview of remote control features offered by Spark:

#### COMPORT ASCII COMMUNICATION

#### SYSTEM COMMANDS - Shutdown & Reboot

#### WEB BROWSER (Fullscreen)

#### SOUND COMMANDS

#### VIDEO PLAYER (Fullscreen)

## APPLICATION COMMANDS

### KEYBOARD EVENTS

### MOUSE EVENTS

### DESKTOP FADE TO BLACK -BETA

### WAKE ON LAN

### PB AUTOMATION REMOTE CONTROL

Please see [Spark](#)<sup>614</sup> for detailed information.

#### 5.5.2.4 SMPTE OUTPUT

All Pandoras Box Manager, Server or Player products with timelines can send and receive LTC SMPTE via the [USB SMPTE Link interface](#)<sup>735</sup>.

To connect the SMPTE Link please refer to [Configuration tab](#)<sup>139</sup>, section [SMPTE Time Code](#)<sup>157</sup>. Then go to [Sequence Inspector](#)<sup>200</sup> to set up the "Mode", "Offset" and "Stop Action".

#### 5.5.2.5 TCP/IP

With the Serial Link device you may control most routing switchers, projectors, shutters or other device parameters that are remote controllable via the common RS 232 and 422 serial protocols. Even though, the device's name is Serial Link, you do not necessarily need the [hardware device itself](#)<sup>729</sup>.

For TCP/IP output, please open the [Device Type](#)<sup>181</sup> library and drag the [Serial Link device](#)<sup>608</sup> to the [Device Tree](#)<sup>168</sup>.

Select the device in the tree to load its properties into the [Inspector tab](#)<sup>188</sup>. Since the Serial Link device uses a direct TCP/IP communication, you will need to switch off "Use Serial Link header".

Now, type in the right IP address of the projector (or any other device) and its connection port. The Christie Mirage 3D projectors for example listen to port 3002. The IP and port can be either set on the device itself or they are predefined. Please check the device's manual.

Click the button "Apply IP and Port" and the red exclamation mark on the Serial Link device in the Device Tree disappears which means that you are connected to the projector. Some devices cannot open two connections at the same time. In that case please close any other remoting ports, this includes also interfaces for browsers.

As the connection is now established, the commands can be send. Simply add the serial command according to the device's syntax as a key to the timeline. In detail this means to open the parameter "COM" and insert a key frame by right-clicking on the according time whenever you want to send commands to the projector.

Then select the created key frame and edit it in the Inspector. Enter the command in the "Data" field. Please refer to the user manual of the projector to get the specific commands you want to send. For example, (SHU 0) or (SHU 1) are common commands to open and close the shutter. The round brackets are not requested from Pandoras Box but most devices demand that a command is enclosed with brackets. If your device demands to send a special character like a "carriage return" or "start of text" send your entire message "As Hex" and write everything including that special character using hexadecimal values. You may find a list with [ASCII characters](#)<sup>970</sup> and the according hex code in the Widget Designer chapter.

---

As soon as the nowpointer reaches the key frame the command is send via the TCP connection to the projector. In that way any serial ASCII or hex string can be stored and copied to any point in the timeline.

## 5.6 NETWORK & SYNCHRONIZATION

Pandoras Box Systems rely on a dedicated network architecture that enables fast file sharing and management as well as a proprietary frame adaptive network video-synchronization.

### 5.6.1 NETWORK SETUP

To run Pandoras Box Server over Ethernet, the IP setup of your system is essential.

The coolux **MediaNet** allows you to link any Pandoras Box product together via MediaNet (this feature is disabled in standalone mode). The MediaNet takes care of the synchronization of the units and allows you to remote control and share files via Ethernet within the Pandoras Box software. For this a TCP (via port 1234) and UDP (via port 1235) protocol is used.

**Art-Net** is available as an open industry standard DMX protocol via Ethernet.

It allows transporting multiple DMX universes on a single Ethernet link. Therefore the protocol offers subnets and IDs that a DMX universe can be assigned to. If your controller does not support Art-Net natively, you might use an Art-Net converter, which converts standard DMX signals into Art-Net. They are available i.e. from Artistic License or ELC.

Since Art-Net is sending UDP packets, this may slow down regular computer networks for office use. It could also interfere with ongoing downloads that may result in dropping DMX frames that will cause image jittering.

So please make sure that Art-Net runs on a separate network that is not connected to “normal” computer network or internet.

#### SYNCHRONIZATION

The way Pandoras Box synchronizes all control data for vector calculations as well as for video playback has been optimized, so that you simply have to set up a project that contains all connected units in the network.

Therefore one unit acts as a Master while all other units connected to it become Clients. A Client is fully independent. The unit gets its resource and control data from the Master system only. In the project you may define which resources should be assigned to which Client. At the same token, the Master system will automatically take care of the full synchronization of all motion and video-only data. Even if you encounter a performance drop on one of the machines, it will catch up once the necessary resources are available.

#### IP CONFIGURATION

For a proper network communication and bandwidth, we strictly recommend setting up standalone local area networks.

To receive MediaNet or Art-Net with your Pandoras Box Server, any firewall needs to be switched off! By factory default the internal Windows firewall is switched off! When building up the network-link you may either use straight peer-to-peer connection with a cross-link cable or use regular network cables in conjunction with an Ethernet hub or switch.

If you like to configure your firewall differently, keep in mind that the Pandoras Box master and clients communicate via port 1234 and 1235!

#### **Please note:**

Some switchers and routers include filtering or even a firewall that won't let MediaNet or Art-Net data through.

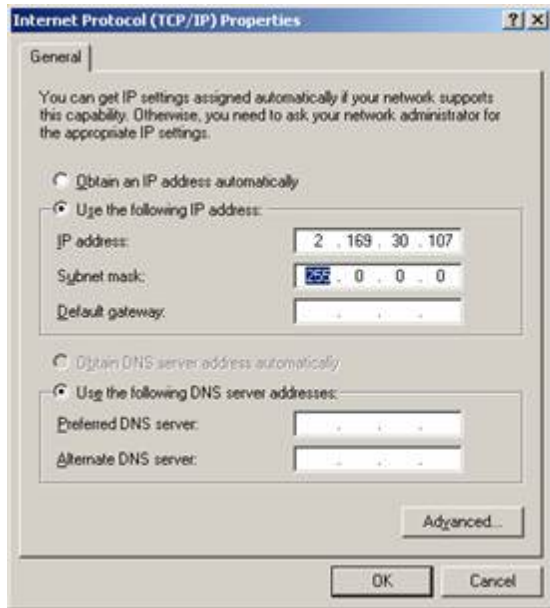

The IP address of your Pandoras Box Server needs to be set in the range of 2.xxx.xxx.xxx with the subnet mask 255.0.0.0 if you like to send Art-Net data. For receiving MediaNet or Art-Net any IP address can be chosen.

The IP address can be changed in the properties of the network connection. You may also use Art-Net with a DHCP server that sets all IP in the same 2.xxx.xxx.xxx address range.

## 5.6.2 MASTER / CLIENT REMOTE SETUP

### General explanation: PB Master, PB Client

If you have only one Pandoras Box system, you start the Master mode. This configuration is also called "stand-alone mode".

When multiple Pandoras Box systems need to be linked, e.g. for synchronized video playback, they need to be set up in a Master/Client configuration. A Master system may connect to multiple Client systems whilst a Client may only connect to one single Master system. Pandoras Box Playback systems (PB Players and PB Servers) may be started in either Master or Client mode. The PB Manager has only a Master mode.

You run one Pandoras Box Manager or Player or Server as a Master and start the Client mode on all other machines.

The Master acts in general as the main controller for all attached devices, whilst a Client system is "only" receiving commands and media to playback in fullscreen.

On the Master, you create a project which holds all information about the resource media files and connected Clients (and other [devices](#)<sup>296</sup>). The Master takes care of the remote file management, meaning the media upload called "spreading" to all Clients; and of course the video synchronization throughout the entire network. In addition the Master send all control parameters to the Clients and organizes the protocol patch and routing, e.g. it sends all incoming control-data like DMX or Art-Net in sync to the Clients.

### Revision number and Domain channel

In order to connect Master and Client systems, please make sure that the identical software revision is used and that both Master and Client use the same domain channel for communication.

The revision number is displayed in the bottom right corner of the Master interface. In the Client GUI the revision number is displayed next to the preview window when the fullscreen mode is off.

The domain channel can be found in the [Configuration tab > Network](#)<sup>146</sup> in the Master system and in the main window of the Client. Per default, the domain channel is set to 0 and is only changed when multiple Masters or multiple PB networks need to be set up.

So if multiple Masters exist within the same network, assign different domain channels to them. Two Masters may not share the same domain channel. Choose the domain channels for your Clients according to the Master it should connect to. For the other Master, this Client is invisible.

### Controlling Clients in the Master interface

When the network, the revision and the domain are set up correctly, all Clients appear in the [Assets tab](#)<sup>137</sup> of the Master. The Clients in return display the Master's IP instead of "not connected".

To start controlling the Client, for instance assigning media files to it, drag the unit from the Assets tab into the [Device Tree tab](#)<sup>168</sup>. Now the Client is in the project and files can be transferred across the network.

To include media files to your project, drag the file from the Assets tab to the [Project tab](#)<sup>248</sup>. Per default, all added media files are auto-spread to the available Clients (that are part of the Device Tree). To share files or entire folders manually, you right-click on the entry in the Project tab and choose the according 'Spread' command.

Now you can start assigning the sources (media files) to the outputs (Layers on the Clients). This is explained in the chapter [Media Files](#)<sup>248</sup>.

Please note:

When re-starting the project on the Master with unconnected Clients, they will show up with a red"!". Once the Clients are started, they will automatically reconnect to the Master

### Programming with Clients that are not connected yet

If you want to assign a client that is not connected to the network yet, you can also choose the Pandoras Box Client type from the [Device Types tab](#)<sup>181</sup> and drag it into the project from there. Once the unit will be present on the network, make sure that you set the correct IP address in the [Client's Inspector](#)<sup>206</sup> in order to be connected to the Master.

## 5.6.3 VIDEO SYNCHRONISATION

Pandoras Box Systems offer a network based automatic frame adaptive video synchronization.

No matter the input protocol, once a Master/Client setup is set up, all control data that is sent across the network via Pandoras Box MediaNet will be processed in sync on all connected Client machines.

A few words about video synchronization and timecode sync:

In order to deliver a frame accurate synchronization all connected Client systems synchronize themselves with the Master at any time. This means that - independent from running sequences videos that are played back in play loop - freewheel mode will stay in sync with each other. This is also important for external input protocols that do not provide a synchronization method like DMX, GPI or many others.

The remote input protocol commands are collected as a series of commands on the Master unit and then processed in sync to the Master's time clock for each configuration.

It also very important, when video synchronization should be used, that all videos are used as elementary video files only, otherwise the embedded audio will disconnect the video sync and sync to the audio only.

This is important for content production and encoding: If you want to playback audio files in sync to an entire network system, the audio files must be played back through the sonic emotion audio device built into every Master system.



---

The sonic emotion real-time audio player and time synchronizer ensures that all audio files that are played back through dedicated audio track will stay in sync with the Masters time clock.

## 5.7 STREAMIX LIVE INPUT

StreamiX Desktop is a TCP based Desktop Streamer that works as a Live Input in Pandoras Box (PB). This tool streams any Windows XP / Win7 desktop region, for example a dedicated area of an Excel sheet or any other application content, and may be used as a Live Input of a PB Client or PB Master directly. In addition it may stream a chosen file from the hard disk. In return you might as well stream the preview area to other PB clients.

This way you can send any desktop content directly into Pandoras Box without using capture cards. As the content is transferred via TCP please keep in mind that the tool is not designed to be a fully-fledged substitution for DVI input cards. It is rather meant to stream either low frame rate content or single images or low resolution content.

To meet the systems performance it is possible to set up different frame-rates and sizes of the desktop region to be streamed.

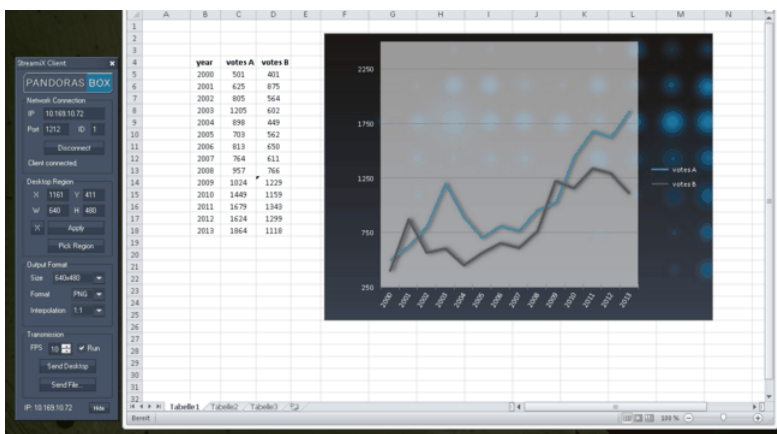
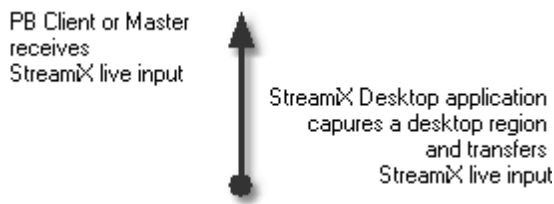
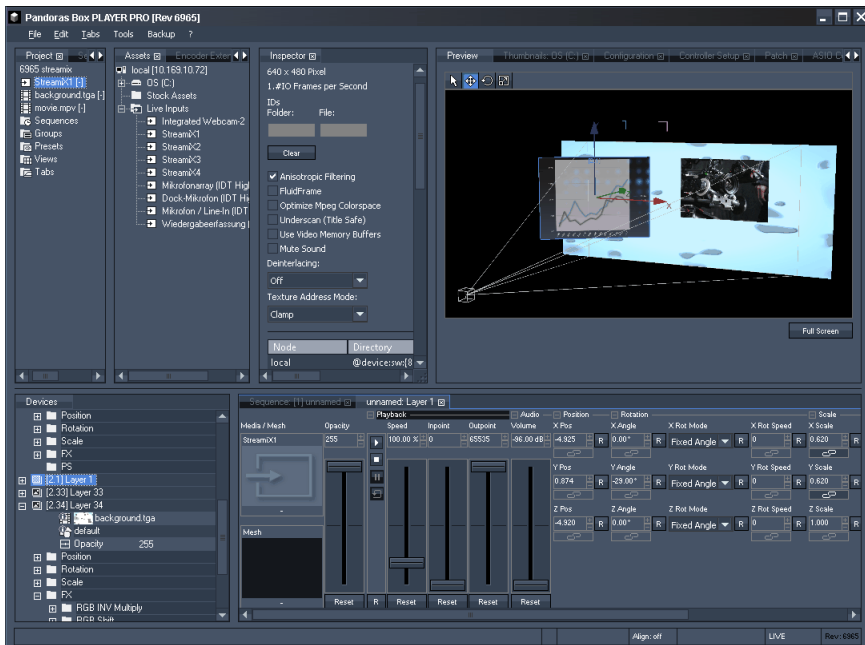

Even though StreamiX is designed to be used as a 1:1 connection, you may use several instances of StreamiX Desktop at the same time on one system. These may either send their data to a single PB Client or to several PB Clients.

In return one PB client may receive data from several StreamiX Desktop applications. However, keep your systems performance and network traffic in view, a 1:1 stream may be already the limit!

By rule of thumb one stream with a resolution of 1024x768 px and a frame rate of 30fps will run fluently on a gigabit network.

The total number of StreamiX Live Inputs depends on the license of your PB Client. See the [Product Overview](#)<sup>651</sup> for detailed differences.

The Pandoras Box CITP based Desktop Streamer for users of WYSIWYG or Capture Polar is described [here](#)<sup>656</sup>.

**5.7.1 STREAMIX DESKTOP USER INTERFACE**

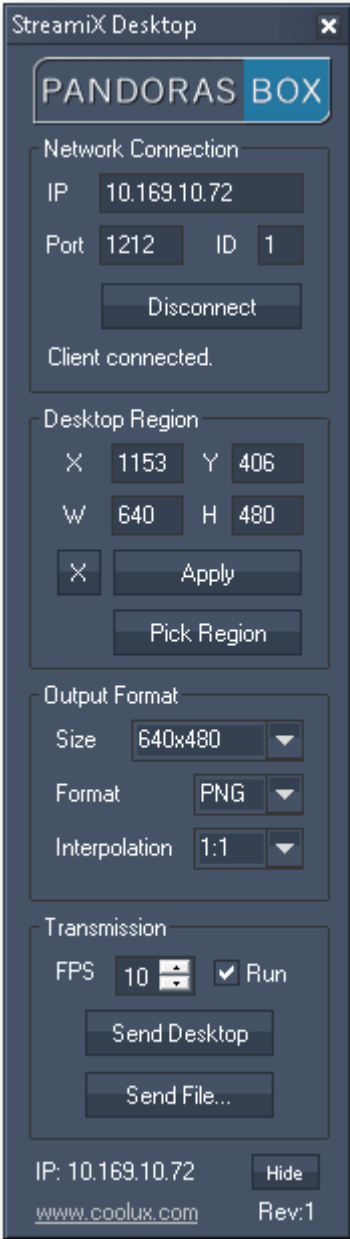

The User Interface is divided into the following sections:

- [Network Connection](#)<sup>652</sup>
- [Desktop Region](#)<sup>652</sup>
- [Output Format](#)<sup>653</sup>
- [Transmission](#)<sup>654</sup>
- [General information](#)<sup>654</sup>

### 5.7.1.1 NETWORK CONNECTION

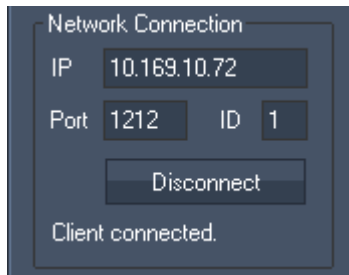

You may start several instances of StreamiX Desktop Streamer at the same time to pass several TCP streams to PB application. The number shown in the Window Title [] displays the stream number: Pandoras Box CITP Desktop Streamer [1] = Stream 1.

[IP]:

Enter the IP address of the PB Client (or PB Master if stand alone) you want to sent the stream as a live input to.

[Port]:

Enter the same port as the receiving PB application is set to.

[ID]:

Enter the ID. Each stream received from the PB Client (or PB Master) must have a unique ID and refers to the StreamiX Live Input with the same number.

[Connect / Disconnect]:

Click [Connect] to connect to the device with the entered IP and Port. As StreamiX Desktop is a TCP client, the connection must be built up in the first place from the PB Client (or PB Master) as this device poses as the TCP server. Please set up the stand alone Master first, or if a PB Client is used, it must additionally be part of a project and the live input must be added to it as an asset already.

After you have done so the TCP connection can be built up and the StreamiX Desktop can pick it up. The text "Waiting for connection..." will change to "Client connected". When the button [Disconnect] is pressed you will read "Client stopped".

In case of closing the PB Client or Master receiving the StreamiX live input "Server lost" will be displayed.

### 5.7.1.2 DESKTOP REGION



There are two possibilities to define the region of your desktop that is going to be captured for TCP streaming:

Enter the region's starting horizontal pixel [X] and the vertical pixel [Y] as well as the regions width [W] and height [H] into the text fields and press [Apply].

Or click [Pick Region]. The desktop will be overlaid with a transparent white mask and you may span the desired desktop region with the mouse.

Please note:

To capture a desktop region that is not on the primary monitor, enter the region's starting pixel and its size as described in option 1. This can't be done by picking a region with the mouse.

The example shows a typical use. By picking a smaller region, you will stream the graph only without the surrounding columns and rows within the table.

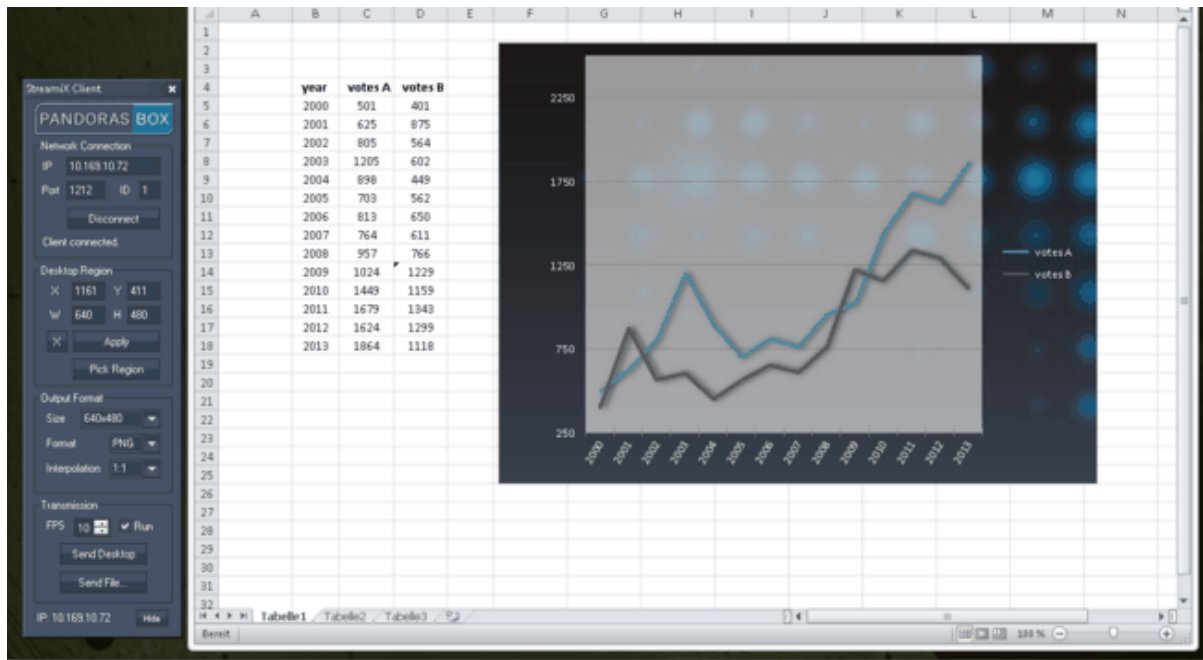

### 5.7.1.3 OUTPUT FORMAT

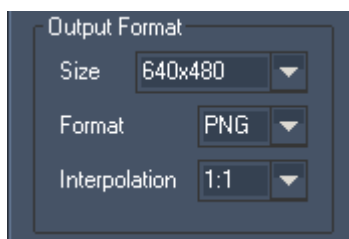

[Size]:

By choosing a size from the drop-down list you define the resolution and aspect ratio of the outgoing stream. Picking the same (or at least a multiple unit) in regards to the captured desktop region and Live Input setting will give you the best result.

[Format]:

Choose whether the frames of the stream are to be encoded as jpeg or png format.

[Interpolation]:

If a size has been picked that does not match the captured desktop region, the pixel within the new width and height have to recalculated. Choose whether the calculation should base upon 1:1, Cubic, Linear or Soft interpolation.

### 5.7.1.4 TRANSMISSION

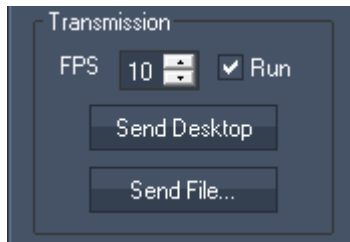

**[FPS]:**

The Framerate can be set to values between 1 and 30 fps, according to your system's performance and network's capacity.

Please note:

You do not have to press [Apply] as your changes are applied immediately.

**[Run]:**

Enable the check box to stream successive frames of the desktop.

Disable the check box to stream a single image only. This may either apply to a desktop or file stream.

Please note that the check box is ticked automatically by the following buttons as well.

**[Send Desktop]:**

Captures the assigned desktop region with the assigned format and enables automatically the check box [Run]. However, you may tick it again in order to stream a single screen shot of the desktop. This will not interrupt the TCP connection itself but the capturing process.

**[Send File...]:**

Streams a file from the hard disk and disables the [Run] option. Please note that only single images (\*.bmp, \*.jpg, \*.png, \*.gif)\*.may be streamed.

### 5.7.1.5 GENERAL INFORMATION



On the left bottom of the menu you find the local computer's IP address and a link to coolux' website.

On the right bottom the revision is displayed.

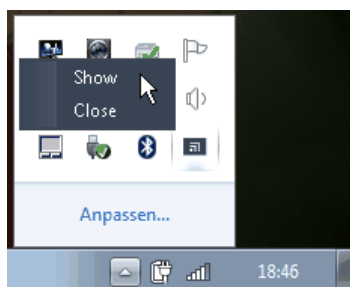

The [Hide] button will hide the user interface (menu) of StreamiX Desktop. To unhide it again, open the system tray and make a right-click on the StreamiX Desktop icon or make a left click and choose "Show".

### 5.7.2 STREAMIX LIVE INPUT SETTINGS

As the StreamiX Desktop application can only pick connections up, it is necessary to establish them with the PB Client (or Master) beforehand. To do this you need to configure the live input. StreamiX is designed to be used as a live input on a Pandoras Box Player or Server, it is not available on a PB Manager. The Player or Server System may run in stand alone mode or as a PB Client.

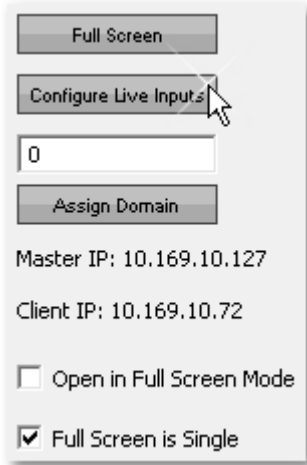

In order to configure the StreamiX live input on a PB Client, the client must be part of a project and the live input must be added to it as an asset already.

As live inputs are only available (and render-able) on the system were the physical input is, all other system including PB Manager cannot display the input. In order to preview a dummy file, select the StreamiX asset and use the attach function on the local node. Scroll down the Inspectors window, highlight "local" and click the "Attach" button. Choose the file you want to preview instead of the non-existing live input and Click "Ok".

In order to configure the StreamiX live input on a PB Master (PB Player or PB Server) drag the StreamiX live input from the Assets Tab to the Project Tab as well. Select the StreamiX asset and have a look at its options in the Inspector Tab. Scroll down, select the local entry and click the button "Configure".

Change the incoming resolution and the listening port.

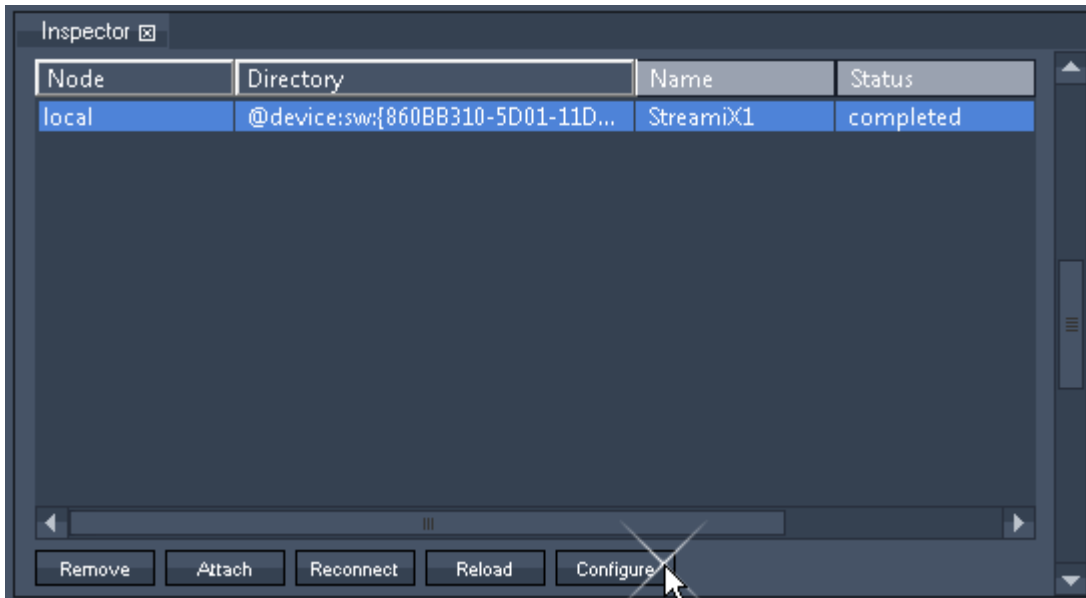

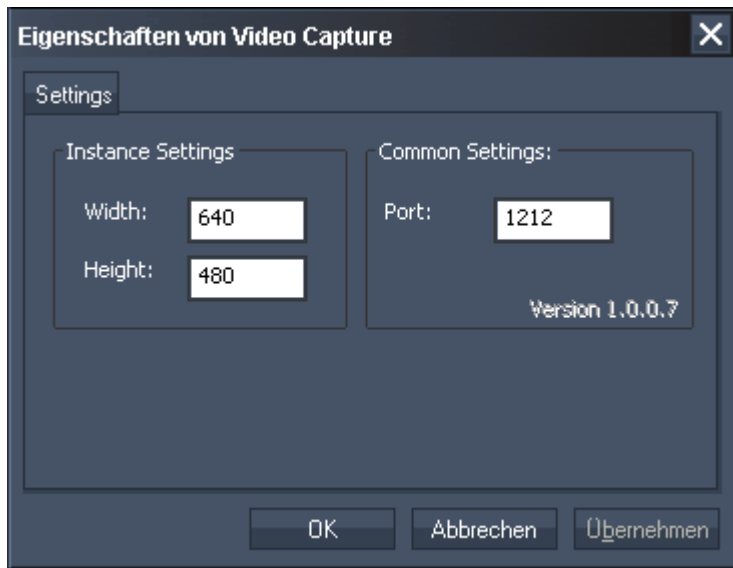

Now the StreamX live input may be used just like any other still image or video file. It is possible to assign it to a layer and use it in the sequence as usual.

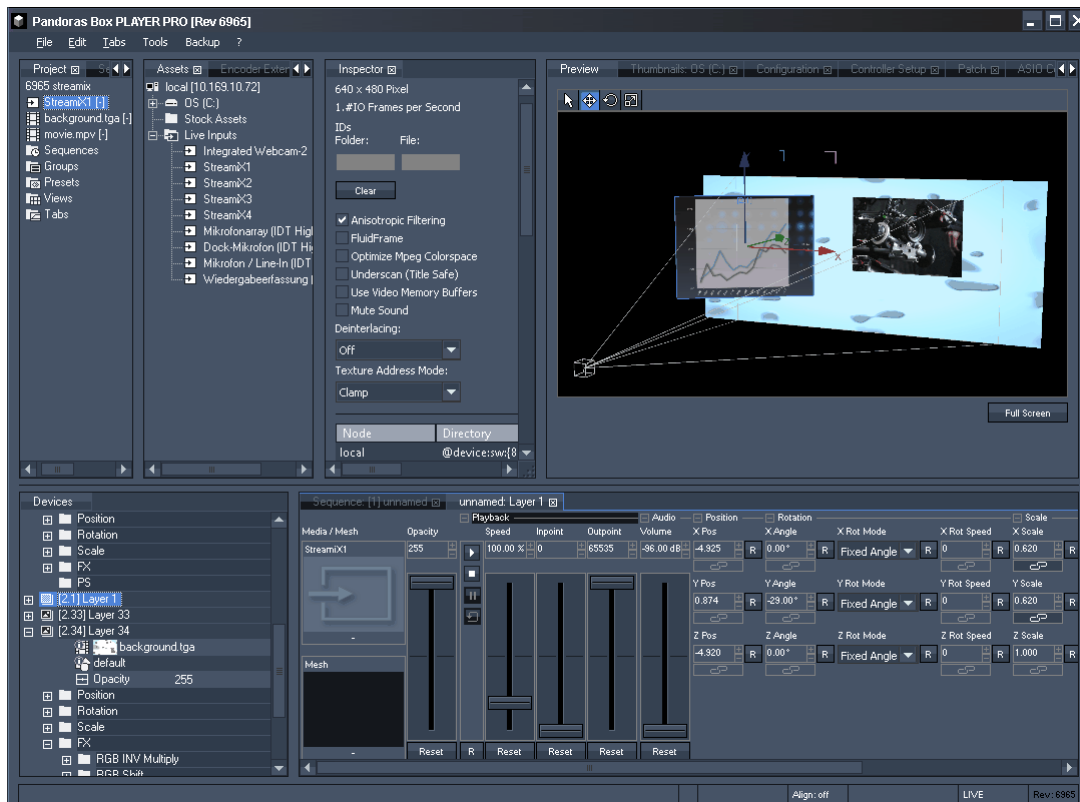



## 6 FACTORY RESET TOOL

The factory reset tool is especially useful for rental machines. On the one hand it allows you to create disk images i.e. a backup of the system including all files, programs, driver versions, computer names and all other structures and settings. On the other hand it allows you to restore the system by loading created images. At all times an image is provided, representing the system's condition when it has been shipped out (with all recommended settings and drivers!)

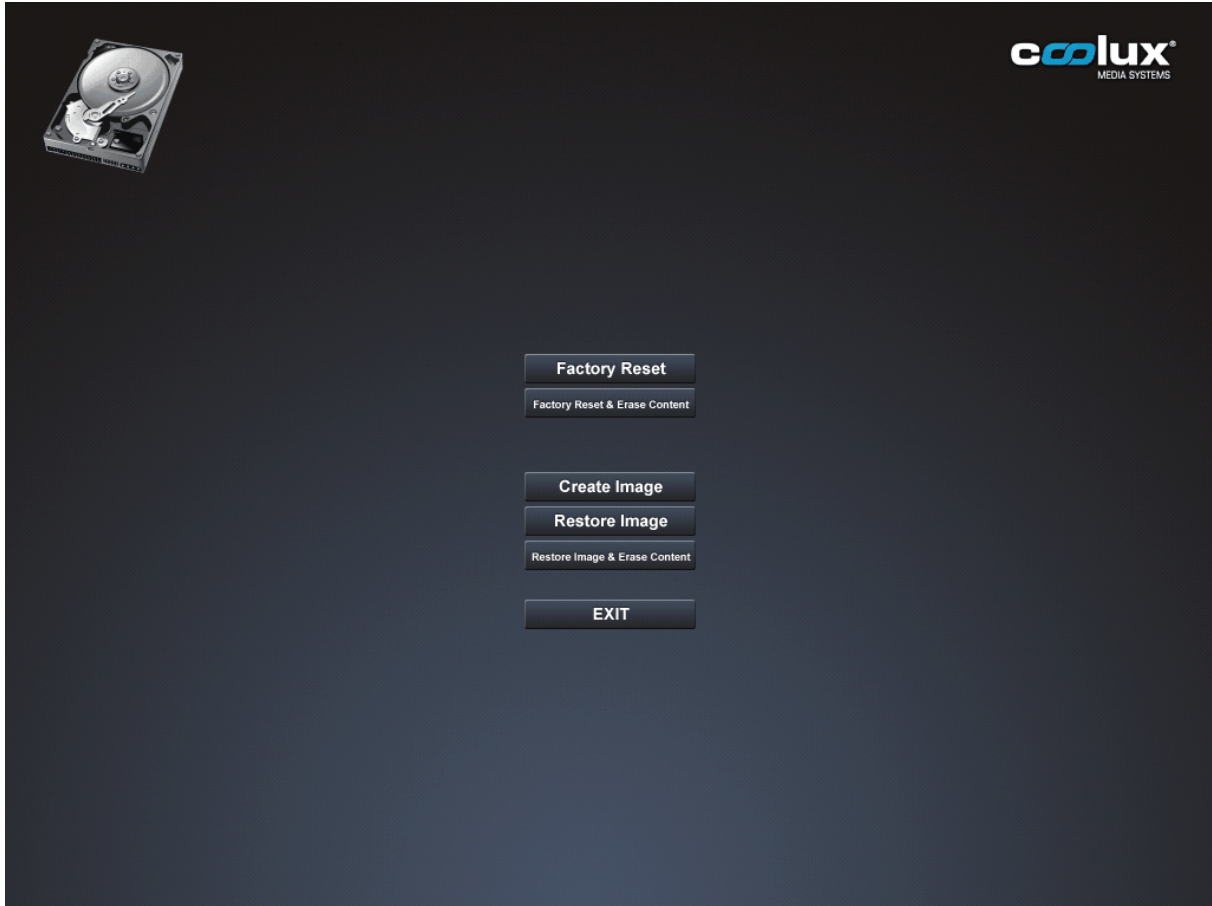

The tool is available on V4Rev2 hardware which has been sold since the V5 release.

Please note: Until now, all images affect only the c-drive itself. The content partition is embedded into the c-partition, nevertheless it cannot be included when saving a backup, nor does a backup restore the content partition.

If you wish to delete certain content files from prior users, we advise to do this manually in the windows browser. Please be aware that the content partition has no bin, thus by deleting them and confirming the warning, you cannot restore them anymore

The user interface of the factory reset tool appears on each start up (booting process) after successfully booting the BIOS. If it is not entered actively within 5 seconds the system will continue booting and the Windows boot screen appears.

In order to halt the booting process and enter the active state of the tool, press one of the arrow keys on your keyboard. You will see this screen until the Exit button is pressed.

Navigate through the user interface by pressing the up and down keys. Press enter to confirm.

---

### Factory Reset

Restores the c-drive to the factory setting. The factory reset image is a read-only file. It cannot be overwritten or deleted.

The content partition (c:/coolux/content) will remain as it is.

### Factory Reset & Erase Content

Restores the c-drive to the factory setting and erases the files from the content partition (c:/coolux/content). All files will be deleted. There is no backup of the content partition stored separately!

As soon as a Pandoras Box application (client or master) will be loaded the first time the folder \_Pandoras\_Box\_Data with its subfolders will be recreated.

### Create Image

Draws an image from the current system. The image file will be saved on an additional rescue partition (60GB). Please be aware that the latest image will be overwritten by the recent image. There is a warning message you will have to confirm before saving a new image and possibly overwriting an older one. This does not affect the factory reset image which is stored separately!

The content partition (c:/coolux/content) will not be included in the image.

### Restore Image

Restores the c-drive to the status when the latest image has been stored.

The content partition (c:/coolux/content) will remain as it is.

### Restore Image & Erase Content

Restores the c-drive to the status when the latest image has been stored and erases the files from the content partition (c:/coolux/content). All files will be deleted. There is no backup of the content partition stored separately!

As soon as a Pandoras Box application (client or master) will be loaded the first time the folder \_Pandoras\_Box\_Data with its subfolders will be recreated.

### EXT

Leaves the user interface from the factory reset tool. The booting process will continue and Windows will load.

## 7 HARDWARE AND ACCESSORIES

This topic focuses on the hardware description of coolux products.

First of all topics are included that explain hardware peripherals, included in Server, Player or Manager hardware:

- [LCD Menu](#)<sup>659</sup>
- [DVI Processor](#)<sup>662</sup>
- [Graphic Card Settings](#)<sup>675</sup>
- [Input Card Settings](#)<sup>692</sup>

Then, hardware devices are described that work as an optional feature. They can be purchased as stand-alone accessories.

- [Controller Boards](#)<sup>708</sup>, i.e. [Jog Shuttle Controller](#)<sup>709</sup> and the [Fader Extension](#)<sup>710</sup>
- [SENSOR Link](#)<sup>716</sup>
- [SERIAL Link](#)<sup>729</sup>
- [SMPTE Link](#)<sup>735</sup>
- [DMX Link](#)<sup>735</sup>
- [DMX Link 8](#)<sup>736</sup>
- [EDID Link](#)<sup>741</sup>
- [NET Link and Calibration Link](#)<sup>747</sup>

### 7.1 LCD MENU

The LCD Menu is included in the Pandoras Box Servers, it cannot be purchased as an optional features.

#### Status Display

The top level menu of the front panel LCD display is the status display.

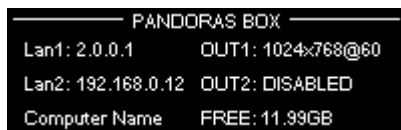

The status displays indicates:

The units IP address of the "Lan" adapter	Output1 Resolution
The units IP address of the "Lan2" adapter	Output2 Resolution
The units computer name	Free hard disc space

By pressing the encoder once you will enter the main menu.

#### Main Menu

From the main menu you may access several sub menus: Use the encoder to navigate through the menu entries and press the encoder to enter each of the sub menus. Press STATUS to return to the top level status menu.



## Lan1 & Lan2 - Network Menu

The network menu allows you to quickly change the unit's IP address and subnet mask settings as well as the DHCP enabled-setting of the unit.



Use the encoder to navigate through the network menu and turn the encoder to set the individual settings.  
 Please note that applying changes to the network setting may take several seconds until the unit is ready to proceed.  
 Press CANCEL to return to the main menu without changes.

## Output Menu

The output menu gives you a direct access to the available default resolutions.

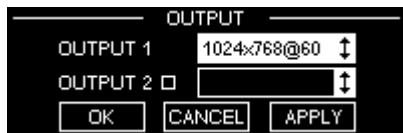

Use the encoder to navigate and choose from the list of display modes.  
 To enable Output2 please make sure that the check box next to Output2 is checked in order to setup both outputs.

Please note: The current version of Pandoras Box Server supports only matching resolutions on both outputs.

For more advanced resolution and refresh rate setups please use the onscreen menu to open the Output Nvidia Control Panel window.

Press CANCEL to return to the main menu without changes.

## Pattern Menu

When working offline (i.e. neither Pandoras Box Master or Client is running) you may assign test-patterns to the outputs.



Press MENU to return to the main menu, the last selected pattern will stay active until it is changed or rebooted.

## Playback Menu

The functions of the playback menu are enabled when Pandoras Box is in master mode in order to control the timeline. When working in master mode, the playback buttons are enabled as well.



- Press PLAY to run the timeline.
- Press STOP to reset the timeline to 00:00:00:00
- Press LAST to jump to the last cue available
- Press NEXT to jump to the next cue available
- Edit GOTO TIME lets you enter a specific timecode to jump to after you entered all value in hh:mm:ss:ff format
- Edit GOTO CUE lets you enter a specific cue number to jump to.
- Press MENU to return to the main menu.

### Mode Menu

The mode menu defines which version is loaded for the onscreen menu buttons. It also determines which master or client mode to choose if multiple revisions are installed on the unit.



In the top scroll list you may choose one of the installed revisions.

Choose the mode you want to start by clicking on either master or client.

To start a chosen mode, select START.

To close a running master or client, choose CLOSE.

Press MENU to return to the main menu.

### Display Menu

The display menu lets you setup both brightness and contrast of the LCD display.



Press MENU to return to the main menu

### Shutdown Menu

The Shutdown Menu lets you either shutdown or reboot the unit.



Press MENU to return to the main menu.

## 7.2 DVI AND SDI PROCESSOR

The DVI Processor and SDI Processor can be purchased as separate products. In the past they were shipped with the QUAD Players, QUAD Servers, Broadcast DUAL Servers, or Broadcast QUAD Servers.

### DVI Processor

The DVI Processor has two functionalities: on the one hand it splits the DVI signals coming from Pandoras Box hardware thus, it is possible to connect up to 4 monitors, projectors, other display devices via DVI. Please note that the DVI Processor can handle DVI-D signals only, any adaptation and conversion to analog signals like VGA or RGBHV is not supported! Many supported resolutions and timings accord to the international VESA standards. In addition, we included more 50Hz timings. Note that 75Hz and 85 Hz timings are not included but supported with custom EDIDs.

It is also possible to import custom EDIDs, defining not included resolutions and timings. DisplayIDs are supported as well; for the sake of simplicity this manual will use the term "EDID" meaning EDID as well as DisplayID.

**All connected devices must support the same EDID. It is not possible to set up different resolutions per output.**

On the other hand the DVI Processor converts the DVI signals coming from Pandoras Box hardware to SDI signals, wherewith SD-SDI, HD-SDI and 3G-SDI signals are supported. All supported SDI Timing EDIDs are standardized (EIA/CEA-861-D). The SDI signals accord to the specifications of SMPTE (274M, 296M, 125M, ITU-R BT.656).

The DVI Processor settings can be called via the [PB Menu](#)<sup>754</sup>, please find their description in the [software chapter](#)<sup>664</sup> whilst the [hardware](#)<sup>663</sup> is explained in detailed on the following page.

### SDI Processor

The SDI Processor converts the DVI signals coming from Pandoras Box hardware to SDI signals, wherewith SD-SDI, HD-SDI and 3G-SDI signals are supported. All supported SDI Timing EDIDs are standardized (EIA/CEA-861-D). The SDI signals accord to the specifications of SMPTE (274M, 296M, 125M, ITU-R BT.656).

Optionally, the SDI Processor splits each signal into two slices. Each output signal is duplicated, thus it possible to connect up to 8 monitors, projectors, other display devices via SDI.

**All connected devices must support the same EDID. It is not possible to set up different resolutions per output.**

The SDI Processor settings can be called via the [PB Menu](#)<sup>754</sup>, please find their description in the [software chapter](#)<sup>664</sup> whilst the [hardware](#)<sup>663</sup> is explained in detailed on the following page.

## 7.2.1 DVI AND SDI PROCESSOR HARDWARE

After dismantling please connect the DVI or SDI Processor to the power supply unit and plug the USB cable. The blue LEDs confirm the connected status.

We recommend establishing a network access via VNC. Depending on your display device it may scale the signal if it cannot display it properly, but it is possible as well that the display devices will stay black completely if you choose a resolution they do not support at all. Thus you will not see the desktop and the menu anymore.

The required driver for the DVI and SDI Processor is pre-installed. All drivers and their updates are free to download on the homepage's [Download-Center](#) after login.

Shut down the Player / Server. Do never hotplug the inputs into the DVI / SDI Processor as the graphic card driver might get damaged and needs to be reinstalled. Connect the DVI / SDI Processor's two inputs with the graphic card's outputs via the short DVI (dual link) cables provided. Please be sure, not to use other ones, especially longer cables in order to avoid signal noises or even breakdowns.

Connect the DVI Processor's outputs (either DVI or SDI) to your devices. Contrary to the inputs, the DVI Processor's outputs are hotplug-able.

Connect the SDI Processor's SDI outputs to your devices. Contrary to the inputs, the SDI Processor's outputs are hotplug-able.

Please make sure that the DVI / SDI Processor is powered before switching the Player / Server on.

All connected inputs and outputs are indicated by a blue LED. Red LEDs indicate that the signal is not passing through.

When choosing a different EDID all LEDs except the power and USB LED turn off, then according to your setting the input and output LEDs will change to magenta, red or blue once or twice. Please wait 5 seconds until the desktop background images are displayed properly and do not change anymore. If you choose different settings too fast, the graphic card driver might come into conflict. Then the two input LEDs will stay red no matter what EDID you choose. Please reboot the hardware.

LED Status of DVI Processor:



DVI input	red	inactive, no valid signal detected or input not connected
	blue	active, DVI single link signal detected
	magenta	active, DVI dual link signal detected
Sync status	off / blue	currently not used
DVI output	off	deactivated
	red	inactive, no valid signal
	blue	active, valid signal output
SDI output	off	deactivated
	red	inactive, no valid signal
	blue	active, valid signal output
USB / Power	off	deactivated, input not connected
	magenta	device is booting
	blue	active

LED Status of SDI Processor:



DVI input	red	inactive, no valid signal detected or input not connected
	blue	active, DVI single link signal detected
	magenta	active, DVI dual link signal detected
Sync status	off / blue	currently not used
SDI output	off	deactivated
	red	inactive, no valid signal
	blue	active, valid signal output
USB / Power	off	deactivated, input not connected
	magenta	device is booting
	blue	active

## 7.2.2 SOFTWARE - QUAD SETUP MENU

Before accessing the [DVI / SDI Processor's](#)<sup>662</sup> software settings, please connect it as explained in the previous [hardware chapter](#)<sup>663</sup>. Now, you may access the menu by clicking "Setup" > "Display Setup". If the DVI / SDI Processor is not connected properly the button opens the NVIDIA control panel. In that case please check that the USB cable and power supply are connected and that the USB driver is installed properly. Then press "Shutdown" > "Reset Menu".

With choosing the resolution and frame rate in the Quad Setup Menu, most of the changes and settings within the NVIDIA Control Panel have become obsolete. The only setting not influenced is the order of the primary and secondary screen. If you want to change it you may do so within the NVIDIA Control Panel as usual, as this does not influence the setting of the Quad Setup Menu.

In case the chosen timing does not seem right to you, we advise to have a look in the NVIDIA Control Panel, if the resolution is set to the native one for sure. The native resolution is now reported by the DVI / SDI Processor, not the display devices. In general, the driver is told to switch to the native resolution when the DVI / SDI Processor changes its timings. Please do not change any other resolution settings in the NVIDIA Control Panel as they will influence the DVI / SDI Processor's incoming signal but as the setting for the output ports are not changed, the displayed image will look as if it were cut off.

Thus the workflow is to take the resolution changes in the Quad Setup Menu only and to check in the NVIDIA Control Panel if the driver has switched to "native". Below, you find the available options for the DVI Processor's output configuration and at the end of this chapter the [SDI Processor's output options](#)<sup>670</sup>. The next chapter explains how to [create a new timing](#)<sup>672</sup> in case you like to complement the below output presets.



## Output Configuration for the DVI Processor

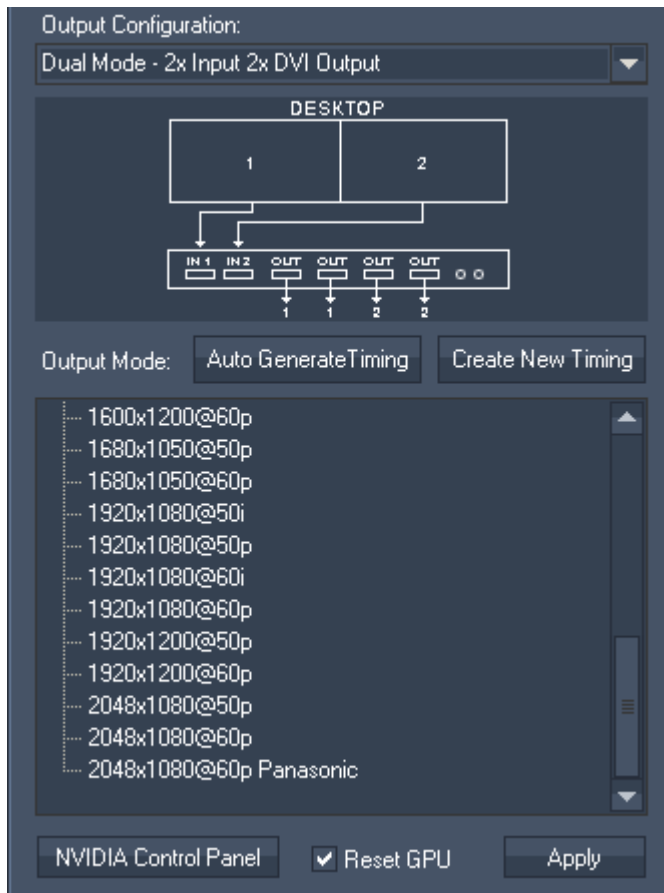

- Dual Mode – 2x Input 2x DVI Output

The primary Windows screen is distributed to DVI output 1 and 2. The secondary Windows screen is distributed to DVI output 3 and 4.

(The SDI outputs are inactive if the chosen EDID does not apply to one of the supported SDI specifications. If it does, the primary screen is passed to SDI output 1 additionally, as well as the secondary Windows screen is passed to SDI output 2.)

The button "Auto Generate Timing" generates a timing based on the information from the device plugged into DVI output 1. The timing is applied to DVI output 1-4 and the incoming signal is set accordingly.

The new timing is saved as an \*.edid file in the according sub folder under C:\system\LCD\_Menu\Quad DVI SDI Modes. It also appears in the according menu with a distinct name e.g. 1920x1080@50p custom AutoGenerated, so that you can select it later again.

The button "Create New timing" opens a dialog to define any custom resolution. The dialog is explained in the [next chapter](#)<sup>672</sup>.

With both options, "Auto Generate Timing" and "Create New Timing", you add a new EDID to the output presets. As you are in a "Dual Mode", the EDID will be assigned to the graphics card outputs one-to-one. This behavior differs to the one from the "Quad Modes".

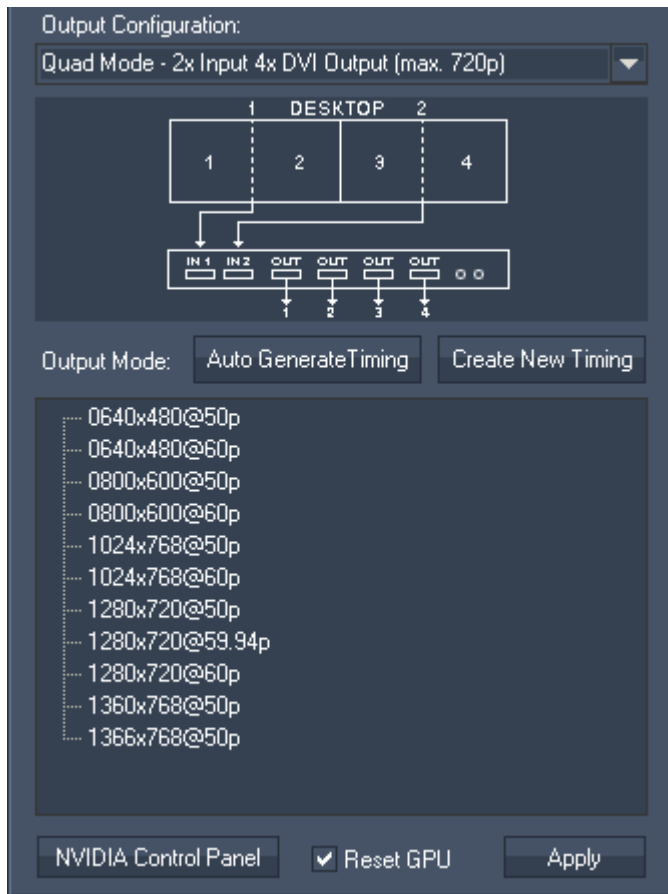

- Quad Mode – 2x Input 4x DVI Output (max 720p)

The left half of the primary Windows screen is shown on DVI output 1, the right half on DVI output 2. The left half of the secondary Windows screen is shown on DVI output 3, the right half on DVI output 4.

All resolutions and frame rates available are specified as single link DVI standard.

(The SDI outputs are inactive if the chosen EDID does not apply to one of the supported SDI specifications. If it does, the primary screen is passed to SDI output 1 additionally, as well as the secondary Windows screen is passed to SDI output 2.)

The button "Auto Generate Timing" generates a timing based on the information from the device plugged into DVI output 1. The timing is applied to DVI output 1-4 and the incoming signal is set accordingly.

The new timing is saved as an \*.edid file in the according sub folder under C:\system \LCD\_Menu\Quad DVI SDI Modes. It also appears in the according menu with a distinct name e.g. 1920x1080@50p custom AutoGenerated, so that you can select it later again.

The button "Create New timing" opens a dialog to define any custom resolution. The dialog is explained in the [next chapter](#)<sup>672</sup>.

With both options, "Auto Generate Timing" and "Create New Timing", you add a new EDID to the output presets. As you are in a "Quad Mode", the EDID will automatically be doubled to replace the resolution of the graphic card outputs. If this timing does not exceed a DVI Single Link timing, you will find it in the menu "Quad Mode – 2x Input 4x DVI Output (max. 720p), otherwise it will be added to the "...max.1080p / 2k).

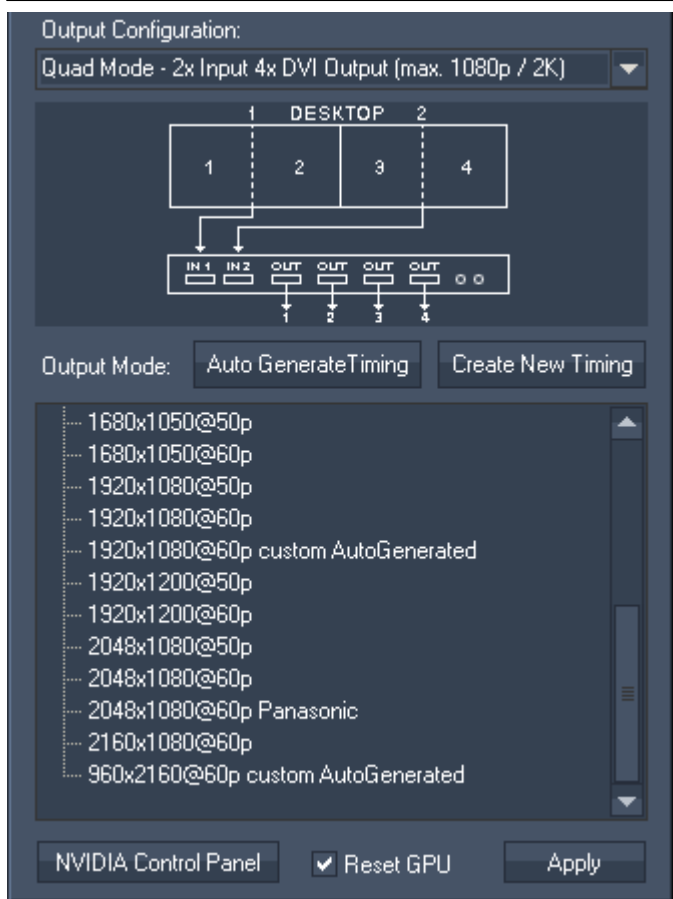

- Quad Mode – 2x Input 4x DVI Output (max 1080p / 2K)

The left half of the primary Windows screen is shown on DVI output 1, the right half on DVI output 2. The left half of the secondary Windows screen is shown on DVI output 3, the right half on DVI output 4.

All resolutions and frame rates available are specified as dual link DVI standard.

The SDI outputs are inactive.

The button "Auto Generate Timing" generates a timing based on the information from the device plugged into DVI output 1. The timing is applied to DVI output 1-4 and the incoming signal is set accordingly.

The new timing is saved as an \*.edid file in the according sub folder under C:\system\LCD\_Menu\Quad DVI SDI Modes. It also appears in the according menu with a distinct name e.g. 1920x1080@50p custom AutoGenerated, so that you can select it later again.

The button "Create New timing" opens a dialog to define any custom resolution. The dialog is explained in the [next chapter](#)<sup>672</sup>.

With both options, "Auto Generate Timing" and "Create New Timing", you add a new EDID to the output presets. As you are in a "Quad Mode", the EDID will automatically be doubled to replace the resolution of the graphic card outputs. If this timing does not exceed a DVI Single Link timing, you will find it in the menu "Quad Mode – 2x Input 4x DVI Output (max. 720p), otherwise it will be added to the "...max.1080p / 2k).

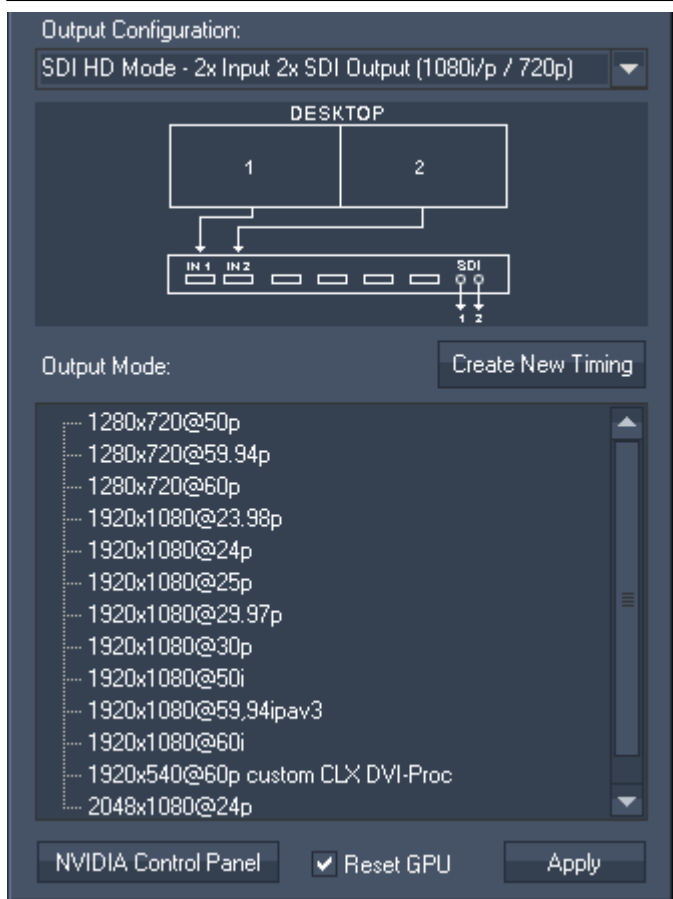

- SDI HD Mode – 2x Input 2x SDI Output (1080i/p / 720p)

The primary Windows screen is passed to SDI output 1, the secondary Windows screen to SDI output 2.

All resolutions and frame rates available are specified as HD-SDI standard.

The DVI outputs are inactive.

The button "Create New timing" opens a dialog to define any custom resolution. The dialog is explained in the [next chapter](#)<sup>672</sup>.

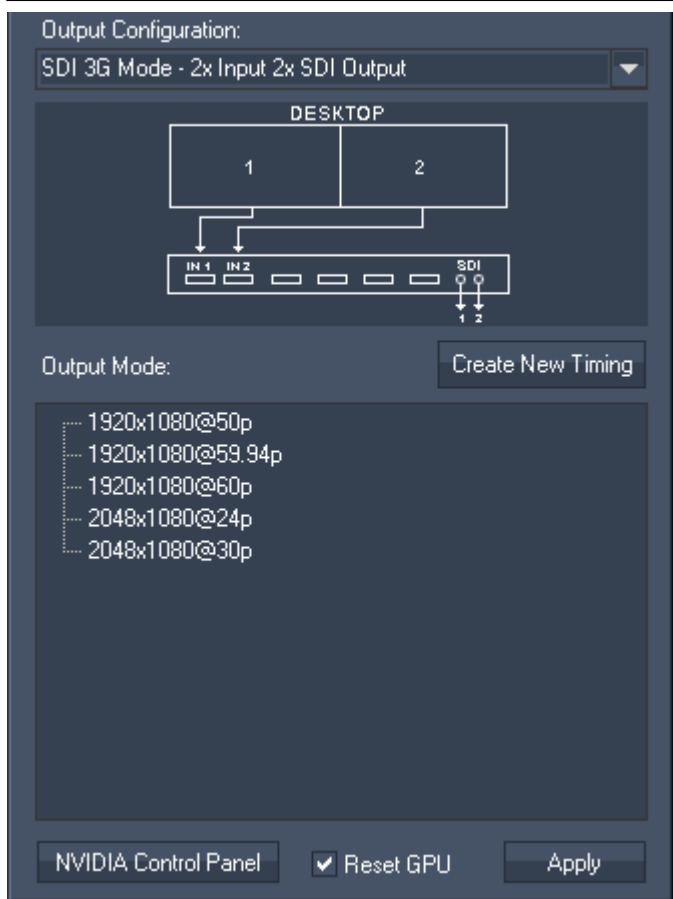

- SDI 3G Mode – 2x Input 2x SDI Output

The primary Windows screen is passed to SDI output 1, the secondary Windows screen to SDI output 2.

All resolutions and frame rates available are specified as 3G-SDI standard.

The DVI outputs are inactive.

The button "Create New timing" opens a dialog to define any custom resolution. The dialog is explained in the [next chapter](#)<sup>672</sup>.

### Output Configuration for the SDI Processor

Output Configuration:  
Quad HD Mode - 2x Input 4x SDI Output (1080i/p / 720p)

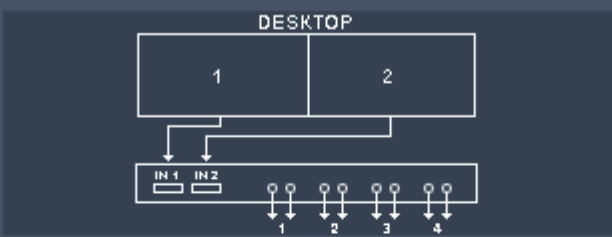

Output Mode:

- 1280x720@50p
- 1280x720@59.94p
- 1280x720@60p
- 1920x1080@23.98p
- 1920x1080@25p
- 1920x1080@30p
- 1920x1080@50i
- 1920x1080@59.94i
- 1920x1080@60i

NVIDIA Control Panel  Reset GPU Apply

- Quad HD Mode – 2x Input 4x SDI Output (max 1080i/p / 720p)

The left half of the primary Windows screen is shown on SDI output 1 and 2, the right half on SDI output 3 and 4. The left half of the secondary Windows screen is shown on SDI output 5 and 6, the right half on SDI output 7 and 8.

All resolutions and frame rates available are specified as HD-SDI standard.

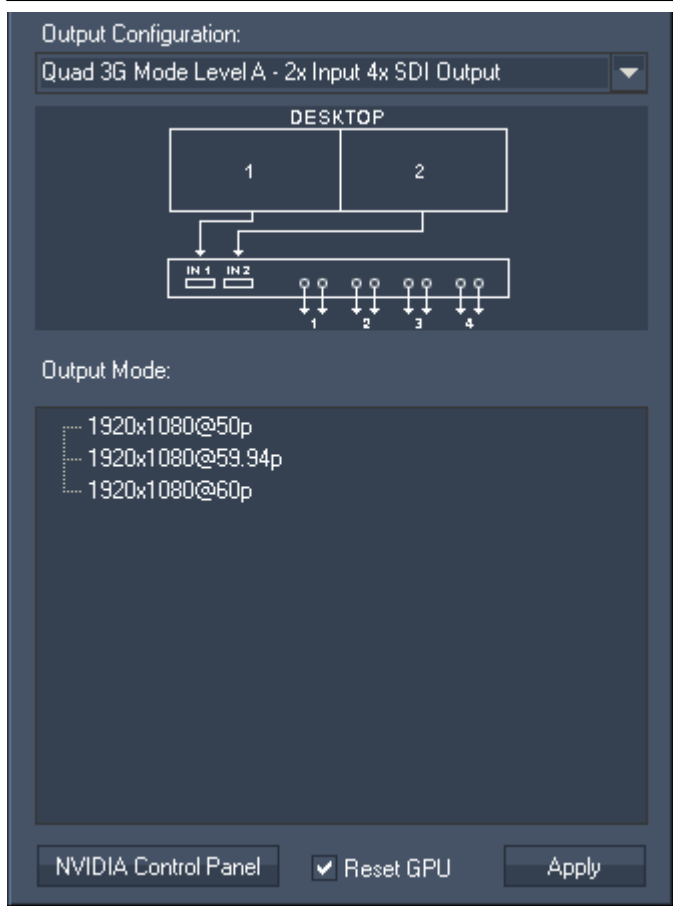

- Quad 3G Mode Level A – 2x Input 4x SDI Output

The left half of the primary Windows screen is shown on SDI output 1 and 2, the right half on SDI output 3 and 4. The left half of the secondary Windows screen is shown on SDI output 5 and 6, the right half on SDI output 7 and 8.

All resolutions and frame rates available are specified as 3G-SDI standard.

## 7.2.3 SOFTWARE - CREATE NEW TIMING

This chapter explains the dialog "Create New timing" that can be called from within the [configuration menus](#)<sup>664</sup> from the [DVI Processor](#)<sup>662</sup>. Please note that the term "EDID" means EDID as well as DisplayID.

The dialog offers settings to define a custom timing, which includes the settings to...:

- create an entirely new EDID
- read out a display's EDID or load it from a file
- modify EDIDs
- save new EDIDs to a file and generate a preset for the DVI Processor's output configuration menus.



### Name

You can name your timing optionally. In case the timing is displayed as an preset in the output configuration menus, the name appears at the end of the entry, e.g. 1920x1080@50p custom "name". In addition, the name is also mentioned in the NVIDIA control panel as it is part of the EDID Descriptor Block.

### Load File

Use "Load File ..." to load a stored EDID into the dialog. You can edit the timing, generate an output preset or save it as an \*.edid file.

### Save File

Use "Save File ..." to export the currently displayed EDID timing into a \*.edid file.



**Read Output 1...4**

These buttons generate a timing based on the information from the device plugged into the according DVI output. Note that SDI outputs can not be read-out. The timing is displayed in the dialog. Note that all values will equal zero if no valid EDID can be read. You can edit the timing, generate an output preset or save it as an \*.edid file.

**Generate & Exit**

This option generates an output preset based on the currently displayed timing and closes the dialog.

Please note, that it is of importance from which menu you opened the dialog. If you were in the DVI "Dual Mode" (2in 2out), your EDID is assigned to the graphics card outputs one-to-one. In case you were in a DVI "Quad Modes" (2in 4out, either Single Link with max. 720p or Dual Link with max.2k), your EDID is automatically doubled as the graphic card outputs are split in the Quad Modes. In both cases the displayed timing in this dialog and the entry in the menus always refer to the Processor's outputs.

The new EDID is saved as an \*.edid file in the according sub folder under C:\system\LCD\_Menu \Quad DVI SDI Modes. It also appears in the according menu with a distinct name e.g. 1920x1080@50p custom (optional name). Go to the DVI Processor's output configuration menu and select it to apply it to DVI output 1-4 whilst the incoming signal is set automatically.

**Cancel**

Use "Cancel" to close the dialog and discard all settings.

**EDID Description**

The EDID Description shows the content of the "First Detailed Timing Descriptor Block" along with the "Monitor Name" out of the EDIDs "Descriptor Block 2".

The displayed information changes automatically when "Load File" or "Read Output 1...4" is used. You can edit the timing, generate an output preset or save it as an \*.edid file as described above.

**Detailed Timing**

Name	Read out or change the monitor name with a maximum of 13 characters.
PixelClock	This value shows the signal's PixelClock in MHz. The maximum value is 330.
Rate Hz	This value shows the signal's Refresh Rate in Hz when an EDID is loaded. It results of all other definable settings regarding pixel count and PixelClock.
Res X	This value shows the signal's active pixel per horizontal line. Active pixels are the shown ones within a display device and equal the horizontal resolution. The maximum value is 4095.
Res Y	This value shows the signal's active lines per image. Active lines are the shown ones within a display device and equal the vertical resolution. The maximum value is 4095.
Blank X	This value shows the signal's total horizontal blanking pixels including (definable) front porch, (definable) sync width and (resulting) back porch. The combination of the horizontal active, blanking and border pixels equals the picture's horizontal total pixels. The maximum value is 4095.
Blank Y	This value shows the signal's total vertical blanking lines including (definable) front porch, (definable) sync width and (resulting) back porch. The combination of the vertical active, blanking and border lines equals the picture's vertical total lines. The maximum value is 4095.
H Sync Off	This value shows the signal's horizontal sync offset (front porch) in pixels. The maximum value is 1023.

V Sync Off	This value shows the signal's vertical sync offset (front porch) in lines. The maximum value is 1023.
H Sync Width	This value shows the signal's horizontal sync width in pixels. The maximum value is 1023.
V Sync Width	This value shows the signal's vertical sync width in lines. The maximum value is 1023.
H Img Size	This value shows the monitor's horizontal image size in mm. This information value is optional and has no influence on the signal processing. The maximum value is 4095.
V Img Size	This value shows the monitor's vertical image size in mm. This information value is optional and has no influence on the signal processing. The maximum value is 4095.
H Border	This value shows the signal's horizontal border in pixels. The maximum value is 255.
V Border	This value shows the signal's vertical border in lines. The maximum value is 255.
Interlaced	This check box shows if the signal is interlaced (checked) or progressive (unchecked).

**Sync Signal**

Readout or select the desired sync option required by the signal.  
Depending on the chosen sync option, there are additional check boxes to be de-/activated.

**Stereo Mode**

Readout or select the desired Stereo Mode required by the signal.

## 7.3 GRAPHICS CARD SETTINGS

All Pandoras Box hardware (Server, Player and Manager) is equipped with NVIDIA graphics cards.

The NVIDIA Control Panel allows to change the current output settings, e.g. the resolution or the way multiple displays should be addressed.

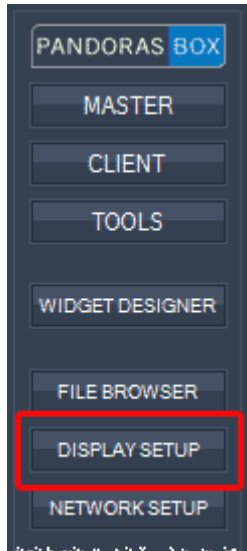

With Pandoras Box Dual Servers or Players you will be able to open the NVIDIA Control Panel via the "Display Setup" button of the [PB Menu](#)<sup>754</sup> to manually set resolutions and display settings.

However, with a connected DVI Processor (e.g. Pandoras Box Quad Servers or Players) this button opens another dialog which includes an "NVIDIA Control Panel" button in the bottom left corner. For detailed information for handling the [DVI Processor](#)<sup>662</sup> please see its chapter.

In case you are working with a Server that is equipped with a [LCD Menu](#)<sup>659</sup>, you may access basic resolution settings through the front panel i.e. without the NVIDIA Control Panel.

Please see the following topics:

- [Changing the resolution](#)<sup>675</sup>
- [Setting up multiple displays](#)<sup>677</sup> (horizontal span and Dualview)
- [Setting up the frame lock option](#)<sup>678</sup>
- [Installing and setting the graphics driver](#)<sup>682</sup>
- [ATI cards](#)<sup>685</sup> (discontinued)

**Do not disconnect any VGA or DVI display cable from the graphics card during runtime!  
When changing display cables directly on the graphics card, coolux recommends to always shut down the system first!**

**In addition it is required to close the Pandoras Box client or master software BEFORE modifying the display setting.  
Restart Pandoras Box software after applying changes regarding the resolution or display mode.**

### 7.3.1 CHANGING THE RESOLUTION

This topic explains how to change a resolution with the [NVIDIA Control Panel](#)<sup>675</sup>. The next topic describes the setup of [multiple displays](#)<sup>677</sup>, [synchronization](#)<sup>678</sup> and [driver update](#)<sup>682</sup>.

In the NVIDIA Control Panel you may choose from any of the reported display resolutions by selecting the "Change resolution" menu in the task tree on the left of the control panel. To change the resolution of a specific display, click on the monitor icon and then select one of the available resolutions below to set the desired resolution for the selected output.

Please remember to close the Pandoras Box client or master software before clicking "Apply" to modify the display setting.

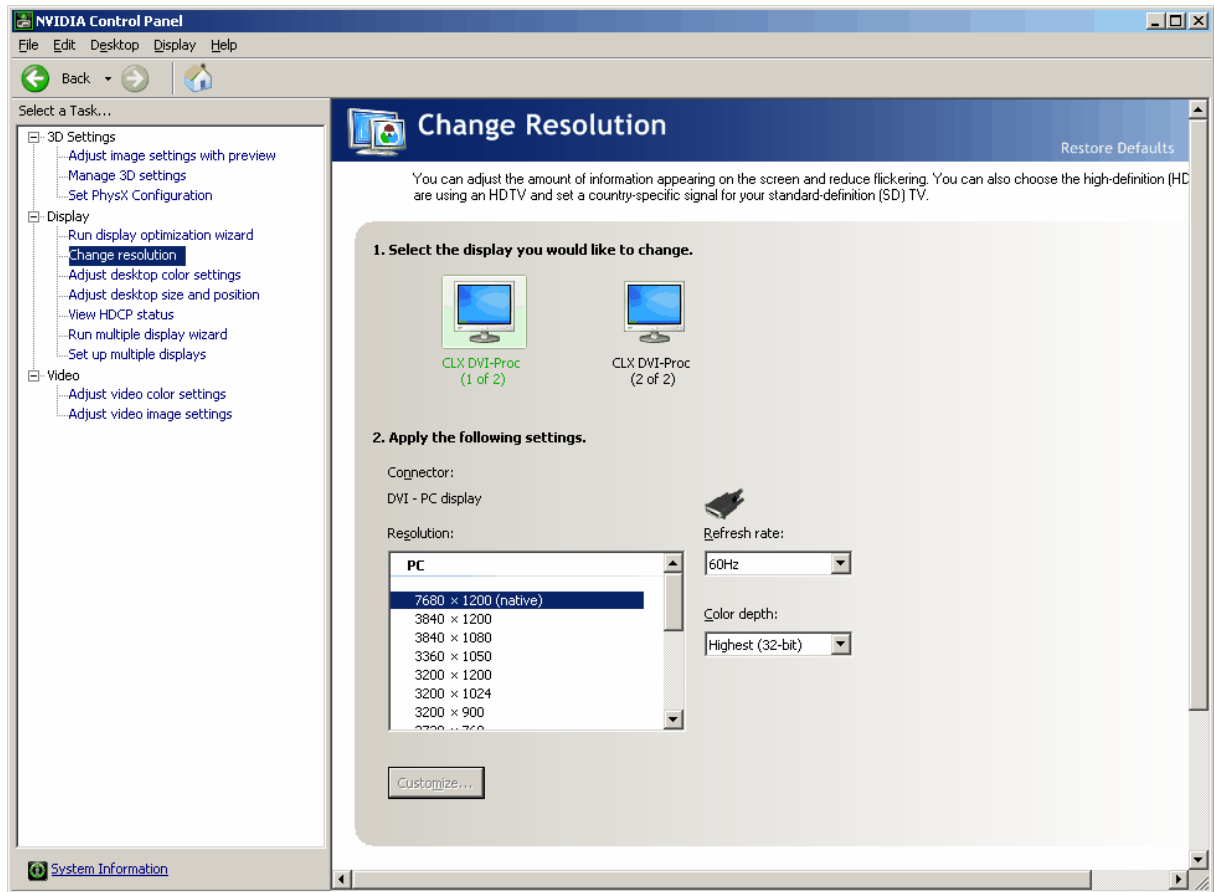

If the desired resolution is not listed in the change resolution menu, you may click the "Customize" button below the list of available resolutions to set up custom timings and refresh rates that are supported by your display. For more detailed timing settings please use the "Advanced>>" menu.

Please be aware that changing your graphics card to unsupported resolutions and frequencies might damage your display and graphics card. coolux can not be held liable for any damages that may occur from these custom setups. Instead of creating custom timings, coolux recommends to use EDID managers to force the graphics card into the resolution you need.

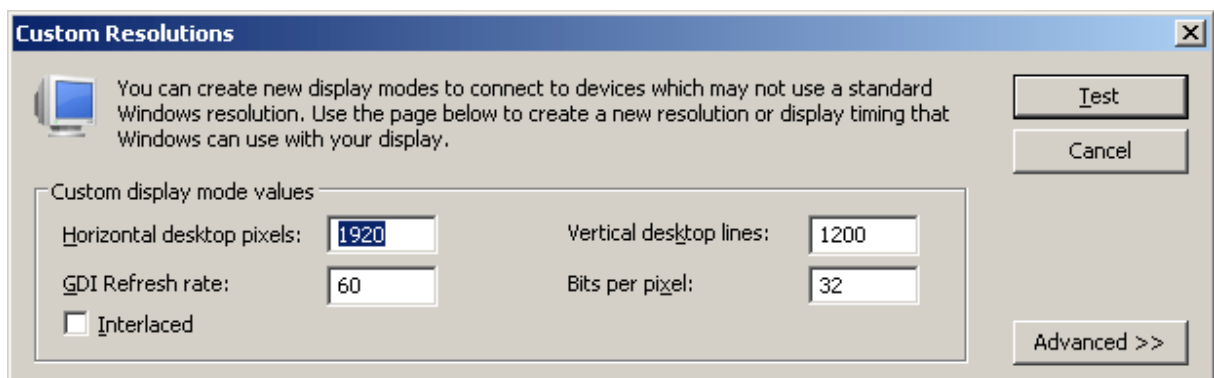

### 7.3.2 MULTIPLE DISPLAYS

This topic explains how to setup multiple displays with the [NVIDIA Control Panel](#)<sup>675</sup>. The previous topic describes how to [change a resolution](#)<sup>675</sup>, the next ones how to [frame lock displays](#)<sup>678</sup> and [update the graphics driver](#)<sup>682</sup>.

#### Setting up multiple displays in "Horizontal span"

If your Server or Player runs as a master or client and is connected with multiple displays and you need to render full screen on all displays, it is recommended to use the mode "As one large horizontal desktop (Horizontal span)". This ensures best video rendering and (synchronous) playback performance. In case you are using a master system, please note that it is not possible to see the user interface any more.

This mode will also force the graphics card to use the same resolution on both outputs. It is not possible to use different resolutions or frequencies!

If you like to swap the order of the two displays you may open the drop-down list as highlighted in the image and choose another entry.

Please remember to close the Pandoras Box client or master software before clicking "Apply" to modify the display setting.

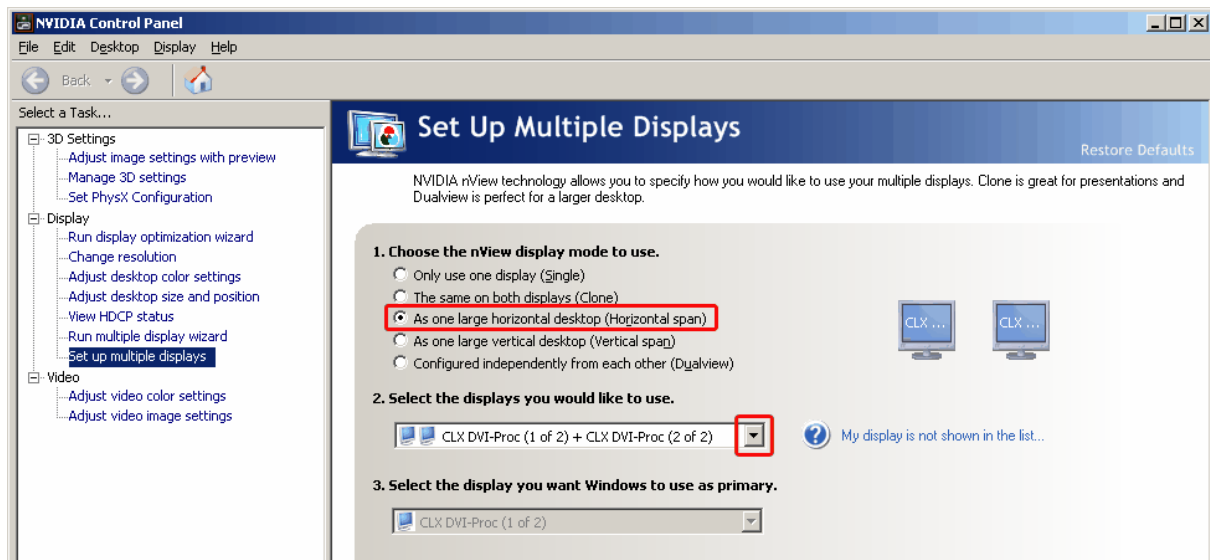

#### Setting up multiple displays in "Dualview"

If your Server, Player or manager runs as a master and is connected with multiple displays and you wish to see the user interface at the same time as a full screen preview, it is recommended to use the mode "Dualview". This enables two independently configurable outputs, a so called primary screen and a secondary screen. The preview tab in Pandoras Box can only be rendered on the primary screen. You may change the order by choosing another entry in the according drop-down list.

Please note that since version 5.7 Pandoras Box supports different resolution and frequency on outputs.

To run Pandoras Box in master mode with this setup above you also have to enable an option in the [Configuration tab](#)<sup>139</sup> section [Render Engine](#)<sup>153</sup>. The check box "Fullscreen is single" will allow to decide which output toggles into fullscreen and which one does not in order to view the user interface at any time.

### 7.3.3 SETTING UP FRAME LOCK

This topic explains how to setup the frame lock option for frame and pixel line accurate synchronization. Please refer to the main chapter if you are interested in other [NVIDIA settings](#)<sup>675</sup> e.g. settings for resolution, multiple displays and the driver.

#### General information regarding frame lock

The frame lock option is for NVIDIA cards with a sync board, e.g the K5000. These graphics cards have the possibility to synchronize the output to an external frame lock signal. They are per default available for Broadcast Servers, but are optional for all other Servers too.

In order to input the sync signal, plug the BNC cable into the sync board located next to the graphics card. Make sure that the sync signal fits to the resolution and frame rate that is set up in the graphics card for the displays attached.

Then the below described driver settings are necessary to set up the graphics card. It will then clock to the incoming signal. This procedure might take up to 10 minutes as the card's clock needs to shift step by step towards the external clock.

To synchronize the graphics clock to the external clock directly, has the advantage of saving latency. The not-direct way would be to not set up the frame lock option in the Server but to input the Server's output into another frame lock device which then locks the image to the external clock, e.g a Frame Buffer or Frame Synchronizer. This workflow causes a latency of one frame.

In no scenario it is currently possible to frame lock the live input of Pandoras Box. If you need frame locked inputs, you need to feed the sync signal to the device that produced the live feeds and make sure that the live inputs are fed frame locked into Pandoras Box.

#### Setting up the frame lock option for one system

To set the frame lock option, open the NVIDIA Control Panel as described in the [first chapter](#)<sup>675</sup>.

The first step is to set up the outputs in the so-called Dualview:

- go to "Display > Set up multiple displays"
- under "1", choose Dualview
- under "2", open the drop-down and make sure the depicted setting is chosen "Output (1 of 2) + Output (2 of 2). In most cases you probably have the DVI Processor attached to the Server, hence one output is called "CLX DVI-Proc"
- under "3", choose "Output (1 of 2)" as the primary display
- "Apply" the settings

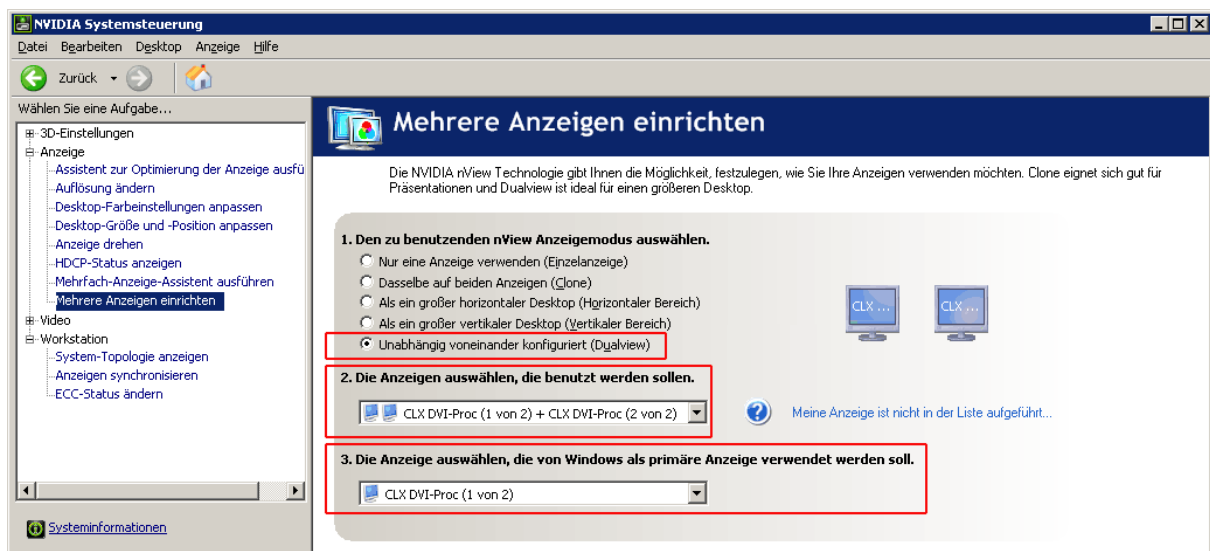

Check the resolution and framerate as described in the chapter "[Changing the resolution](#)"<sup>675</sup>.

The second step is then to set up that the first output listens to the external clock but the second output to the first one, in other words, to the internal clock:

- go to "Workstation > Synchronize displays"
- under "1", click the second option "Onto this system"
- highlight the "Output (1 of 2)" and
- under "2", make sure that the check box is ticked to synchronize "Output (2 of 2)" to the first output
- "Apply" the settings.

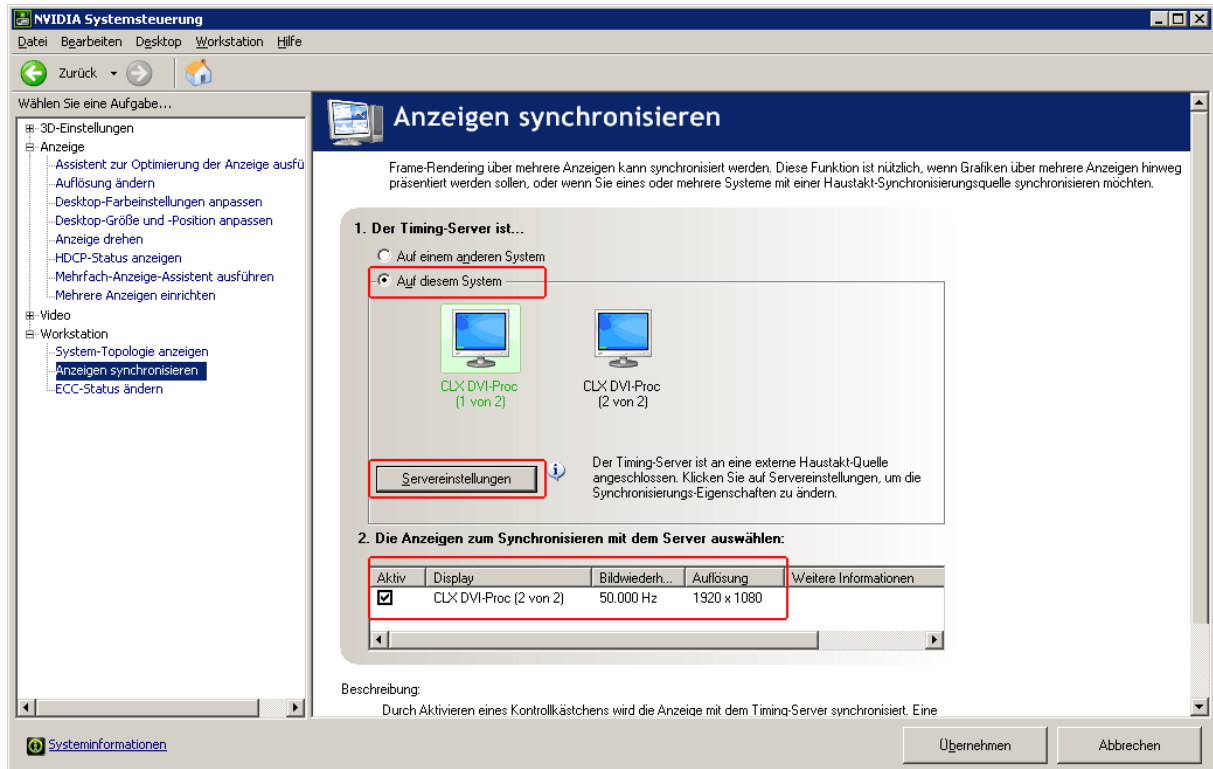

Third step: In the "Synchronize displays" window, click the button "Server Settings" to set the properties of the frame synchronization pulses generated by the timing server:

- choose the setting "An external house sync signal" as the basis for the synchronization pulses
- make sure that the sync frequency matches with the frame rate
- only if needed, change the drop-down list for the sync signal detection and tick the check box whether the "signal is interlaced"
- choose how the sync pulses from the frame start signal should be triggered: leading -, falling -or both edges
- in most cases the outgoing sync interval is 0
- set the correct Sync delay, then "Apply" the settings to verify their correctness

In the depicted example, the sync delay is 300µs, but this number depends on your setup and the current graphics card clock. It is likely you will have to try out different delays. As experienced, it is mostly 300-500µs, you may start with 300µs and increase in 50µs steps if it was not correct. Mind that it takes the system up to 10 minutes to reach the set clock.

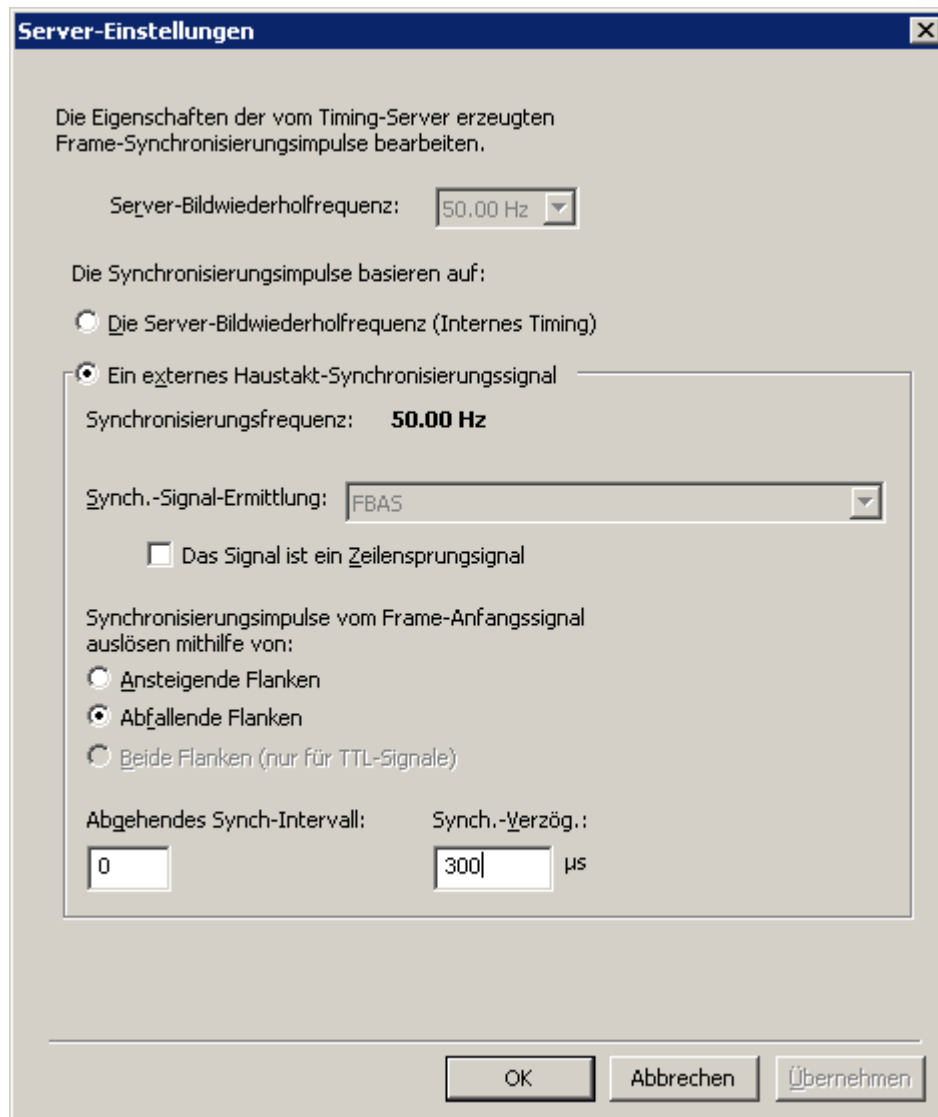

Forth step: You may check in "Workstation > View system topology" whether all settings are correct:

- the external sync signal should be present and in use
- the frame lock sync pulse should be present
- the first DVI should be listed with "Output (1 of 2)", the second with "Output (2 of 2)"
- the first output's display state should be "Server" and its timing depends on the external house sync signal
- the second output's display state should be "Client" and its timing depends on the internal frame lock sync pulses



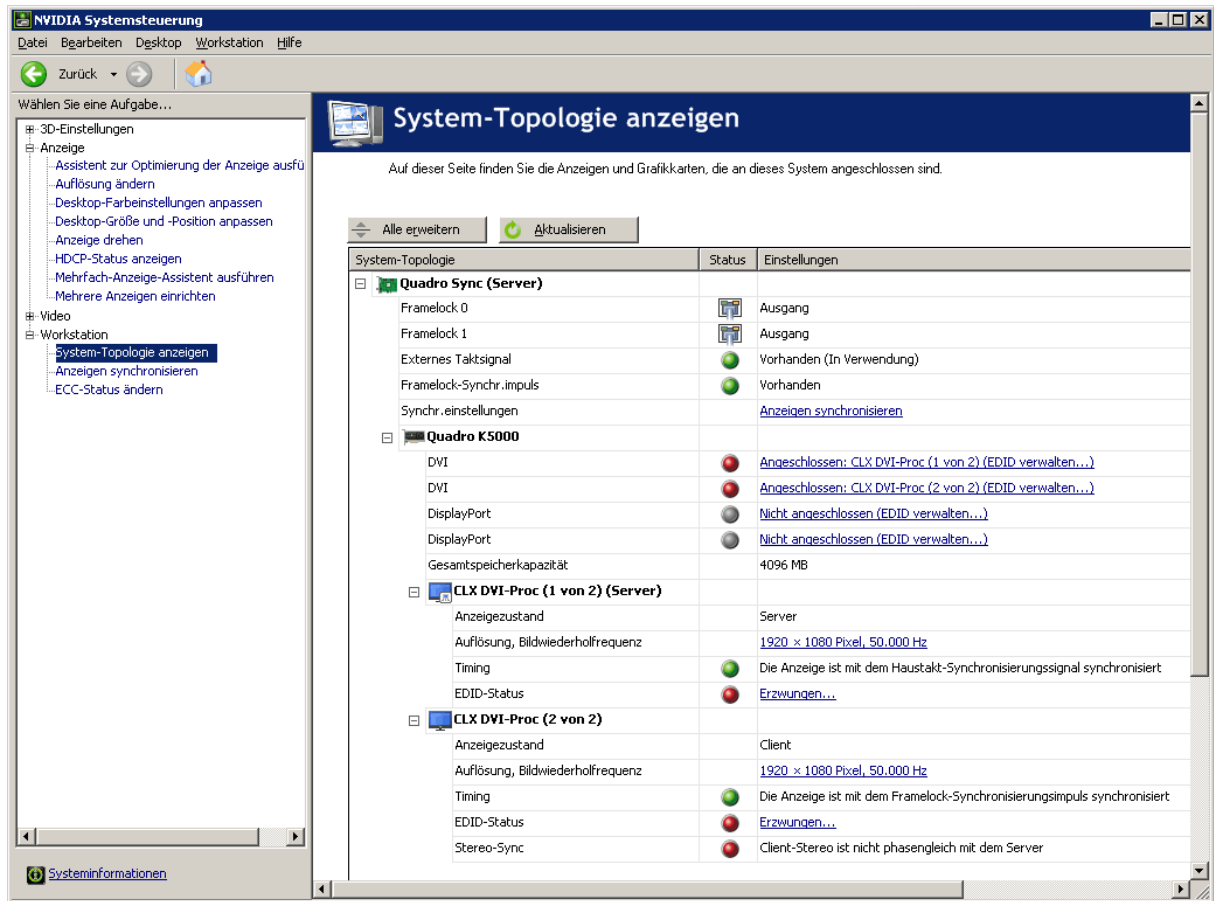

### Setting up the frame lock option for one stand-alone system

This describes, how to set up the frame lock for one machine that needs to frame lock its both outputs, but does not receive an external timing. This might be needed when you need to frame lock both (or the four) outputs 100%, e.g. if you pass the output signal to a 4K screen / projector that does not include a frame buffer and needs to have frame locked input signals.

No cables are connected to the sync board.

The above settings regarding the first step to set up DualView, apply as well. Nothing changes in the second step either, in "Workstation > Synchronize displays" under "Onto this system", synchronize the second output onto the first one.

Nothing must be set up in the dialog "Server settings".

In "Workstation > View system topology" the timing for the first output says "Synchronized to an internal timing", the second stays on the internal frame lock sync pulses.

### Setting up the frame lock option for several systems

If you have more than one machine that need to be frame locked, one machine is the so-called "Master" whilst the others are "Slaves".

The master is set up as described above, either with the external sync or with the internal one if you only want to synchronize the Pandoras Box playback systems to each other. The master provides an external sync signal via the RJ-45 plug on its synchronization board. Connect the board's output with an ethernet cable to the input of the next Server, which is then the slave. You may daisy-chain the sync signal in this way to all slaves.

In "Workstation > View system topology"

For the slaves, the above settings regarding the DualView step, apply to the slave as well. As a second step, do not choose "Onto this system" but "Onto another System", this applies for the first and second output. In other words, tick both check boxes.

In "Workstation > View system topology" the lines "Framelock..." have changed as you now use the ethernet plugs: "Framelock 0" and "Framelock 1" should automatically change to "Input" or "Output". The timing for the first output says "Synchronized to an internal timing", the second stays on the internal frame lock sync pulses.

### 7.3.4 GRAPHICS DRIVER

This topic explains how to install and setup a new graphics driver and how to check your current driver version. Please refer to the main chapter if you are interested in other [NVIDIA settings](#)<sup>675</sup>.

#### Installing a graphics driver

The graphics card driver on your coolux hardware product is tested and certified by us for best video rendering and playback performance. Even if the installed driver might not be the newest one available from the NVIDIA website it is NOT recommended to update this driver to their latest one.

If it's necessary or you were told by our support team to reinstall or update the graphics card driver please follow these steps:

- 1) Download the driver according to your hardware version. Please refer to the [coolux Download Center](#) for recommended driver versions.
- 2) Run the driver setup in user custom (advanced) mode.
- 3) Deselect the options for NVIDIA update and nView but select the option for "Perform a clean installation"
- 4) After the installation is finished please reboot the computer, also if it does not do it automatically
- 5) After the reboot go to the NVIDIA Control Panel, section "Manage 3D settings" and change the following options to match the coolux defaults:
  - Antialiasing – Gamma correction = OFF
  - Maximum pre-rendered frames = 1
  - Texturing filtering = High Quality
  - Vertical Sync = Force ON

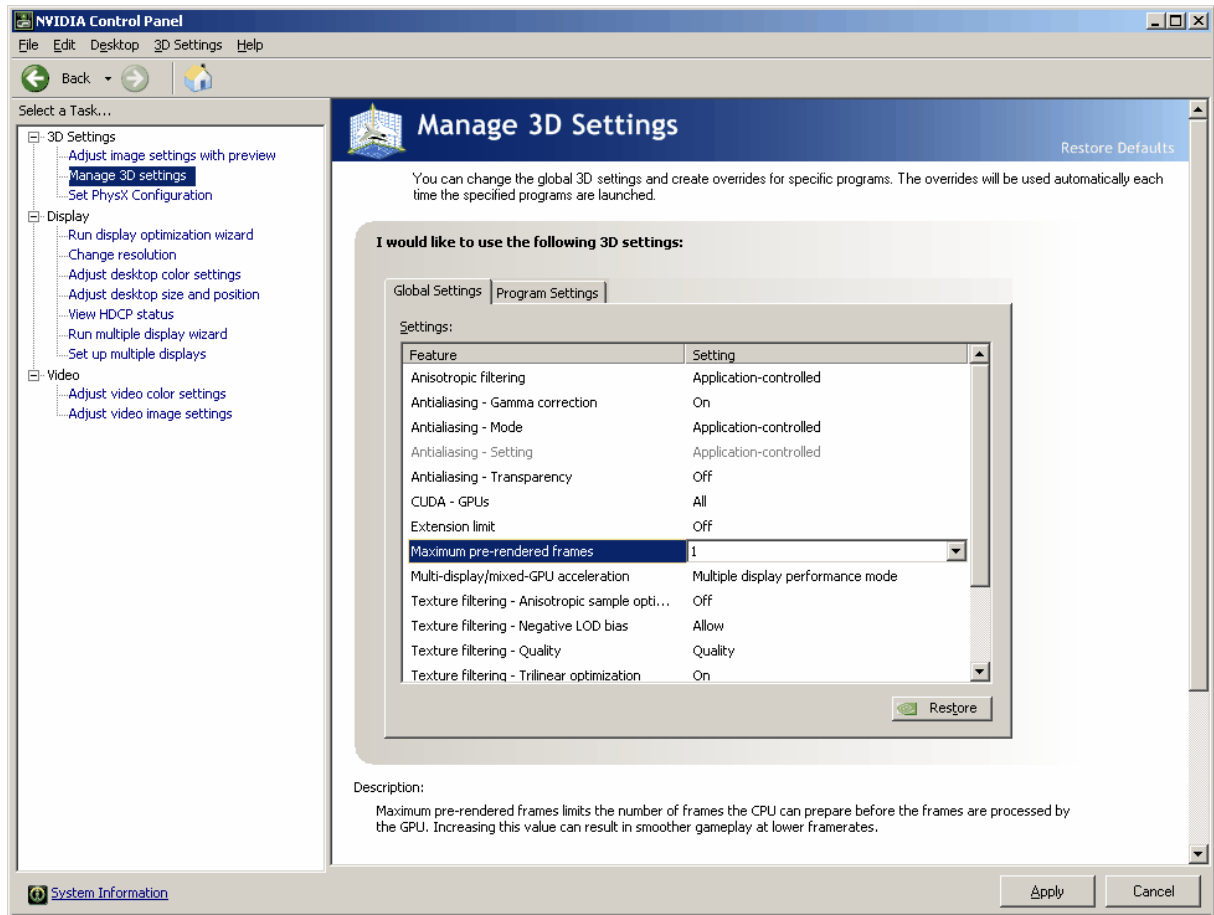

### Checking the current driver version

You can always see which graphics card model and driver version is installed in your coolux hardware by clicking on the "System Information" button on the bottom left corner of the NVIDIA Control Panel.

In the upcoming window you can see the graphics card model on the left and the driver version in the first line on the right part of the window.

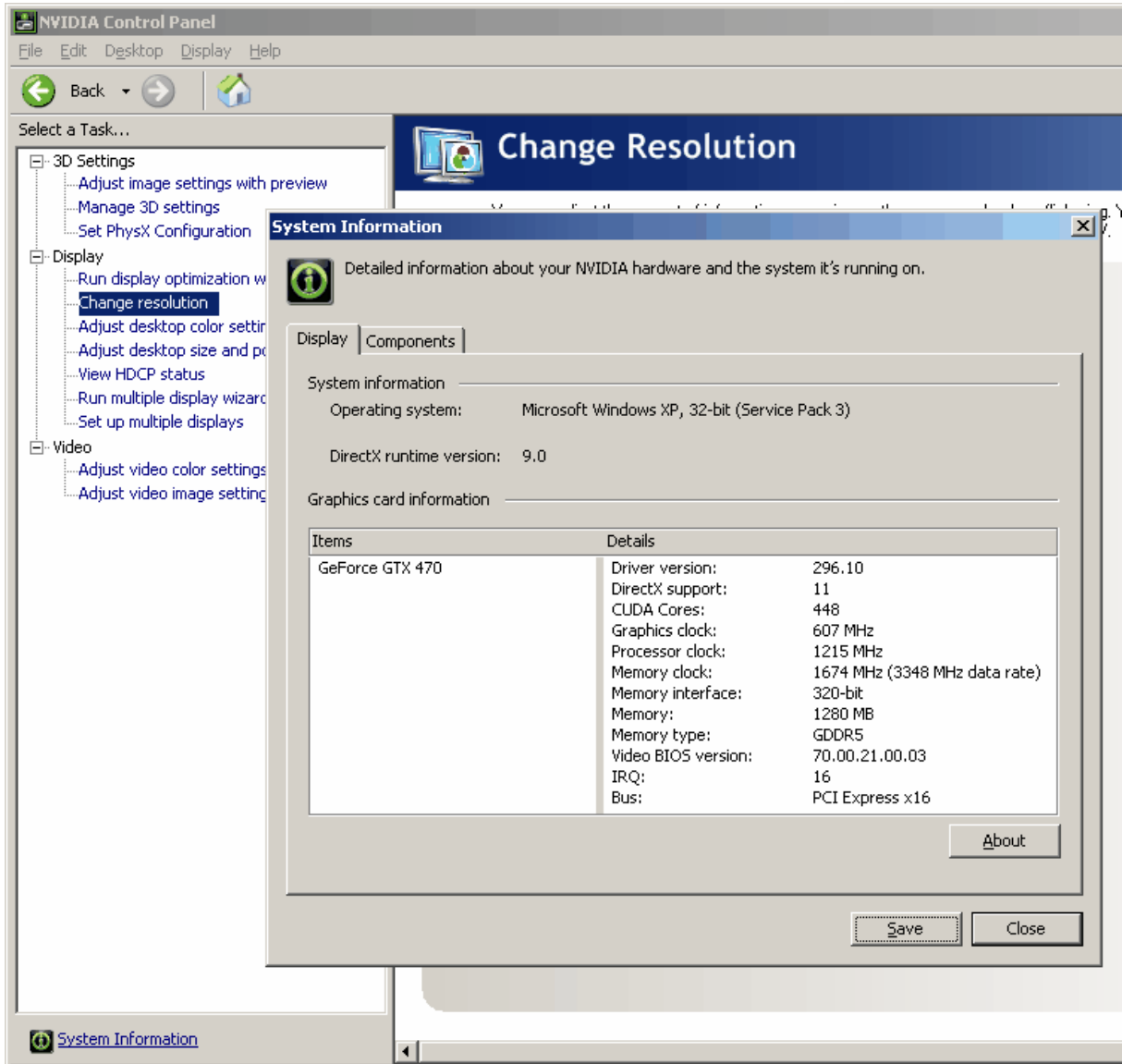

### 7.3.5 ATI CARDS

This topic explains how to apply display settings for ATI graphics card. Please note that Pandoras Box hardware is now equipped with [nVidia cards](#)<sup>675</sup>. Only Rev3-hardware was equipped with ATI X1800 / X1900 cards. However, this topic might also be of interest for users who run Pandoras Box on their own hardware that is equipped with an ATI card. In that case please note that the below menus description and images might change according to the used driver.

The ATI graphics card allows several output configurations based on the alignments you make in the display settings. ATI supplies the Catalyst Control Center for detailed display setup.



To configure the graphics card's outputs, please setup your display configuration and resolution in the display manager.

In case that you have a system with an earlier card than the ATI X1800, please contact coolux for an upgrade or hardware trade-in of the system.

Pandoras Box Server Output Resolutions with ATI X1800 / X1900 Cards

SingleOutput DVI / RGBHV

640x480	VGA
800x600	SVGA
1024x768	XGA
1280x720	HD 720p
1280x1024	SXGA
1400x1050	SXGA+
1600x1200	UXGA
1920x1080	HD 1080p
2048x1536	SUXGA

DualOutput DVI / RGBHV

1280x480	2x VGA
1600x600	2x SVGA
2048x768	2x XGA
2560x1024	2x SXGA
3200x1200	2x UXGA

Refresh Rates 50\*, 60 or 75hz

\*50hz Modes can be set via the EDID of the attached display.

Please note:

not all displays allow specific EDID settings, please use an EDID manager or a comparable device to set custom frequencies.

S-Video (Pal/Ntsc) – Output thru the onboard S-Video and Composite connector

Please note:

when using display devices that support EDID (Extended display identification data) via DVI, please reboot the Server in order to get the EDID information and settings in the Catalyst Control Center

After changing these settings, please restart the Pandoras Box Server application to apply the changed settings of the graphics card.

SINGLE OUTPUT MODE

Once your system is connected to a single display, it is by default set to single output mode. If you want to add or change the display configuration, please shut down all Pandoras Box applications before making any changes.

DUAL OUTPUT MODE



When a new display is connected to the graphics card, it will be shown in the “Attached displays currently disabled” section.

Right-Click on the disabled display and choose “Stretch Main horizontally onto digital panel”



Once the display settings are changed, you will have to confirm these changes, otherwise the graphics card will reset to the previous settings.





Once confirmed, you may adjust the overall desktop area resolution, colour quality and refresh rate.



Please note: The driver allows only specific resolutions in dual output mode.

SINGLE FULLSCREEN MODE

If you want to use Pandoras Box in single fullscreen mode in order to display the user interface on the secondary monitor, please set the secondary output to “Extend Main horizontally onto digital panel”



When using the extended display mode, Pandoras Box will only be rendering on the primary output, while the user interface can be operated on the secondary output.

CLONE MODE

If both outputs should be set up to always emit the same content, the output can be set up to be cloned. Simply choose the right click option "Clone Main with digital panel"



7.4 INPUT CARD SETTINGS

You may have various different live input cards or software screen grabbers available within your system.

Please note that Pandoras Box supports only input devices that are conform and support DirectShow.

Depending on the installed component, the according driver window will show up and let you set up the available parameters of the input device.

- [Datapath Vision RGB Pro<sup>693</sup>](#) (VGA Capture Card) - discontinued
- [Winnov Videum 4400<sup>695</sup>](#) (4xComposite Capture Card) - discontinued
- [Decklink Video Capture Card<sup>703</sup>](#) (SDI) - discontinued

[Coolux SD SDI](#)<sup>704</sup>

[Coolux HD SDI](#)<sup>705</sup>

[Coolux Dual DVI Capture Card](#)<sup>707</sup>

If you like to use a live input from a client within a master-client-setup:

- start the [client](#)<sup>294</sup> first
- then go to the master, [Asset tab](#)<sup>137</sup> > your client > folder "Direct Show" > folder "Live Inputs"
- drag the according card into the [Project tab](#)<sup>248</sup>; this initializes the card
- now you may configure the card; you can do this in the Master or in the Client window
- Master: mark your Input Device in the Project tab to see its properties in the Inspector, then select it in the file table and click the "Configure" button
- Client: click on the button "Configure Live Inputs" and choose the one that you want to configure from the live input list

If you like to use a live input within a stand-alone setup:

- start the master
- then go to the [Asset tab](#)<sup>137</sup> > local > folder "Direct Show" > folder "Live Inputs"
- drag the according card into the [Project tab](#)<sup>248</sup>; this initializes the card
- now you may configure the card: mark your Input Device in the Project tab to see its properties in the Inspector, then select it in the file table and click the "Configure" button

#### 7.4.1 DATAPATH VISION RGB PRO (VGA) - discontinued

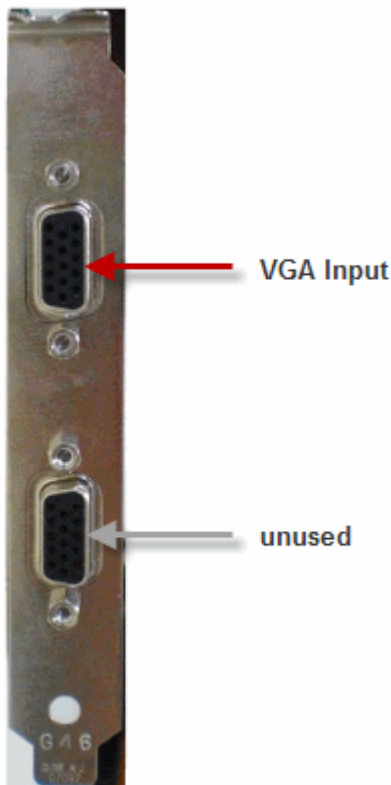

#### Configuration

Please note:

Make sure to always use the up-to-date driver from our homepage. Visit our user forum [www.coolux.de/kb](http://www.coolux.de/kb), you will find all input card drivers under Downloads - Drivers - Input Card drivers. A short registration is required.

To configure the VGA Capture Card, please click on [Configure Live Inputs] and choose your VGA Capture Card from the live input list (Client Mode) or mark your Input Device in the Project Tab and click on [Configure] in the Inspector Tab (Master Mode).

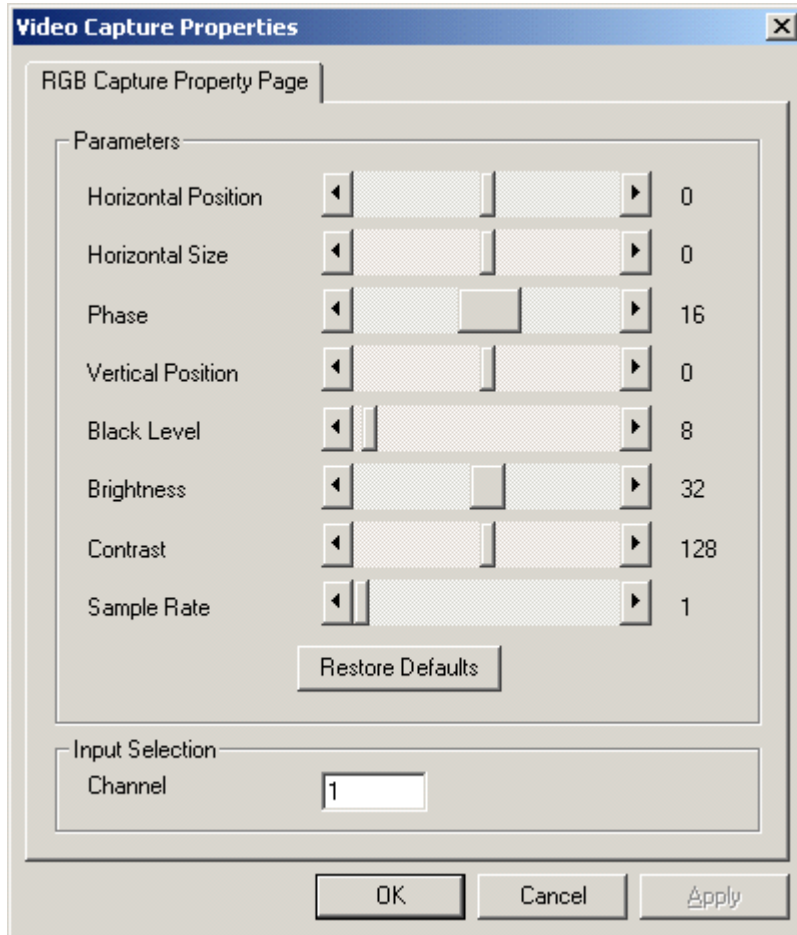

In this window please choose the values for Horizontal Position and Size, Phase, Vertical Position, Black Level, Brightness, Contrast and Sample Rate, or Restore Defaults by pressing the button. Please also choose the Input Channel.

After clicking OK in the first dialog a second appears:

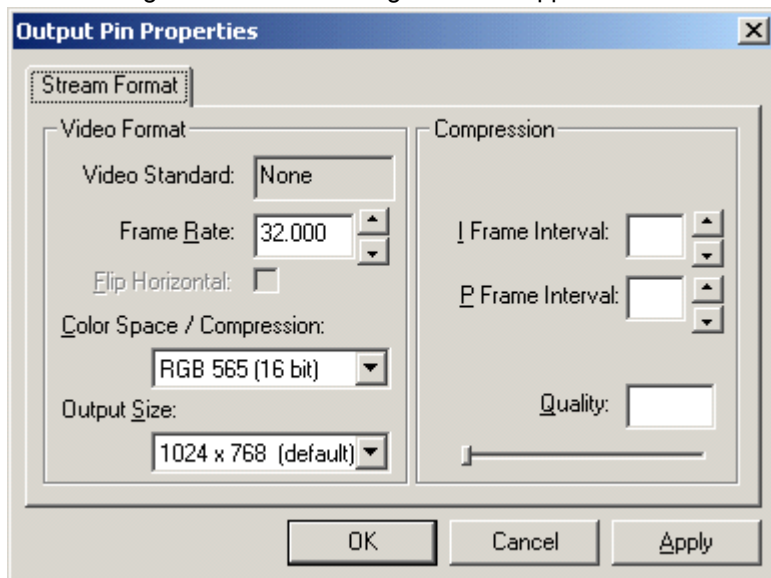

Please choose the desired frame rate, the Colour Space (RGB 565 or RGB 32) and the Output Size and if necessary the Compression.

#### 7.4.2 WINNOV VIDEUM 4400 VO / XPRESS (Composite)

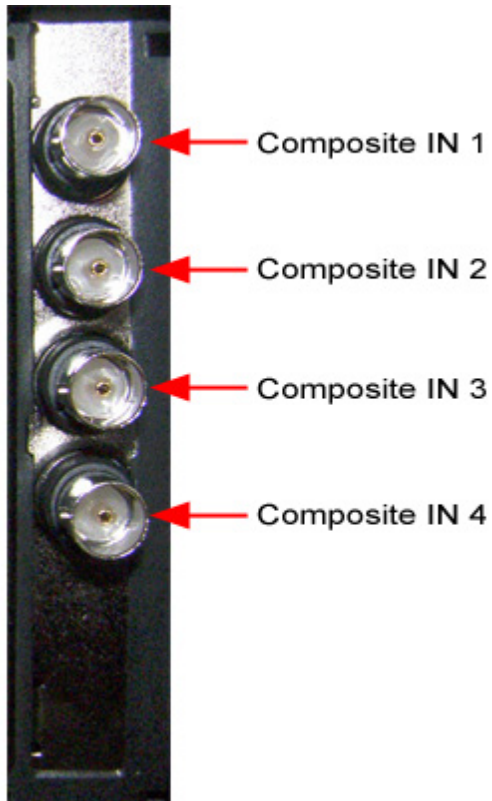

#### Configuration

Please note:

Make sure to always use the up-to-date driver from our homepage. Visit our user forum [www.coolux.de/kb](http://www.coolux.de/kb), you will find all input card drivers under Downloads - Drivers - Input Card drivers. A short registration is required.

To configure the Composite Capture Card, please click on [Configure Live Inputs] and choose your Composite Capture Card from the live input list (Client Mode) or mark your Input Device in the Project Tab and click on [Configure] in the Inspector Tab (Master Mode).

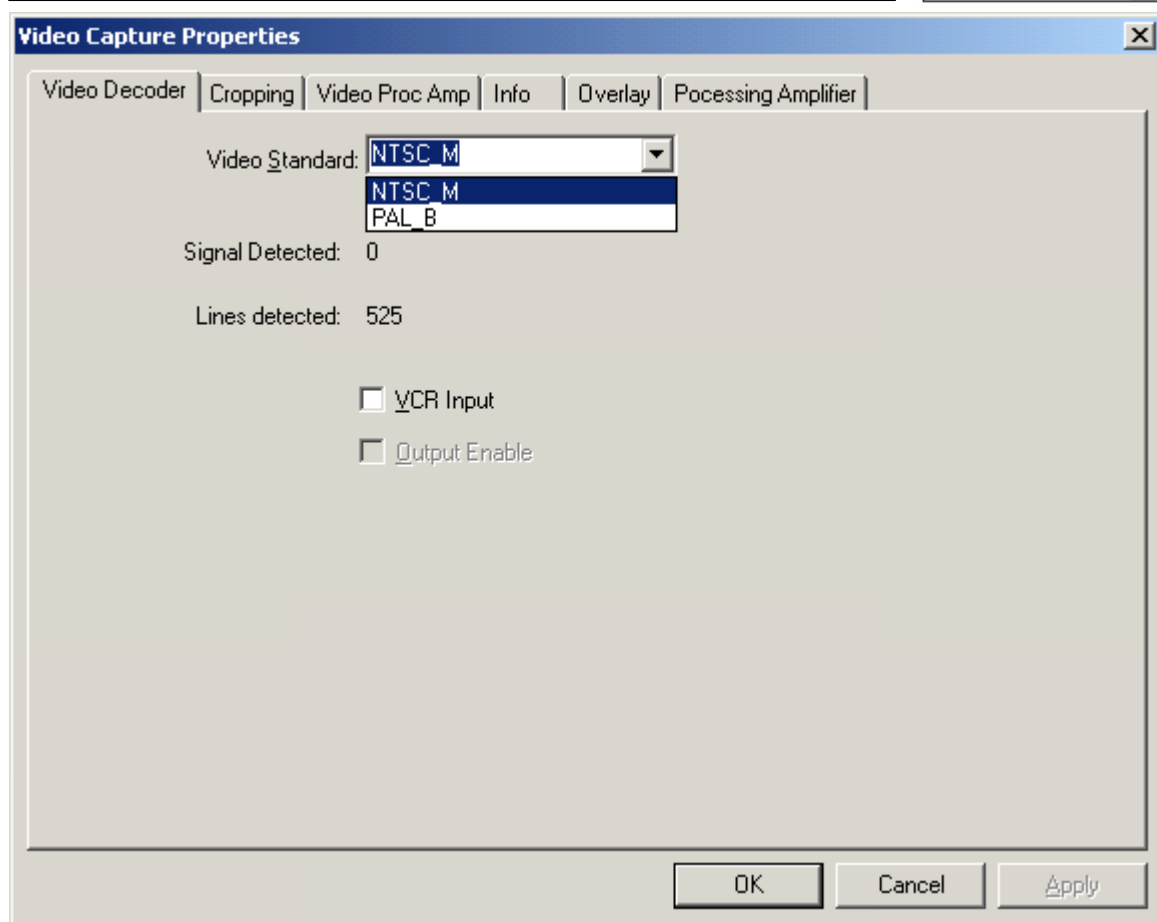

Choose the video standard (NTSC or PAL).



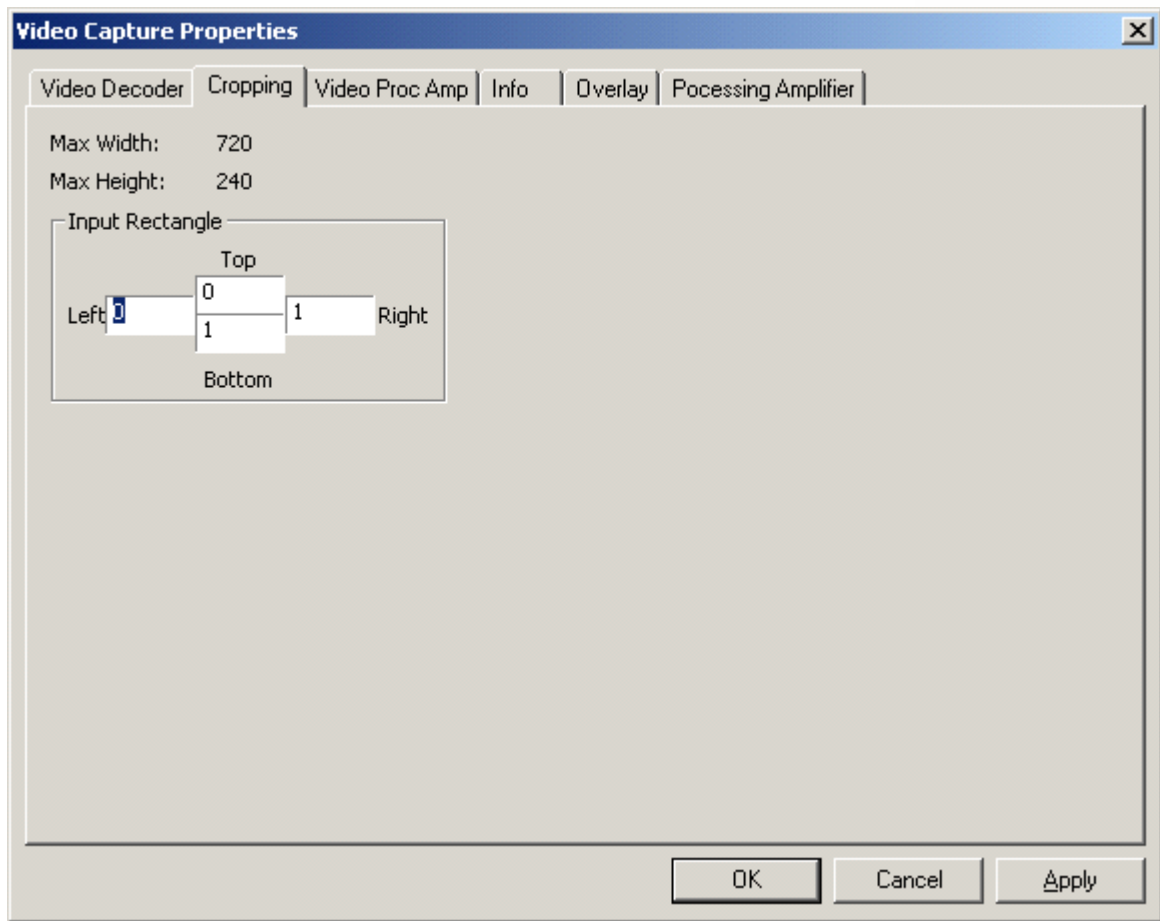

If you want to crop some parts of the input signal (for example a timecode at the bottom), do it by defining values for the 4 sides of the Input Rectangle.

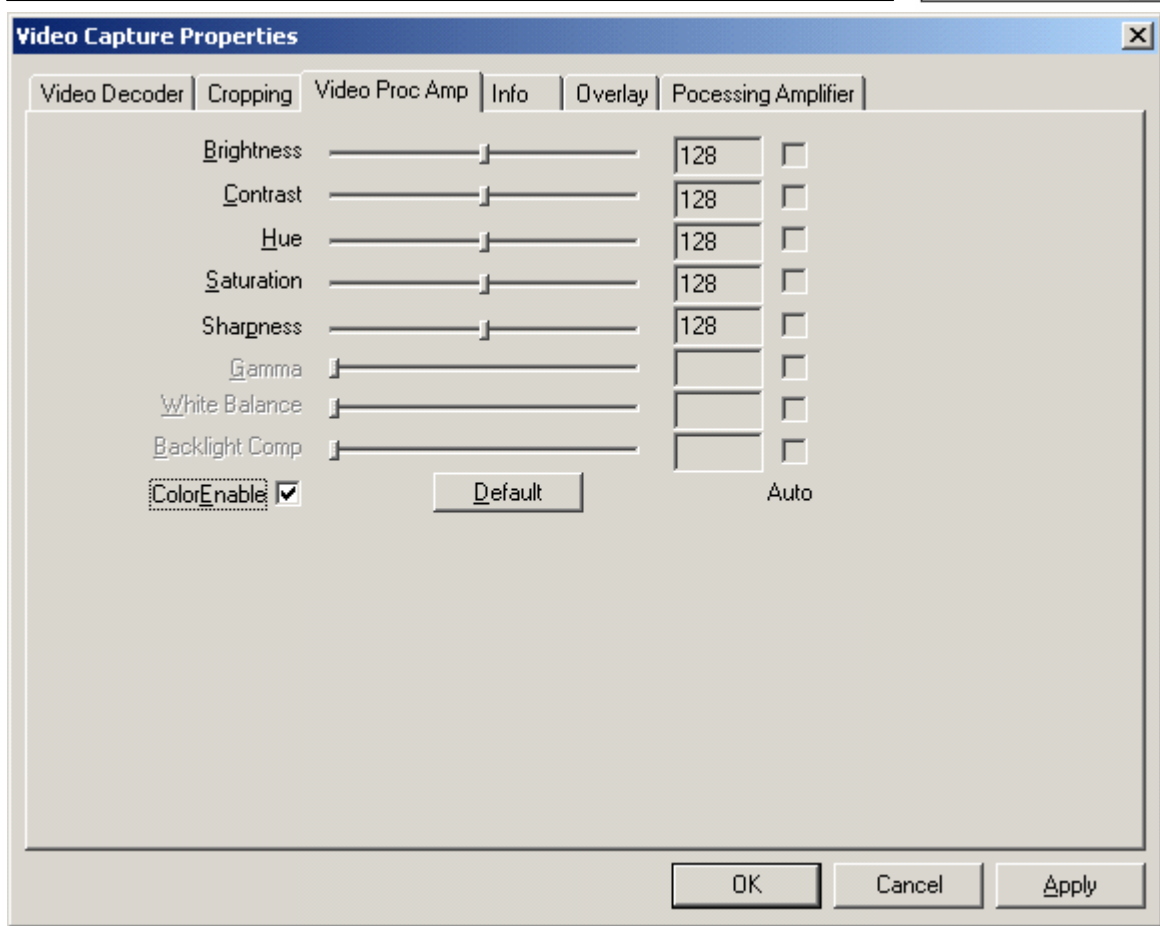

Brightness, Contrast, Hue, Saturation and Sharpness of the Input Signal can be adjusted by moving the faders.

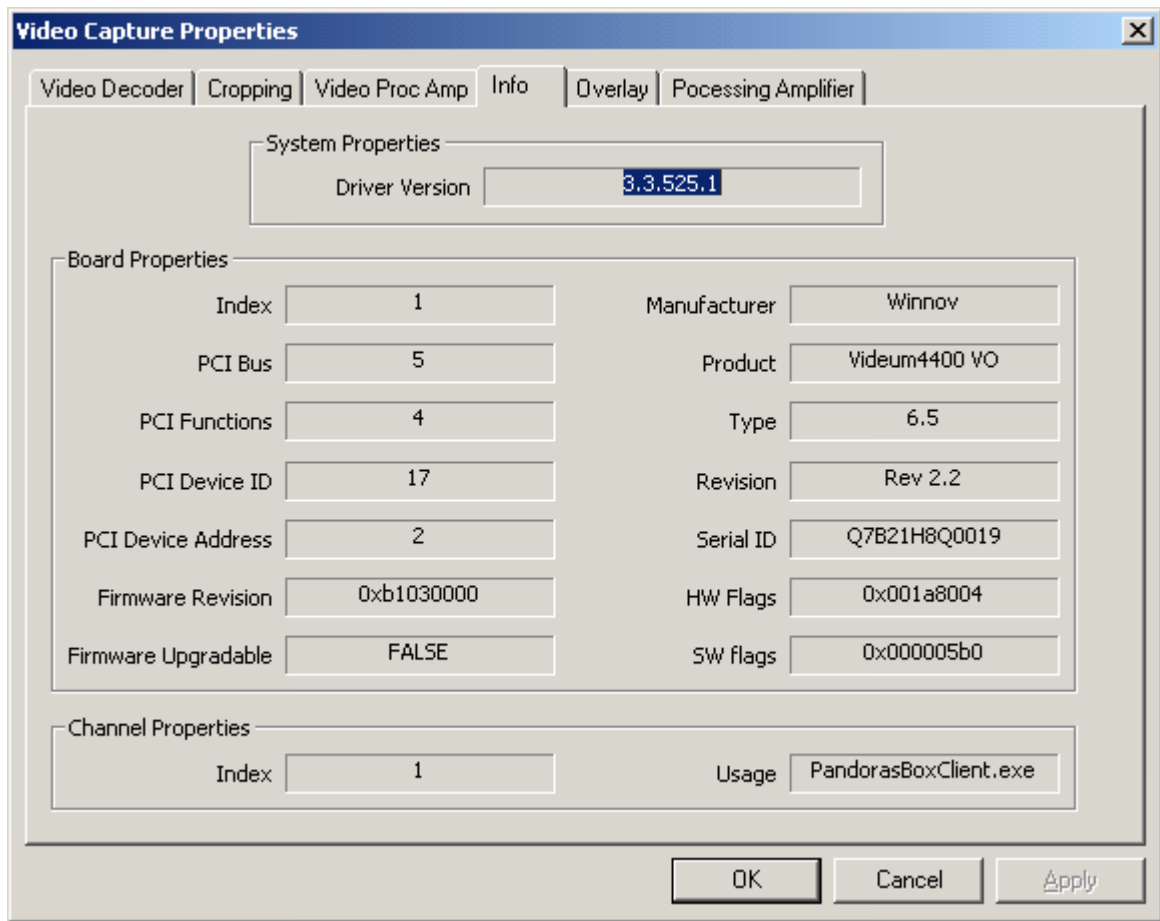

The Information Control Panel simply provides useful information such as the product name, installed driver version, and PCI bus number. This information may be requested by our support if a problem occurs.

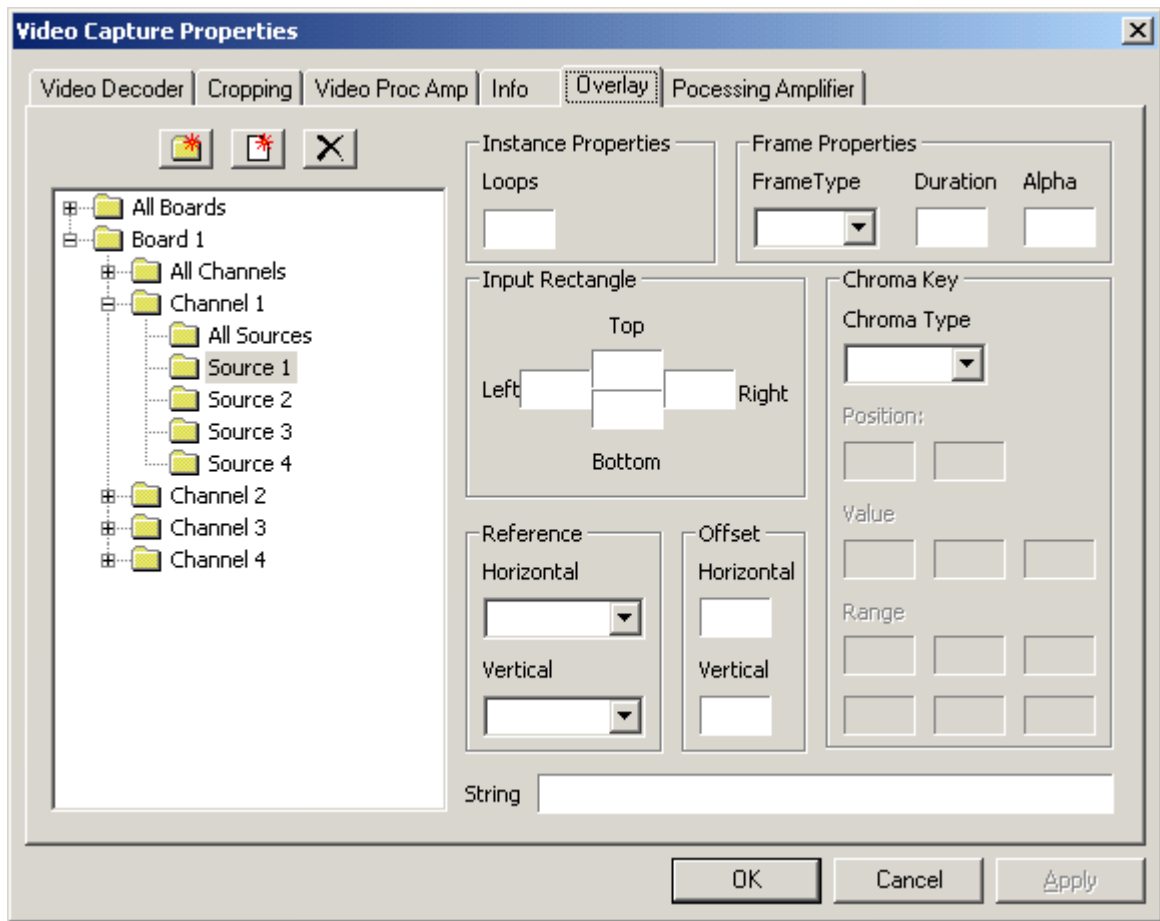

The Overlay Tab, in which you normally can add graphics as an overlay on the image, is enabled by using with Pandoras Box.

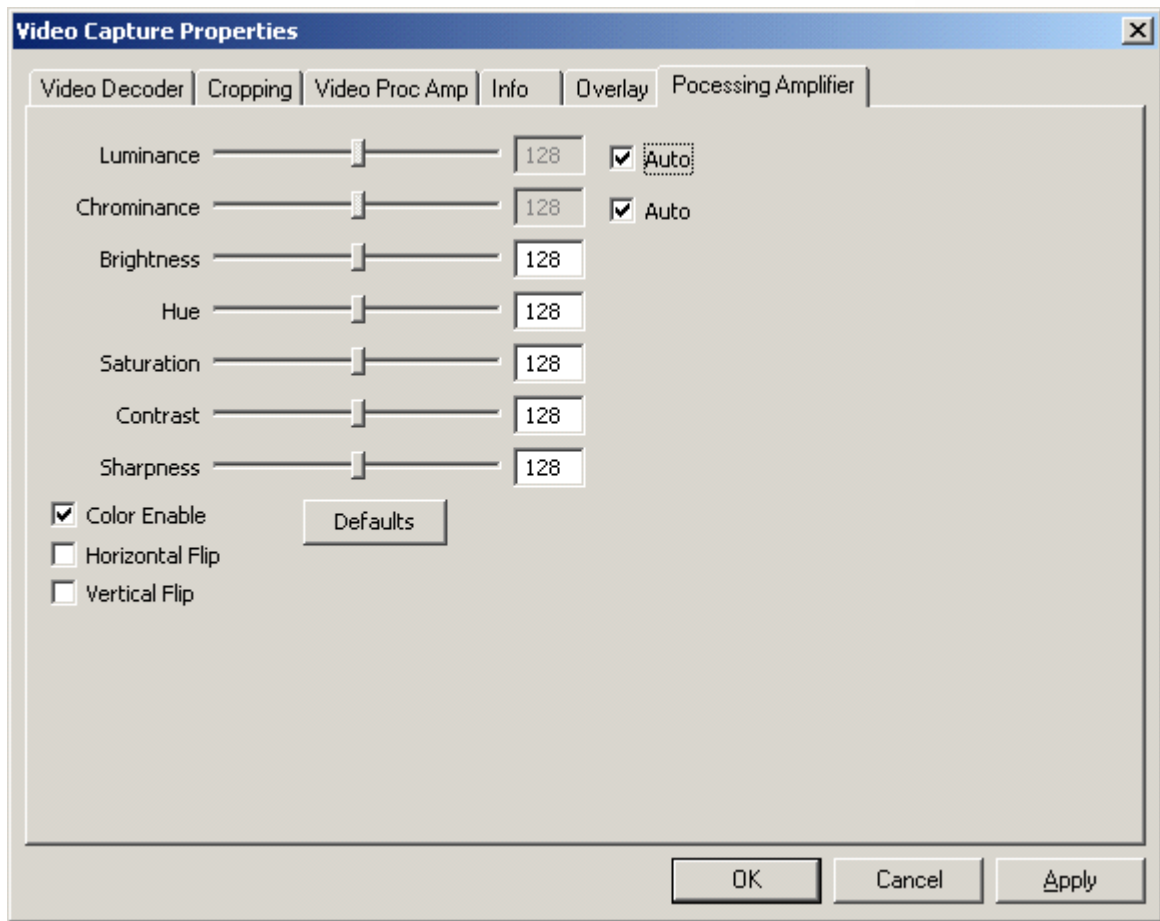

In the Processing Amplifier Tab an automatic luminance and chrominance control is set by default. By unchecking 'Auto' you can set new values manually.

To set new values for brightness, hue, saturation, contrast and sharpness you can do it by moving the faders left and right or typing the values in the textboxes next to the faders.

To capture the input signal in grey scale, uncheck 'Color Enable'. You may also flip the image horizontally or vertically.

After clicking OK the Output Pin Properties Dialog appears. Please set here the frame rate, colour space and output size.

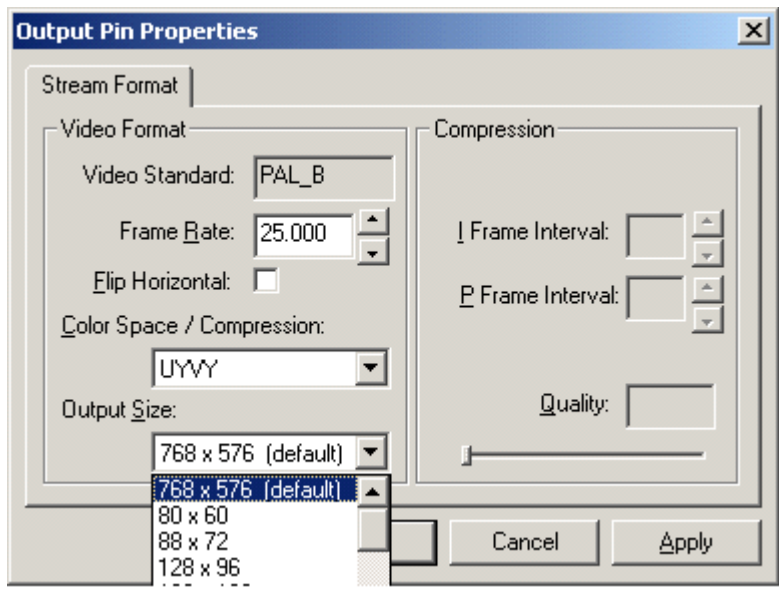

Please note:  
 Using the Winnov Videum Video Control Panel (you will find it here: WindowsStart/Programs/Winnov/Videum/Video Control Panel) you also can adjust the processing amplifier settings per board/channel/ source. The settings are modified out of process and independent of software using the drivers.

As the Winnov Videum Capture Card works like a matrix, you can set in the Video Control Panel you can set which physical source will be linked to which channel.

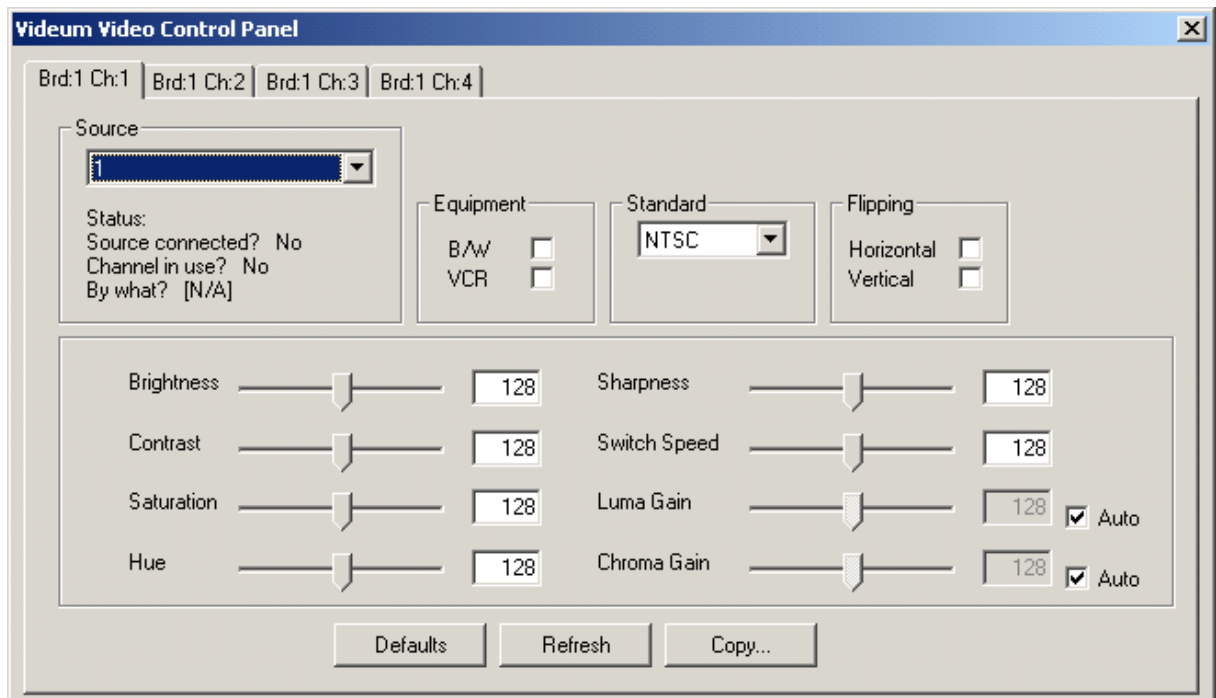

To do this, choose the channel from the 4 channel tabs and set the source by the source scroll down list.

After clicking OK the Output Pin Properties Dialog appears. Please set here the frame rate, colour space and output size.

### 7.4.3 DECKLINK SD SDI VIDEO CAPTURE CARD

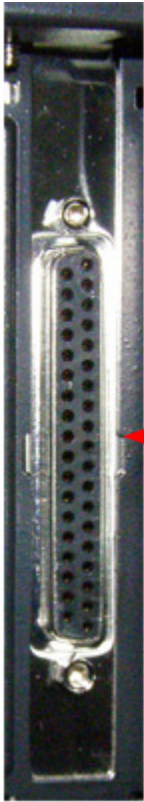

Decklink Breakout Cable:

- SD-SDI IN
- Component IN
- Composite IN

#### Configuration

Please note:

Make sure to always use the up-to-date driver from our homepage. Visit our user forum [www.coolux.de/kb](http://www.coolux.de/kb). There you will find all input card drivers under Downloads - Drivers - Input Card drivers. A short registration is required.

To configure the Decklink Video Capture Card, please click on [Configure Live Inputs] and choose your Decklink Video Capture Card from the live input list (Client Mode) or mark your Input Device in the Project Tab and click on [Configure] in the Inspector Tab (Master Mode).

In the Video Capture Properties it is only possible to set the Video Format and the frame rate for the captured SDI-signal.

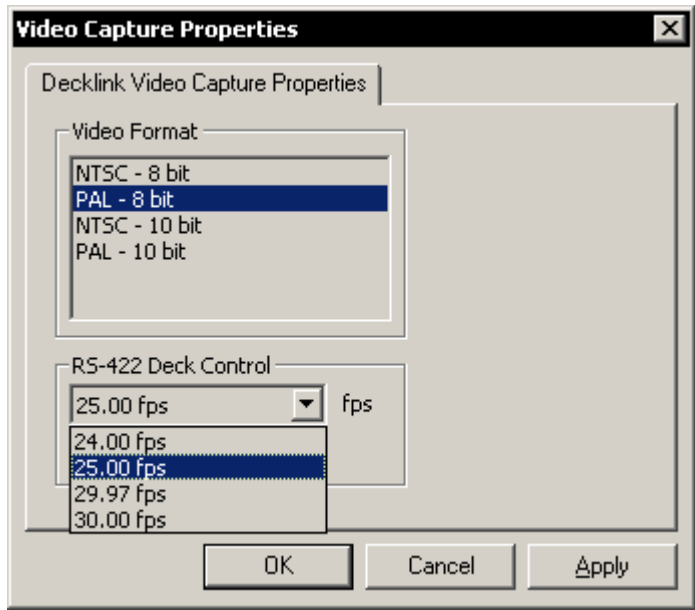

If you want to use a different input signal, please set up the driver under windows.

### 7.4.4 COOLUX SD SDI CAPTURE CARD

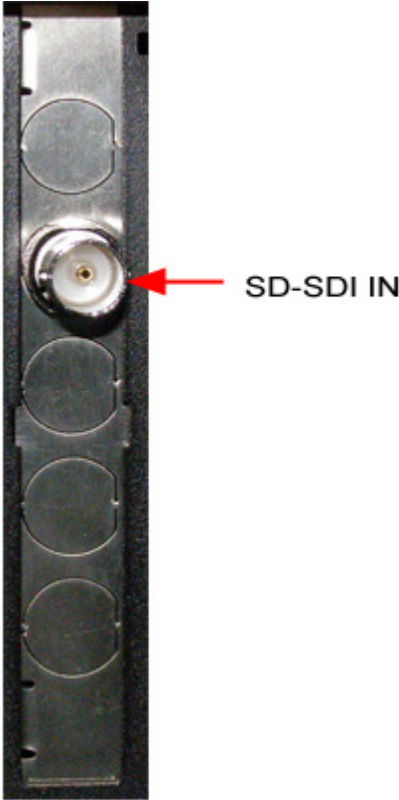

#### Configuration

Please note:  
Make sure to always use the up-to-date driver from our homepage. Visit our user forum [www.coolux.de/kb](http://www.coolux.de/kb), you will find all input card drivers under Downloads - Drivers - Input Card drivers. A short registration is required.



To configure the coolux SD SDI Capture Card, please click on [Configure Live Inputs] and choose your SD SDI Capture Card from the live input list (Client Mode) or mark your Input Device in the Project Tab and click on [Configure] in the Inspector Tab (Master Mode).

When your source is connected, you may check the automatic input type detection or manually choose your video format from the scroll down list.

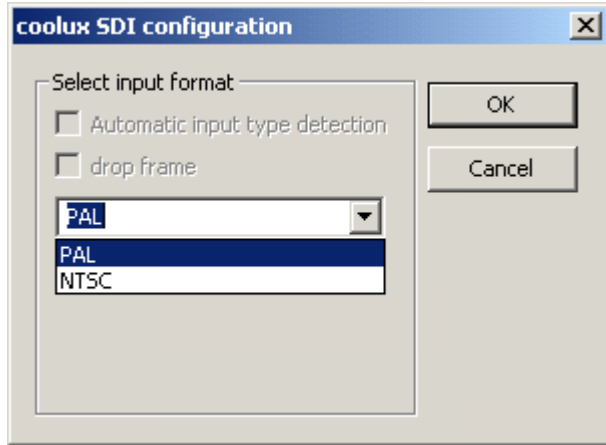

### Supported Video Signal Standard

The coolux SD SDI Capture Card supports SMPTE 259M-C.

### 7.4.5 COOLUX HD SDI CAPTURE CARD

See below on the left side the new coolux HD SDI input card. On the right side the older version is shown.

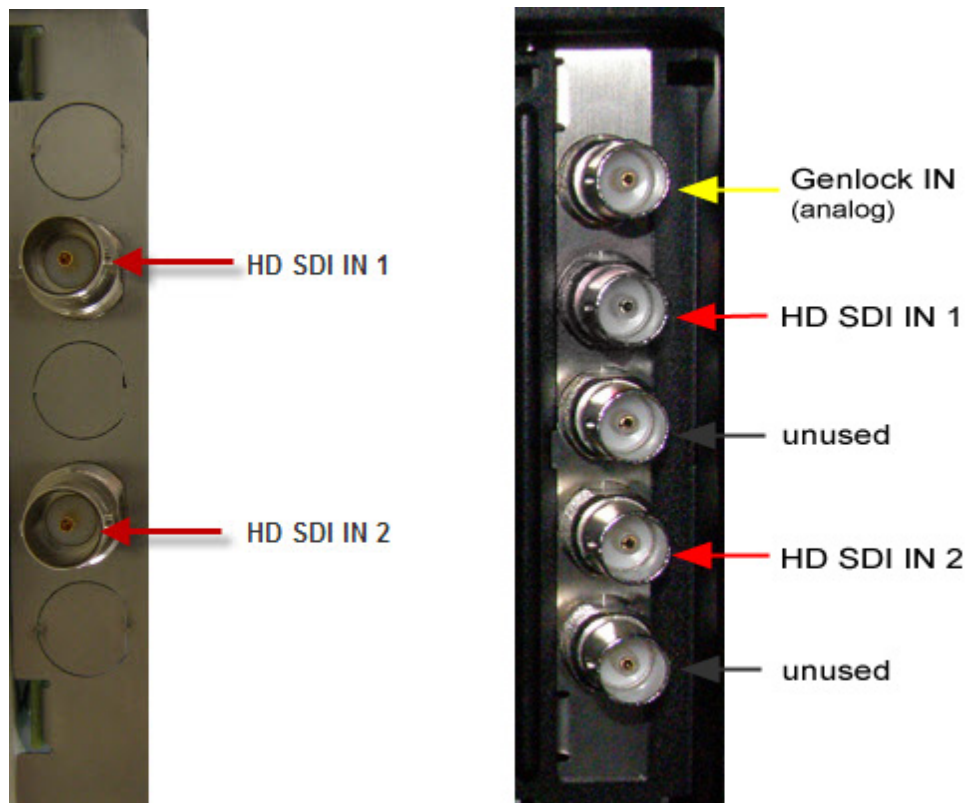

## Configuration

Please note:

Make sure to always use the up-to-date driver from our homepage. Visit our user forum [www.coolux.de/kb](http://www.coolux.de/kb), you will find all input card drivers under Downloads - Drivers - Input Card drivers. A short registration is required.

To configure the coolux HD SDI Capture Card, please click on [Configure Live Inputs] and choose your HD SDI Capture Card from the live input list (Client Mode) or mark your Input Device in the Project Tab and click on [Configure] in the Inspector Tab (Master Mode).

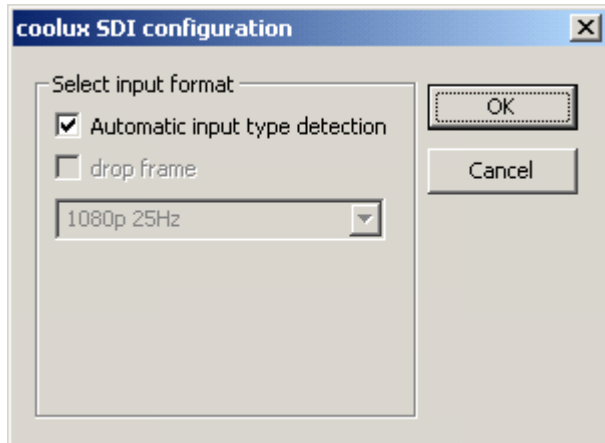

When your source is connected, you may check the automatic input type detection or manually choose your video format from the scroll down list.

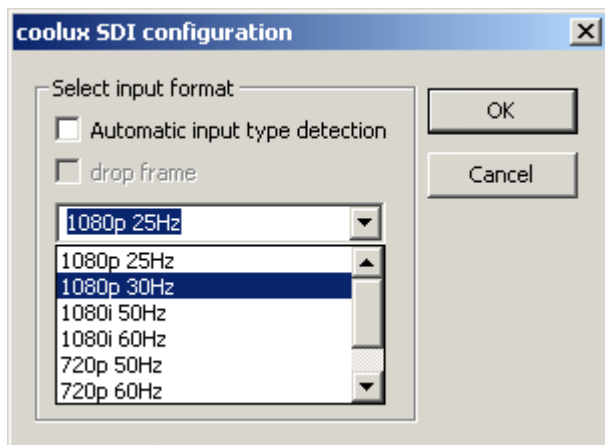

## Supported Video Signal Standard

Every input channel is independent and SMPTE 259M-C and 292M (SD or HD SDI) compliant.

- HD formats as per SMPTE 274M and 296M
- SD formats as per ITU-R BT.601-5 part A
- Dual Link support as per SMPTE 372M

## 7.4.6 COOLUX DUAL DVI CAPTURE CARD

Please note:

The coolux Dual DVI Capture Card currently supports from now on DVI-D (DVI Digital) as well as DVI-A (DVI Analog).

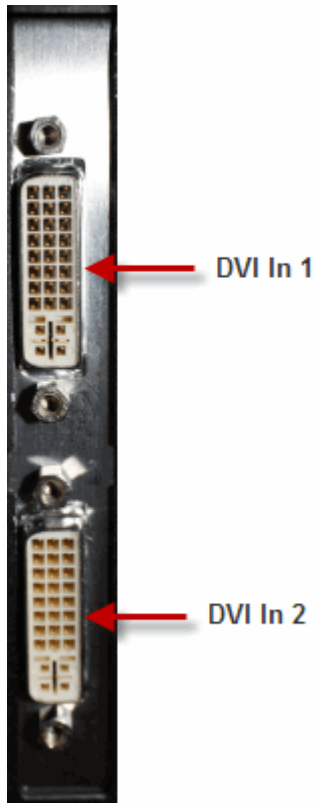

### Configuration

Please note:

Make sure to always use the up-to-date driver from our homepage. Visit our user forum [www.coolux.de/kb](http://www.coolux.de/kb), you will find all input card drivers under Downloads - Drivers - Input Card drivers. A short registration is required.

To configure the coolux Dual DVI Capture Card, please click on [Configure Live Inputs] and choose your coolux Dual DVI Capture Card from the live input list (Client Mode) or mark your Input Device in the Project Tab and click on [Configure] in the Inspector Tab (Master Mode).

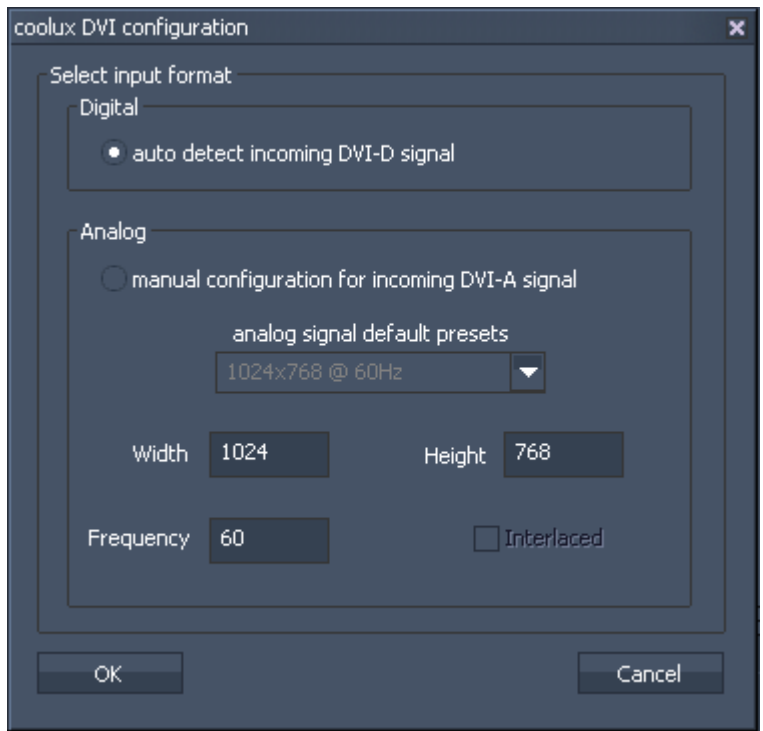

Select “auto detect incoming DVI-D signal” when capturing a digital DVI signal. Here you do not have to define the signals resolution.

When capturing an analog DVI signal, please check the option “manual configuration for incoming DVI-A signal” and choose the correct signal type from the drop-down list or type in the resolution and frequency in the textboxes below.

Confirm your configuration by pressing [OK].

**7.5 CONTROLLER BOARDS**

The Jog Shuttle Controller and the Fader Board Extension can be purchased as an optional accessory for Pandoras Box products, e.g. a Manager.

The [Jog Shuttle Controller](#)<sup>709</sup> allows to control up to two sequences. Based on the selected sequence 16 cue buttons let you go to 16 cues directly.

The [Fader Controller](#)<sup>710</sup> is the extension for the Jog Shuttle Controller and allows to control up to 6 sequences.

See here information about the products [Jog Shuttle](#)<sup>711</sup> (discontinued) and [Playback Extension](#)<sup>712</sup> (discontinued).

### 7.5.1 JOG SHUTTLE CONTROL

The Jog Shuttle Controller is available to control up to two sequences.



Based on the selected sequence (use the select button for each sequence) the top 16 cue buttons let you go to 16 cues directly.

Based on the selection, use the Jog Shuttle controller to navigate back and forth through the timeline. The fader on the left will control one sequence; the fader on the right will control a second sequence.

Please note:

The faders and cue buttons need to be mapped in Pandoras Box in order to control the sequences and to jump to cues! Use the [Controller Setup Tab](#)<sup>159</sup> in Pandoras Box Master System to set up this mapping.

#### FADER CONTROLS+

SELECT (Button above fader):

Selects the sequence. The blue led on the button will light as indicator for the selection.

As soon as a sequence is selected, all Cue Buttons as well as the Jog Dial and the Playback Buttons are linked to this sequence!

LED light status:

Blue LED is on: Sequence is selected.

Red LED is blinking: Sequence status is "Play"

Red LED is on: Sequence status is "Pause"

FADER:

Controls the sequence opacity.

Fader position on top = Opacity FULL

Fader position at bottom = Opacity 0%

PLAY/PAUSE (Button below fader):

Toggles the Sequence between Play and Pause. This Play/Pause Button can be used without having the sequence selected via the SELECT-Button.

#### CUE BUTTONS

For each sequence you may assign the 16 Cue Buttons via the Controller Setup Tab in Pandoras Box. Depending on the selected sequence, the Cues Buttons are linked to this sequence.

The last Cue Button pressed will light up in blue.

#### JOG DIAL

The Jog Dial allows scrolling through the selected sequence:

The inner knob allows scrolling frame by frame, the outer knob does a faster scrolling.

#### PLAYBACK BUTTONS

Depending on the selected sequence, the Playback Buttons are linked to this sequence.

#### LAST / NEXT CUE

These buttons allow to step backward / forward from cue to cue.

#### PLAY / PAUSE

This button toggles the selected sequence between the playmodes Play and Pause.

## 7.5.2 FADER EXTENSION



The Fader Controller Board acts as extension for the [Jog Shuttle Controller](#)<sup>709</sup>. It allows controlling 6 more sequences.

The faders need to be mapped in Pandoras Box in order to control the sequences! Use the [Controller Setup Tab](#)<sup>159</sup> in Pandoras Box Master System to set up this mapping.

#### FADER CONTROLS

**SELECT** (Button above fader):

Selects the sequence. The blue led on the button will light as indicator for the selection.

As soon as a sequence is selected, all Cue Buttons as well as the Jog Dial and the Playback Buttons are linked to this sequence!

**LED light status:**

Blue LED is on: Sequence is selected.

Red LED is blinking: Sequence status is "Play"

Red LED is on: Sequence status is "Pause"

**FADER:**

Controls the sequence opacity.

Fader position on top = Opacity FULL

Fader position at bottom = Opacity 0%

**PLAY/PAUSE** (Button below fader):

Toggles the Sequence between Play and Pause. This Play/Pause Button can be used without having the sequence selected via the SELECT-Button.

As soon as a sequence is selected on the Fader Extension, the Cue Buttons, the Jog Dial and the Playback Buttons on the Jog Shuttle Controller are assigned to this selected sequence.

See the [Jog Shuttle Controller](#)<sup>709</sup> for more information about Cue Buttons, Jog Dial and Playback Buttons.

### 7.5.3 JOG SHUTTLE CONTROL (DISCONTINUED)

The Jog Shuttle Controller is available to control up to two sequences.



Based on the selected sequence (use the select button for each sequence) the top 18 cue buttons let you go to cue 1-18 directly.

Based on the selection, use the Jog Shuttle controller to navigate back and forth through the timeline.

The keyboard block on the left will control the sequence with the ID 1, the block on the right will control the sequence with the ID 2.

For each sequence choose:  
 SELECT: selects the sequence  
 ON/OFF: to hide all layers from the selected sequence  
 KEY LAST/NEXT  
 CUE LAST/NEXT  
 STOP PAUSE  
 PLAY

Use the "STORE" key to store all currently active value to the selected sequence.  
 Use the "CUE" key to store a new cue at the current time of the selected sequence.  
 Use "COPY" and "PASTE" for key frames in the selected sequence.  
 Use "RESET" to reset all devices to default.  
 Use "DELETE" to delete chosen keys in the selected sequence.

**7.5.4 PLAYBACK EXTENSION (DISCONTINUED)**



The Playback Extension enables a Pandoras Box Manager PRO to control up to 8 individual sequences directly, plus giving access to the command line architecture via the numeric keypad and dedicated command buttons.

Depending on the desired operation, any command line input must be started with a mode button:

"VIEW", "GROUP", "DEVICE", "SEQUENCE", "PRESET" and ends with pressing the "ENTER" key.

**DEVICE CONTROL**

Within the device tree, all items are organized in nodes that the devices belong to. In the properties you can assign a unique ID for both nodes and devices. For example if you have a Pandoras Box Server in the device tree, its node ID might be set to 1 and the individual layer ID count from 1 to 10.

DEV 1.5 Enter  
 to select layer 5 of node 1.



Once a device is selected, you may use the encoders to adjust the parameters values.

To select multiple devices you can keep adding devices to you current selection by simply selecting another one.

To clear your current selection press "CLEAR" once.

You may also use the "+" or "THRU" key to select multiple devices at once. For example: DEV 1.1 thru 1.10 Enter or DEV 1.1 + 1.3 Enter.

Once you start changing values with the encoders, wiper or joystick, all changed values will turn red and get indicated as active values. Active values will be processed during a store-operation. If a parameter is inactive it will not be stored at any time.

To de-activate and reset individual values to default, hold down the "RELEASE" key and turn the desired parameter encoder. In the device tree, the same operation can be achieved by right-clicking on the individual parameter and choosing "CLEAR ACTIVE". If you want to clear all active values you may also double click the "CLEAR" button. To reset all parameters back to default you may click the "CLEAR" button three times.

The same commands are also available from the right-click menus in the user-interface in the device tree or by right-clicking in the time-bar of a sequence.

#### Device Command Overview

[Preview DEV 1 Enter]

switches the preview window to display the selected device

[Dev 1.1 Enter]

selects device 1.1 and allows access to encoders and parameters

[Dev1.1 + 1.2 Enter]

selects device 1.1 and 1.2

[Dev1.1 thru 1.11 Enter]

selects all devices from ID 1.1 to 1.11

[Align]

Based on the align setting <, >, <> or >> when multiple devices are selected you may align the parameters according to the align setting.

[Clear 1x]

Clear Selection

[Clear 2x]

Clear Active

[Clear 3x]

Reset All

[Release + Encoder]

de-activates and resets parameters to default of current selection

[Dev 1.1 Enter Enter]

sets all parameters of selected devices to active

[ @@ ]

sets opacity value to 255 (100%)

#### GROUPS

If you need to control a single layer on multiple machines or to add the same values to multiple layers at once, the device tree control tab allows you to select multiple devices at the same time by clicking and holding the CTRL key.

All selected device icons will turn white, showing that they are selection members.

To release the current selection press ESC or press "CLEAR" once.

Please note:

When multiple devices are selected, all changes of parameter values will apply to all members of the selection.

### Creating & Editing Groups

Once a single or multiple devices is/are selected, you can store this specific selection as a group in the group bin of the project tab.

To create a group, please select the desired devices, then right-click on the group bin in the project folder and choose 'create group' or type "Store GRP 5 Enter" to create a new group of the current selection with the ID 5.

To delete a group, right-click on the group element in the project and choose "REMOVE" or type "Delete GRP 5 Enter".

HINT: When working in device tree editing, you may also use the right-click menu on groups to determine if the members of the group should be activated, de-activated or reset.

### PRESETS

Individual preset banks can be created by right-clicking on the preset folder in the project tab.

For each folder you may open a designated browser as a tab to be stored in views.

The presets are designed to hold a snap shot of active values, to be reused for later programming.

Presets apply to all selected devices. As source, the first stored values for each individual type of parameter are taken. When creating a preset with two layers that have different opacity values only the opacity value for the first selected layer will be applied when assigning the preset on a selected device. Applying a preset always causes setting relevant parameters to active.

The preset folder contains default preset banks for active value filtering during store operation.

This means that by right-clicking on any of these categories only the parameters that match the category group will be stored there as a new preset.

Global	All Parameters
INT	Opacity, Transition FX
PRS	Position, Rotation, Scale
MEDIA	File Selection, Playback Controls
OBJ	Object Selection
COL	Colour FX
AUDIO	TBA
FX	Video FX
CTRL	Camera Control Settings

### Preset Commands

[Store|ID.ID|Enter ]  
stores a new preset with specified ID.

[Delete|ID.ID|Enter]  
deletes selected preset.

[ID.ID|Enter]  
if no device is selected, the preset will recall the value to the stored selection  
If devices are selected, the selected preset will be assigned to the entire selection.

## SEQUENCE CONTROL

To create a new timeline, enter the following on the console:  
"Store SEQ 1 Enter" or simply right-click on the sequences folder in the project tab.

Once the timeline is created, you will have access to it in the sequence tab by selecting it in the project bin.

Similar to the device control, all sequences can have a unique ID within the project. The ID can be set during the store operation from the console or via the properties of the sequence itself.

To load a SEQ into the jog shuttle controller type "SEQ 1 Enter"

To load the SEQ into the sequence tab type "Edit SEQ 1 Enter"

To go to a specific timecode in the selected sequence type "Goto Time hhmssff Enter"

Time-format is interpreted like this: Hours minutes seconds frames.

You can also type in "1000" => timecode 00:00:10:00.

To generate these new keys in the timeline, you will then have to right-click on the time-bar and choose "Store active" or type "Store Enter" to store all active values at the current time in the selected sequence.

## SEQUENCE COMMAND OVERVIEW

Store|Enter – stores all active values at current time of selected sequence.

Store|Seq|X|Enter – stores new sequence with ID X

Store|Cue – stores new cue at current time of selected sequence.

Delete|Seq|X|Enter – deletes specific sequence.

Seq|X|Enter – selects Seq X and loads to Jog Shuttle Controller.

Goto|Time|XX|Enter – jumps to Timecode XX. Use syntax HMSF or e.g. "105" for Timecode 00:00:01:05

Goto|Cue|XX|Enter or Goto|XX|Enter – jumps to Cue XX

Goto|Time|+/-|HMSF|Enter – relative movement in the current sequence with the time value HMSF.

Store|Time|HMSF|Playback button – stores active values to the sequence controlled by playback button.

Store|Cue|XX|Enter – stores active values at time of cue XX in selected sequence.

Store|Cue|XX|Time|HMSF|Enter – creates cue with ID xx at time HMSF in selected sequence.

Store|@|Cue|XX|Enter – stores active values and creates cue XX in selected sequence.

Store|@|Cue|XX|Time|HMSF|Enter – stores active values and creates cue with ID XX at time HMSF in selected sequence.

Delete|Cue|ID|Enter – deletes selected cue.

Delete|Cue|ID|Thru|ID|Enter – deletes cues within selected ID range.

Delete|Time|HMSF|Enter – deletes all keys at selected time.

Delete|Time|HMSF|Thru|HMSF|Enter – deletes all keys in selected time range, independent of activation of selection of devices.

Delete|@|Cue|ID|Enter – deletes all keys at time of the selected cue ID.

Delete|@|Cue|ID|Thru|ID|Enter – deletes all keys in selected sequence which are between the entered Cue IDs.

Delete|TYP|...|Enter, with TYP @, Cue, or Time – can now be applied to another sequence than the selected sequence, if directly after “DELETE” follows the number of the sequence.

#### View Commands

Store|ID|Enter – stores the current view-layout as a new view with specified ID.

Delete|ID|Enter – deletes selected view ID.

## 7.6 SENSOR LINK

The Sensor Link is a unique highspeed sensor interface that is designed to provide input signals from standard industrial encoders, distometers as well as analog potentiometers and contact closures.



### 7.6.1 TECHNICAL FEATURES

From one unit there can be used simultaneously:

- 2x 12V [industrial encoder](#)<sup>719</sup> inputs with internal or external reset (GPI) with 5-pin M12-Connectors,
- 2x 0-10V [analog inputs](#)<sup>718</sup> and
- 8x GPI [contact closures](#)<sup>718</sup>

Since the SensorLink is based on TCP/IP communication (outputs TCP/IP at variable frequency between 50 and 5000 Hz), multiple units can be used at the same time.

The internal sample rate reads incoming data at 7 kHz to allow high resolution encoder inputs to be used for accurate motion sensing.

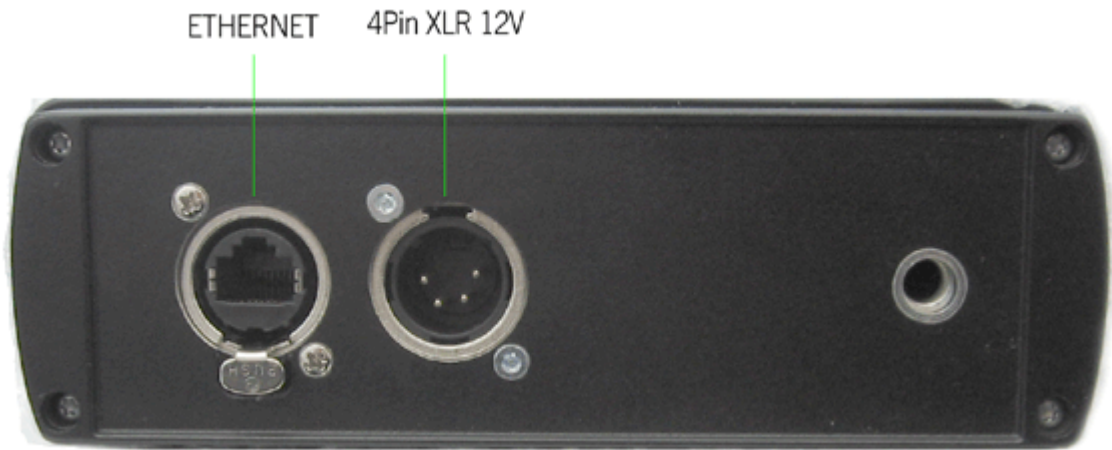

The front panel shows the Neutrik Ethernet input jack as well as the 4 pin XLR 12V power input.

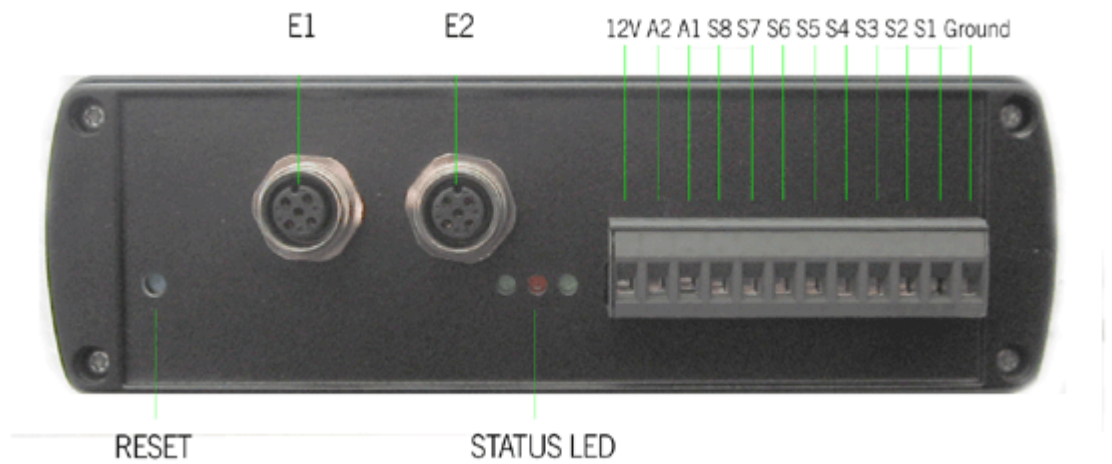

On the rear side you will find the connection for encoders (E1 & E2, please use 5-pin M12-Connectors, Pin Connections: 1= +Volt, 2=B, 3=0Volt, 4=A, 5= N Index), analog devices (A1 & A2) and contact closures S1 – S8).

#### RESET

As the unit can be programmed for various encoder step count settings or remote rest indexing a reset button is provided to restore the factory settings of the unit.

**STATUS LED**

Three status LEDs give feedback information of the current state of the unit.

**7.6.2 CONNECTING ENCODERS AND SENSORS**

You may connect the following inputs to the Sensor Link Device:

- [Analog inputs with their own voltage supply of 0-10 Volt<sup>718</sup>,](#)
- [Switch Inputs with or without their own voltage supply of 12 V<sup>718</sup>,](#)
- [Incremental Encoders, using 5-pin M12-Connectors<sup>719</sup>,](#)

Please never connect Pin 12 and Pin 1 as this could cause a short circuit!

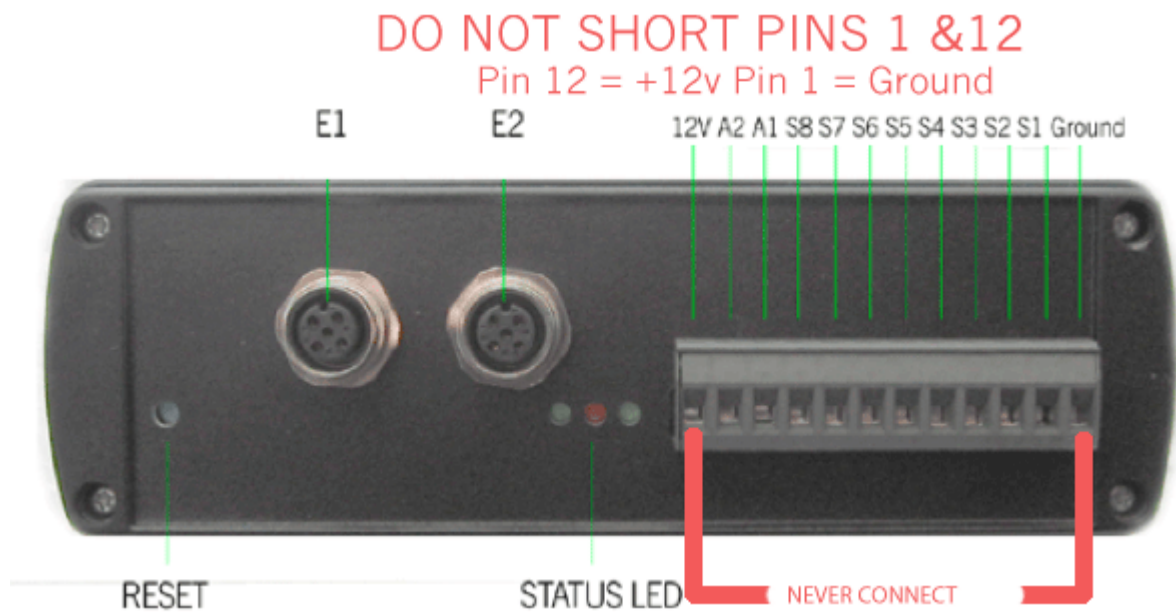

**7.6.2.1 ANALOG INPUTS A1 AND A2**

Connect – to Ground and the gate input to A1 or A2. The sensor link will read out a voltage range of 0-10 Volt and will transfer this range in 512 steps. They have 30kΩ input impedance, resulting in a minimum of 0,5A.

Please make sure that you are using the same grounding in order not to get any potential equalization!

**7.6.2.2 SWITCH INPUTS S1-S8**

It is recommend to use potential-free relay contacts as triggers. Connect these to 12V and to one of the Switch Inputs S1-S8.

If you are using triggers with their own voltage supply (11-13 V) connect – to Ground and the gate input to one of the Switch Inputs S1-S8.

Note that the contacts should not be switched faster than twice per second to be recognized correctly. 4 times (4 Hz) could be reached under circumstances, but maximal 2Hz is recommended.

Please make sure that you are using the same grounding in order not to get any potential equalization!

### 7.6.2.3 ENCODER INPUTS E1 AND E2

You may connect incremental Encoders to input E1 or E2, using 5-pin M12-Connectors.



Pin assignment female connector:

Pin 1 = positive power supply, +12V or +24 V

Pin 2 = Pulse signal B

Pin 3 = negative power supply, Ground

Pin 4 = Pulse signal A

Pin 5 = Pulse signal N, Reset

Guideline for choosing the right Encoder:

In order to specify the right encoder for your application, a couple of parameters need to be determined first.

- What kind of encoder should it be? Hollow Shaft Encoder or Shaft Encoder
- The diameter of the axis where the encoder should be mounted to
- Minimal and maximal speed of the axis. Measured in rotations per second

In general you might say: the more steps the encoder has, the better is the result, BUT it is important to know that the coolux Sensor Link is limited to a maximum of 7000 steps per second.

If the encoder turns faster and generates more steps per second, the Sensor Link will lose track of the absolute step count of the encoder. This can lead to drifting and wrong values, if the Sensor Link is being used for accurate Screen Tracking.

To avoid this, it is recommended to specify an encoder that will run at a maximum amount of 6000 steps per second.

!!! Please be aware that 6000 steps are not equal to rotation per second or Pulses per Revolution!!!

Due to the output circuit data of the encoder (which is a HTL) there are four shoulders for one circuit. That means for example: An encoder with 1500 PPR (Pulses per Revolution) generates 6000 steps per second at one full rotation per second. ( $4 \times 1500 \text{ PPR} = 6.000 \text{ steps/sec.}$ )

To choose the right encoder for your application you will also need to take into consideration the following:

Is there any further gear mounted on the device which is turning?

Is the shaft, where the rotation is coming from, bigger than the axis of the encoder?

This is why you need to know the environment of where the encoder is going to be used as well as how many rotations per second the axis of the encoder will be turning.

Sensor Link has been tested with Wachendorff Encoders ([www.wachendorff.com](http://www.wachendorff.com)).

You may get similar encoders from other manufacturers as well, but the naming of the different signals and product specifications may vary.

Here is an example of how to determine the right product code for a Wachendorff encoder suitable for Sensor Link.

Please Note: All the encoders are custom-built. These are not stock items!

Example encoder: **WDG40S 360 ABN H24 SB5**

- WDG40S** - is the type of the encoder – here it means that it's a shaft encoder.
- 360** - is equal to 360 PPR (Pulses per Revolution)
- ABN** - is the channel type
- H24** - determines an HTL Output circuit
- SB5** - determines the connector type, for Sensor Link a 5-Pin, M12-sensor Connector

Although encoders can be ordered with a fixed mounted cable, this is not recommended for service flexibility.

The connection cable between encoder and Sensor Link is available in various lengths.

Below graphic shows an example from Wachendorff:

Ordering information: Please see our general technical data at: [www.wachendorff-automation.com/gtd](http://www.wachendorff-automation.com/gtd)

Output circuit:				
Reso- lution PPR	Power supply VDC	Output circuit	Light reserve warning	Order Key
up to 2500	4.75 - 5.5	TTL	-	H05
		TTL, RS422 comp., inverted	-	R05
	10 - 30	HTL	-	H24
		HTL inverted	-	R24

**Channels:** AB, ABN (up to 2048 PPR)

**Pulses per revolution PPR:**  
4, 9, 10, 15, 20, 25, 28, 30, 36, 40, 50, 60, 90, 100, 120, 125, 128, 150, 160, 180, 200, 235, 250, 300, 314, 318, 360, 400, 500, 600, 625, 635, 720, 900, 1000, 1024, 1080, 1200, 1250, 1500, 1800, 2000, 2048, 2500.  
Other PPRs on request

Electrical connections:				ABN inv.
Order key	Outgoing	Description		
<b>Cable: (Length 2 m standard)</b>				
K1	radial	shield not connected (IP50)		•
K2	axial	shield not connected		•
L2		shield connected to encoder housing		•
K3	radial	shield not connected		•
L3		shield connected to encoder housing		•
<b>Connector:</b>				
SI5	axial	5-pin, connector		-
SI6	axial	6-pin, connector		-
SI8	axial	8-pin, connector		-
SI12	axial	12-pin, connector		•
S2	axial	7-pin, connector		-
SB4	axial	4-pin, M12-sensor-connector		-
SB5	axial	5-pin, M12-sensor-connector		-
SB8	axial	8-pin, M12-sensor-connector		•
SB12	axial	12-pin, M12-sensor-connector		•
<b>Options:</b>				
Empty		= Without option		
ACA		= Low-temperature -40 °C up to +80 °C		
AAC		= Low-friction bearings		
AAO		= Shaft sealed to IP67		
In decimetres		= Cable length		

**Order No.:**

Example: WDG 40S 2500 ABN H24 K2

Your encoder: WDG 40S 360 ABN H24 SB5

### 7.6.3 USER INTERFACE

The Sensor Link UI acts as the interpreter of the incoming data from a Sensor Link to a Pandoras Box Master System.

There are two different ways to use the Sensor Link to control the Pandoras Box Master software:  
- Using the Sensor Links [Configuration Tool](#)<sup>721</sup> and the Widget Designer PRO (recommended!).

This allows you to use the Sensor Link's whole functional range.  
- Using the User Interface of the [Sensor Link Software](#)<sup>723</sup> that will be delivered with the Sensor Link.



### 7.6.3.1 CONFIGURATION TOOL AND WIDGET DESIGNER PRO

For the best flexibility and to be able using the whole function range to control Pandoras Box we recommend using the Widget Designer as processing tool for the data coming from the Sensor Link.

Please start the Sensor Link Configuration Tool (for the download link, please log into the [Download-Center](#) first, then click [here](#)).

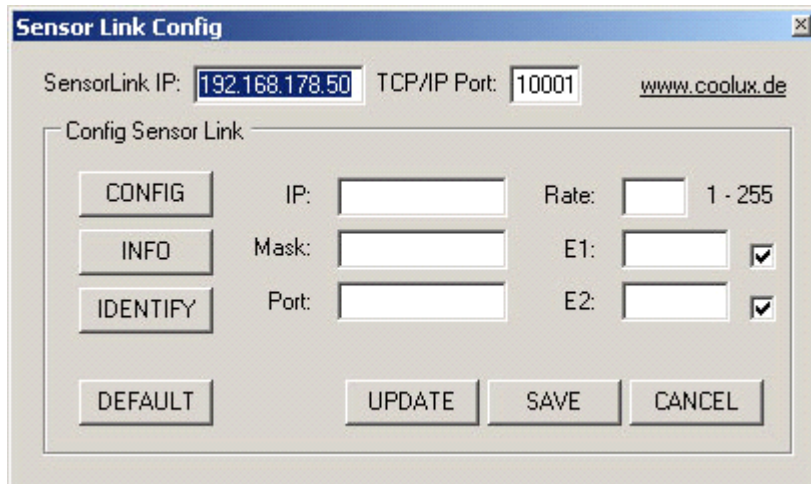

To configure the Sensor Link device, please enter the Sensor Link IP address and port and press [CONFIG]. You may now change the IP or Encoder settings if necessary:

**SensorLink IP and TCP/IP Port:**  
Enter here the Sensor Link's IP address and TCP/IP Port.

**[CONFIG]:**  
Press [CONFIG] to switch the unit to configuration mode.

**[INFO]:**  
Press [INFO] to download the current settings from the unit.

**[IDENTIFY]**  
Press [IDENTIFY] to identify the units, the right LEDs will blink for 3 seconds.

#### Changing the Sensor Links Settings

**[DEFAULT]**  
Press DEFAULT to load the default settings in the settings fields.

**IP:**  
Please enter the new IP address that you want to assign to the unit here.

**MASK**  
Please enter the new Subnet Mask that you want to assign to the unit here.

**PORT**  
Please enter the new TCP/IP Port number that you want to assign to the unit here.

**RATE**  
The Rate setting changes the transmission rate, the default of 14 is recommended as this is ~70 Hz refresh cycle in order to be ahead of any displays refresh cycle. Faster rates (<14) are possible but may cause your network or processor to slow down.

---

**E1**

Please set the step count of your encoder 1 here. If the encoder provides e.g. 1440 steps, enter 1439 because the counting starts with zero.

**E1 Checkbox**

If you need to use an external index GPI switch to reset the encoder 1 counter to 0 you may check this box and enable switch S7 to be the index switch.

**E2**

Please set the step count of your encoder 2 here. If the encoder provides e.g. 1440 steps, enter 1439 because the counting starts with zero.

**E2 Checkbox**

If you need to use an external index GPI switch to reset the encoder 2 counter to 0 you may check this box and enable switch S8 to be the index switch.

**[UPDATE]:**

Press [UPDATE] to upload the new settings to the unit.

**[SAVE]:**

Press [SAVE] to store the new settings in the unit.

**[CANCEL]:**

You may press [CANCEL] at any time to leave the config mode directly.

**No access?**

If you can not access the unit anymore, press the blue reset button for 5 seconds during power on.

The unit is set by default to

IP 192.168.178.50

Subnet 255.255.255.0

Port 10001

**Important:**

To use the Sensor Link now please powercycle the unit first!

If this setup is done you can start to read out and process the data coming from the Sensor Link Device. To do this create a [Sensor Link Input Node](#)<sup>1051</sup> and route the data to any filter or output nodes.

### 7.6.3.2 STAND-ALONE SOFTWARE

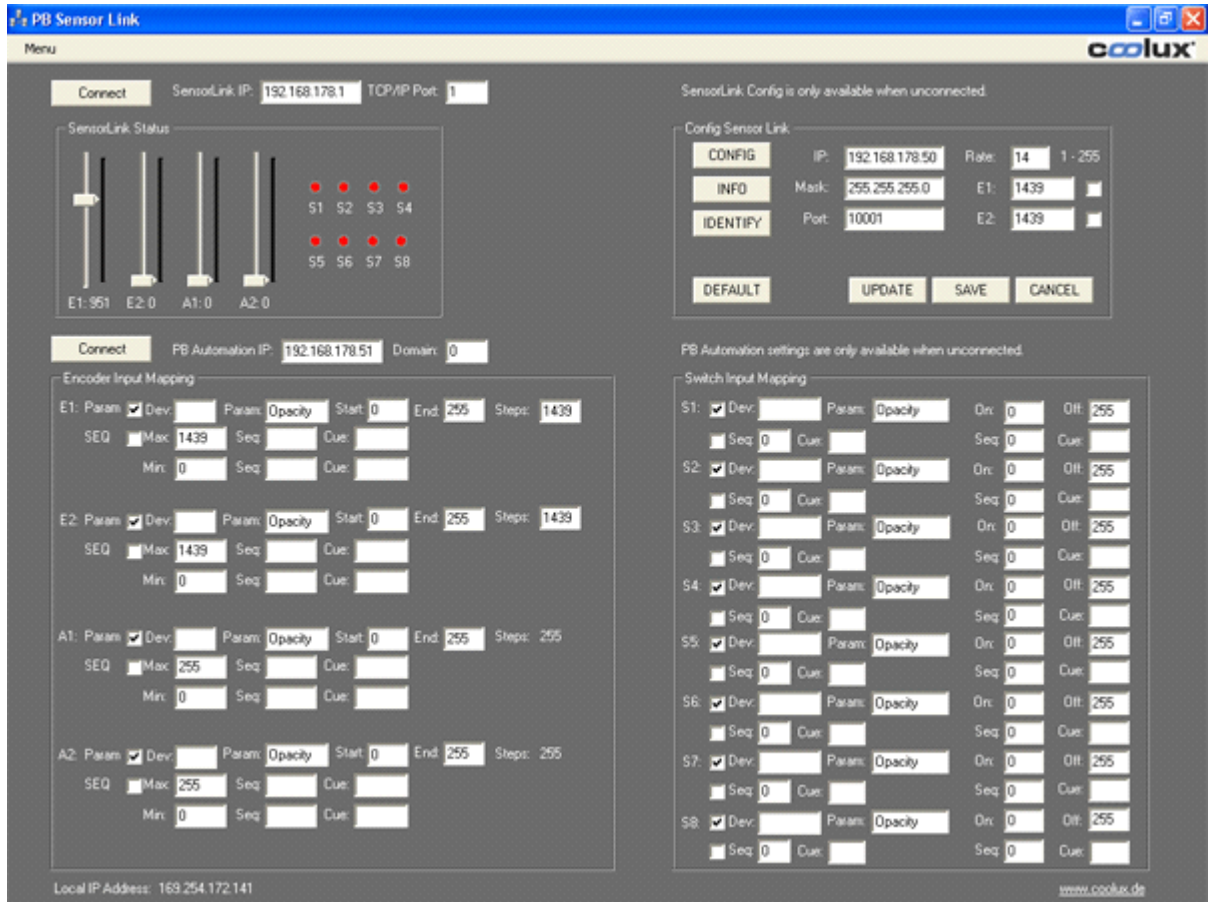

To configure the Sensor Link device, please enter the Sensor Link IP address and port in the top left fields, do not press connect at this time.

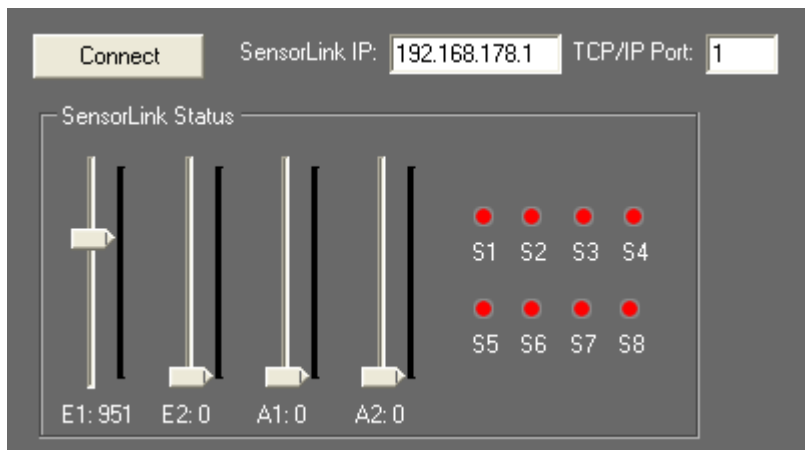

Press [CONFIG] in the ConfigSensor Link box.

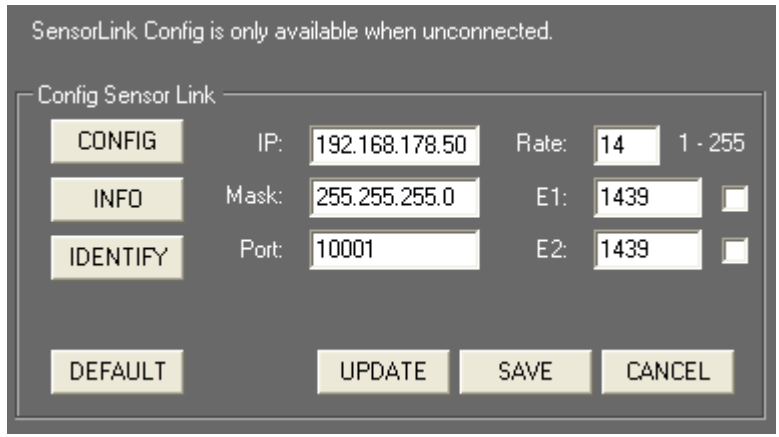

**[CONFIG]**  
When [CONFIG] is pressed the left LED will blink and the Sensor link is switched to config mode.

**[INFO]**  
Press [INFO] to retrieve the current settings of the Sensor links into the settings fields.

**[IDENTIFY]**  
Press [IDENTIFY] to identify the units, the right LEDs will blink for 3 seconds.  
Changing the Sensor Links Settings

**[DEFAULT]**  
Press [DEFAULT] to load the default settings in the settings fields.

**IP**  
Please enter the new IP address that you want to assign to the unit here.

**MASK**  
Please enter the new Subnet Mask that you want to assign to the unit here.

**PORT**  
Please enter the new TCP/IP Port number that you want to assign to the unit here.

**RATE**  
The Rate setting changes the transmission rate, the default of 14 is recommended as this is ~70 Hz refresh cycle in order to be ahead of any displays refresh cycle. Faster rates (<14) are possible but may cause your network or processor to slow down.

**E1**  
Please set the step count of your encoder 1 here.

**E1 Checkbox**  
If you need to use an external index GPI switch to reset the encoder 1 counter to 0 you may check this box and enable switch S7 to be the index switch.

**E2**  
Please set the step count of your encoder 2 here.

**E2 Checkbox**  
If you need to use an external index GPI switch to reset the encoder 2 counter to 0 you may check this box and enable switch S8 to be the index switch.

UPLOAD a new Configuration to Sensor Link

To upload new settings into the unit, press [UPDATE].

Press [SAVE] to store the new settings into the unit.  
The save process takes several seconds and will reboot the unit.

Once all LEDs light up again the unit exits config mode and is ready to being connected for data transmission.

You may press [CANCEL] at any time to leave the config mode directly.

RUN Mode

Once all settings are stored into the unit, you may connect to the Sensor Link device for data transmission by entering its IP address and port and pressing the [Connect] button.

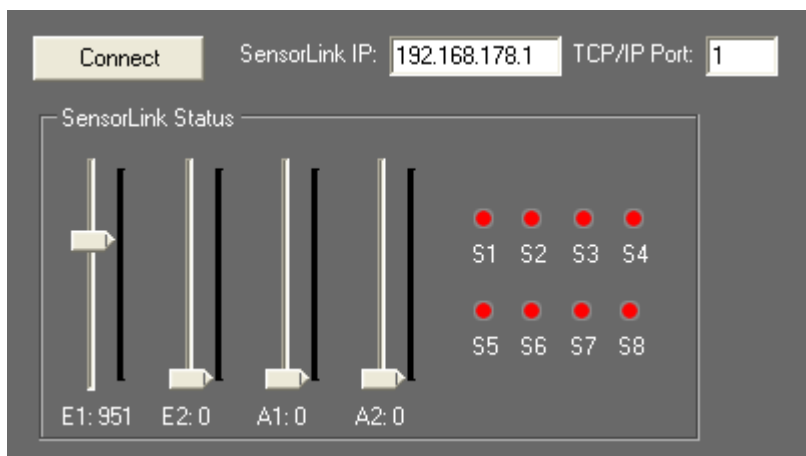

If you do not know the current IP address, you might want to use the default IP 192.168.178.50 and Port 10001.

Please note that your PC must be in the same IP address range in order to communicate with the Sensor Link Device.

Once connected, you should be able to read the incoming values in the Sensor Link Status box. To check the switches, you may want to connect the 12V pin with any of the switch pins, the switch status S1-8 will turn green once the contact is closed.

Please do not short circuit the 12V (left most pin) with the ground pin (right most pin), this might damage the unit.

Triggering Pandoras Box from Sensor Link

In order to communicate with Pandoras Box, you need to define the function of the incoming data via Sensor Link.

For each Encoder and each switch you may choose between parameter and sequence trigger mode. Use the checkboxes to set each input up for the according mode.

Encoder and Analog Inputs

Connect PB Automation IP: 192.168.178.51 Domain: 0

Encoder Input Mapping

E1: Param  Dev:  Param: Opacity Start: 0 End: 255 Steps: 1439  
 SEQ  Max: 1439 Seq:  Cue:   
 Min: 0 Seq:  Cue:

E2: Param  Dev:  Param: Opacity Start: 0 End: 255 Steps: 1439  
 SEQ  Max: 1439 Seq:  Cue:   
 Min: 0 Seq:  Cue:

A1: Param  Dev:  Param: Opacity Start: 0 End: 255 Steps: 255  
 SEQ  Max: 255 Seq:  Cue:   
 Min: 0 Seq:  Cue:

A2: Param  Dev:  Param: Opacity Start: 0 End: 255 Steps: 255  
 SEQ  Max: 255 Seq:  Cue:   
 Min: 0 Seq:  Cue:

Parameter Mode:

In Parameter Mode you may enter one or multiple devices to be linked to the incoming values.

Device Selection

To enter a single device like Server1 Layer 4 enter in the Dev field: "1,4".

To enter multiple devices, leave a space between each device like: "1,4 2,4 3,4" this setting will route all incoming data to layer 4 of machine one, two and three.

Parameter Setup

Please enter here the desired parameter name that you want to link to, like "Opacity" or "XPos".

Start and End values

Please enter here the start and end value range that you want to map your incoming data to.

Steps

Please enter the amount of steps of your connected device (for encoders only). While the Encoder Step count is determined by the hardware connected to the Sensor Link, any analog input device can be read between 0-10V with a step count of 0-255.

Sequence Mode:

In sequence mode you may enter the desired sequence and cue to be triggered above or below the incoming min. and max. values of the connected Encoder or analog input device.

Switch Inputs

PB Automation settings are only available when unconnected.

Switch Input Mapping

S1:	<input checked="" type="checkbox"/> Dev:	<input type="text"/>	Param:	<input type="text" value="Opacity"/>	On:	<input type="text" value="0"/>	Off:	<input type="text" value="255"/>
	<input type="checkbox"/> Seq:	<input type="text" value="0"/>	Cue:	<input type="text"/>	Seq:	<input type="text" value="0"/>	Cue:	<input type="text"/>
S2:	<input checked="" type="checkbox"/> Dev:	<input type="text"/>	Param:	<input type="text" value="Opacity"/>	On:	<input type="text" value="0"/>	Off:	<input type="text" value="255"/>
	<input type="checkbox"/> Seq:	<input type="text" value="0"/>	Cue:	<input type="text"/>	Seq:	<input type="text" value="0"/>	Cue:	<input type="text"/>
S3:	<input checked="" type="checkbox"/> Dev:	<input type="text"/>	Param:	<input type="text" value="Opacity"/>	On:	<input type="text" value="0"/>	Off:	<input type="text" value="255"/>
	<input type="checkbox"/> Seq:	<input type="text" value="0"/>	Cue:	<input type="text"/>	Seq:	<input type="text" value="0"/>	Cue:	<input type="text"/>
S4:	<input checked="" type="checkbox"/> Dev:	<input type="text"/>	Param:	<input type="text" value="Opacity"/>	On:	<input type="text" value="0"/>	Off:	<input type="text" value="255"/>
	<input type="checkbox"/> Seq:	<input type="text" value="0"/>	Cue:	<input type="text"/>	Seq:	<input type="text" value="0"/>	Cue:	<input type="text"/>
S5:	<input checked="" type="checkbox"/> Dev:	<input type="text"/>	Param:	<input type="text" value="Opacity"/>	On:	<input type="text" value="0"/>	Off:	<input type="text" value="255"/>
	<input type="checkbox"/> Seq:	<input type="text" value="0"/>	Cue:	<input type="text"/>	Seq:	<input type="text" value="0"/>	Cue:	<input type="text"/>
S6:	<input checked="" type="checkbox"/> Dev:	<input type="text"/>	Param:	<input type="text" value="Opacity"/>	On:	<input type="text" value="0"/>	Off:	<input type="text" value="255"/>
	<input type="checkbox"/> Seq:	<input type="text" value="0"/>	Cue:	<input type="text"/>	Seq:	<input type="text" value="0"/>	Cue:	<input type="text"/>
S7:	<input checked="" type="checkbox"/> Dev:	<input type="text"/>	Param:	<input type="text" value="Opacity"/>	On:	<input type="text" value="0"/>	Off:	<input type="text" value="255"/>
	<input type="checkbox"/> Seq:	<input type="text" value="0"/>	Cue:	<input type="text"/>	Seq:	<input type="text" value="0"/>	Cue:	<input type="text"/>
S8:	<input checked="" type="checkbox"/> Dev:	<input type="text"/>	Param:	<input type="text" value="Opacity"/>	On:	<input type="text" value="0"/>	Off:	<input type="text" value="255"/>
	<input type="checkbox"/> Seq:	<input type="text" value="0"/>	Cue:	<input type="text"/>	Seq:	<input type="text" value="0"/>	Cue:	<input type="text"/>

Switch inputs are handled similar to encoder inputs, besides the fact that you can setup only an on and off value in parameter mode. In sequence mode you may choose a sequence and cue separate for the on and off state of the switch.

Sensor Link Data Transmission to Pandoras Box

In order to connect to a Pandoras Box Master System your PC must be in the same IP address range and you will need to enter the Masters IP and Pandoras Box domain in the according setting fields and connect to Pandoras Box.

PB Automation IP:  Domain:

Please be aware that once the connection to Pandoras Box is enabled the Sensor Link user interface will pause all interface updates of faders and switch states for optimum live performance.

Resetting the Unit

To reset the Sensor Link, please press the reset button on the rear side of the unit and hold it for 5 sec while power-cycling:

Power off the Serial, press the reset button, power it on again and hold the button for 5 sec pressed.

When the unit is reset the following settings will be set:

IP: 192.168.178.50

Subnet-Mask: 255.255.255.0

Port: 10001

---

Troubleshooting:

Problem: The incoming data comes in slowly and does not update fast enough.

Solution: Press cancel to exit config mode and reconnect to the Sensor Link unit or power-cycle the unit to exit config mode as well.

Problem: You caused a short circuit because of connecting Pin 12 (+12V) and Pin 1 (Ground).

Solution: There is an internal fuse inside the Sensor Link that has to be replaced. Please contact [support@coolux.de](mailto:support@coolux.de)



## 7.7 SERIAL LINK

**Please note, that coolux has discontinued the Serial Link. Please refer to [JLCooper Electronics](#) and their product [eBOX](#).**

The Serial Link is a general purpose interface box that converts 4 serial communication ports and 24 GPI (General Purpose Interface) inputs and outputs to 100/10baseT Ethernet. The serial ports can be configured in the field to appear as EIA/TIA RS-232E and CCITT V.28 or as EIA/TIA RS-422A, RS-423 and Federal Standards 1020 & 1030 ports. Additionally, the port direction can be configured as DTE or DCE on each port independently.

The Serial Link communicates over standard TCP/IP which allows it to be used with any host computer running any operating system that uses TCP/IP protocol. The Serial Link can also be connected to other Serial Links to allow longer runs than traditional serial and GPI cables. Since the Serial Link uses TCP/IP, traffic can be routed over internal LANs, wireless LANs, MANs, WANs and even over the public Internet.

Most configurations can be accomplished through a web page server built into the Serial Link. Items such as port speed, parity, IP address, remote IP address and TCP port are set using a standard web browser. Settings are stored in nonvolatile memory.

Typically, the Serial Link functions as a Server, passively waiting for Client devices to connect to it. The device can be a computer or another Serial Link configured as a client. When the Serial Link is configured as a Client, it will actively attempt to connect to the Server Serial Link. Once this is accomplished, the Serial Link will either pass data received in the serial or GPI ports to the remote Serial Link. If there is no data received in the Serial Link, the Serial Link will not send any TCP packets.

In addition, the Serial Link can operate as a GPI to Serial Converter or GPI to Ethernet Converter. In these modes, the Serial Link will convert GPI input triggers to deck commands.

### SERIAL LINK SETUP

The serial control will give you access and control to most routing switchers, projectors, shutters or other device parameters that are remote controllable via the common RS 232 and 422 serial protocols.

In order to control external serial devices over RS 232 or RS 422 you will need to add a serial link device to the device tree. Any serial ASCII or hex string can be stored and copied to any point in the timeline and be recalled at any time the time cursor hits the stored serial key. Once you set the first key you can assign the IP address and port ID in the keys properties as well as the ASCII or hex command for that key.

You will need a serial link device to receive and output serial commands. See further instructions in the serial link manual for port setting baud rates and parity settings.

Please find below the .clib code for the basic Serial Link device:

```
<?xml encoding="yes" ?>
<descripDevice type="fixtureSerial" artNetIndexScope="1">
<descripModule type="paramSerial" name="Com" default="0" artNetIndexOff="0" />
</descripDevice>
```

### Connections

The Serial Link connections are straightforward:

1. Plug the power supply into the Serial Link.
2. Plug a network cable into the Ethernet jack.
3. Connect serial cables into ports 1-4.

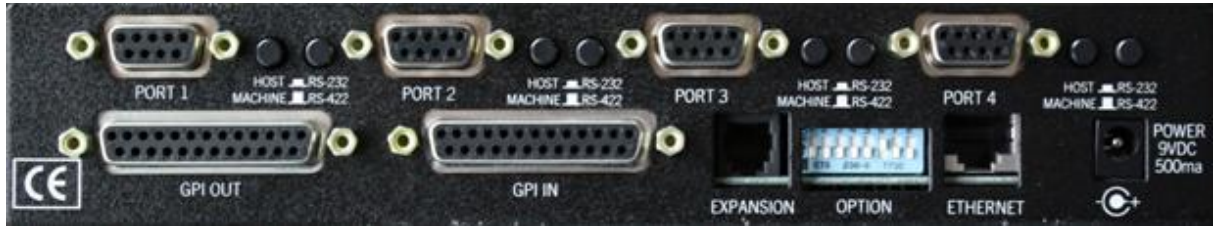

The rear side

ETHERNET

This Serial Link port is just like an Ethernet port on a computer, to connect it to a hub, switch or router, use a straight through cable. To connect it to another Serial Link or computer, use a crossover cable.

The Serial Link supports IEEE 802.3u clause 28 Auto-Negotiation which automatically senses the Ethernet port speed & duplex operation and chooses the highest performance settings.



The front panel

Four LEDs on the front panel indicate various operating conditions of the Ethernet port. These LEDs are:

- Link
- 100BaseT activity
- 10BaseT activity
- Collision

CONFIGURATION

Operating Modes

The Serial Link has five distinct modes of operation that are set by the rear panel DIP switches. The DIP switches are read only at power on so the Serial Link must be power cycled for the changes to take effect.

SW8	SW7	SW5	
On	X	Off	Access web page at 192.168.254.102
Off	Off	Off	Serial Link is server at address specified on next page
Off	On	Off	Serial Link is client at address specified on next page
Off	On	On	Serial Link performs GPI to serial conversion
Off	Off	On	Serial Link performs GPI to Ethernet conversion
X = Don't care			

Configuration Mode

On the Configuration Web page, various settings such as port rate and parity, IP addresses and ports, and password can be modified.

**Note: The Serial Link will not send Serial/GPI messages when the Serial Link is set to configuration mode.**

To access the Configuration Web Page of the Serial Link Device, please set SW8 and SW6 to ON and all others to OFF. The PC Firewall and an Antivirus system have to be turned off!

This page is accessed by setting SW8 to the 'On' position and typing "http://192.168.254.102" into your web browser (use Internet Explorer, Safari and Firefox do not work). During this time, the normal operation of the Serial Link is suspended.

**Note: The configuration web page is always set to 192.168.254.102 regardless of the state of the DIP switches.**

Note: In the configuration mode, the subnet mask is set to 255.255.255.0. This means that the Serial Link will only see traffic from computers with an IP address of 192.168.254.nnn. You will need to change your computer's IP address to 192.168.254.nnn where nnn = any number except 0, 102 and 255. This will allow your computer to access the configuration page of the Serial Link.

Make any changes that are necessary for your system and click on SUBMIT. These changes are stored in non-volatile memory and are loaded at power up.

Default settings: Timeout = 100ms and max buff size = 255.

A Page with a Pink background should now be loaded into Internet Explorer to tell you to power cycle the unit, but first:

- Switch DIP8 to OFF position.
- Wait approx 10 – 15 sec !
- Now power cycle the Serial Link!

To verify the Settings:

- Power Off Serial Link
- Set DIP 8 to ON again
- Power Cycle the Serial Link
- Launch internet explorer and make sure to empty the browser cache by clicking on Safety -> Delete Browsing History... -> check all check boxes and click on the delete button
- Now type in 192.168.254.102 in the address field of Internet Explorer.

To use Serial Link with a custom IP address please make sure to set DIP 1,2,3 to ON and 8 to OFF

DIP 6 should always remain in the ON position as this disables the internal password protection that is currently not used.

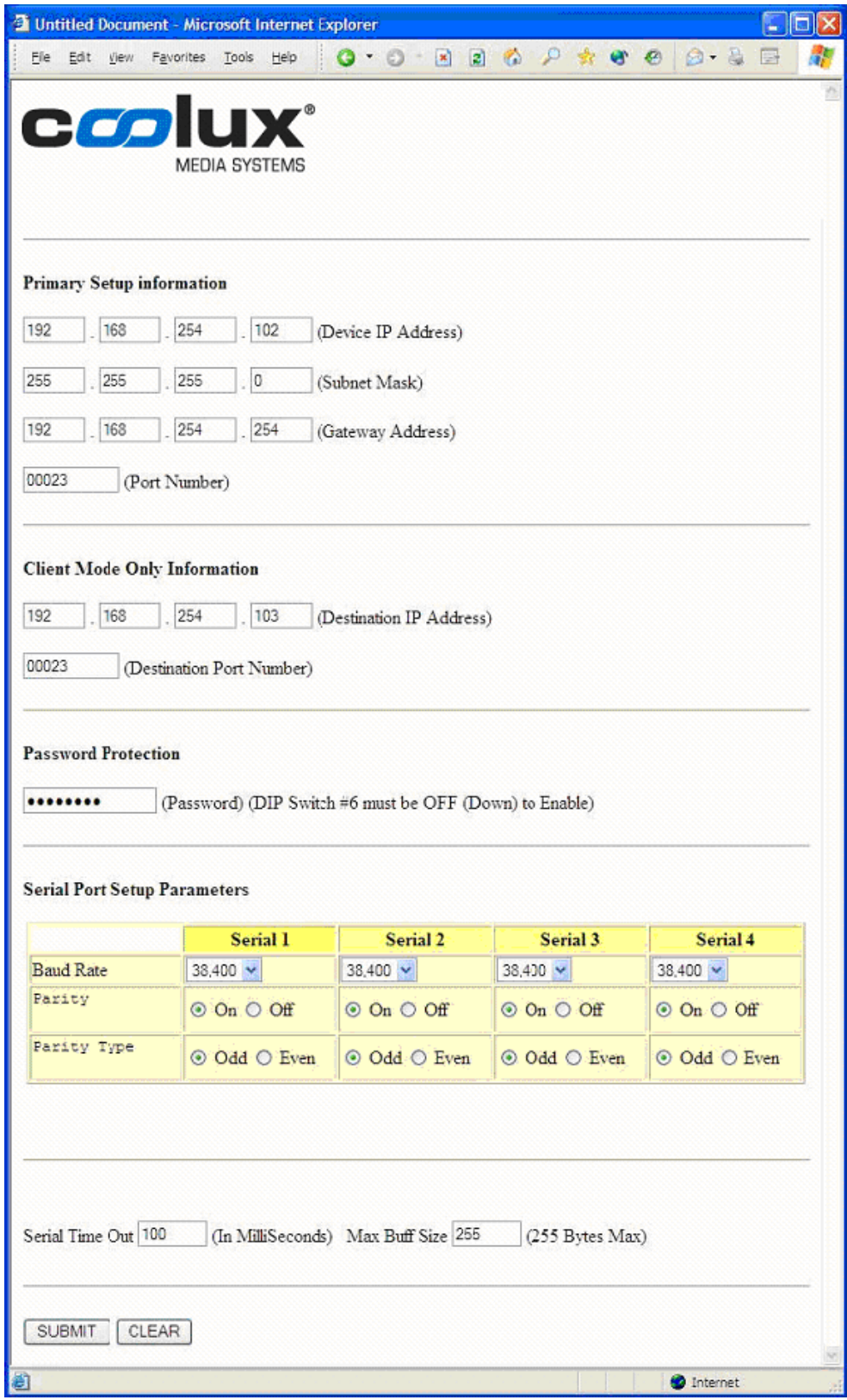

Image: Configuration Web Page

Operational Settings

Device IP Address:  
 IP address of this Serial Link when SW1, SW2 and SW3=On.

**Subnet Mask:**

The mask is a binary pattern that is matched up with the IP address to turn part of the host ID address field into a field for subnets.

**Gateway Address:**

IP address of gateway router which connects to other networks.

**Port Number:**

TCP port of this Serial Link when SW1, SW2 and SW3=On.

**Destination IP Address:**

IP address of remote Serial Link when SW1, SW2 and SW3=On. This is used when Serial Link is configured as a client (SW7=On).

**Destination Port Number:**

TCP port of remote Serial Link when SW1, SW2 and SW3=On. This is used when Serial Link is configured as a client (SW7=On).

**Password:**

Eight character alphanumeric password that is embedded in the Ethernet packet that prevents unauthorized Serial Links from passing unintended packets. Both Serial Links must have the same password and have password protection turned on (SW6=Off) for this feature to work.

**Baud Rate:**

Sets the port speed of the individual serial ports.

**Parity and Parity Type:**

Enables or disables parity and sets parity type of the serial ports.

**Serial Time Out:**

Sets the time that the Serial Link will wait for data from the serial ports.

**Max Buff Size:**

Sets the maximum buffer size of the serial ports.

**Serial Link IP Address:**

The IP address of the Serial Link can be set by the rear panel DIP switches or by the internal web page. As above, the DIP switches are read only at power on so the Serial Link must be power cycled for the changes to take effect.

Here is a table of how IP address and the TCP port are set with the DIP switches in Serial Link Server and Serial Link Client modes.

SW3	SW2	SW1	SW7	Mode	IP Address	Port
Off	Off	Off	Off	Server	192.168.254.102	23
Off	Off	On	Off	Client	192.168.254.103	23
Off	Off	On	Off	Server	192.168.254.104	23
Off	Off	On	On	Client	192.168.254.105	23
Off	On	Off	Off	Server	192.168.254.106	23
Off	On	Off	On	Client	192.168.254.107	23
Off	On	On	Off	Server	10.0.0.128	23
Off	On	On	On	Client	10.0.0.129	23
On	Off	Off	Off	Server	10.0.0.130	23
On	Off	Off	On	Client	10.0.0.131	23
On	Off	On	Off	Server	10.0.0.132	23
On	Off	On	On	Client	10.0.0.133	23
On	On	Off	Off	Server	172.16.0.128	23
On	On	Off	On	Client	172.16.0.129	23
On	On	On	Off	Server	Set by user	
On	On	On	On	Client	Set by user	

IP Address Configuration for Serial Link Server and Serial Link Client modes

Electrical Connections

Power

The Serial Link requires a 9 volt DC supply capable of delivering at least 500 milliamps. The unit comes with a power supply appropriate for the country in which the unit was sold. If you need a power supply specific to your location, please contact your local distributor or coolux.

Warning: Using a power supply other than the units specified in the above table can result in damage to the Serial Link and/or other equipment which is not covered by the coolux warranty.

## 7.8 SMPTE LINK

All Pandoras Box Manager, Server or Player products with timelines can send and receive LTC SMPTE via the USB SMPTE Link interface.



To connect the SMPTE Link please refer to the [Configuration tab](#)<sup>139</sup>, section [SMPTE Time Code](#)<sup>157</sup>. Afterwards, the [Sequence Inspector](#)<sup>200</sup> allows to set up the "Mode", "Offset" and "Stop Action".

The SMPTE Link Interface provides balanced signal transmission:

- Pin1: ground
- Pin2: signal
- Pin3: signal

It does not matter which signal is +/-.

## 7.9 DMX LINK



The DMX Link is a DMX - USB interface offering an easy setup for DMX 512 control.

All Pandoras Box Manager, Server or Player products with timelines can send or receive DMX data. There are two versions available, the DMX Link In and the DMX Link Out. Please note that it is not possible to use gender changer adapters to turn the signal flow!

The DMX Link In allows to remote control Pandoras Box via a DMX device. In other words, it provides direct sequence and layer control from any common lighting controller.

Connect the DMX Link to your master system, e.g. a PB Manager, Server or Player. In case of remote controlling clients, drag them from the [Asset tab](#)<sup>137</sup> or [Device Types tab](#)<sup>181</sup> into the [Device Tree tab](#)<sup>168</sup>. Patch the layers in the [Patch tab](#)<sup>222</sup> to the according channel, subnet and universe. There is no need to have another DMX-Link connected to a client, it is controlled by the master. Activate the DMX input in the [Configuration tab](#)<sup>139</sup> and as soon

as data is sent to the master system, all patched layers or sequence parameters are remote controlled.

The DMX Link Out allows to remote control DMX devices with Pandoras Box. It is mostly used to control moving lights, spots etc. with the Pandoras Box timeline for a synchronized video and light show.

Connect the DMX Link to your master system, e.g. a PB Manager, Server or Player. Drag the built-in or custom designed DMX devices from the [Device Types tab](#)<sup>181</sup> into the [Device Tree tab](#)<sup>168</sup>. Patch the layers in the [Patch tab](#)<sup>222</sup> to the according channel, subnet and universe. Activate the DMX output in the [Configuration tab](#)<sup>139</sup> and as soon as a key is stored in the [timeline](#)<sup>260</sup>, the DMX data will be sent constantly to the devices. Only changes to DMX values will be sent. Resetting a DMX node will send all values at once.

Please be aware that a single USB DMX interface will allow you to control a maximum of 512 DMX channels on subnet 0 and universe 0.

LED Status:

magenta	no driver found; please install the current <a href="#">coolux driver for USB devices</a>
blue / magenta pulse	the driver is in idle state; please start a Pandoras Box Master software and setup to receive or send data as described above if using a DMX Link In, this status means that the connection between the DMX Link and PB software is not setup
blue / red pulse	only for DMX Link In; in contrast to the above, this status means that the connection between the DMX Link and the sending device is not alright
blue blinking	ok, the DMX Link is sending / receiving data

### 7.10 DMX LINK 8

**Please note, that coolux has discontinued the DMX Link 8. Please refer to [ELC](#) and their product [dmXLAN Node 8GB](#).**

The DMX link 8 converts up to 10 DMX universes to Ethernet (Art-Net protocol). Backwards, 8 DMX universes can be converted from Art-Net to DMX.

Furthermore it can be used stand alone as a universal programming digital merger (ex. 2 in 8 out) or splitter (ex. 2 splitters of 1 in to 4 out). Saving the lastly received signal DMX signal in the unit, it also acts as a perfect backup (ex. 4 in 4 out).

#### FEATURES

- Remote programming and monitoring
- DMX input options like Normal or Backup
- DMX output options like Normal, Merging in HTP/LTP or custom /Priority merging, Merging with channel by channel softpatch
- Remote takeover of fixture parameters



- Visualizer input support like WYSIWYG, ESP, Capture and many others

HARDWARE DESCRIPTION

Front Panel



The front panel has a graphic LC-display, 3 keys and a jog-encoder with push function and 3 LEDs.

Connections at the back



The dmXLAN node8 has many connectivity options. Viewed at the back from left to right:

RS-232 (top SUB-D 9pin)	Pin	Description
To connect the RS-232 port to a PC you'll need a 1 to 1 male/female sub-d 9pin cable. (NO null-modem / cross cable)	1	-
	2	TX
	3	RX
	4	-
	5	Ground
	6-9	-
Contact Closure Inputs (bottom SUB-D 9pin)	Pin	Description
These inputs have an internal pull-up resistor. A simple switch can be connected between the input pin and a ground pin. The contact inputs can be used to temporarily recall a patch setting.	1	Ground / Shield
	2	Input 1
	3	Input 2
	4	Input 3
	5	Input 4
	6-9	Ground
Network 10/100 MBit Ethernet (on Neutrik Ethercon)		
The network connection uses a standard UTP network connection.		
USB 2.0 Full-speed		
The USB connection uses standard USB pinout.		
DMX port 1 – 8	Pin	Description
The DMX ports 1 to 8 are bi-directional(via programmable setup), have an internal terminator resistor and are RDM prepared.	1	Ground / Screen
	2	Data -
	3	Data +
	4	-
	5	-

DMX port 9 and 10	Pin	Description
DMX ports 9 and 10 are fixed DMX inputs and have a fixed internal terminator.	1	Ground / Screen
	2	Data -
	3	Data +
	4	-
	5	-

There are 2 versions of node8 available, the normal and the Full Isolated (FI). The full isolated version has an optical/galvanic isolation barrier on all DMX ports (up to 1500V).

CONTROL THROUGH FRONT PANEL

Main Display



A Select config menu, to recall 1 of 4 previously saved configurations (patches)  
 B View DMX values  
 < (Setup) Enter setup menu  
 Encoder +/- Select information displays

INFORMATION DISPLAYS

DMX port status

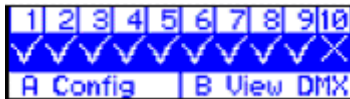

x > port does not receive data (or DMX when input)  
 v > port receives data (or DMX when input)

ID setting



IP address

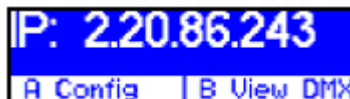

Version and serial number

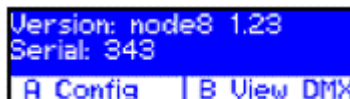

This product may only be used for controlling dimmers and moving lights. Using the product out of these specifications will remove all responsibility from the supplier

Configuration Menu



From the main display press A (config). Now you can either recall a previous setup or store the current one in one of the 4 options. Use the encoder to select a setup:

- Press A to load the selected configuration
- Press B to store the current configuration
- Press \_ to cancel the operation

The 4 contact closures on the back can be used to temporarily recall any of the 4 setups. The configuration is loaded on closing the contact and the normal configuration is loaded when the contact is opened. Contact closure 4 has the highest priority. Any change to the configuration, either thru the menu or via remote software (dmXLAN) is stored in the temporarily selected configuration.

DMX View Menu



small bars (120ch)

large bars (40ch)

decimal (6ch)

From the main display press B (View DMX). Now you can view the DMX values of each port (input or output). Use the encoder to change the channel:

- Press A to select a different port
- Press B to change the view mode
- Press < to exit

Setup menu

Enter the setup menu from the main screen by pressing <



By using the encoder select the item you would like to adjust.

Options:

- Edit DMX port 1 to 8 or DMX input 9 and 10
- Set the ID
- Rename the current configuration
- Change network settings (IP address and netmask)

Edit the item by pressing A or the encoder.

All settings will be stored AFTER exiting the setup menu via the < key, a message will appear.

Edit DMX ports 1 to 8 or DMX input 9 and 10

Use the encoder to change the current selected option and press the encoder to select the next option.

- Press A to store the configuration
- Press B to set the DMX port to it's default value
- Press < to cancel any changes

DMX port as output

When a port is set up as a DMX output, then you can select the working mode of that port.

Modes are:

- disabled > the DMX output is disabled
- outzero > the DMX sends out a DMX test signal with all channels at 0%
- single > the output sends out the DMX values of the selected (primary) Art-Net universe. The DMX output is enabled the first time when it detects the DMX universe on the network (or internal DMX inputs). If the universe on the network fails, the DMX output will go into DMX hold.
- dual HTP > like single, but merge two DMX universes (primary and secondary) in highest take precedence.
- dual LTP > like dual LTP, like dual HTP but in latest takes precedence (on a channel by channel basis)

DMX port as input

When a port is set up as a DMX input, it can be operated in the following modes.

- disabled > the DMX input does nothing
- normal > any valid DMX is sent onto the network (and internal use) using the

selected universe (Art-Net)

· backup > the DMX input will not send data if the selected universe is present on the network. If the selected universe is not present on the network for several seconds and the input has valid DMX, then it will send DMX data. If another sender starts sending the same universe, the input will go back input backup mode. Please note. DMX input 9 and 10 are always fixed to work as input.

Set ID



Used the encoder to change the current selected digit, and press the encoder to select the next digit. The digits are in hexadecimal (16 possibilities 0-9, A-F). This means you can have up to 4095 different IDs in the system (ID 000 means that the ID is not used).

Press A to store

Press B to disable (---)

Press < to cancel the operation

Rename current configuration

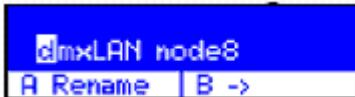

The name of the current configuration is presented in the main display and in the dmXLAN software. The name is also used to indicate the configuration setting when it is stored in one of the 4 built in configurations.

Use the encoder to change the current character, and press the encoder to select the next.

Press A to store the name

Press B to select the next character

Press < to cancel the operation

Network settings

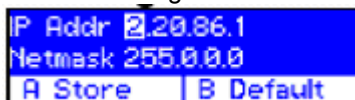

Use the encoder to change the current parameter, and press to select the next.

Press A to store the configuration

Press B to select the factory default IP address and Netmask

Press < to cancel the operation

## GENERAL INFORMATION

CE – Product

The DMXLink 8 permits to the CE requirements set up by the European Community. This can be recognized by this label on the outside of the product.



Technical Specifications:

Power: 85-264 VAC 47-440 Hz 10VA max  
Dimensions 19" 1HE rack unit 483 x 44 x 150 mm  
Weight 2kg

## 7.11 EDID LINK



### Overview

The EDID Link is a device to manage DVI-EDIDs and communicate these to the graphics card. EDIDs (Extended Display Identification Data) are used to describe the (preferred) timing of a display device. The timing is describing the display's resolution and its sync pixels. It is communicated to the graphic source via the DVI-cable.

The EDID Link can be used to generate and constantly hold an EDID whenever a display device is not able to send a correct or the exact needed EDID to the source. In addition the EDID Link will ensure, that a monitor is simulated even when none is connected to it, or powered down. The EDID Link does not need any separate power as it receives the voltage from the graphics card.

The EDID Link handles DualLink-DVI-I signals and creates / emulates DVI-EDIDs. Analog signals will be routed through. The device is not HDCP compliant.

### Features

Per default, the EDID Link comes with preinstalled EDIDs and can be used without additional software. The [hardware features](#)<sup>742</sup> are explained in the following chapter. In short, it allows to:

- select an EDID via a preset
- work in transparent mode to route the display device's EDID information to the graphics card

For more advanced users, the EDID Link offers an [additional software](#)<sup>744</sup>. In short, it allows to:

- read out a display's EDID or load it from a file
- create an entirely new EDID
- modify EDIDs
- write this EDID to one of the user presets or to a file

## 7.11.1 EDID LINK HARDWARE

This chapter explains the features of the EDID Link's hardware. The previous chapter offers [general information about the EDID Link](#)<sup>741</sup> whilst the next covers its [software features](#)<sup>744</sup>.

### Presets

With its two selection knobs, you can select from up to 99 different EDIDs directly. Presets 01-49 are holding read-only default EDIDs while presets 50-99 can be configured by the user. All EDIDs can be exported to a file to be used on a different system, such as the Pandoras Box Quad Server with its [DVI Processor](#)<sup>662</sup>.

Preset 00 acts like a “transparent mode” which will route through the EDID coming from the connected display device. More than that, the last seen, valid EDID is stored to preset 00. Therefore you can disconnect the display while the graphics card will still see the display's information. Whenever a different EDID is transferred into the device, this information will be written into preset 00, even while emulating another preset at that time.

In order to read out a new EDID, the EDID Link needs to receive 5V either coming from the graphics card, or the USB-plug. With any 5V input connected, you may read out and store the display's information to preset 00 and later on edit it or download it to your computer using the [software "EDID Link Editor"](#)<sup>744</sup>.

### Usage

Your EDID Link is directly ready to use. You do not need any installation in order to use the default EDIDs. A list is printed onto the device and is part of the delivered documentation.

- Power down your signal source (e.g. a computer) first.
- Connect the EDID Link's DVI “in” connector with the included short DVI cable to the graphics card's output of your signal source.
- Connect the EDID Link's DVI “out” connector to your display device (e.g. a monitor).
- Select the desired EDID by rotating the selection knobs.
- Power up your signal source.

The signal source will now receive the EDID adjusted on the EDID Link. You may need to select and confirm to change to this resolution using the graphics card driver. From now on, there is no direct connection from the graphic source to the display any longer. Therefore, you may power down the display without losing your graphics card settings as the EDID Link is still emulating the device. Even a loose connection of the DVI cable will not harm the settings any more. When using presets other than 00, you will be able to switch display devices without transferring this information to the source.

**It is recommended to power down the complete system before disconnecting a DVI cable.**

Rotating the selection knobs while running the system will lead to a disconnect of the attached EDID Link and the graphics card. It may switch to a not connected state. As long as you turn the knobs, the EDID Link remains in the disconnected state. After two seconds of not changing the preset, the device will output the selected EDID. You may need to set the resolution again within your graphics cards settings or source device settings.

## LED Codes

The LED next to the USB plug features different LED codes:

- Red blinking the device is in firmware programming mode
- Blue pulsing to magenta every 5s the device is idle and ready to use
- Blue switching once off for 0,5s the device is used by the software to read from or write to a preset

## Important information about internal EDID handling

EDIDs (Extended Display Identification Data) are used to describe the (preferred) timing of a display device. The timing is describing the display's resolution and its sync pixels. It is communicated to the graphic source via the DVI-cable.

A single EDID may feature a list of different timings which can be processed by the monitor. This may be a combination of "Established Timings", "Standard Timings" and "Detailed Timings" at the same time. This gives the user the flexibility to choose from more than one resolution, whenever the native one is not about to be used.

As this flexibility often leads to not having the desired resolution set within the signal source, the EDID Link limits all its EDIDs to only one single timing.

Using this fact, the graphics card will be forced to output the exact desired resolution and timing.

**Note: All default EDIDs as well as imported or read out ones from any device are changed and limited to the "First Detailed Timing Descriptor". Extensions are being cut off as well as soon as they are stored into the EDID Link.**

As preset 00 acts as a transparent mode, you will find the original EDID including all timings and extensions. Storing this data into a preset will reduce the timing to a single one. How to do this is explained in the next chapter covering the [EDID Link's software](#)<sup>744</sup>.

### 7.11.2 SOFTWARE - EDID LINK EDITOR

This chapter explains the features of the EDID Link's software. The previous chapters offer [general information about the EDID Link](#)<sup>741</sup> and cover its [hardware features](#)<sup>742</sup>.

#### Installation and Software

Run the "EDID Link Editor Installer" on a Windows operating system and proceed through the installation. The installer is available on the delivered CD or in the coolux [Download-Center](#). After the installation you will find the EDID Link Editor software within the Windows start menu and a shortcut on your Desktop.

The EDID Link Editor software can be used with or without a connected EDID Link to create, edit or organize EDIDs.

If you like to read an EDID out or write presets onto it, connect your EDID Link via the included USB-cable to your computer. Use the [USB-driver](#) "coousb-driver v6.0.13.0" (or a newer one) to finish the hardware installation of the device. The EDID Link is now communicating with your system and ready to be used.

The software is divided into three sections as pictured below.

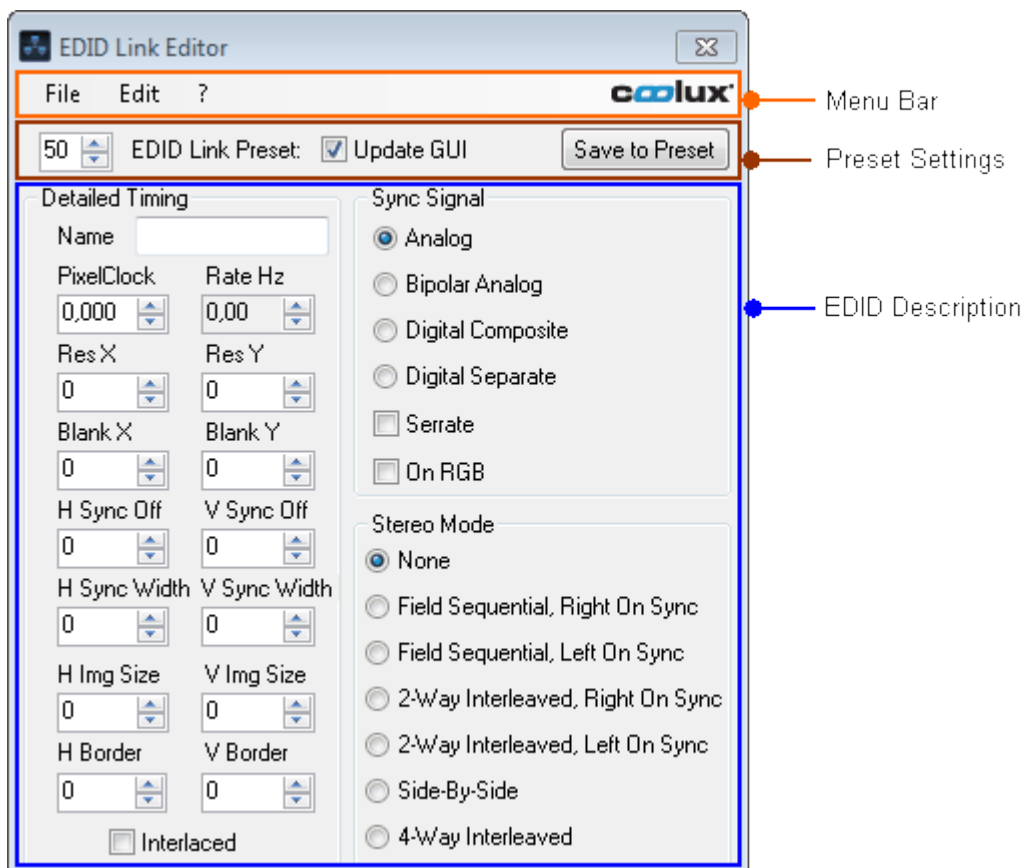



---

## Menu Bar

### File Menu

Use "Load EDID File ..." to load a stored EDID into the Editor. You can then edit and store this EDID to an EDID Link preset or export it into a file again.

Use "Save EDID File ..." to export the currently displayed EDID timing into a file.

### Edit Menu

Use "Read Monitor EDID" to force the EDID Link to read the currently connected EDID (again) and display it within the Graphical User Interface (GUI). If no valid EDID can be read, all values will equal zero.

Note: If you want to read out what has already been stored automatically to preset 00 when the monitor has been attached, you can recall preset 00 without using this menu item.

Use "Initialize Default EDID List" in order to re-initialize the default EDIDs on all presets.

**Note: This action will overwrite all user data.**

## Preset Settings

Use the "EDID Link Preset" numeric box in order to recall the particular preset 00-99 by either clicking up/down or typing in the desired preset number followed by the return key.

Choosing a preset will read out its content stored within the EDID Link and display it in the "EDID Description" section.

Check the "Update GUI" check box in order to directly recall content from a preset while changing the preset number. You may uncheck the check box in order to select a preset without loading its content (and overriding your changes done in the EDID settings).

Use the "Save to Preset" button in order to store the currently displayed EDID timing into the selected preset. You may want to uncheck the "Update GUI" check box in order to select a preset you want to overwrite without losing your settings entered in the "Detailed Timing" settings below.

## EDID Description

The EDID Description shows the content of the "First Detailed Timing Descriptor Block" along with the "Monitor Name" out of the EDIDs "Descriptor Block 2".

The displayed information can be edited and stored to the EDID Link or to a file as described above.

**Detailed Timing**

Name	Read out or change the monitor name with a maximum of 13 characters.
PixelClock	This value shows the signal's PixelClock in MHz. The maximum value is 330.
Rate Hz	This value shows the signal's Refresh Rate in Hz when an EDID is loaded. It results of all other definable settings regarding pixel count and PixelClock.
Res X	This value shows the signal's active pixel per horizontal line. Active pixels are the shown ones within a display device and equal the horizontal resolution. The maximum value is 4095.
Res Y	This value shows the signal's active lines per image. Active lines are the shown ones within a display device and equal the vertical resolution. The maximum value is 4095.
Blank X	This value shows the signal's total horizontal blanking pixels including (definable) front porch, (definable) sync width and (resulting) back porch. The combination of the horizontal active, blanking and border pixels equals the picture's horizontal total pixels. The maximum value is 4095.
Blank Y	This value shows the signal's total vertical blanking lines including (definable) front porch, (definable) sync width and (resulting) back porch. The combination of the vertical active, blanking and border lines equals the picture's vertical total lines. The maximum value is 4095.
H Sync Off	This value shows the signal's horizontal sync offset (front porch) in pixels. The maximum value is 1023.
V Sync Off	This value shows the signal's vertical sync offset (front porch) in lines. The maximum value is 1023.
H Sync Width	This value shows the signal's horizontal sync width in pixels. The maximum value is 1023.
V Sync Width	This value shows the signal's vertical sync width in lines. The maximum value is 1023.
H Img Size	This value shows the monitor's horizontal image size in mm. This information value is optional and has no influence on the signal processing. The maximum value is 4095.
V Img Size	This value shows the monitor's vertical image size in mm. This information value is optional and has no influence on the signal processing. The maximum value is 4095.
H Border	This value shows the signal's horizontal border in pixels. The maximum value is 255.
V Border	This value shows the signal's vertical border in lines. The maximum value is 255.
Interlaced	This check box shows if the signal is interlaced (checked) or progressive (unchecked).

**Sync Signal**

Readout or select the desired sync option required by the signal.

Depending on the chosen sync option, there are additional check boxes to be de-/activated.

**Stereo Mode**

Readout or select the desired Stereo Mode required by the signal.

## 7.12 NET LINK AND CALIBRATION LINK



The NET Link is a modifiable interface device build to:

- provide sensor information as input signals to [Widget Designer](#)<sup>[864]</sup> or the [Warper](#)<sup>[780]</sup> and / or
- control relays by sending output signals.

Through these programs sensors can control layer and sequence parameters in [Pandoras Box](#)<sup>[94]</sup>. In return, Pandoras Box can trigger the devices too.

The [hardware features](#)<sup>[747]</sup> are explained in the following chapter in detail. In short, the NET Link is a customizable device and comprises:

- a housing: choose between the small chassis depicted above or the 19" rack module
- min. one processor unit
- changeable boards: coolux delivers the NET Link ready-to-use as ordered by you. However, you may modify the NET Link by changing the boards at any time. Currently, seven boards are available covering analog and digital boards as well as input and output ones. [Show examples...](#)<sup>[750]</sup>

The Calibration Link is a small NET Link device equipped with two analog fibre input boards for the input of 16 fibre cables (single-core, diameter of 0.98mm<sup>2</sup>). It is specially designed for an automated re-calibration of a projection setup, e.g. in a fixed installation where a projector or a screen have been moved. [Show example...](#)<sup>[750]</sup>

The NET Link supports a sensors range from standard industrial encoders, distometers as well as analog potentiometers and contact closures to specially designed Phidget sensors or self-build solutions. As long as a sensor can be connected to one of the offered boards, meaning that it meets the technical specifications, its data can be send to Widget Designer. More details regarding the [software](#)<sup>[753]</sup> are included on the following pages.

### 7.12.1 NET LINK HARDWARE

This chapter explains the hardware of the NET Link. Please see the [introductory chapter](#)<sup>[747]</sup> for other information.

As mentioned in the previous overview chapter, the NET Link is a customizable device. Choose between two housings: a small 4 slot high housing or a larger 21 slot wide housing. At least one processor unit is needed, it takes up the space of 2 slots. You may then choose from six boards, each 1 slot: analog / digital and input / output ones.

Both editions are powered with 12V. The AC adapter has an input of 110-240V, max. 1.2A and an output of 12V, 7A via a 4pin-XLR plug.

The allowed voltages and ampere for sensors depend on the board. Some boards do not provide power for the connections, thus an external power supply is needed!

## The housing & power supply

In general the NET Link comes in two editions regarding its housing. The above mentioned power supply is the same for both.

### Small edition, e.g. for rental purposes

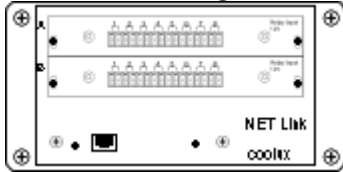

The first housing is a smaller case. Its dimensions are H: 85mm, W: 172.1mm, D: 121mm. It is 4 slots high. The modules are mounted horizontally.

Inherently, it comes with one processor unit (2 slots high) that cannot be removed. There is space for two boards.

### Larger edition, e.g. for fixed installations

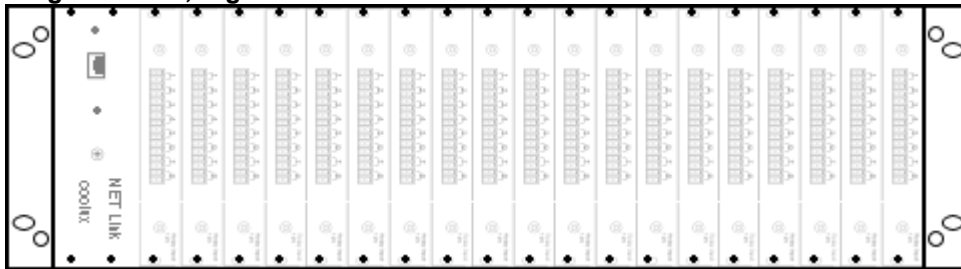

The second housing is a 19" rack housing which is 3 rack units high (H: 133.35mm, W: 482.6mm, D: 183mm). It is 21 slots wide. The modules are mounted vertically.

The rack housing does not include a processor unit per se. In difference to the small housing, the 19" housing can contain more than one processor (2 slots). If only one is chosen, up to 19 boards (each 1 slot) can be mounted.

## The processor unit

The processor is the part of the NET Link responsible for the communication to connected [software](#)<sup>753</sup> ([Widget Designer](#)<sup>864</sup> or [Warper](#)<sup>780</sup>). It takes up the space of two slots and consists of:

- a network plug with a network adapter that can be set to any IP address and port number
- a "Reset" button to apply the default IP address (192.168.178.222), subnet mask (255.255.255.0 and 5000). To reset the device, hold the reset button down whilst recycling the NET Link, i.e. re-connecting the XLR power plug at the back.
- a "Run" LED indicating the status of the unit. The green LED blinks once a second if everything is alright and network packages are sent correctly. If the flashing is slower, the processor unit does not perform properly because network packages can not be sent in the expected way. This could be caused by a faulty network environment like cables, switches or IP settings. Please check the status after approx. 100 seconds after establishing the communication between the NET Link and Widget Designer.

In addition it manages the connected input / output boards. The processor has four connectors: A1, A2, D1 and D2, available for the connection to the boards.

A1 and A2 can be connected to one analog board each. Currently there are only analog input boards available. In other words one processor can be connected to max. two analog boards.

D1 and D2 can be connected to digital boards. There are input and output boards available. A digital board has a connector itself to be linked to another board. The daisy chained boards must be of the same type (input or output) and must not exceed the maximum number of 16. In theory you could combine 16 digital inputs (or outputs) to D1 and 16 additional inputs (or outputs) to D2. De facto, 32 boards exceed the space of one 19" housing.

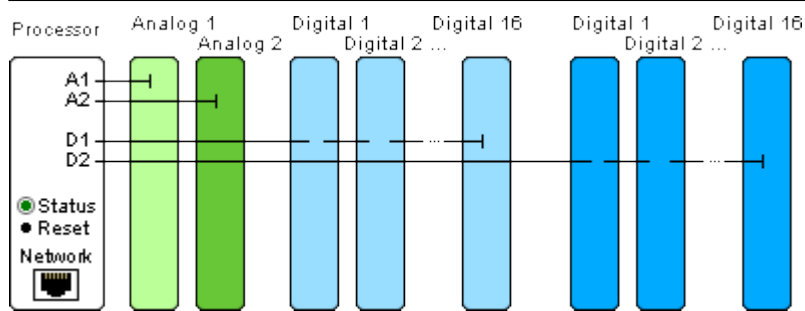

**Board modules**

Each board is depicted and described in detail in the next chapter. As well there are examples in which application they can be used.

**Analog boards - Input modules**

- Calibration Fiber Input
- 0 - 5V Input
- 0 - 10V Input
- 0 - 5V Sensor Input

**Digital boards - Input modules**

- 12V Relay Input
- 24V Relay Input

**Digital boards - Output modules**

- 48V AC / 30V DC Relay Output

Every board is 1-slot-wide. As explained above they are connected either to the processor unit itself or to a preceding board. In addition it has a power connection plug.

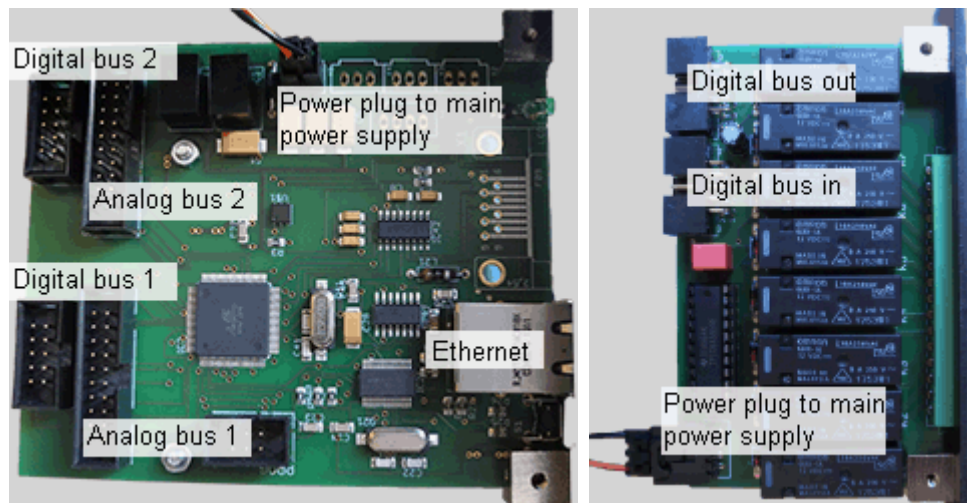

## 7.12.2 NET LINK BOARDS AND EXAMPLES

This chapter explains the available boards for the NET Link and shows examples how to use them. Please see the [introductory chapter](#)<sup>747</sup> for other information.

### Analog board - Input modules

Currently there are only analog input boards available, no output ones. Each board has 8 galvanically isolated connectors. They detect the incoming voltage in specific, gradual steps providing detailed data information from the connected sensor. Software-wise this is expressed through a value range from 0 to 1023. An application would be a light sensor controlling automatically the brightness of the projection. Principally it is like in the below depicted example with the buzzer, only that the buzzer's place is taken by the sensor and that the switch closes gradually instead of open / close.

Please find below a list with all available input modules:

### Calibration Fiber Input



8 fiber connectors for single-core (!) fiber cables with a diameter of 0.98mm<sup>2</sup> cables obtainable at your local distributor

DIP switch on the printed circuit board that sets the sensitivity: coarse / fine; fine is default and should be only changed when measured values exceed the value range; coarse mode has the same value range but roughly halves the measured value

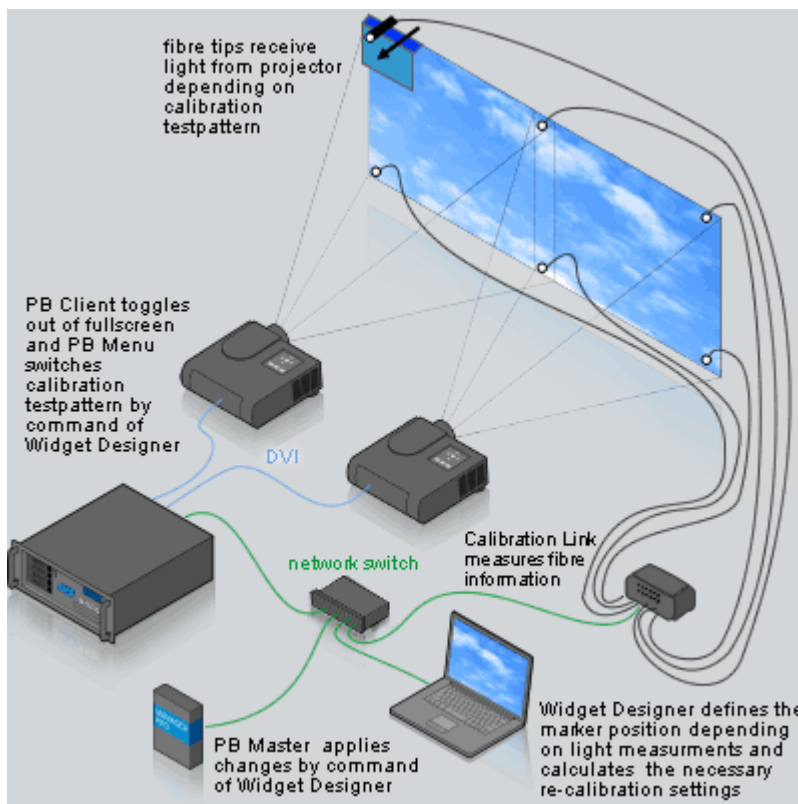

The depicted example is explained in detail in the chapter "[Projector Calibration Manager](#)"<sup>1236</sup>.

The depicted example is

**0 - 5V Input**

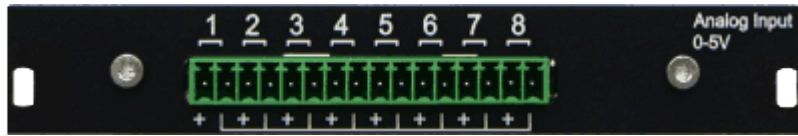

8 connectors, galvanically isolated  
 phoenix plug (for two laces per connector  $\leq 2.5\text{mm}^2$ )  
 maximum voltage of 5V  
 30k $\Omega$  input impedance  
 value resolution (in software):  $5\text{V} / 1024 = 4.88\text{mV}$  per step  
 external power source for sensors is needed  
 could be used for GPI In if 5V are used; an If-node could filter all values > 0 for "On"

- 0 - 10V Input

8 connectors, galvanically isolated  
 phoenix plug (for two laces per connector  $\leq 2.5\text{mm}^2$ )  
 maximum voltage of 10V  
 30k $\Omega$  input impedance  
 value resolution (in software):  $10\text{V} / 1024 = 9.77\text{mV}$   
 external power source for sensors is needed

- 0 - 5V Sensor Input

8 connectors, galvanically isolated  
 dedicated separate [Molex](#) plugs (for 3 laces per connector  $\leq 0.5\text{mm}^2$ ; Black: Ground 0V, Red: Power +5V, White: Signal 0-5V)  
 maximum voltage of 5V  
 30k $\Omega$  input impedance  
 value resolution (in software):  $5\text{V} / 1024 = 4.88\text{mV}$  per step  
 provides internal power source of 5V for each connected sensors

**Digital boards - Input modules**

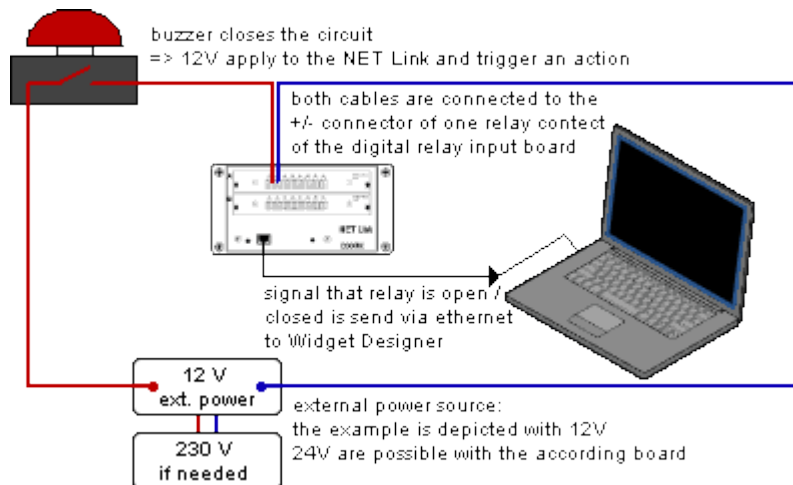

There are two digital input boards: one for 12V and one for 24V. Both have 8 galvanically isolated connectors. They detect the incoming voltage in two steps and provide the information, whether the connected sensor is in On- or Off-mode. Software-wise this is expressed through the two values 0 and 1. If the voltage exceeds 80%, the status switches to "On". If the voltage falls below 20%, it switches to "Off". An exemplary application would be a buzzer that triggers a cue. If you need to work with 230V, a power circuit breaker is needed for 12V / 230V.



- 12V Relay Input
  - 8 connectors, galvanically isolated
  - phoenix plug (for two laces per connector  $\leq 2.5\text{mm}^2$ )
  - maximum voltage of 12V
  - 30k $\Omega$  input impedance
  - "On" or "1":  $> 9,6\text{V}$
  - "Off" or "0":  $< 1,2\text{V}$
  - external power source for sensors is needed
  - operating lifetime: 100 000 switchings
  - could be used for GPI In if 12V are used; for the commonly used 5V, the analog input would apply
  
- 24V Relay Input
  - 8 connectors, galvanically isolated
  - phoenix plug (for two laces per connector  $\leq 2.5\text{mm}^2$ )
  - maximum voltage of 24V
  - 30k $\Omega$  input impedance
  - "On" or "1":  $> 19,2\text{V}$
  - "Off" or "0":  $< 2,4\text{V}$
  - external power source for sensors is needed
  - operating lifetime: 100 000 switchings

**Digital boards - Output modules**

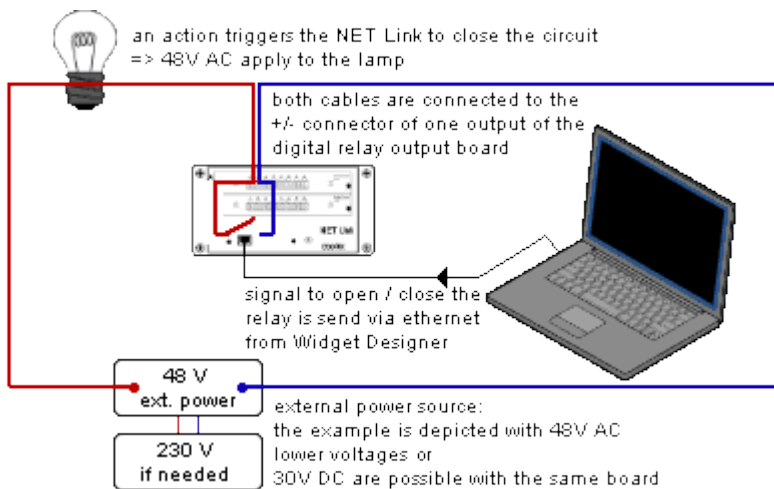

Currently there is one digital output boards. It has 8 galvanically isolated connectors / contact closures. They close the circuit at the software's command. All boards connected to the same digital bus are synchronized . If the maximum number of 16 daisy-chained output relays are connected to D1 (or D2), 16 x 8 = 128 contacts can be closed in sync. D1 and D2 can have a delay of maximum one frame.



- 48V AC / 30V DC Relay Output
  - 8 connectors, galvanically isolated, polarity can be reversed
  - phoenix plug (for two laces per connector  $\leq 2.5\text{mm}^2$ )
  - maximum voltage of 48V AC or 30V DC and maximum ampere of 4A



30kΩ input impedance  
 contacts are normally open (NO)  
 external power source is needed  
 could be used for GPI Out if external voltage is used as commonly done in broadcast environment; for other application, an external power source must be considered somehow

### 7.12.3 NET LINK SOFTWARE

This chapter explains the software settings for controlling the NET Link and getting information from it. Please see the [introductory chapter](#)<sup>747</sup> for other information.

Software-wise the NET Link is included in the Widget Designer. The communication between WD and the device is based on an ethernet connection, not USB.

Create > Nodes > Input > Devices > ... or Create > Nodes > Output > Devices > ...  
[Relay Output node](#)<sup>1126</sup>: receiving information from other nodes and controlling the connected NET Link, if it is mounted with (digital) relay output boards  
[Calibration Link Input node](#)<sup>989</sup>: receiving information from the connected Calibration Link or NET Link with analog input board for fibers; values are transferred to other nodes or software (e.g. the Warper); the Calibration Input works with the tool "[Projector Calibration Manager](#)<sup>1236</sup>"  
[NET Link Input node](#)<sup>1040</sup>: receiving information from the connected NET Link (or Calibration Link) according to the input boards and transferring this information to other nodes or software

All nodes are controllable with [node commands](#)<sup>977</sup>. Using them, the input node turns into an output node as well. For instance, this command closes a relay. `SetRelayDigitalBus1, ID, State`

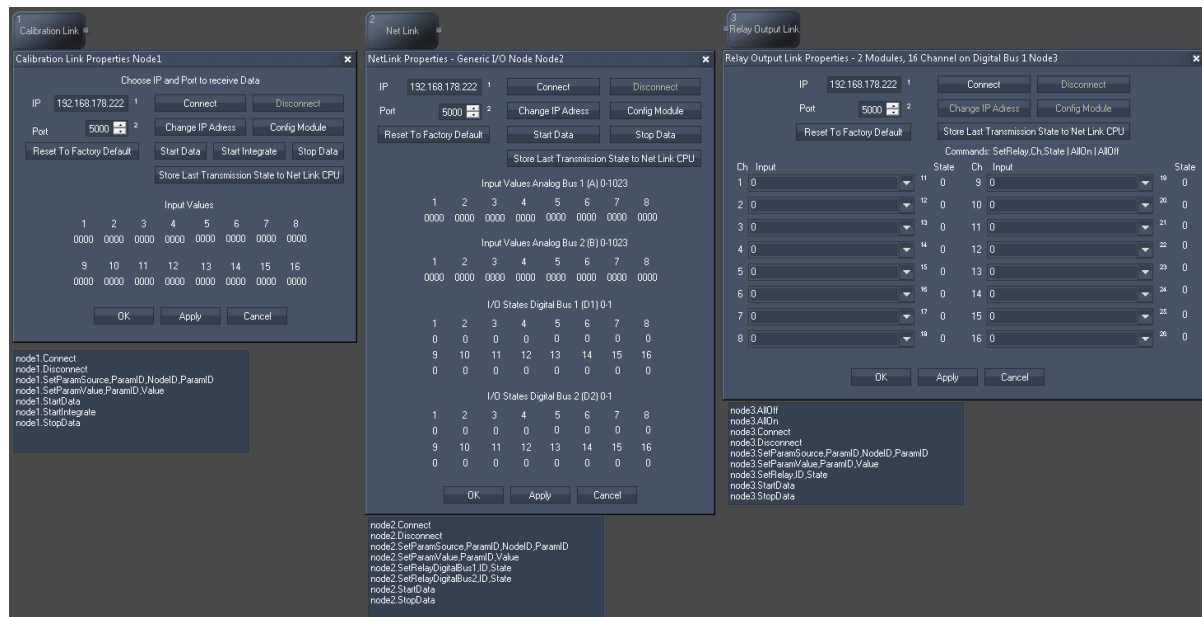

## 8 PB MENU



The onscreen menu enables you to control and access most common tasks and applications from the onscreen button menu.



## MASTER & CLIENT

Depending on the mode set up in the mode menu of the LCD display, you may start Pandoras Box either in MASTER or CLIENT mode.

## WARP

Press WARP to launch Pandoras Box Warper.

## BROWSER

Press BROWSER to open the Windows Explorer.

## OUTPUT

Press OUTPUT to open the Nvidia Control Panel for advanced graphics card and output configurations.

## NETWORK

Press NETWORK to open the network dialog to set individual IP addresses for each "Lan" adapter. Please note: the status menu of the LCD display shows only the IP address for the "Lan" adapter.

## SERVICE

Press SERVICE to launch the service menu, including the commands TASKMANAGER, RAID UTILITY, MODE and RESET MENU.



Inside the service menu you have the following options:

### TASK MANAGER

The task manager provides detailed information about computer performance and running applications, processes and CPU usage, commit charge and memory information, network activity and statistics, logged-in users and system services

### RAID UTILITY

This tool allows collecting information about the server's raid system and gives the possibility to manage it.

Please note: Do not touch the raid system settings unless you are well skilled in doing this. If there are hard drive / raid problems, please contact [support@coolux.de](mailto:support@coolux.de) or your local distributor for support!

### MODE

Press MODE and the version dialog opens.

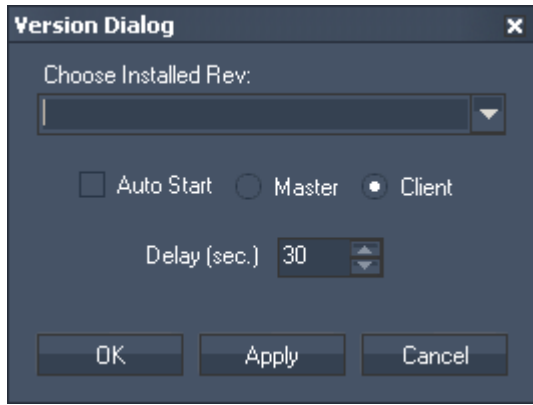

Choose one of your installed PB versions within the drop down list. The MASTER and CLIENT buttons then will refer to this choice.

Checking the Auto Start option with Master or Client will automatically launch the selected PB revision after the Onscreen Menu started. Set up the desired delay by entering the amount of time in seconds.

#### RESET MENU

Press RESET MENU to reboot the LCD Display and the onscreen menu. This is important to refresh the current state to the menu when settings were changed directly under Windows.

#### [VNC REMOTE](#)<sup>860</sup>

Press VNC REMOTE to launch the VNC Remote application. It enables you to scan the network for PB devices running the onscreen menu Rev. 32 or higher and to remote-control them.

#### HELP

Press HELP to launch the Pandoras Box Helpfile.

#### TASKBAR ON

Press TASKBAR ON / OFF to show or hide the Windows taskbar.

#### SHUT DOWN

Press SHUT DOWN to power off the server.

Below the buttons the system's IP addresses and the onscreen Rev. are displayed.

## 9 MATRIX PATCHER

For special applications where LED or lighting fixtures are required to be patched to individual pixels, you will need to use the Matrix Patcher to set up your patch. With the saved patch file in your Pandoras Box project, the output will be additionally rendered to multiple Art-Net universes.

Since revision 6700 the Matrix Patcher plays also an important role if working with LED video tiles that are connected via DVI and a LED video processor. Most LED video processors are capable of creating only horizontal and vertical layouts for the video tile alignment. As soon as any of the tiles are rotated (in any angle), content mapping can be very difficult and complex to setup. For those creative applications Matrix Patcher and a new Pixel Re-Mapping FX were designed.

Please see the topics below for working with the Pandoras Box Matrix Patcher:

[Matrix Patcher User Interface](#) <sup>757</sup>

[Fixture Editor](#) <sup>764</sup>

[Patching Guide](#) <sup>770</sup>

[ReMapping Guide](#) <sup>776</sup>

### 9.1 MATRIX PATCHER USER INTERFACE

The Matrix Patcher User Interface is divided into several sections:

[File Menu](#) <sup>758</sup>, [Edit Menu](#) <sup>759</sup>, [Toolbar](#) <sup>759</sup>, [Fixture Library](#) <sup>760</sup>, [Fixture Navigation Tools](#) <sup>761</sup>, [Fixture Patch](#) <sup>761</sup> and [Patch Settings](#) <sup>763</sup>.

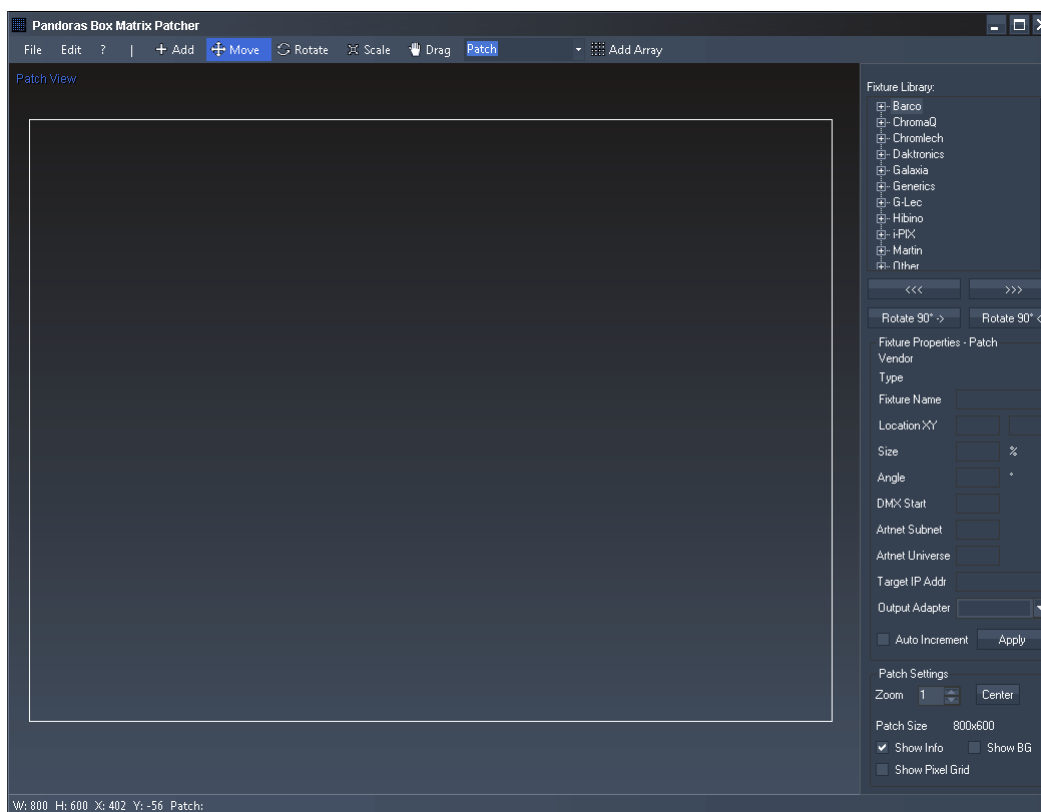

### 9.1.1 FILE MENU

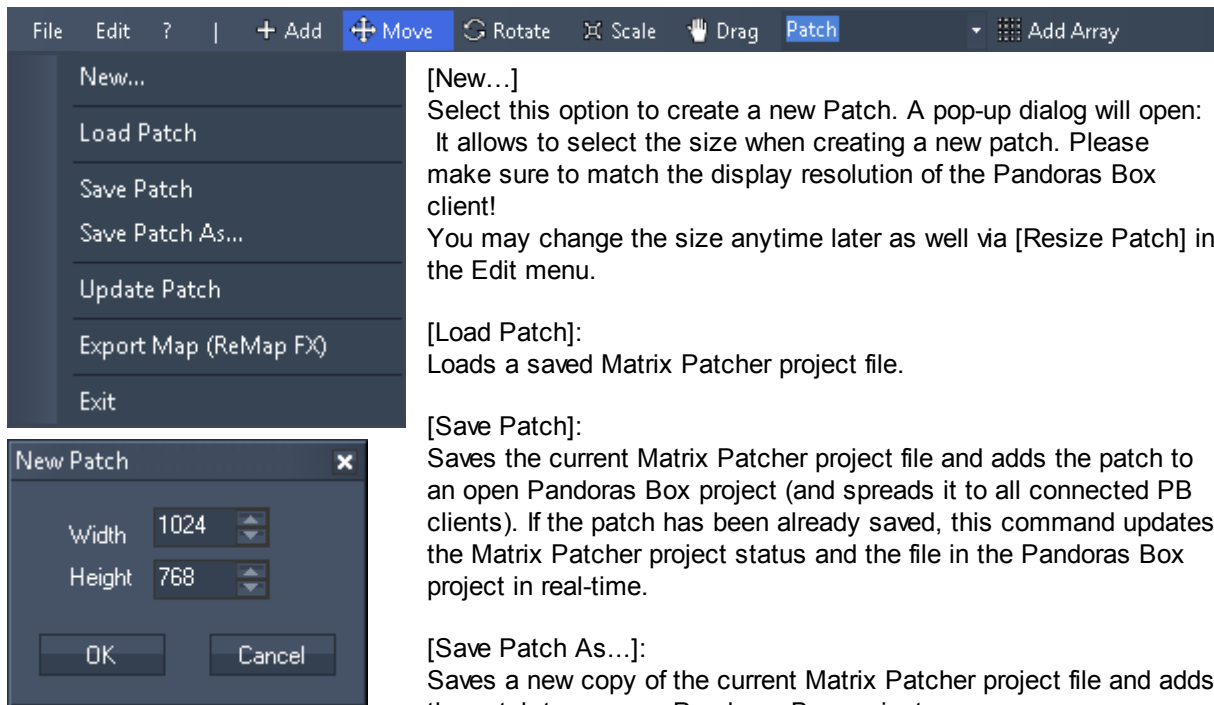

**[New...]**  
 Select this option to create a new Patch. A pop-up dialog will open: It allows to select the size when creating a new patch. Please make sure to match the display resolution of the Pandoras Box client!  
 You may change the size anytime later as well via [Resize Patch] in the Edit menu.

**[Load Patch]:**  
 Loads a saved Matrix Patcher project file.

**[Save Patch]:**  
 Saves the current Matrix Patcher project file and adds the patch to an open Pandoras Box project (and spreads it to all connected PB clients). If the patch has been already saved, this command updates the Matrix Patcher project status and the file in the Pandoras Box project in real-time.

**[Save Patch As...]:**  
 Saves a new copy of the current Matrix Patcher project file and adds the patch to an open Pandoras Box project.

**[Update Patch]:**  
 Saves the current Matrix Patcher project file and adds the patch to an open Pandoras Box project (and spreads it to all connected PB clients). If the patch has been already saved, this command updates the Matrix Patcher project status and the file in the Pandoras Box project in real-time.

Please note: Since revision 49 the \*.csv format is an obsolete format. From now on, Pandoras Box version 5.3 can read the Matrix Patcher file directly. However, if you still have copies of those \*.csv files and want to work with them, simply drag them into the project manually. From here, Pandoras Box treats a csv like a pbx file.

**[Export Map (ReMap FX):**  
 Exports a png file for use in Pandoras Box as a media for the ReMap FX.

**[Exit]:**  
 Quits Pandoras Box Matrix Patcher.

## 9.1.2 EDIT MENU

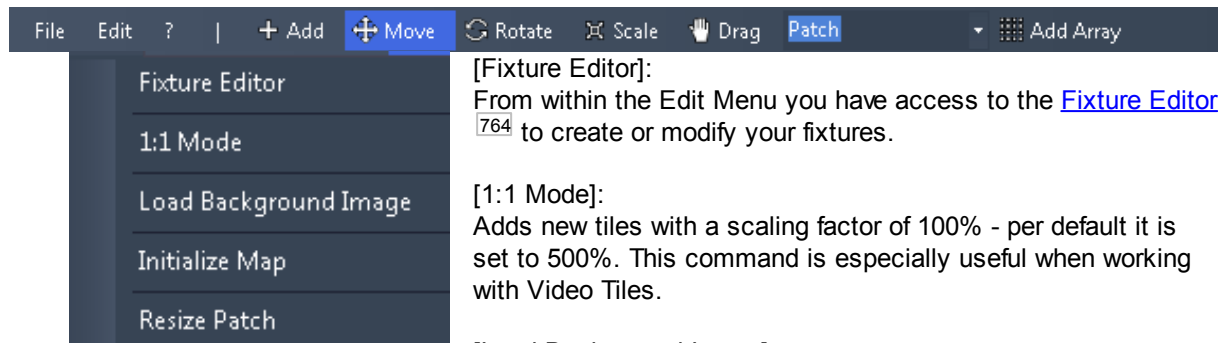

### [Fixture Editor]:

From within the Edit Menu you have access to the [Fixture Editor](#) <sup>764</sup> to create or modify your fixtures.

### [1:1 Mode]:

Adds new tiles with a scaling factor of 100% - per default it is set to 500%. This command is especially useful when working with Video Tiles.

### [Load Background Image]:

This option opens a Windows explorer dialog where you may select an image to be loaded as background image in order to simplify creating the patch. To display the image the option [Show BG] in the [Patch Settings](#) <sup>763</sup> has to be enabled!

### [Initialize Map]:

Redraws the [Map view](#) <sup>759</sup>. It discards all changes made there and applies all position / rotation / scale information from the [Patch view](#) <sup>759</sup>. For more information please have a look at the [ReMapping Guide](#) <sup>776</sup>.

### [Resize Patch]:

Choose the new patch size (Width and Height, in px) in the pop-up dialog. Please make sure to match the display resolution of the Pandoras Box client exactly!

## 9.1.3 TOOLBAR

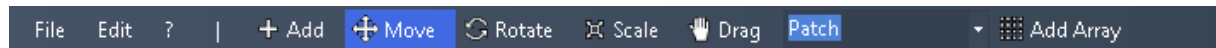

### [Add]:

To add a new fixture to the patch, select a fixture from the Fixture Library first! Every click inside the patch now will create one fixture of the selected fixture type.

### [Move]:

The Move Mode allows to move the fixtures on the patch. Just click on it and move it to the desired position. For accurate positioning you may want to enter the fixtures location in the [Fixture Patch](#) <sup>761</sup>.

### [Rotate]:

The Rotation Mode allows to rotate a fixture on the patch. Select the fixture by clicking on it. Hold the left mouse button pressed while moving the mouse cursor up (=clockwise rotation) or down (=anti-clockwise rotation). To rotate the fixture in an accurate angle you may want to enter the angle value in the [Fixture Patch](#) <sup>761</sup>.

To rotate the fixture in 90° steps, you may as well simply use the Buttons [Rotate 90° ->] and [Rotate 90° <-] that you will find under [Fixture Navigation Tools](#) <sup>761</sup>.

### [Scale]:

The Scaling Mode allows to scale a fixture on the patch. Select the fixture by clicking on it. Hold the left mouse button pressed while moving the mouse cursor left (=decreasing the fixture size) or right (=increasing the fixture size). To scale the fixture to an accurate size you may want to enter the scaling factor value in the [Fixture Patch](#) <sup>761</sup>.

[Drag]:

When being in Drag Mode you may move the whole Patch around in order to reach every part of the patch.

[Patch / Map Mode]:

This mode is interesting when working with rotated LED video tile connected via DVI and a LED video processor.

For more information please have a look at the [ReMapping Guide](#)<sup>776</sup>.

[Add Array]:

After selecting a fixture from the Fixture Library this command will help you to add not only ONE copy to your current patch file (as the "Add" command does), but several ones. A dialog opens where you can set up how many copies you would like to add and the way how the array is inserted.

The Art-Net settings are of course only available if a DMX fixture was chosen from the library. The options are described [here](#)<sup>761</sup>.

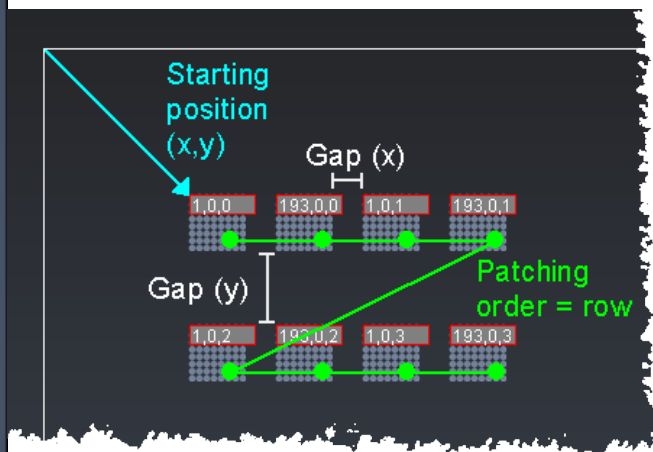
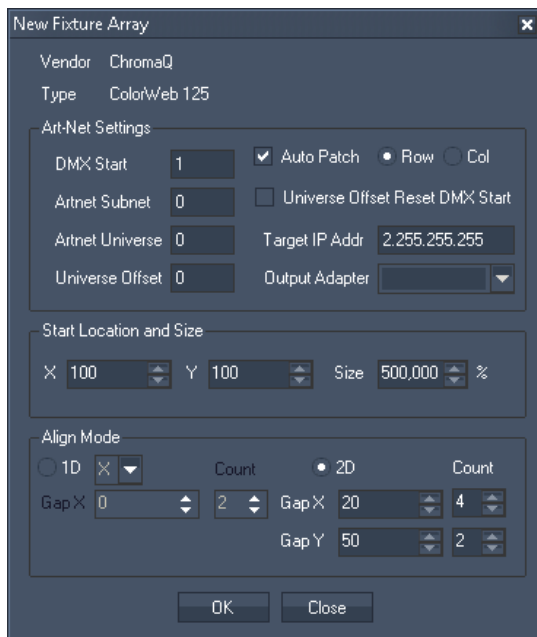

### 9.1.4 FIXTURE LIBRARY



The Fixture Library contains a stock of common LED-Fixtures, sorted by vendor name. Every Fixture you created with the Fixture Editor will appear here as well.

To add one of the fixtures to the patch, select the fixture and choose [Add] from the toolbar. Then click inside the patch field.

If you need to add more copies, the ["Add Array"](#)<sup>759</sup> function is a great time saver.



### 9.1.5 FIXTURE NAVIGATION TOOLS

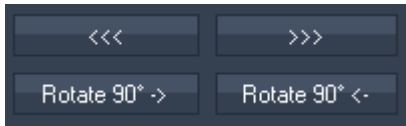

[<<<] / [>>>]:

These buttons allow you to easily step through the fixtures added in the patch. The selected fixture will turn green and will be loaded into the [Fixture Patch](#)<sup>761</sup> section.

[Rotate 90° ->] / [Rotate 90° <-]:

To rotate the selected fixture in 90° steps, you may simply use the Buttons [Rotate 90° ->] and [Rotate 90° <-].

### 9.1.6 FIXTURE PATCH

The Fixture Properties Patch displays information about the type of the selected fixture and allows as well to set up a unique name, its location, size, angle and the DMX addressing including network settings.

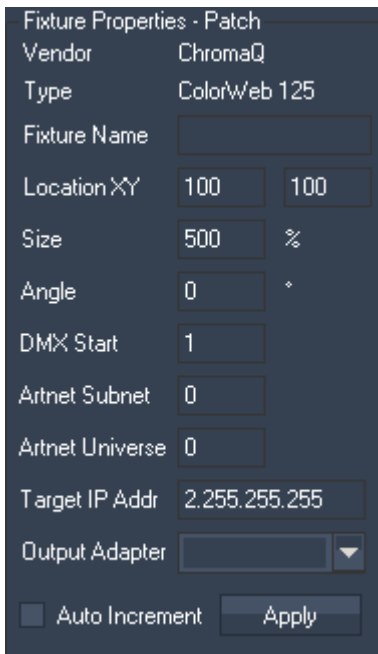

[Vendor] and [Type]:

See here the Vendor and Type of the currently selected fixture.

[Fixture Name]:

Here you may add a unique name to the currently selected fixture. Press [Apply] to assign the modification to the fixture.

[Location X/Y]:

See here the selected fixture's location for X and Y (in px, according to your patch size).

The location may be changed by entering new values for X and Y, or by using the Move Mode (see [Toolbar](#)<sup>759</sup>).

Press [Apply] to assign the modification to the fixture.

[Size]:

See here the selected fixture's size (in %). This size may be changed by entering a new value or by using the Scaling Mode (see [Toolbar](#)<sup>759</sup>). Any new fixture added on the patch will be scaled to 500% by default.

Press [Apply] to assign the modification to the fixture.

[Angle]:

See here the selected fixture's angle (in °). To change its angle enter a new value in the text field, use the Rotation Mode (see [Toolbar](#)<sup>759</sup>) or the 90°-Rotation Buttons (see [Fixture Navigation Tools](#)<sup>761</sup>).

Press [Apply] to assign the modification to the fixture.

[DMX Addressing]:

Using the DMX Addressing (including DMX Start address, Art-Net Subnet and Art-Net Universe) you may set up the fixtures in two different ways:

1. on the one hand it allows to modify the addressing of the selected fixture (press [Apply] to assign the modification to the selected fixture).
2. On the other hand you may enter the start address for the fixtures that are going to be added to the patch. Don't press [Apply] in order to use this function! Otherwise the modified DMX addressing is going to be assigned to the currently selected fixture.

++ Background information regarding DMX Addressing and network performance ++

One Art-Net-Universe contains 512 DMX channels (from 1-512). One Art-Net-Subnet contains 16 Art-Net-Universes (from 0-15). There can be 16 Art-Net Subnets (from 0-15). So in theory you may be able to address  $512 \times 16 \times 16 = 131.072$  DMX channels within one patch. As one pixel is represented by its color information, e.g. RGB, it takes up three channels, resulting in 43.690 pixels.

But when putting this into practice, we have to take the transfer rates of the transmitting network components and receiving devices into account too. This is the true limitation regarding the question how many pixel data in form of Art-Net universes can be transferred. As a rule of thumb, we do not recommend to output more than 60 universes per network.

Let's have a closer look: One Art-Net universe takes up 572bytes. As soon as you send only one channel, the entire universe needs to be transmitted. The default transfer frequency is 44Hz (40Hz, 33Hz and 25Hz are common too, especially for older devices). Thus each components needs to transfer 0,1-0,2 Mbit/s. This applies to switches as well as to the receiving devices. Most of the time these ones have lower specifications, e.g 10Mbit/s, which limitates us to approx. 60 universes. With 60 universes you can transfer approx.  $100 \times 100$ px.

Per default, Art-Net is set up as a broadcast protocol which means that all data is send to each client within the network. Considering the above mentioned, this means that  $100 \times 100$ px is the limitation for the entire network, not only per device.

Since revision 49 the Matrix Patcher gives you the possibility to apply multi- or even unicast methods. The advantage is, that you may decide where the information is actually send to. Thus you may use your network resources more efficiently.

To do so, set up the "Target IP Address" per fixture.

- 2.255.255.255 - example for fixture 1 - the default address is a broadcast address.
- 2. 0 .255.255 - example for fixture 2 - the multicast method saves network resources.
- 2. 0 . 0 . 255 - example for fixture 3 - the multicast method saves network resources.
- 2. 0 . 0 . 5 - example for fixture 4 - the unicast method uses the network resources to its full capacity.

If we had the following devices connected via a switch to the Pandoras Box client:

- 2. 0 . 0 . 5 - Device A receives the information from fixtures 1, 2, 3, 4
- 2. 0 . 0 . 22 - Device B receives the information from fixtures 1, 2, 3
- 2. 0 . 11. 5 - Device C receives the information from fixtures 1, 2
- 2. 3 . 11. 5 - Device D receives the information from fixture 1

As you can see, the broadcast information is sent to all devices. Even though it transfers information only for ONE panel, the other panels have to read and discard this information. This lowers the remaining amount of data that can be sent to this panel per second. If programming the patch to sent the information only via unicast, the receiving devices in the network do not need to discard unnecessary information and can be used more efficiently.

A downside of this method is, that you loose flexibility. In case the entire network routing has to be changed or only a single device needs to be set to a different IP address, keep in mind that the software patch needs to be updated as well. In conclusion, the multicast method combines efficiency and flexibility.

[Network adapter]:

Choose the name of the network adapter that should output the Art-Net information. If an explicitly named network adapter is not found, the "any" adapter will be used. This is to be decided by the operating system and depends on your network adapter settings.

In case of processing a lot of Art-Net data it is very much recommended to use one network adapter for

the communication with the Pandoras Box Master software and one separate network adapter for the Art-Net communication. All Pandoras Box Servers are shipped with a dual network card providing this working method.

[Auto Increment]:

Use this function to automatically increment the DMX addressing when adding several fixtures to the patch. If checked, the application will calculate the next free DMX and Art-Net Address and patch added fixtures to it.

Example:

You want to add fixtures with a total channel count of 120 channels. You set the addressing to (1,0,0): DMX Start address = 1, Art-Net Subnet = 0 and Art-Net Universe = 0. Auto Increment is checked.

- The 1st fixture gets the Start address ( 1 , 0 , 0 ),
- the 2nd fixture gets the Start address (121, 0 , 0 ),
- the 3rd fixture gets the Start address (241, 0 , 0 ),
- the 4th fixture gets the Start address (361, 0 , 0 )
- the 5th fixture gets the Start address ( 1 , 0 , 1 ).

The 5th fixture with its 120 channels won't completely fit any more into the Universe 0, so it gets assigned to the next higher Universe.

### 9.1.7 PATCH SETTINGS

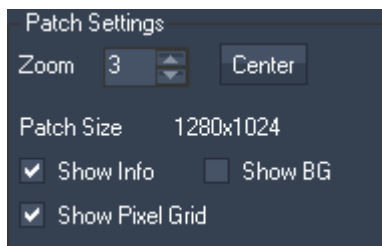

The Patch settings allow you to change the Patch View.

[Zoom]:

You may set a higher zoom factor to zoom into the patch (by default the zoom factor is set to 1).

[Center]:

Press [Center] to move the patch's center point into the center of the user interface. This can be helpful after dragging the patch.

[Patch Width & Height]:

The patches size is displayed here.

[Show Info]:

When enabling this option, the DMX Addressing will be shown on the patch for each fixture. In the left image you see two fixtures. Their DMX address is shown in the respective upper left corner. The lower fixture is highlighted blue as it is currently selected.

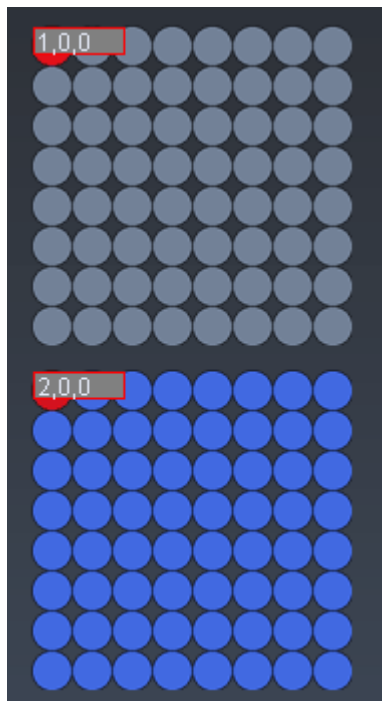

[Show BG]:

A background image (for example a floor plan) may be displayed on the patch, this can be helpful for some patches. To do so, load a background image (see [Edit Menu](#)<sup>759</sup>) and enable the option [Show BG].

[Show Pixel Grid]:

Uncheck this option if you don't want to see the pixel grid in the patch.

Please note that with some patch sizes and zoom factors the pixel grid can't be displayed.

## 9.2 FIXTURE EDITOR

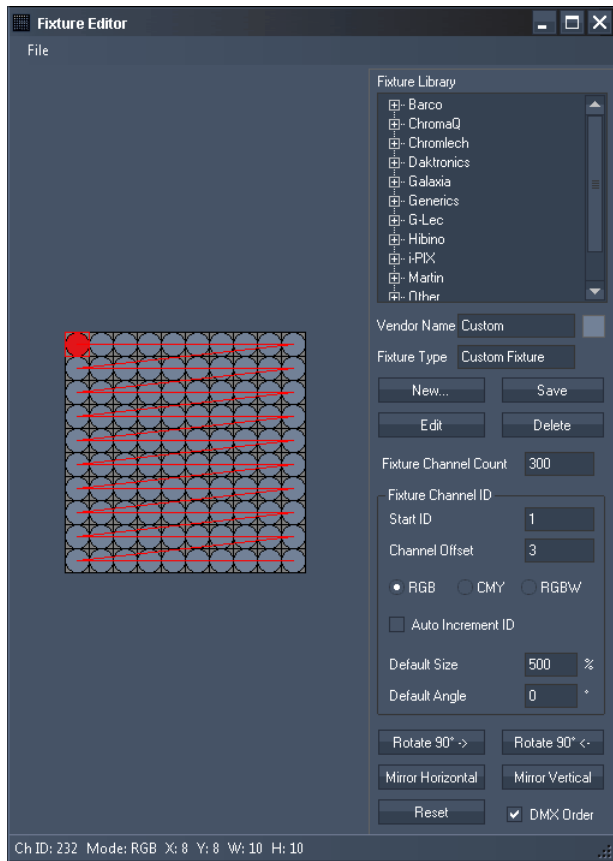

The Fixture Editor allows to create and modify fixtures that can be used in the patch. Open the fixture editor via the [Edit Menu](#)<sup>759</sup> from the Main Matrix Patcher User Interface.

The Fixture Editor is divided into the following sections:

[File Menu](#)<sup>764</sup>,  
[Fixture Library](#)<sup>765</sup>,  
[Fixture Channel ID](#)<sup>766</sup> and  
[Fixture Workspace](#)<sup>767</sup>.

See here a guide of [how to create and edit fixtures](#)<sup>768</sup>.

### 9.2.1 FILE MENU

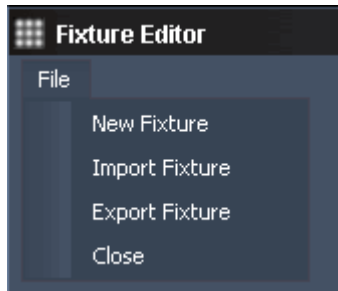

**[New Fixture]**

Creates a new fixture. Please note that any prior work won't be saved.

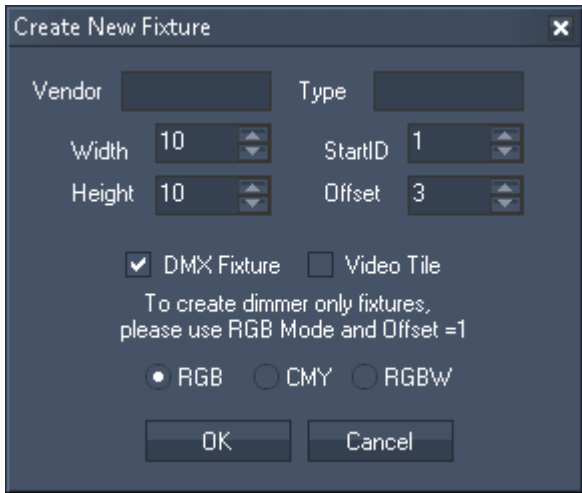

In the pop-up dialog you may enter the Vendor Name, the fixture type, its Width and Height (in px), the Start ID and the Offset. An offset of 3 (by default) will create 3 DMX channels (RGB or CMY) per pixel.

If you wish to create a fixture that should be controlled via DMX or Art-Net, tick the check box "DMX Fixture".

To create dimmer only fixtures, please use RGB Mode and Offset=1.

You may choose as well the colour mode: RGB or CMY, according to your fixture.

If you wish to create a fixture that should be controlled via DVI, tick the check box "Video Tile".

[Import Fixture]:

Imports existing fixtures (.mfx) into the library.

[Export Fixture]:

Exports fixtures from the library to be saved for later use (as .mxf-files).

### 9.2.2 FIXTURE LIBRARY

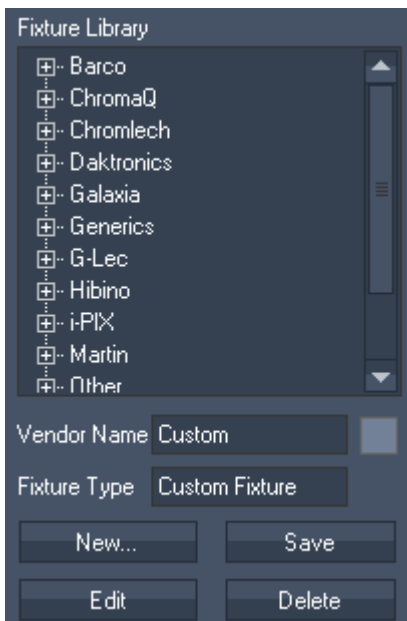

The Fixture Library contains a stock of common LED-Fixtures, sorted by vendor name. Every Fixture that was created with the Fixture Editor will appear here as well.

This section allows to create a new custom fixture and edit or delete any existing fixture.

[Vendor Name / Fixture Type]:

As soon as a fixture is created or set to be edited, the Fixture's Vendor Name and Type will be displayed in the text fields.

[Fixture Colour]:

The small colored box next to the Vendor Name (in the picture above shown in orange) allows to choose the fixture's background colour. It will open a colour-picker once you click on it

[New...]:

Allows to create a new fixture, see [File Menu](#)<sup>764</sup>. Please note that any prior work won't be saved automatically. The Fixture will be loaded into the Workspace now for further editing.

[Edit]:

To start editing an existing fixture, please select the fixture in the Fixture Library and press [Edit]. The Fixture will be loaded into the Workspace now for further editing.

[Save]:

Saves the changes in the fixture under the Vendor Name and Fixture Type currently displayed.

[Delete]:

Deletes the fixture currently selected in the fixture library.

### 9.2.3 FIXTURE CHANNEL ID

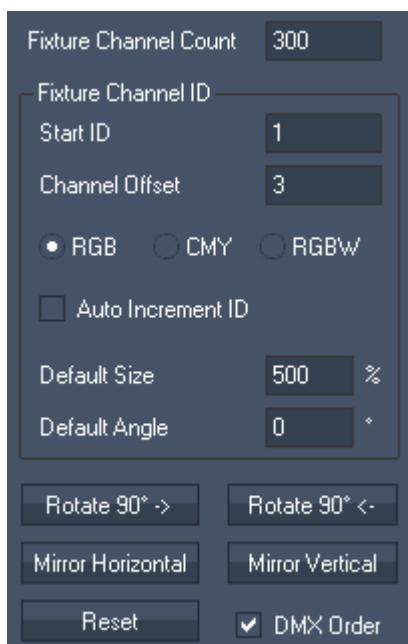

Within the Fixture Channel ID section the DMX Addressing for the selected fixture will be set up.

[Fixture Channel Count]:

This is the amount of channels the fixture contains. It is calculated by the Fixtures Width and Height multiplied with the Channel Offset. For example, the fixture is 4 px wide and 4 px high and has an offset of 3 channels (for RGB), then the Fixture Channel Count is  $4 \times 4 \times 3 = 48$  channels. This Channel Count is used to calculate the start address for the next fixture when setting up the patch.

In order to create fixtures with unpatched pixels you need to manually modify that number, so that the start address for the next added fixture is correct when using auto increase while patching the matrix.

[Start ID]:

This is the DMX Start Address for the next pixel.

[Channel Offset]:

Amount of DMX channels per pixel

[RGB / CMY]:

Defines if the colour values of the pixels will be interpreted as RGB or as CMY.

[Auto Increment ID]:

When activated the starting channel of the pixels will automatically be incremented according to the chosen offset.

Default [Size]:

This is the fixture's size when added on the patch. By default it is set to 500%, you may change this size when editing a fixture.

**[Default Angle]:**

The default angle refers to the fixture's angle when it will be added on the patch.

**[Rotate 90° ->] / [Rotate 90° <-]:**

To rotate the selected fixture in 90° steps, you may simply use the Buttons [Rotate 90° ->] and [Rotate 90° <-].

**[Mirror Horizontal / Mirror Vertical]:**

This allows to mirror the selected fixtures horizontally or vertically.

**[Reset]:**

Clears the DMX addressing of the currently selected fixture.

**[DMX Order]:**

When this option is checked, it shows the pixel addressing order in the fixture with a red line. The starting pixel is marked with a red dot.

## 9.2.4 FIXTURE WORKSPACE

When creating a new fixture or editing an existing one, the fixture will be loaded into the workspace.

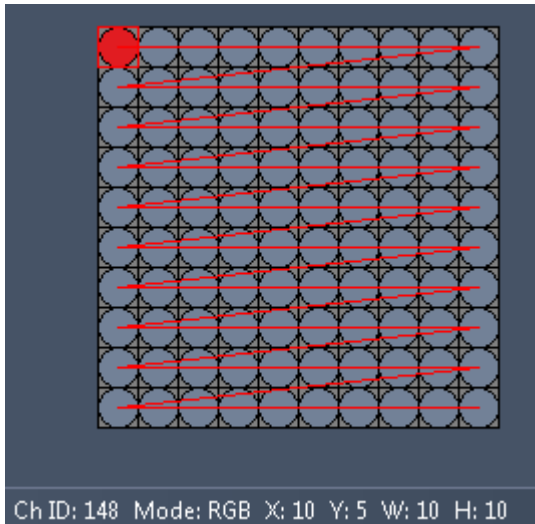

In the workspace you see every pixel the fixture contains.

In case of a DMX fixture, the pixels are displayed as dots. The applied DMX order is shown as red line, the DMX starting pixel is marked as red dot.

When moving the mouse cursor over the fixture, the line at the bottom displays the information about each pixel: the Channel ID, the colour mode (RGB or CMY), the pixel's position as well as the Fixture's Width and Height.

The fixture's DMX Order may be modified when the fixture is created or when being in Edit-Mode, please see [How To Create And Edit Fixtures](#)<sup>768</sup>.

In case of a video tile, the pixels are displayed as squares. Of course no DMX order needs to be displayed. No adjustments have to be made.

### 9.2.5 HOW TO CREATE AND EDIT FIXTURES

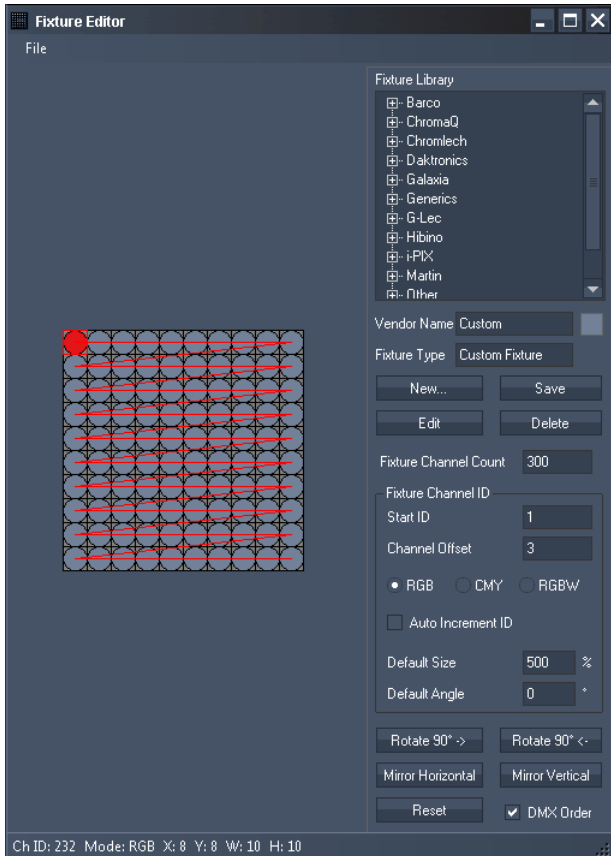

This chapters explains in more detail how to set up DMX fixtures. If you are working with Video Tiles feel free to proceed with the [next](#)<sup>770</sup> chapter or the [ReMapping Guide](#)<sup>776</sup>.

A new fixture with the Width=10, Height=10 and the offset=3 was created by pressing [New...]. The default DMX channel order goes from the fixture's top left pixel (the first channel is marked as red dot) over to the right and then starts at the left in the next line and so on. You see this channel order displayed by the small red line.

By mouse-over on any of these point you find the pixel information according to this point at the bottom left: the channel ID, the colour mode, X and Y position and the total width and height of your fixture.

To arrange a new DMX order for your fixture, press [Reset] at the bottom right to clear the channel settings, see next picture.

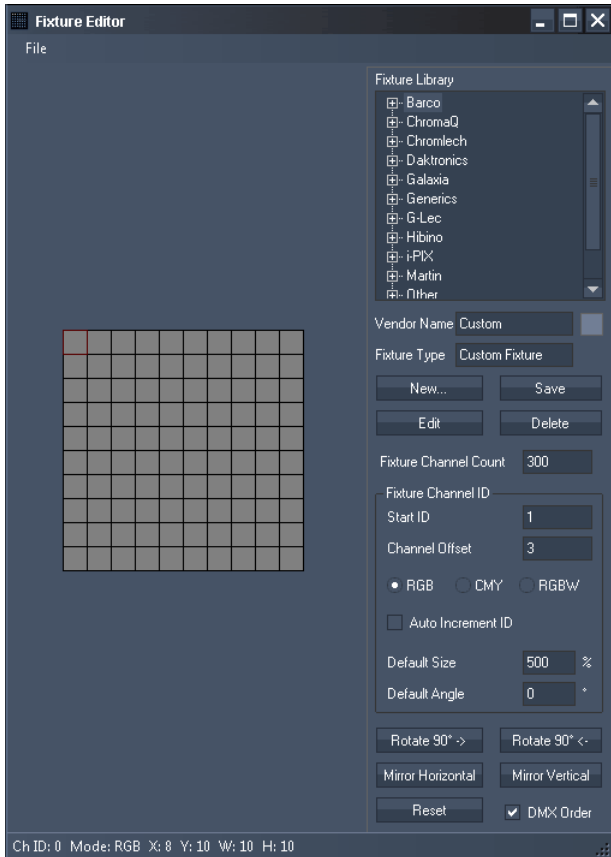

Now there is no channel order for the fixture. You have two possibilities to apply a custom DMX channel order to the fixture:

- DMX Addressing using the Auto Increment ID Option or
- Manually DMX Addressing.

DMX Addressing using the Auto Increment ID option:

To automatically increment all Channel IDs based on the Start ID, check "Auto Increment ID". The text fields for Start ID and Channel Offset will be greyed out then.

Please be sure that you begin with the right Start ID: While creating a new DMX order and resetting it, the Start ID counts up and does not reset automatically.

Now start drawing the channel order on the fixture with the mouse cursor:

Click on the start pixel (it will be shown in full red) and go on in the correct order. Do it click by click or hold down the left mouse button.

If you did a wrong click, re-click on this pixel to remove the addressing again.

It could look like the next picture now:



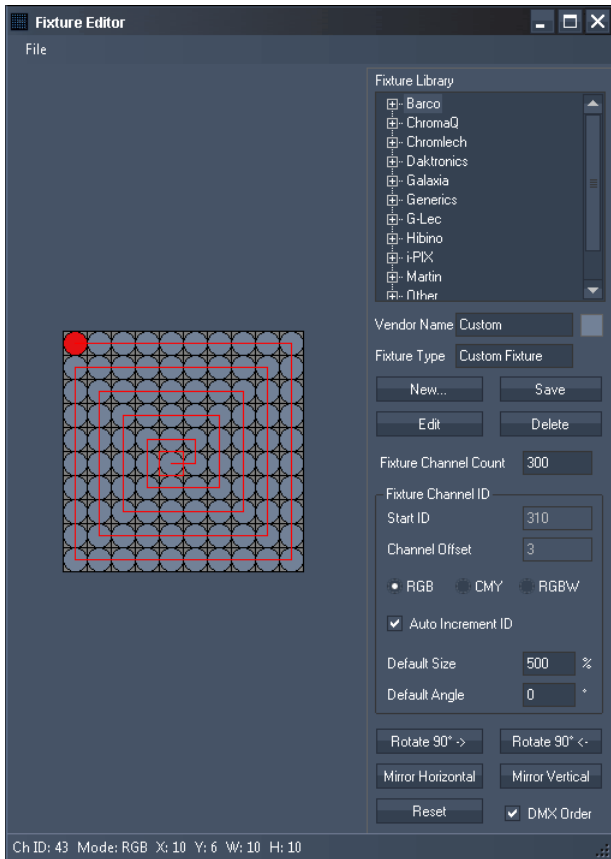

In the Fixture Channel ID section you see that the Start ID was counted up, so that the next pixel you click on would get the start address 301. If you're not confident with the current addressing, the button [Reset] may be pressed again to clear the pixel addressing.

Please note: before re-drawing the pixel addressing check the Start ID to be set back to 1! To do this disable the Auto Increment ID option, enter the Start ID 1 and enable the Auto Increment ID option again.

Having finished your new DMX order, if needed, you can rotate the matrix 90° to the left or right or mirror it horizontally or vertically by clicking the corresponding buttons down left.

Very important: Press [Save] to assign all changes!

Manually DMX Addressing

This way could make sense if you have a fixture that has unpatched pixels. Let's start again with the plain fixture.

When not using the Auto Increment ID function, enter every pixels Start ID BEFORE you click on it on the fixture!

Example:

The 10x10 px fixture should be addressed so that after every second pixel there a 3 unpatched channels: Pixel (1,1) starts with channel 1, Pixel (1,2) starts with channel 4, Pixel (1,3) starts with channel 10, Pixel (1,4) starts with channel 13, pixel (1,5) starts with channel 19 and so on.

To achieve this DMX order, do this:

- Enter Start ID=1, then click on Pixel (1,1).
- Enter Start ID=4, then click on Pixel (1,2).
- Enter Start ID=10, then click on Pixel (1,3).
- Enter Start ID=13, then click on Pixel (1,4),

...

Having finished your new DMX order, if needed, you can rotate the matrix 90° to the left or right or mirror it horizontally or vertically by clicking the corresponding buttons down left.

Very important: Press [Save] to assign all changes!

Editing existing Fixtures

If you want to edit an existing fixture, choose it from the fixture-list scroll down menu and press [Edit]. Now you can modify it by acting as if you create a new one. Keeping the old name will result in overwriting the fixture when saving it. You may type in a different name as well, then it will be saved under this one as a new fixture.

### 9.3 PATCHING GUIDE

The Pandoras Box Matrix Patcher starts with the main patching window:

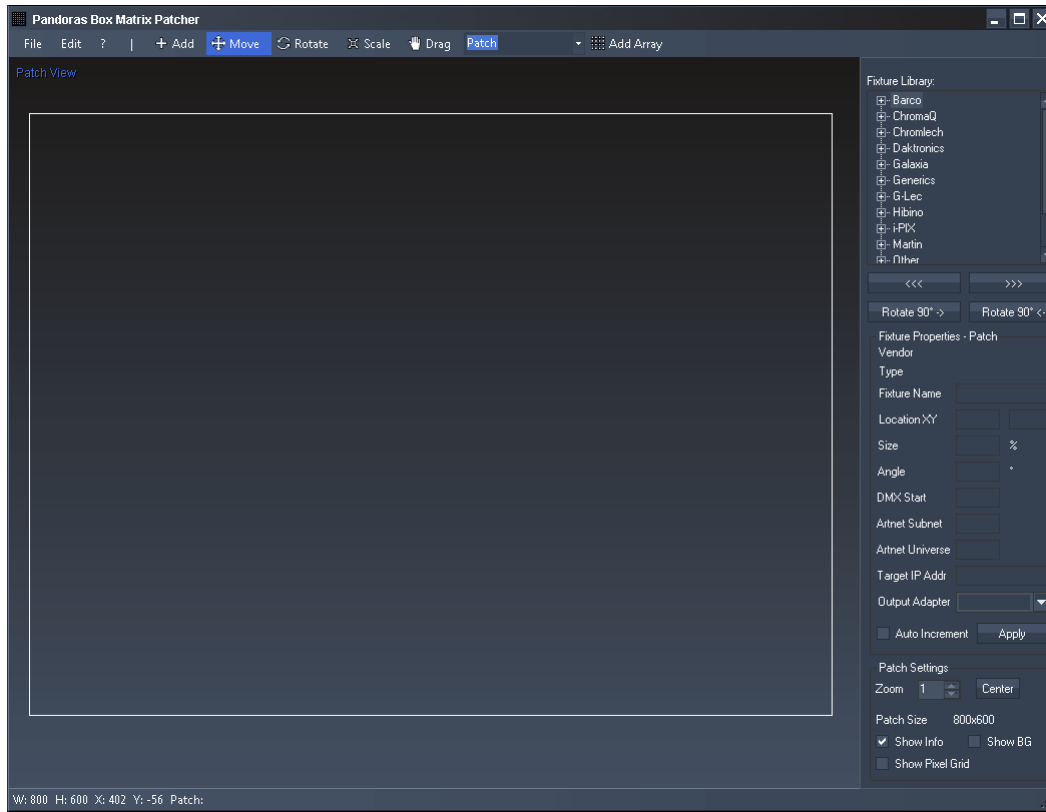

The Fixture Library on the top right contains a stock of fixtures by different vendors. If the fixtures you need are not included or if the fixtures need to be modified, you have to create/edit them first using the [Fixture Editor](#)<sup>764</sup>. See here a guide of [how to create and edit fixtures](#)<sup>768</sup>.

As soon as all fixtures needed are available in the Fixture Library you may start setting up your patch.

#### Important information about setting up the patch size

The Matrix Patcher up from Revision 12 should be used with big patch sizes, although you maybe only need a patch that is 10x10 pixels big! The reason for this is that the patch size always refers to the size of the Pandoras Box output that is used for the Matrix.

Example 1:

The Pandoras Box output 1 of a PB server should be used to control your LED Panels. The display attached to this output is set up to the resolution 1024x768 px. The LED Panels where the video content should be displayed on are 20 px wide and 20 px high.

- a) If the patch is only 20x20 px large (according to the amount of pixels of the LED Panels), only a fraction of the whole PB layer size will be used for the Matrix, illustrated by the red square in the picture below. This way the content (in this example the coolux logo) has to be scaled very small to be completely displayed on your devices. And this is quite unhandy.

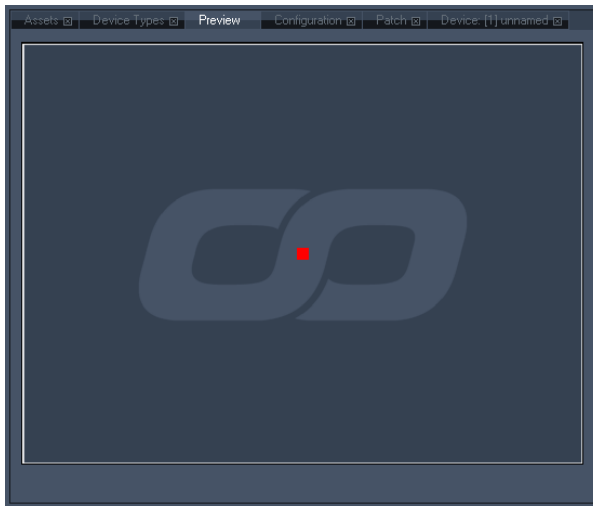

Left side:

By default the video content (the coolux logo) covers the whole output (output size: 1024x768 px). A patch with the size 20x20 px would only give out DMX data for the area that is covered by the red square.

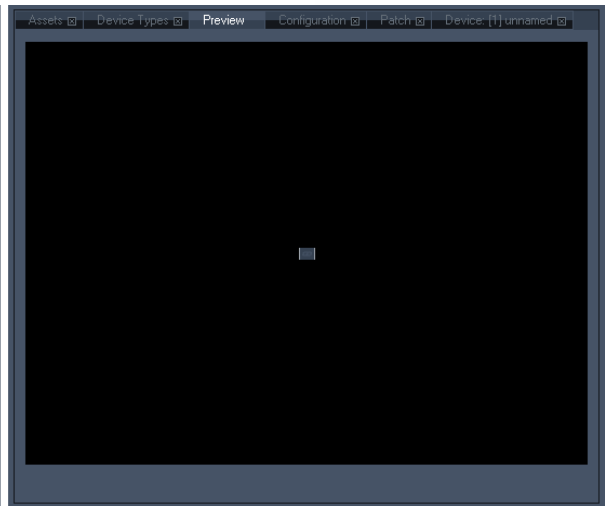

Right side:

To ensure that the logo will be shown on your LED Panels with its whole height, it has to be scaled down a lot.

- b) A better and more handy workflow inside Pandoras Box is given when the patch gets close to the size of the Pandoras Box Matrix output (PB output= 1024x768 px). You may create a patch now that is 1024x768 px. The fixtures on the patch will be scaled up and arranged so that they form a square (because of the pixel aspect ratio 20:20) covering the whole patch's height. The colour values for one pixel of the patch will now be calculated as average value from a bigger area, not only from one pixel as shown in the example 1a. See picture below.

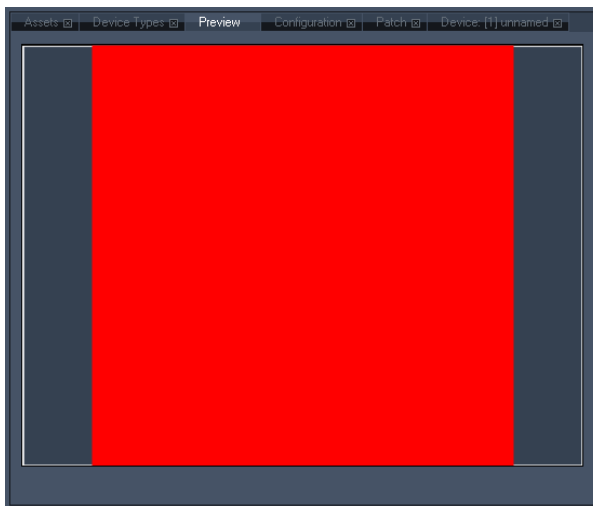

Left side:

By default the video content (the coolux logo) covers the whole output (output size: 1024x768 px). The fixtures on the patch with the size 1024x768 px cover nearly the whole output, shown by the red square.

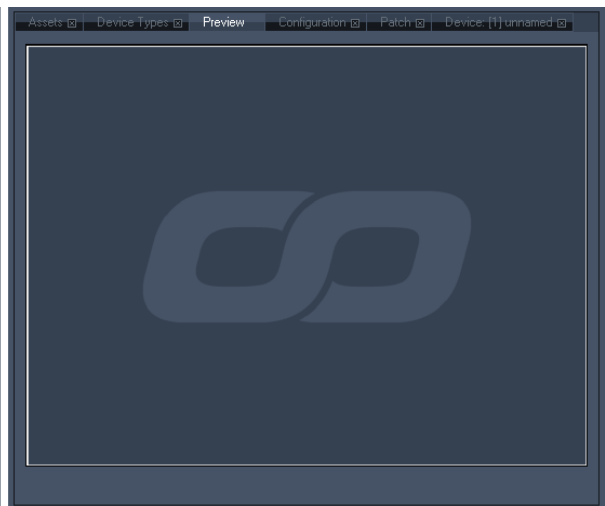

Right side:

To ensure that the logo will be shown on your LED Panels with its whole height, it has not to be scaled down any more!

### Patch Size

In the [Patch Settings](#)<sup>763</sup> the current patch size is displayed. By default the size is set to 1024x768 px. Adjust this patch size to fit your PB Matrix output resolution.

### Adding Fixtures

Now that the patch is set up, you need to add one or several fixtures to your patch. Let's assume that you want to place 3 square fixtures (with the size 10x10 px) side by side in a line, covering the whole width of the patch.

Select the fixture in the Fixture Library. If it is not available set it up in the [Fixture Editor](#)<sup>764</sup> first. But before adding the fixtures on the patch, think about how they should be addressed if working with DMX fixtures. Turn over to the [Fixture Patch](#)<sup>761</sup> and enter the DMX starting address and the Art-Net Subnet and Universe for the first fixture. Don't press [Apply] as this should be used only when modifying DMX addresses after the fixture is created.

If the DMX addressing should be automatically incremented for all following fixtures, enable [Auto Increment]. If you want to address the following fixtures manually, you may enter the new DMX addressing in the Fixture Patch before adding the fixture to the patch.

Now click on [Add] in the [Toolbar](#)<sup>759</sup> or choose the add-function via the right-click menu and proceed a left mouse click in the patch area. Your first fixture will appear. Do this two more times to get all 3 fixtures on the patch.

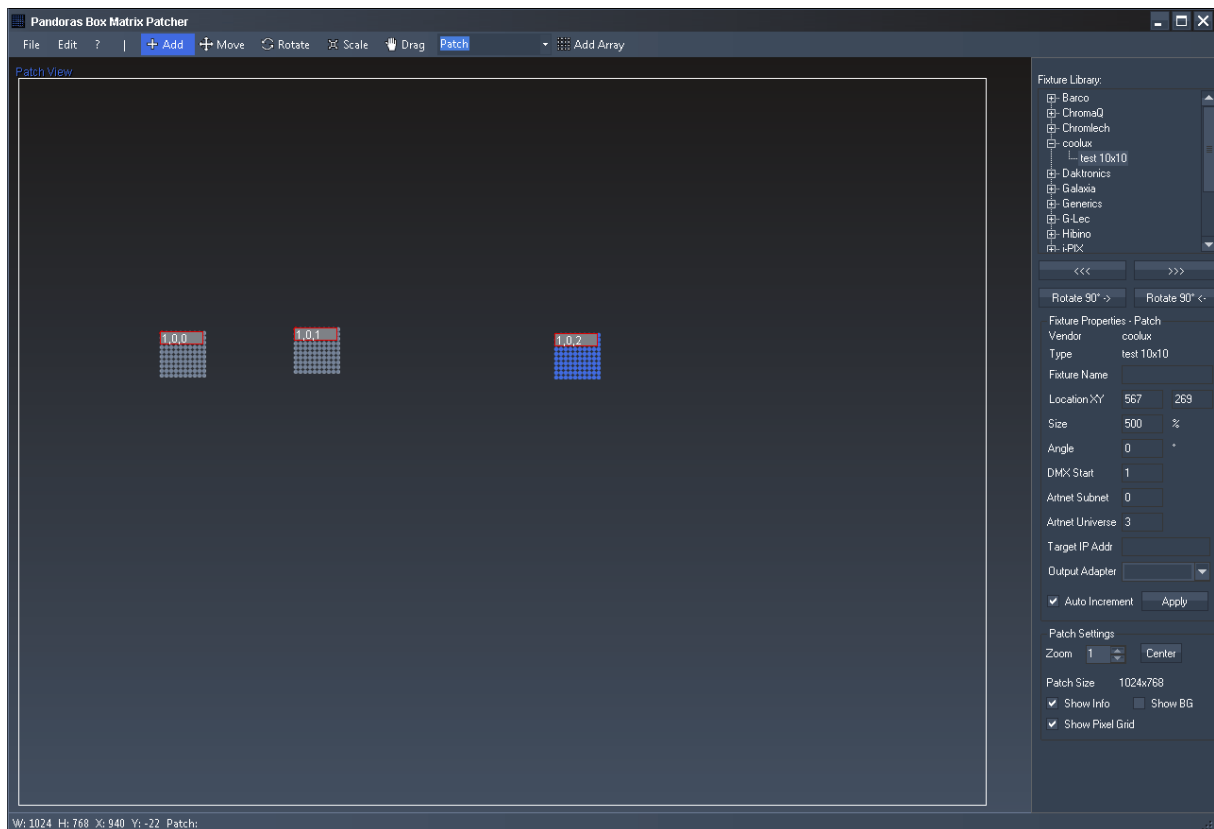

### Adjusting the fixtures on the patch

As the fixtures should cover the whole width of the patch, you have to position and scale them to the correct size. So that the result looks similar to this:

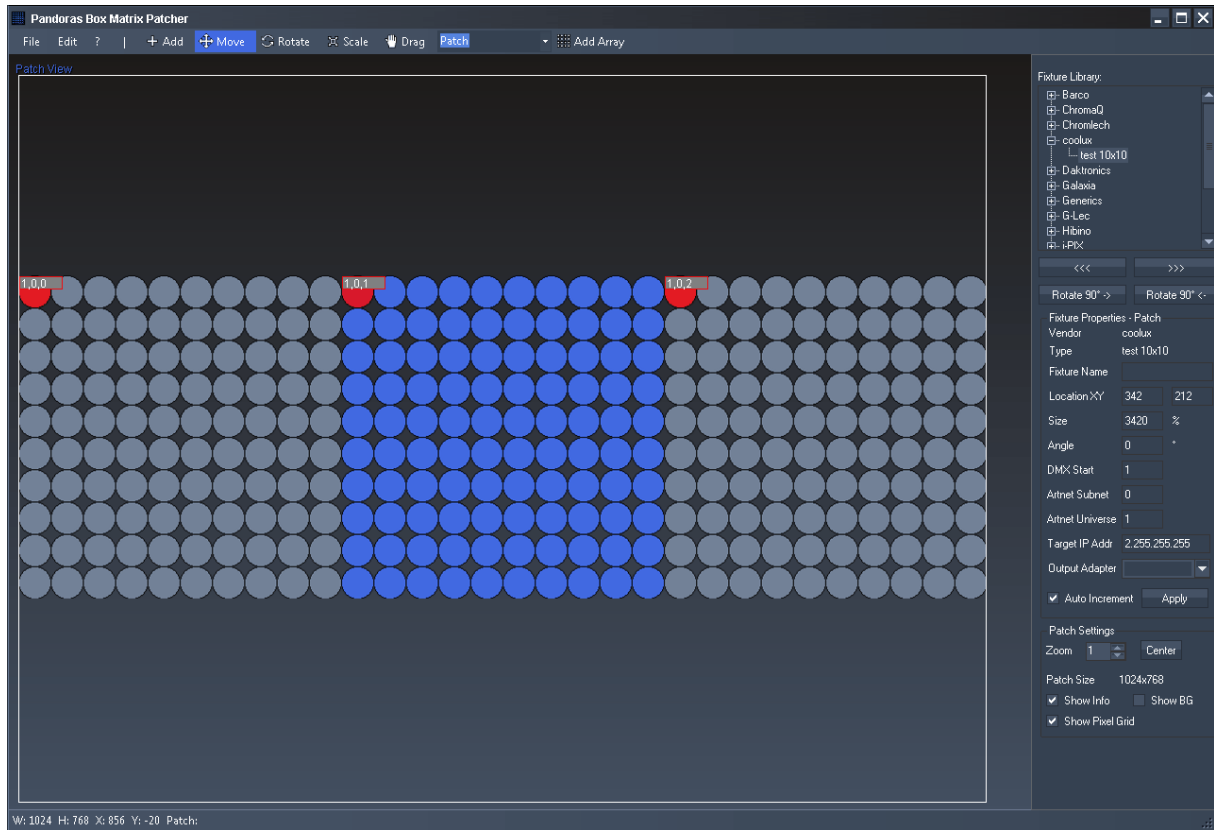

The scaling can be done in several ways: by eye, by calculating the correct zoom factor or by using a prepared background image.

- By eye:  
Turn to scale-mode using the right-click menu or pressing the scale button in the [toolbar](#)<sup>759</sup>. Click on the fixture and move the mouse cursor to the right while holding down the left mouse button. Do this for every fixture. Then adjust the positions by turning into the move-mode.

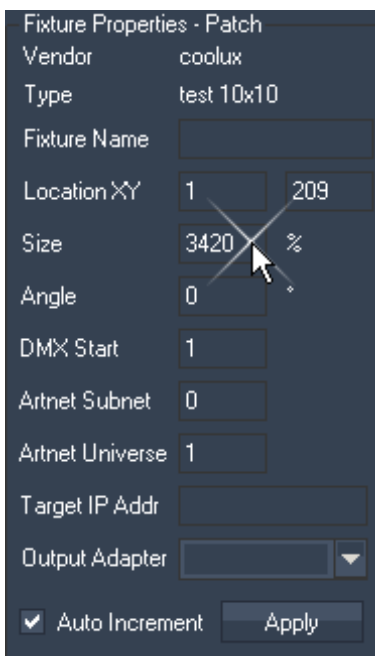
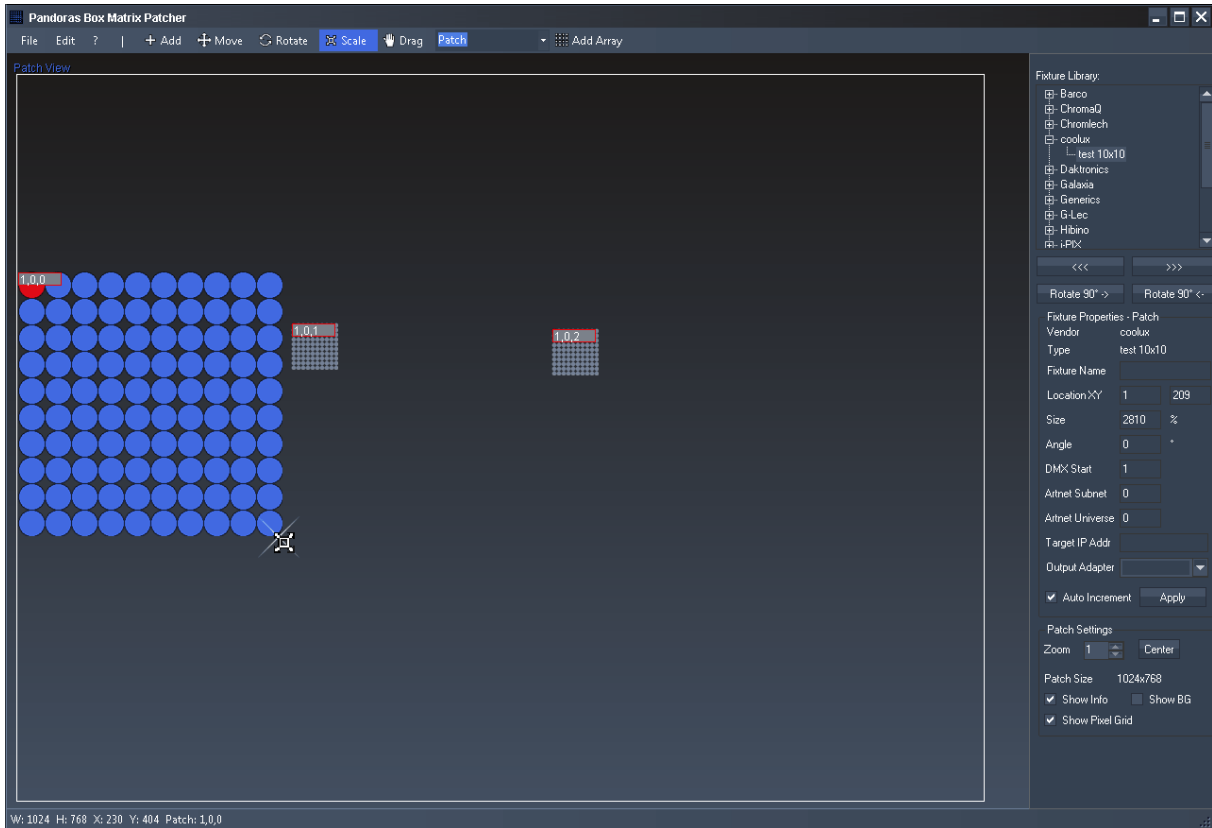

- By calculating the correct size (in %):  
The patch is 1024 px wide, one fixture is 10 px wide (zoom factor = 100%). A fixture should cover 1/3 of the patches width. So 1/3 of the patch width are  $1024/3 = 341,3$  px. To get the new size, divide the size 100% through the fixture's width (10 px) and multiply this with the width the fixture should cover (341,3 px):  
 $100\% / 10\text{px} \times 341,3\text{px} = 3413 \%$ .  
Select the first fixture when being in move-mode. Now enter the new size into the according text field in the [Fixture Patch](#)<sup>761</sup> and press [Apply]. Do this for all fixtures and position them on the patch.  
**Please note:** the size can only be applied in 10%-steps, so that you have to round the value up or down. In this case you could use a size of 3410% or 3420%.  
A faster workflow using this method is: when starting from the beginning, choose the fixture from the library and press the button "Add array", set up 3420% and choose to insert a "1D" array.

- By using a prepared background image:

You may prepare an image, that shows the correct adjustment of three items over the width of the image. This can be loaded as background image. To do so, go to Edit> Load Background Image and browse to the image path. To show / hide this image, toggle the option [Show BG] in the [Patch Settings](#) <sup>763</sup> down right.

This background image helps you now to scale and arrange the items on the patch.

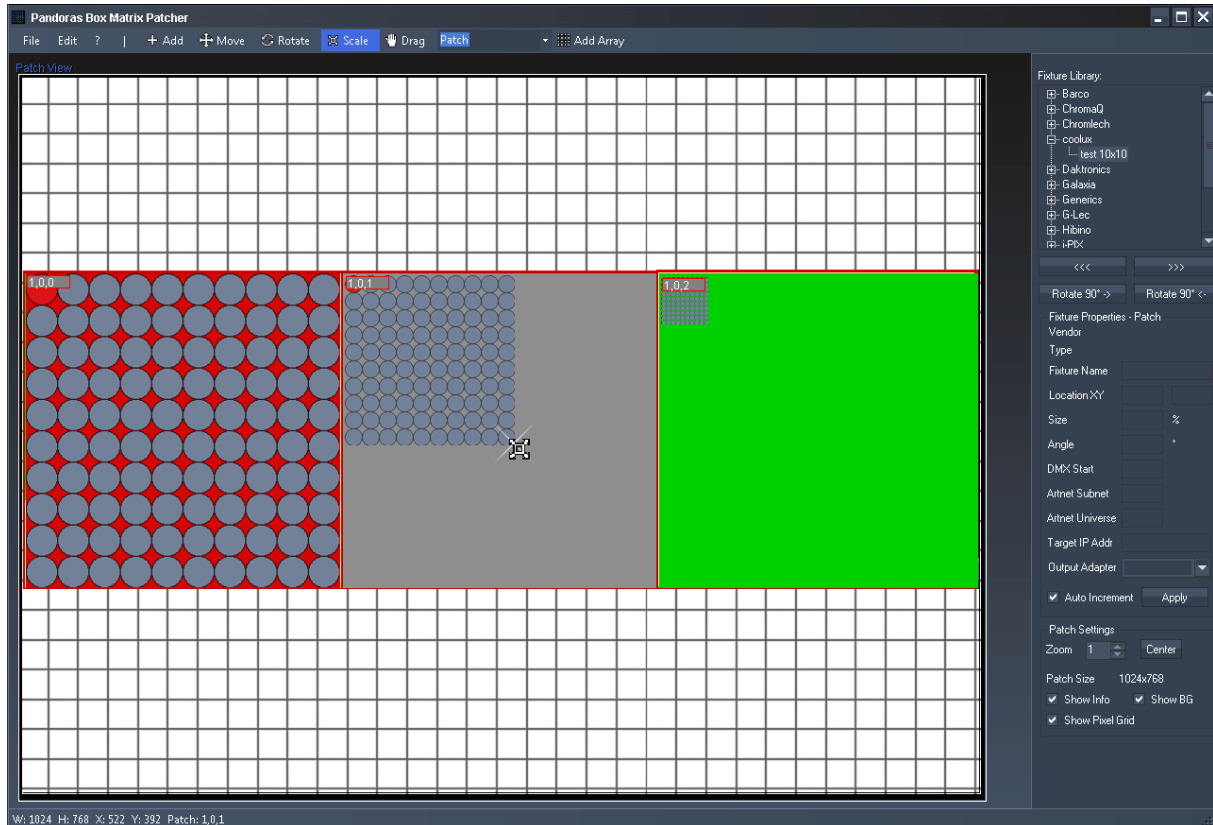

### Useful Hints:

You may check and modify the settings in the Fixture Patch for each fixture if necessary (e. g. the DMX addressing or the positioning).

To remove a fixture from the patch, highlight the fixture by clicking it and press [Del] on your keyboard.

### Save Patch & Export Matrix:

When patching the matrix is completed, it is recommended to save this patch file in order to still be able to modify it later on. Do this by File > Save Patch. In addition this command adds an according \*.pbx file as a media file to the project if a Pandoras Box Master software is running at the same time plus it spreads the file to all connected clients. This is very important, especially when working with DMX Fixtures as the Art-Net data is generated by the client and output through its network adapter.

Please note: In older versions (before Rev 49 and Pandoras Box 5.3) it was necessary to export a patch separately. Automatically a "pixelpatch.csv" was saved in the directory where the Matrix Patcher.exe file is located (e.g. C:\coolux\program files\Pandoras Box SERVER STD Rev xxx). This is now not necessary anymore. However, if you still have copies of those \*.csv files and want to work with them, simply drag them into the project manually. From here, Pandoras Box treats a csv like a pbx file.

The next step is, to use the generated matrix file in Pandoras Box. As soon as the file is included in the project you may start programming it onto the timeline. To do so, choose which Pandoras Box client should calculate the Art-Net data (in addition to the normal video output via DVI) and drag the matrix file on its [output](#)<sup>597</sup>. Please note, that effects dragged onto the output layer cannot be considered by the patch file, thus you will not see output effects on your DMX panels.

Of course each client in your PB network may be programmed with different matrix files. In addition it can be saved on the timeline and may change throughout the show.

Use the right-click menu in the [preview](#)<sup>234</sup> to visualize the matrix files.

If working with Video Tiles please proceed to the [ReMapping Guide](#)<sup>776</sup>.

## 9.4 REMAPPING GUIDE

This chapters explains in more detail how to use the remapping feature if working with Video Tiles that are connected via DVI and a LED video processor. If you are working with DMX Fixtures connected via Art-Net feel free to skip this chapter.

### BACKGROUND INFORMATION

Most LED video processors are capable of creating only horizontal and vertical layouts for the Video Tile alignment. As soon as any of the tiles are rotated (in any angle), content mapping can be very difficult and complex to setup.

For those creative applications Matrix Patcher and a new [Pixel Re-Mapping FX](#)<sup>525</sup> were designed.

### DIFFERENCE BETWEEN PATCH AND MAP VIEW

The patch view represents the output pixels, that is how the tiles are programmed and located in the LED processor.

The map view is for relocating the individual tiles in any orientation and size according to the real setup. In other words the map view represents the source pixels of a Pandoras Box Layer Composition Space. In Pandoras Box you set up the content (and layers) according to the stage in the real world. There is no need to create special content in a complex way anymore.

The combination of both views results in the exported map png. The map stores for each source pixel the position of the output pixel. Afterwards the ReMap FX in Pandoras Box reads the map and routes automatically any source pixel to the stored output location. Thus it routes the pixels according to the patch / map setup that you may influence at any time of programming.

When creating Video Tiles you would first create a Video Tile layout as in the video processor view and then switch to the Map View and adjust the tiles as seen in the real world.



STEP BY STEP: How to use the ReMapping feature

- Create a new Patch with the same (!) resolution Pandoras Box Output is set to and how the LED video processor is controlled
- If the fixtures needed are not included in the Fixture Library, create new Video Tiles in the [Fixture Editor](#) <sup>764</sup>
- Add these Video Tiles in the Patch View as they would be laid out in the LED processor
- Then choose "Initialize Map" from the Menu and switch to the Map View that now looks like the Patch View to start with

In the image below a background image was chosen. It shows a scene from the real stage setup. This is helpful for the next step.

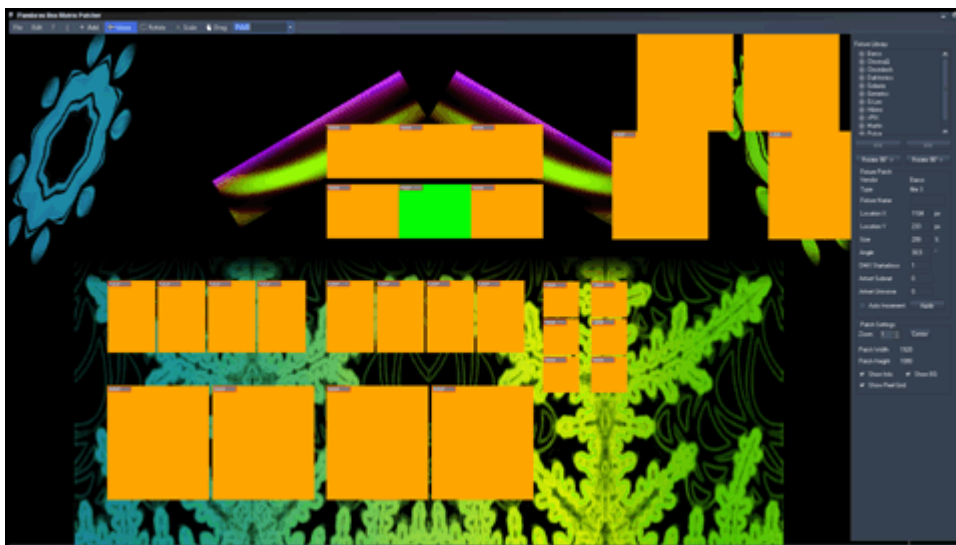

- Now re-arrange and rotate the Video Tiles in the Map View as they are in the real world. You can do this by eye or by using a prepared background image.

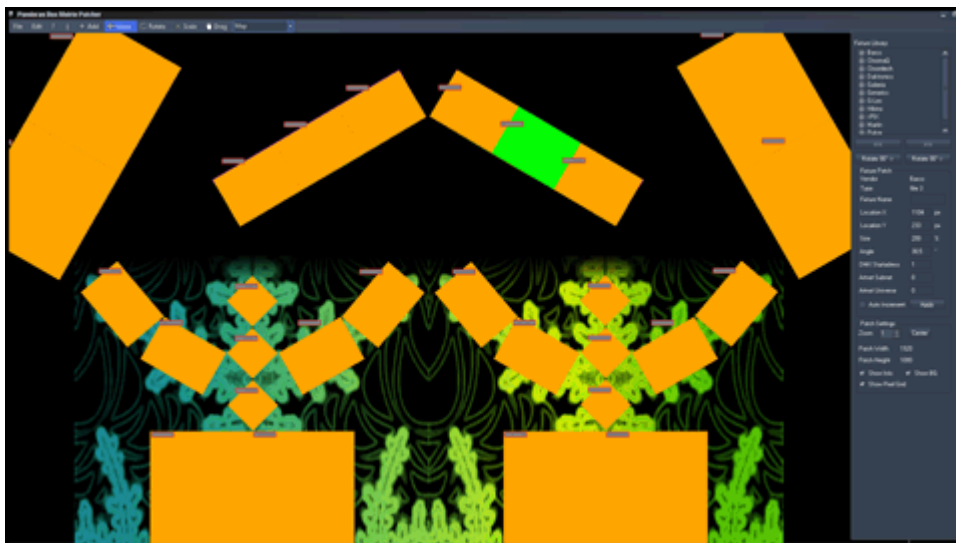

- Once you are confident with the setup, use the "Export Map" option from the File Menu in order to store the map as a png file for the ReMap FX in Pandoras Box.

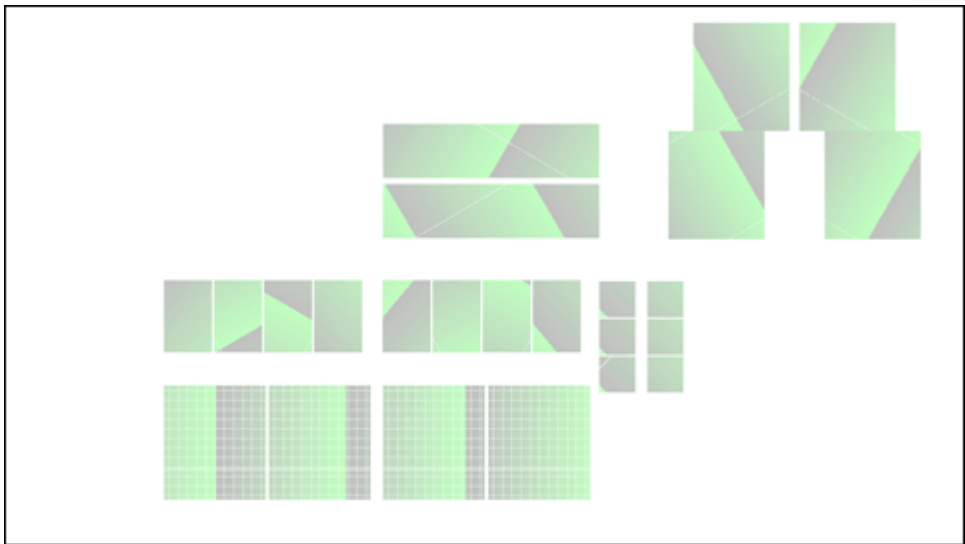

- Load the map.png into a Pandoras Box project and make sure that anisotropic filtering is turned off. To do so, click the file in the Project Tab and have a look in the File Inspector. This step is very important for the entire process !  
 The image below shows a setup up without the ReMap effect turned on.

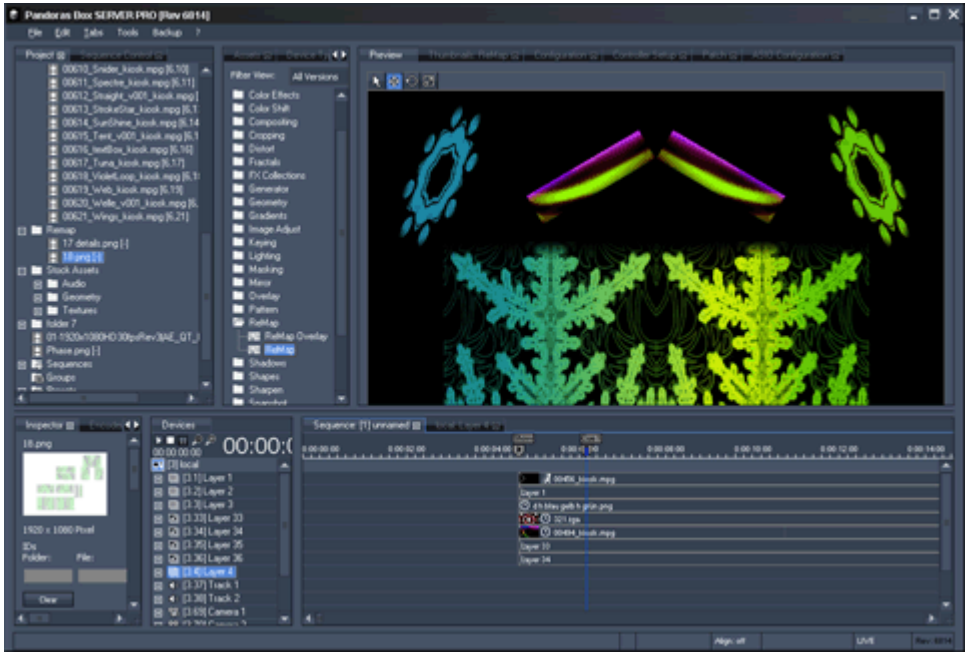

- Add the ReMap FX to the desired Output and load the Map.png into the Media Input of the [ReMap FX](#) and set the Mix to 255. Now, the pixels are routed differently as seen in the preview depicted in the image below. Note that the effect has to be assigned to an output layer and is only visible in the preview if it is set to an output view, not the global camera.

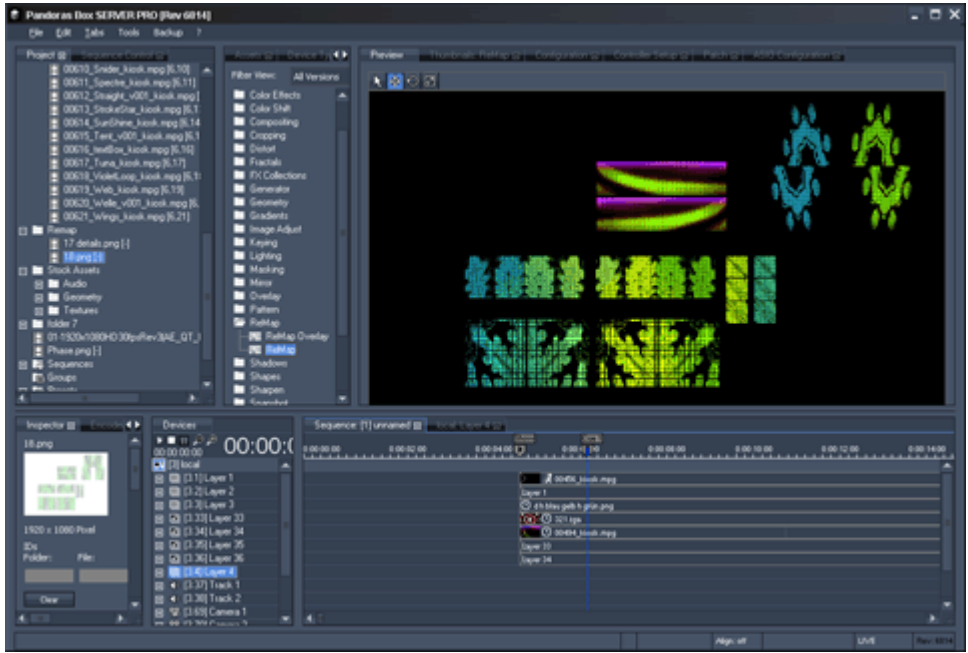

If you need to change something regarding the fixture setup in the Matrix Patcher please keep in mind that for any exported png file the anisotropic filtering must be turned off in Pandoras Box.

If you have to add one more tile to the scene or if you have to replace some of them, it is the easiest to position the few tiles in the Patch View and WITHOUT using "Initialize Map" you position them in the Map View. Keep in mind that the "Initialize Map" command resets all changes made in the Map View so far.

If you need to enlarge the entire Patch, please use the "Resize Patch" command. Do not scale the exported Map. It is very critical to keep every single pixels' information.

## 10 WARPERS

The Warper enables you to project on any screen shape. The Warper is a specialized, basic 3D modeling software using custom shapes with scalable free-form-deformers (FFD<sup>782</sup>). The application is included in the Pandoras Box installation and requires an attached dongle when started. Any PB Manager and PB Server comes with the full 3D edition. The PB Player comes with the 2D edition that has restricted features, e.g. no Z axis, object import, live warping, markers, camera settings etc. The chapter [Product Overview](#)<sup>65</sup> gives details regarding the Manager, Player and Server.

More advanced objects can be imported from many 3D modeling programs as described in the topic "[Third Party Software](#)<sup>1592</sup>".

### Solutions for projecting on bended surfaces and complex objects

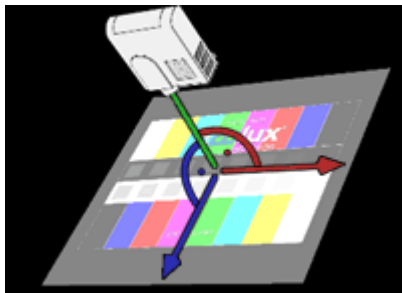

The main problem with projection surfaces that are not positioned perpendicularly to the projection axis is that the light source from the projector does not have the same distance to all projection points any more. A rectangular image is not rectangular any more and furthermore, the distances between particular points in the original image may be very different in the projected image. In short the projected image is distorted. The distortion relates to the shape of the screen (or object) and to the way the projector "looks" at it which includes the orientation and distance as well as all lens settings.

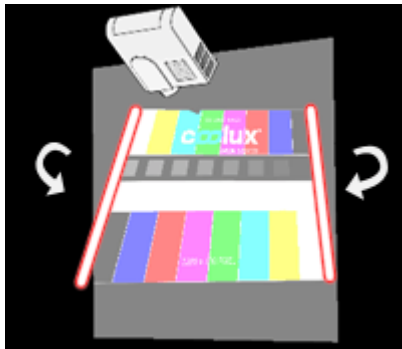

The challenge is to output an image that will look correct, considering the viewpoint of the audience. On simple planar screens, the keystone parameters for the top, bottom, left and right side of the image can already achieve a satisfactory results (see left, middle image).

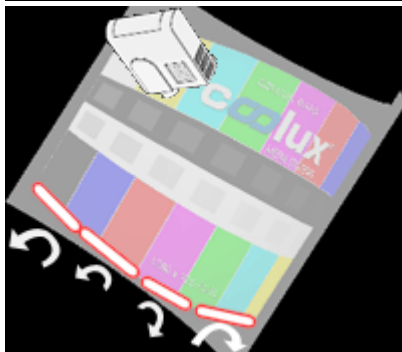

As soon as the projection surface is not a single plane anymore, e.g. it is a bended screen or a more complex object like a cube the keystoneing reaches its limit.

Those setups can be mastered in two ways. Which solution you choose depends on your setup, time as well as experience and knowledge of the team.

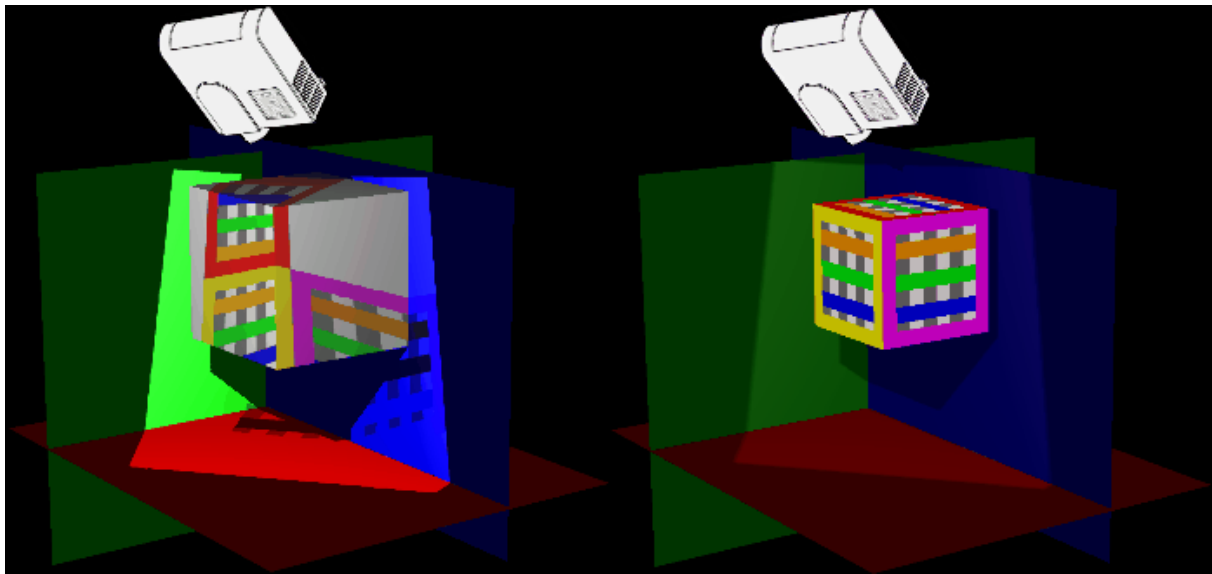

projection before ... .

... and after warping

### 2D Warping

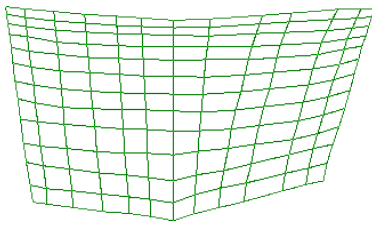

The first approach is to create a 2D plane offering for example a grid with 100 intersection points. The entire plane and each individual point can be moved, scaled and rotated until the original image is distorted in a way that the projected image looks correct. The plane is then exported as an \*.x file and applied to the [PB output layer](#)<sup>597</sup> (or another layer) and acts like a map for each pixel of the original content.

This workflow can not be prepared beforehand. It is indispensable that you work in the Warper with the real projector connected and distort the 2D image whilst looking at the real screen. When something is changed in the setup the chances are high that ALL points must be adjusted.

The advantage of the workflow is that you do not need to have any knowledge about 3D objects. You simply need to move the plane's intersection points until all lines are straight and all distances between certain points are equal. Measuring tools, tape to mark distances and (rotary) lasers can help you in that process and simplify and speed up the workflow.

### 3D Warping

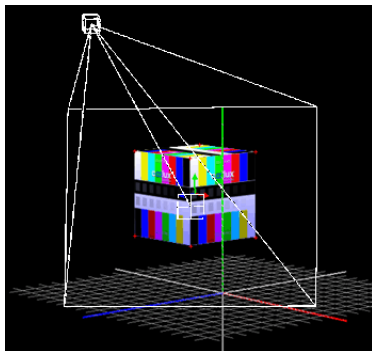

The second approach is to represent the real 3D setup as a virtual 3D setup. It includes to import a 3D object into the Warper; the 3D model must match the real screen or object as accurately as possible. Then, the virtual camera in the Warper is set up in the same way as the projector looks at the real screen. For this, you need to adjust the camera's and the object's position, orientation and lens settings. Two ways to do this are manual measurement, described in the [Camera/View tab](#)<sup>813</sup> and the automatic camera calibration based on markers, described in the [Marker tab](#)<sup>815</sup>. This feature is available since Pandoras Box version 5.5.

In addition, fine-tuning adjustments with the object's vertices can be done too. As soon as the virtual model and the virtual camera accord with the real screen and real projector the projected image looks correct.

As the final steps, the Warper's camera values are transferred to the [PB camera layer](#)<sup>589</sup> and the object is exported as an \*.x file and applied to a individual [graphic](#)<sup>577</sup> or [video layer](#)<sup>298</sup>.

This workflow can be prepared beforehand. You may for example create the screen model using a 3D modeling program like [3ds Max](#)<sup>1614</sup> and Maya from Autodesk, [blender](#)<sup>1616</sup> from Blender Foundation or CINEMA 4D from MAXON Computer GmbH. It is possible to setup the virtual settings for XYZ position of the object and the camera in accordance to available plans.

The advantage of the workflow is that you can nevertheless adopt changes conveniently. If, for example, the real setup is changed or not as accurate as scheduled you can adopt these changes easily for the virtual setup in the Warper.

For more information about how to use the Warper please refer to the following pages:

[General 3D Modeling Terms](#)<sup>782</sup>

[User Interface](#)<sup>788</sup>

[Warping Guide](#)<sup>821</sup>

[Keyboard Shortcuts](#)<sup>831</sup>

## 10.1 GENERAL 3D MODELING TERMS

This chapter covers the common 3D modeling term definitions:

- coordinate system
- generic units
- Vertices, Pivot Point, Edges and Faces
- UV texture mapping
- mesh versus FFD

Please make yourself familiar with these terms. They will be used in the following chapters when the Warper interface and workflow is being explained. As well, the explanations might help you when communicating with 3D artists who prepare 3D models for you or when getting in touch with one of the [third party applications](#)<sup>1592</sup> yourself.

### Coordinate System

Each 2D and 3D world needs a coordinate system which defines the position and orientation of each object. There are two possible systems: the right-handed and left-handed system. In both systems the positive X and Y direction are the same and show to the right and upper side (as seen in the picture below). The Z axis makes the difference, it shows either to the back or to the front.

Pandoras Box and the Warper are based on the left-handed system. If you import an object from an application that is based on another orientation make sure to adapt it.

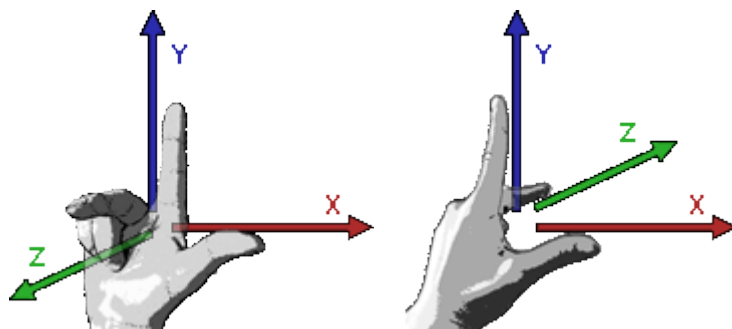

The origin of the 3D space  $(X,Y,Z) = (0,0,0)$  is situated in the exact middle of the screen when starting Pandoras Box and the Warper with default settings. The origin is the reference point for every object. The camera has a position of  $(0,0,-25)$  and a FOV (field of view = opening angle) of 35,489 degree (or 56,251 mm).

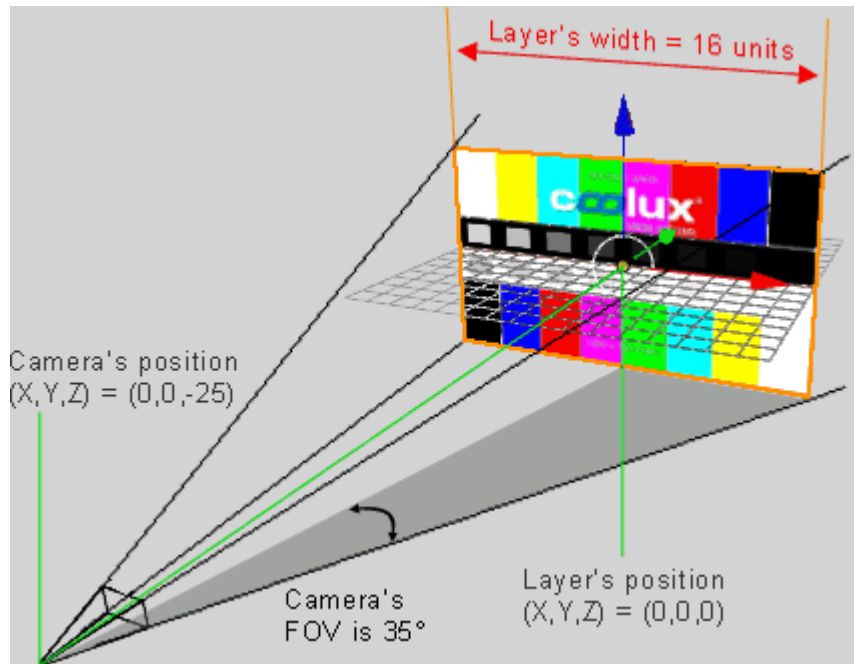

### Generic Units

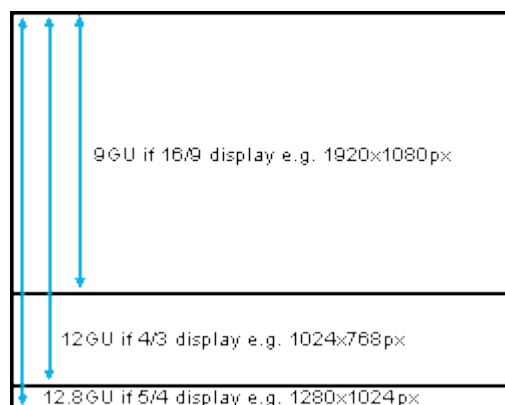

Next to the coordinate system's orientation, units are of great importance. An object has a defined position and size which is defined and saved in units.

Many 3D modeling programs can save an object with so called generic units (GU), e.g. a cube may have a height/width/depth of 8 GUs, rather than being measured in metric or pixel units. The advantage is that GUs adapt to the current screen, they "generate" a relative size and must not be scaled when the resolution changes. Per default a screen width is exactly 16 GUs, the height is calculated by the aspect ratio. Hence, a 4:3 display is 16 GUs wide and 12 GUs high, whereas a 16:9 display has the same width but a height of 9 GUs.

For example: A 3D modeler works on a 1024x768 pixel display and creates a cube that covers half of his display, i.e. it is 8GUs wide. If you import the cube into the Warper it will have the same relative size (half of *your* display) no matter which aspect ratio or resolution is chosen at your computer.

The height will always be the same size as the width, it will never be "squeezed", however it might cover less or more space than on the modelers screen.

The Warper and Pandoras Box are based on generic units since version 5. The coordinates  $(X,Y) = (0,0)$  are situated in the middle of the display. If a layer or object moves 8 units

to the right its center will be exactly on the right edge of the screen.

### Vertices, Pivot Point, Edges and Faces

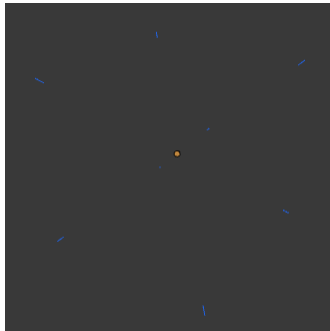

Every 3D model and geometric shape consists of corners and intersections. These special points are saved as so called "vertices" (singular: "vertex"). In a 3D space a vertex must consist of three coordinates, X,Y and Z to definitely mark the position of a corner. A cube, for example must be defined by a minimum of 8 vertices. In the example, these are the small blue points.

The default mesh in the Warper consists of vertices as well, the more mesh segments you set up, the more vertices are generated by the Warper.

In most 3D modeling programs there is a so called pivot point. In the left image it is depicted as a round orange point. The pivot starting point is the center of a transformation like rotation and scaling. If the cube is scaled, all vertices still would have the same distance to the pivot point. For more examples, please see the topics [Scale Pivot](#)<sup>313</sup> and [Rotation Pivot in Pandoras Box](#)<sup>311</sup>.

In the 3D modeling program itself you may position the pivot point where you like but please keep in mind that file formats like \*.x, \*.fbx and \*.3ds do not support pivot points. These formats always save the coordinates of the vertices as absolute coordinates. That means that the position of the object and all its vertices will be kept. But when importing the object in the Warper, the center of rotation and scaling is the center of the object itself. This cannot be influenced. Pandoras Box, on the other hand, supports pivot points itself. Thus, when importing the object, the pivot point is set to the origin of the coordinate system (0,0,0) and can be moved to the position of your choice with the parameters of the layer.

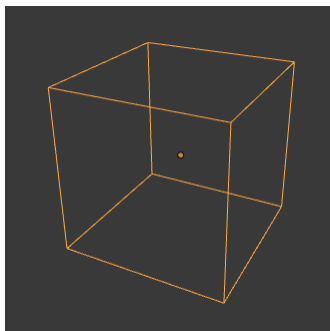

The connections between two vertices are called "edges". Here, they are depicted as orange lines. A cube consists of 12 edges.

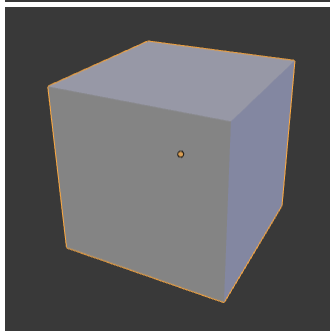

Some 3D modeling programs define that exactly three vertices make one face. Thus faces are always triangular.

The next hierarchy is then called "polygon" whereas one or more face(s) form one polygon. The outlines from a polygon are the edges. In the example image they are 6 gray squares forming a cube; 6 polygons. If faces exist, there would be at least two faces per polygon.

No matter how your 3D modeling program works, either faces or polygons can be applied with a texture.



## UV Texture Mapping

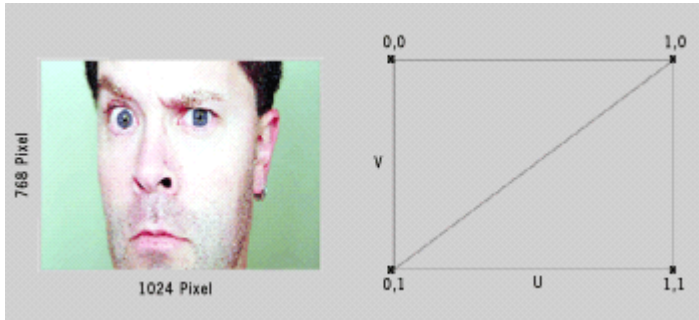
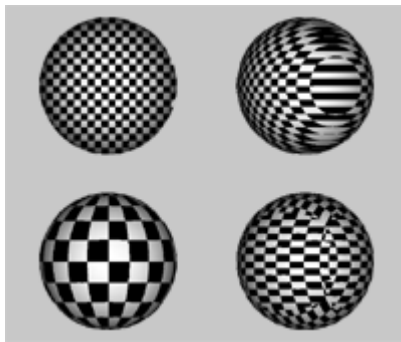

UV mapping is a process of defining how to represent a 2D image on a 3D model. The UV mapping transforms a 2D source image (in our case an image or video) into an image buffer called a texture. In contrast to "X", "Y" and "Z", which are the coordinates for the rendered 3D object, "U" and "V" are the coordinates of the texture. The UV map stores for each X,Y,Z-coordinate a defined U,V-coordinate.

This creates the effect of painting the image onto the surface of the 3D object, or in other words, how to wrap or stretch the image around the object. As explained below there are different ways how to do that, hence the chosen UV map is stored as a property of the 3D model.

If a 3D model has no UV map, neither the Warper nor Pandoras Box can paint a texture on it which leads to the fact that the object is invisible and cannot be displayed. The Warper has tools that can influence the UV Map, e.g. [scale or move it](#)<sup>807</sup>. When not importing 3D models from third party programs but working with meshes in the Warper you can define how to apply a texture on it. A texture can cover more than one mesh as well. This is described in the chapter "[Edit Menu](#)<sup>794</sup>". On the Pandoras Box side, there are [effects influencing the UV map](#)<sup>565</sup> as well.

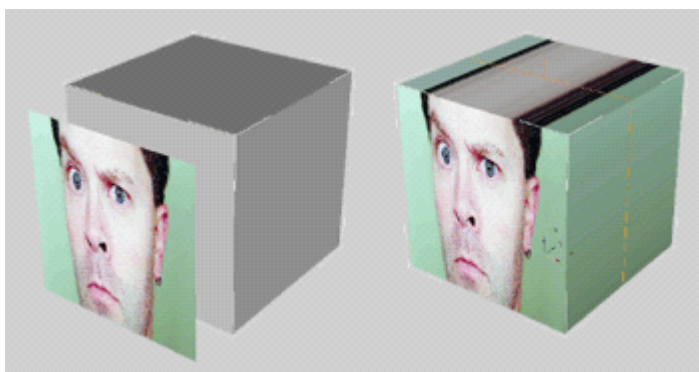

There are several standard mapping techniques available to map a texture onto an object:

- planar
- cubic or box
- cylindrical and
- spherical mapping.

Planar mapping can be referred to an image projection from one side onto an object.

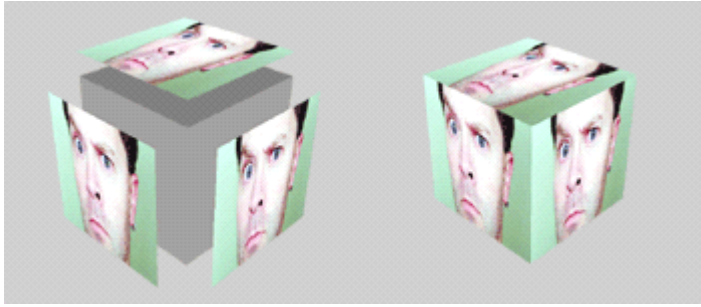

A cubic mapping for example maps the texture to all sides of an object like a box.

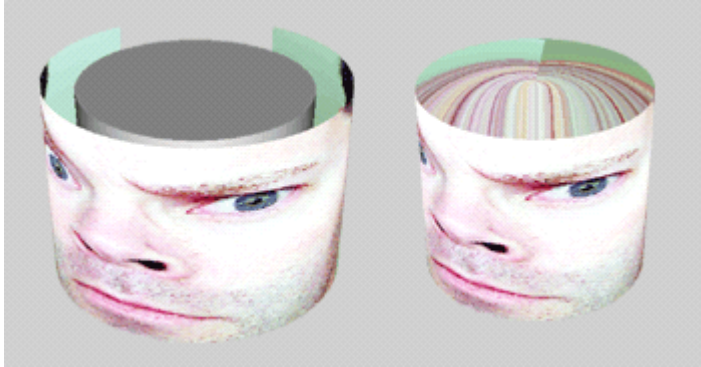

The cylindrical mapping wraps an image around an object like a cylinder, the left and right edge will join each other.

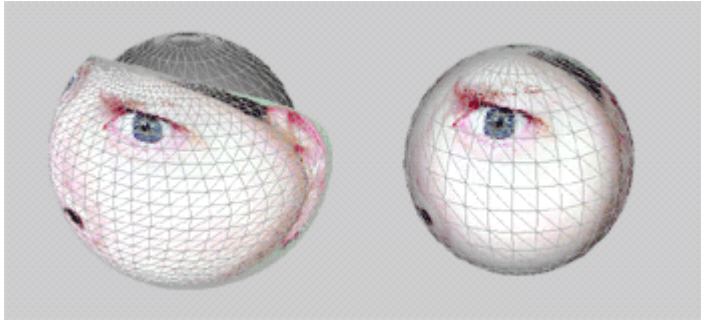

Spherical mapping wraps the image all around an object as a sphere. Please be aware that the top edge of the texture shrinks down into the top north pole and the bottom edge in the south pole.

For proper spherical mapping textures with an aspect ratio of 2:1 apply best to a spherical object.

**Mesh versus FFD**

This paragraph describes the difference between a mesh point and an FFD point, thus it is covering a fundamental function of the Warper.

The pictures below show a 2D plane with a green-colored 10x10 mesh and orange-colored 3x3 FFD.

See here the differences between moving a FFD control point and moving a mesh point. Please note that the FFD is only a helping tool to set up the mesh, you won't see the FFD in the exported object.

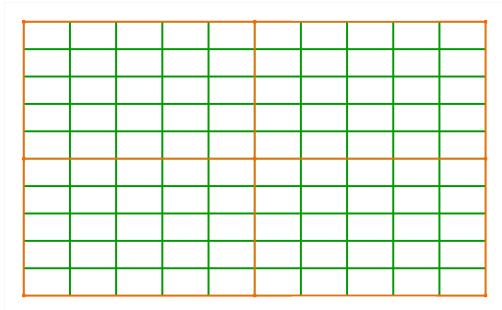

a. The grid without any editing. The green lines represent the mesh, the orange lines the FFD.

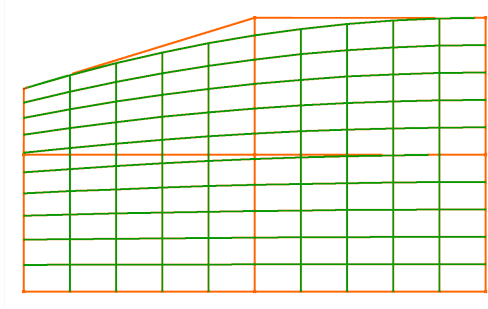

b. The top left FFD control point is moved further down. The whole mesh is affected by this change: the horizontal lines are bend together on the top left side, the meshes outline gets curved.

This effect can be of advantage or disadvantage. In the beginning of the warping process it can simplify and accelerate the workflow as it is not necessary to move each individual mesh point. The further the warping process develops the more it is necessary to apply changes to particular pixels only. At this point the FFD is not sufficient any more as it affects large areas of the grid.

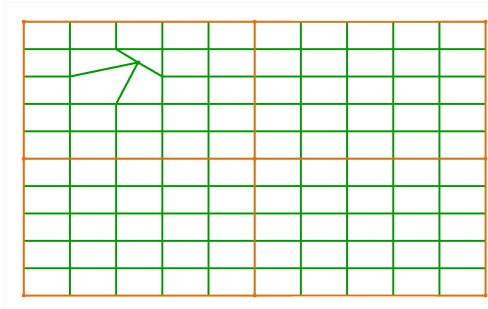

c. One mesh point is moved. Only the segment lines between the moved point and the four neighbor mesh points are affected by this.

The more you are experienced with warping the better you will be able to answer the question how many mesh points a grid should have. If too little points are chosen it won't be possible to apply the detail changes that are necessary. This is especially crucial when setting up meshes for a softedge projection as the pixels must overlap each other exactly in the overlapping area.

If too many points are chosen, the warping process is lengthened unnecessarily as all points must be adjusted.

For more information about how to use the Warper please refer to the following pages:

[User Interface](#) <sup>788</sup>

[Warping Guide](#) <sup>821</sup>

[Keyboard Shortcuts](#) <sup>831</sup>

If you are interested in other 3D modeling programs, please refer to the topic covering [third party applications](#) <sup>1592</sup>.

## 10.2 WARPED USER INTERFACE

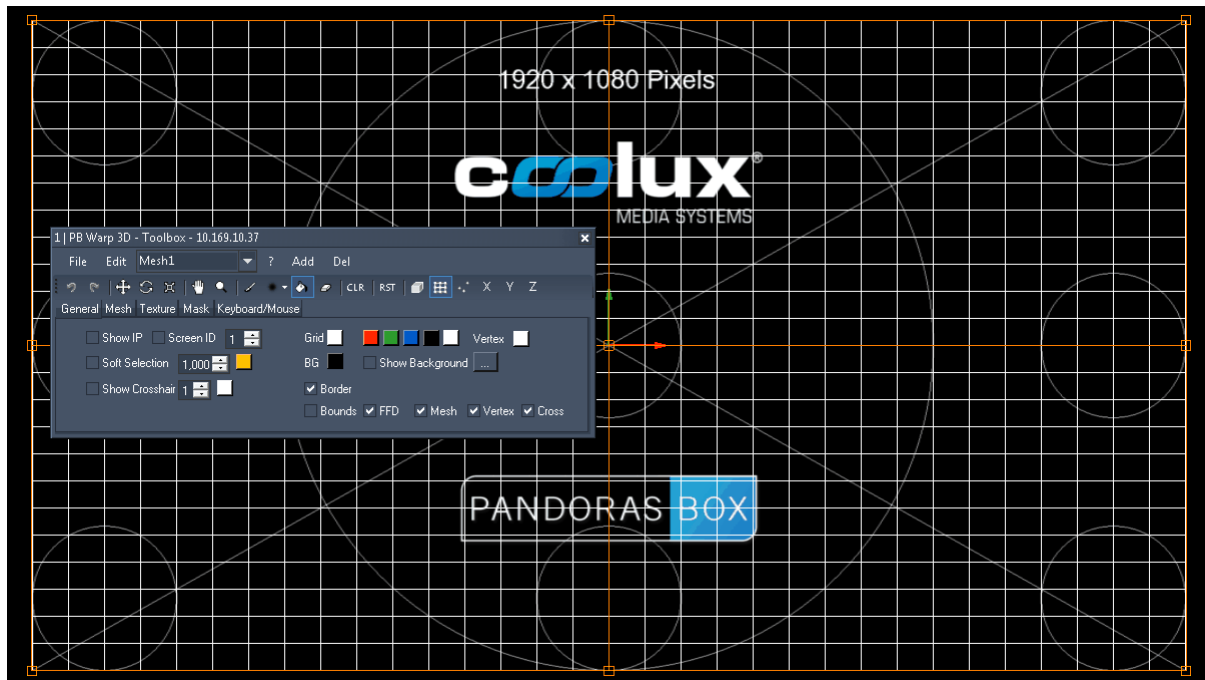

When opening the Pandoras Box Warper application in the background you will see a default 2D plane with orange lines ([FFD - Free Form Deformers](#)<sup>782</sup>) and white lines ([mesh](#)<sup>782</sup>), the grid displays a testpattern that is generated automatically according to the output resolution. How to work with the grid is explained in the chapter "[Warping Guide](#)<sup>821</sup>".

In the foreground you have a gray Toolbox, wherein you set up the grid properties and other features. Edit > Advanced Mode activates more advanced options and settings. Please note that there are differences between the 2D and 3D edition as explained in the [previous introductory chapter](#)<sup>780</sup>.

The Toolbox' title bar displays the ID of the application (e.g. "1 | PB Warp 3D") and the IP address, this is quite useful when working on several Warper windows at the same time, for example when setting up two meshes for a softedge projection. Note that the x-button closes the toolbox only (T brings it back), File > Exit closes the entire program.

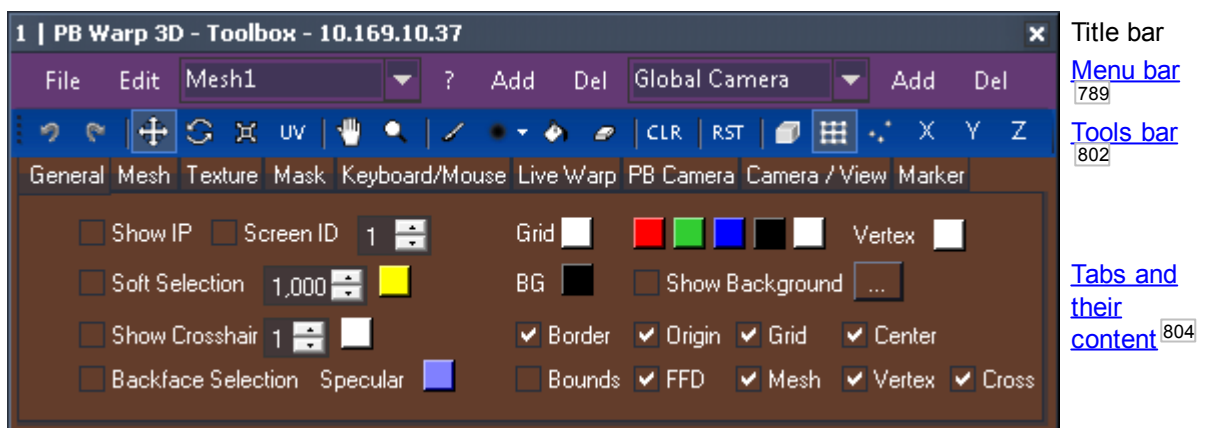

Title bar  
[Menu bar](#)<sup>789</sup>  
[Tools bar](#)<sup>802</sup>  
[Tabs and their content](#)<sup>804</sup>

## 10.2.1 MENU BAR

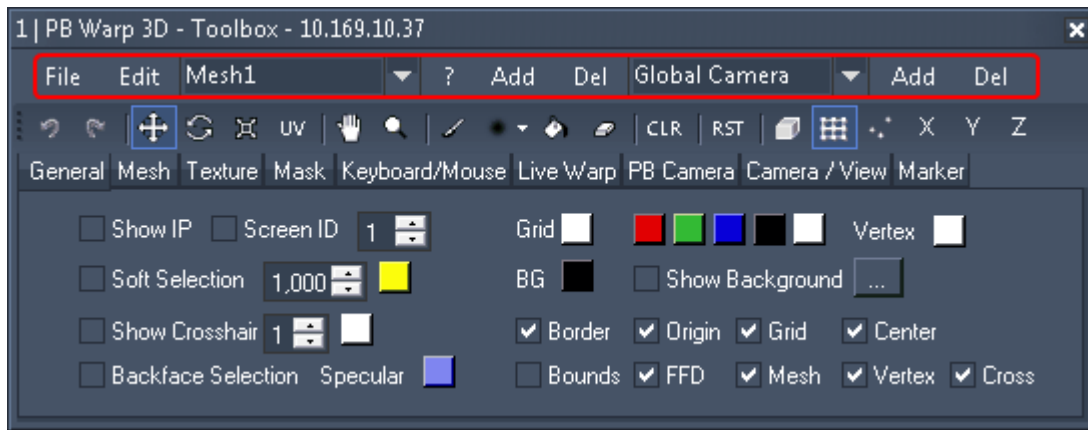

The Menu Bar is divided into the [File Menu](#)<sup>789</sup>, the [Edit Menu](#)<sup>794</sup>, the [Mesh Selection](#)<sup>801</sup> and [\[?\]-Button](#)<sup>801</sup> and the [Camera Selection](#)<sup>801</sup>.

### 10.2.1.1 FILE MENU

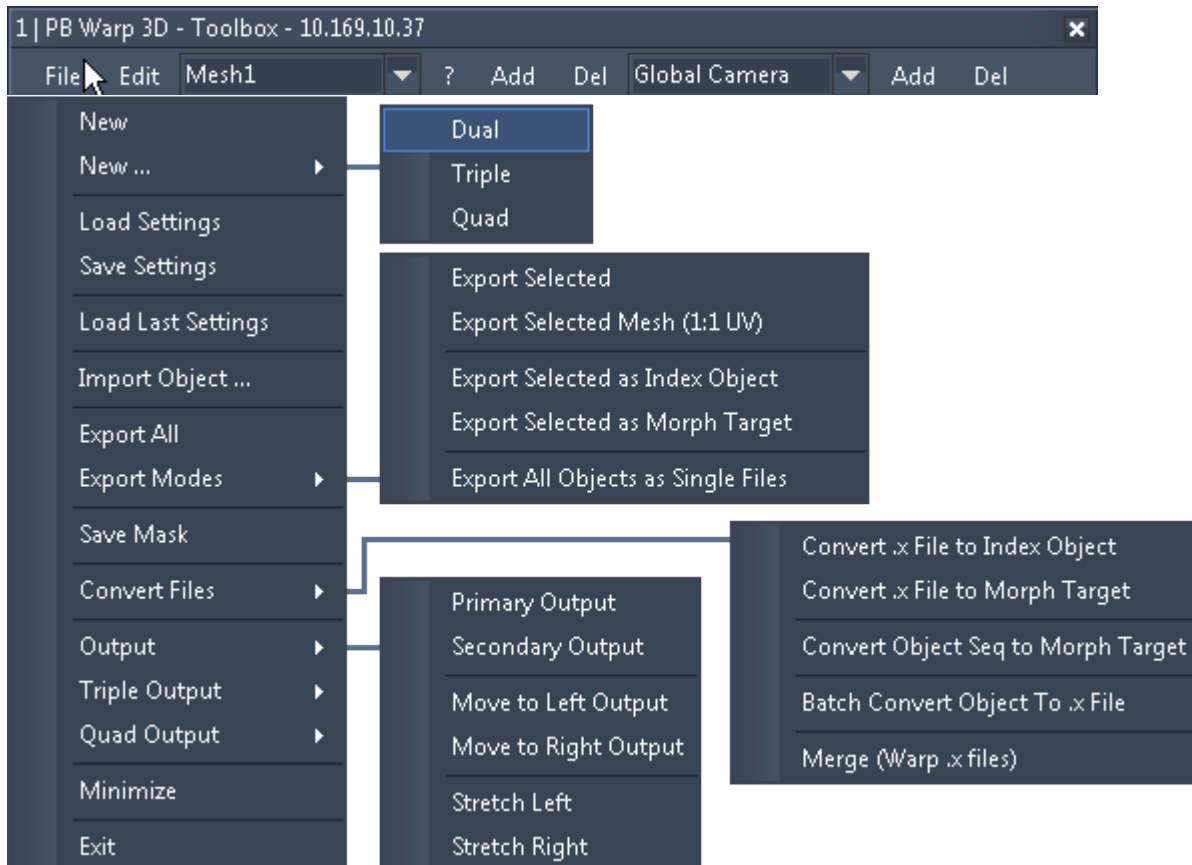

The depicted menu is the advanced one. Per default, the basic menu is shown, to get access to all options, go to Edit > Advanced mode

**New**

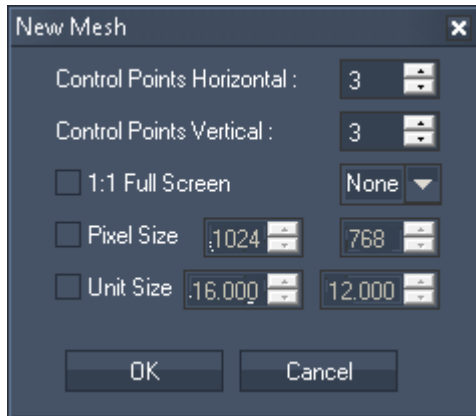

**NEW**

When creating a new file, this dialog box opens up. Please note that this will close your current project. (In case you simply like to add another mesh, click the [Add Button](#)<sup>801</sup> next to the mesh selection drop-down list.)

Decide how many horizontal and vertical FFD control points should be applied. How many to choose depends on the shape of the screen you need to warp. For more details, there is a [tutorial](#)<sup>821</sup> at the end of the Warper chapter.

Tick the check box [1:1 Full Screen Start Size] if the new mesh should cover the complete output instead of keeping a small border uncovered. You may as well decide what aspect ratio the new fullscreen grid will have. The width of 16 [generic units](#)<sup>783</sup> will always cover the current output screen's width.

If you decide for a pixel size please note that it will generate values relative to your local output resolution and aspect ratio and will apply them to the object. For example: if you are working on a 1920x1080px display and choose a 1024x768px mesh, the new plane will have a width of 8.533 generic units (16GU \* 1024/1920) and a height of 6.4 GU (9GU \* 768/1080). Defining a unit size for the width and height will apply those generic units directly.

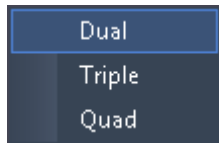

**NEW...**

Again, this option will close your current project.

Choosing "Dual / Triple / Quad" will generate two / three / four new meshes (on the screen that is set to be the primary monitor). There is a UV Map covering all meshes.

This option is very useful when working with a device that splits *one* output into several parts. If you use this device in a softedge projection, it is recommended to create special testpatterns with a grid that is colored differently per region. That allows you to see if the warped meshes overlay each other pixel per pixel. Alternatively you may open the Warper several times and use the [Triple / Quad option](#)<sup>794</sup> as described below.

The settings offered in the dialog box are the same as explained in the previous paragraph.

**Load and Save Settings**

**LOAD SETTINGS**

If you want to load an existing warping file (\*.wrp), choose the directory and file name in the opening dialog .

**SAVE SETTINGS**

Choose the directory and file name in the saving dialog to save your warping file (\*.wrp). In contrast to an exported \*.x file object, the warping file includes all internal settings like FFD points, the Mask and all other Warper settings. It is recommended to always save in this format as well.

## LOAD LAST SETTINGS

Check this option if you like to load the last project as soon as the Warper is started.

## Import Object

This command allows to import an object from [another 3D modeling program](#)<sup>1592</sup>. A pop-up asks whether you like to merge the imported object, i.e. include it into your current setup. If "No" is chosen your current project file closes and a new project is opened containing nothing but the imported 3D object.

Choose the directory and file name in the opening dialog. The following formats are supported:

- \*.3ds
- \*.fbx
- \*.obj
- \*.x

If your object is larger than 16 [generic units](#)<sup>783</sup> a pop-up lets you rescale the object. Though, due to possible rounding errors, it is recommended to scale the object in the software it was originally created with.

Please note that \*.x files can be written by many exporters and sometimes the same data is written differently. The build-in importer is optimized to work with the [exporters provided by coolux](#)<sup>1592</sup>. Importing files from other exporters could result in changed orientations, normals,...

## Export Modes

### EXPORT ALL

Use this export option to export all meshes as one \*.x file.

For example, if you have created two meshes and use the "Export All" option the resulting \*.x file will behave as follows. Both meshes are covered with the same texture. If applied to a layer in Pandoras Box its media will be displayed twice, according to the scaling and the position of the two meshes. If applied to an output layer, everything that is seen by the camera layer will again, be displayed twice.

Choose the directory and file name in the saving dialog to save all meshes as one scene.

### EXPORT SELECTED

Use this export option to export *only the selected* mesh as an \*.x file.

In contrast to the above option you may now export each mesh individually and apply it to different video or graphic layers or different output layers.

Choose the directory and individual file name in the saving dialog to save only the selected mesh.

Please note: Changes done to the UV texture mapping (by editing the texture's Zoom or Offset settings in the [Mesh tab](#)<sup>807</sup>) will be included in the exported file. This will influence the size or position of a texture used with this object in Pandoras Box as well! If you want to have the whole texture mapped on the object, please use the option "Export Selected (1:1 UV)" instead.

Example: The left image below shows a mesh in the Warper. The texture mapping has been modified to see only a part of the testpattern. After having exported this file via the option "Export Selected", in Pandoras Box (depicted in the right image) the object's texture will look corresponding to texture in the Warper.

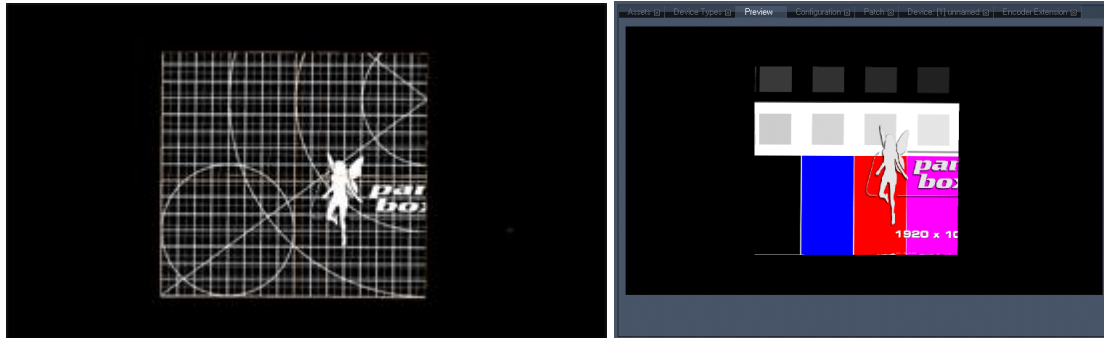

**EXPORT SELECTED MESH (1:1 UV)**

Use this export option to export the selected mesh as an \*.x file without the changes done in the [Mesh tab](#)<sup>807</sup>.

In contrast to the above option any texture's Zoom or Offset settings will not be included in the exported file - the UV map is applied with the original 1:1 setting. When the mesh is applied to a graphic, video or output layer (depicted right) the object's texture will look different to the texture in the Warper (shown left).

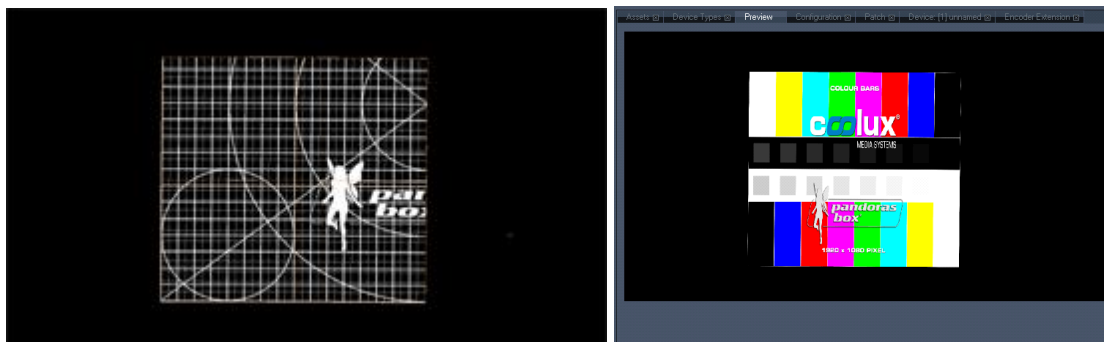

**EXPORT SELECTED AS INDEX OBJECT**

Use this export option to export the selected mesh as an index object (\*.x file) to be used for morphing or live warping within Pandoras Box.

Choose the directory and file name in the saving dialog to save the index object. In Pandoras Box, the index object can be used as any other object on a video, graphic or output layer. Please refer to this chapter to learn more about [morphing and live warping](#)<sup>828</sup>.

Please note that a new index file must be exported each time when the FFD and mesh count is changed.

If you like convert an external \*.x file to an index object please use the option "Convert .x File to Index Object".

**EXPORT SELECTED AS MORPH TARGET**

Use this export option to export the selected mesh or 3D object and its current look as a morph target (\*.x file) to be used for morphing within Pandoras Box.

Choose the directory and file name in the saving dialog to save the morph state. Then you may alter the mesh / object deformation and save this as a new morph target. In Pandoras Box, the morph objects can be used as effect media files for various morph effects. Please refer to this chapter to learn more about [morphing and live warping](#)<sup>828</sup>.

Please note that a mesh / object used for morphing should not be placed outside the area that reaches from -32 to +32 generic units.

If you like convert an external \*.x file to a morph target please use the option "Convert .x File to Morph Target".



## EXPORT ALL OBJECTS AS SINGLE FILES

Use this export option to save each 3D objects from your scene as individual \*.x files. Choose the directory and folder name in the saving dialog. Automatically, the files are named with a consecutive name like "3ds Obj1.x" and "3ds Obj2.x".

## Save Mask

Use this option to export the screen mask you created in the ScreenMask tab.

Choose the directory and file name in the saving dialog to save the mask as a \*.png file, which can be inserted in your Pandoras Box project and used as a mask object on a layer. [Read more...](#)<sup>810</sup>

## Convert Files

### CONVERT .X FILE TO INDEX OBJECT

### CONVERT .X FILE TO MORPH TARGET

The above described options "Export Selected as Index Object" and "... as Morph Target" refer to an object made within the Warper. If you have exported your object from another third party program as an \*.x file and you like to use it for morphing and live warping within Pandoras Box please use the "Convert..." option.

First, choose the directory and file name from your external \*.x file in the opening dialog. Then, choose the directory and file name for the converted index object (or converted morph target) in the saving dialog. Please refer to this chapter to learn more about [morphing and live warping](#)<sup>828</sup>.

### CONVERT OBJECT SEQ TO MORPH TARGET

Some programs can export a movement from objects as an object sequence - a folder consisting of several \*.3ds, .obj or .x files. To convert all of them in one step to be used as a morph target, choose this option.

An opening dialog opens where you can navigate to the folder and multi-select all object files that should be converted. If needed, set a resizing factor. A progress bar is shown in the right upper corner of the menu. Each object is converted to a \*.png file, the new name consists of a consecutive number followed by the original name. The image files are automatically saved in the same folder.

As a next step you might copy those images into a new folder that can be used as an image sequence in Pandoras Box, for example on the Aeon Effect "[Warp Target](#)<sup>576</sup>" in the folder "Warp" or "[Morph A-B-C](#)<sup>420</sup>" in the folder "Geometry". In order to save performance, you may convert the \*.png files as well into an \*.avi video file, e.g. using the coolux tool [Image Converter](#)<sup>838</sup> or to a lossless video format from the [coolux codec](#)<sup>115</sup>.

### BATCH CONVERT OBJECT TO .X FILE

Some programs can export a movement from objects as an object sequence - a folder consisting of several \*.3ds, .obj or .x files. This command allows to convert all of them to \*.x files in one step.

An opening dialog opens where you can navigate to the folder and multi-select all object files that should be converted. If needed, set a resizing factor. A progress bar is shown in the right upper corner of the menu. Each object is converted to an \*.x file, the original name is not changed. The files are automatically saved in the same folder and can now be imported in Pandoras Box.

### MERGE (WARP .X FILES)

This option enables you to merge several warping files (\*.x files) into one file.

In the dialog, browse to the folder and select all files you want to merge. A new dialog opens asking you under what name and whereto the merged file should be saved. The merged object may now be imported in Pandoras Box or the Warper itself.

This option might be useful when you already exported separate meshes instead of using the "Export all" option.

## Output

### PRIMARY / SECONDARY OUTPUT

By default the warping grid opens on your primary output.

When you have two outputs and the graphic card is in "Extended Mode" mode / "Dual View", please use this option to position the Warper's mesh on the left or right output. This is contrary to the below described graphic card setting "Horizontal Stretch".

You may open the Warper application twice whilst the first is positioned on the primary output and the second on the secondary output. This has the advantage of working on both outputs simultaneously.

### MOVE TO LEFT / RIGHT OUTPUT

Choose these options if you are working with a stretched desktop consisting of more than one "display area" in order to move the warping area one step further.

### STRETCH LEFT / RIGHT

When you have two outputs and the graphic card is in "Horizontal Stretch" mode (recommended display mode for soft edge projection), please use this option to position the Warper's mesh on the left or right half. This is contrary to the above described graphic card setting "Extended Mode" mode / "Dual View".

## Triple Output and Quad Output

This command is useful when having three or four outputs, for example whilst working with a QUAD SERVER and using the DVI Processor that splits the desktop into numerous outputs. Open the Warper application and send it to Quad Output 1, then open the Warper 3 more times and send each to another quarter of your screen. Now you may work on all meshes simultaneously.

Alternatively you may open the Warper only once and work on several meshes using the [New... command](#)<sup>[790]</sup> as described above.

## Minimize

Minimizes the Warper window. As the Toolbox always stays in the foreground you have to close it as well or just press [H] to hide it.

## Exit

Quits the application. A dialog box will appear and ask you if you want to save the project before closing. Choose [Yes] to save it, [No] for exiting without saving or [Cancel] to get back to the application.

### 10.2.1.2 EDIT MENU

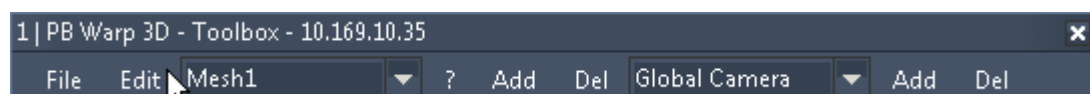

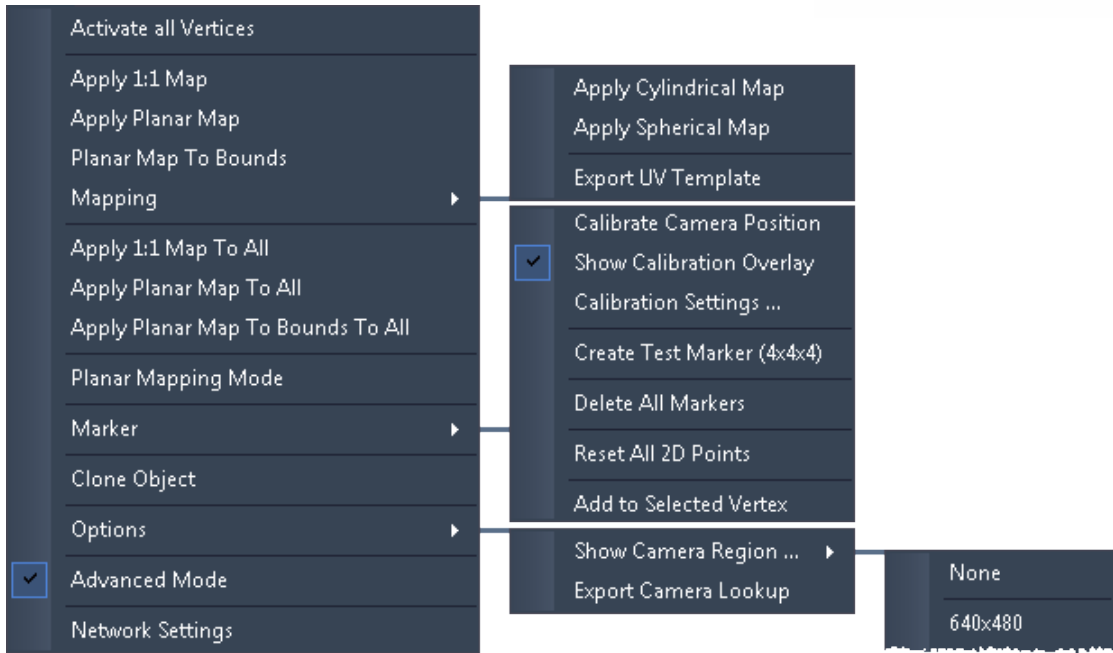

### Activate all Vertices

If you toggled some vertices/faces of the mesh with the shortcut [D] to be invisible, you can activate all hidden vertices again using this menu entry.

### Apply Map and Mapping

The following commands change the UV texture map for generated planes and objects. If you are not familiar with UV mapping, the chapter "[General 3D modeling terms](#)<sup>785</sup>" includes a short section covering it and can get you started with that important 3D modelling technique. The [Mesh tab](#)<sup>807</sup> allows to offset and zoom a previously applied UV map.

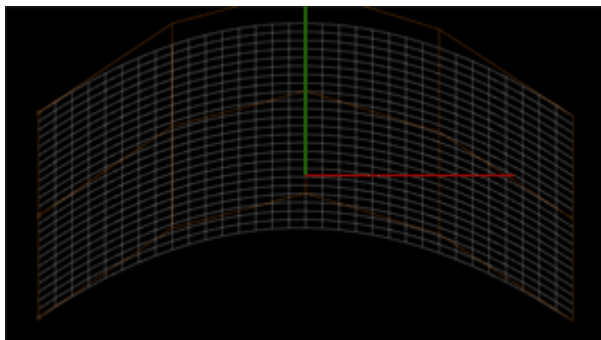

The depicted example shows one single mesh that was bended by using the FFD.

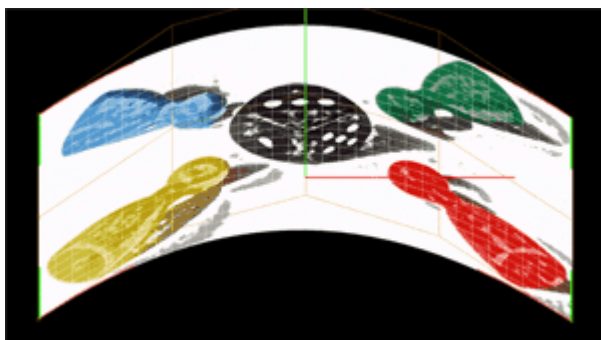

#### APPLY 1:1 MAP

In the Texture tab you may find the button "Load Texture...". It applies a texture 1:1 like, that is, the texture is scaled and deformed to fit exactly into the corners of the mesh. The command "Apply 1:1 Map" always brings you back to that state. It applies a texture to the currently selected mesh or object.

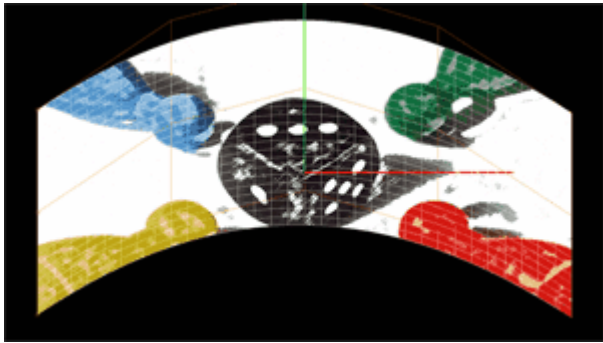

#### APPLY PLANAR MAP

This command applies the texture to the selected mesh in a way that it is first scaled to the current fullscreen resolution and then applied to the mesh without being influenced by its scaling, position or deformation. It stays planar.

One could imagine that the fullscreen texture is projected and burned into the mesh. If you now deform the mesh further, the deformation applies to the texture as well. If this is not required you may apply a planar map again.

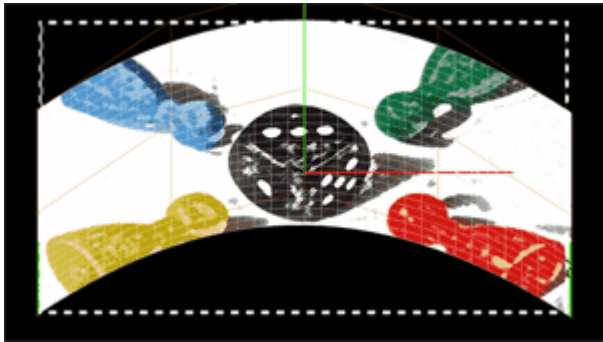

#### PLANAR MAP TO BOUNDS

This command applies the texture to the selected mesh in a way that it is first positioned and scaled to the bounds of the mesh. The size of the mesh is indicated in the left image by the white dashed line. Then the texture is applied to the mesh without being influenced by its deformation. It stays planar. One could imagine that the resized texture is projected and burned into the mesh. If you now deform the mesh further, the deformation applies to the texture as well. If this is not required you may apply a planar map again.

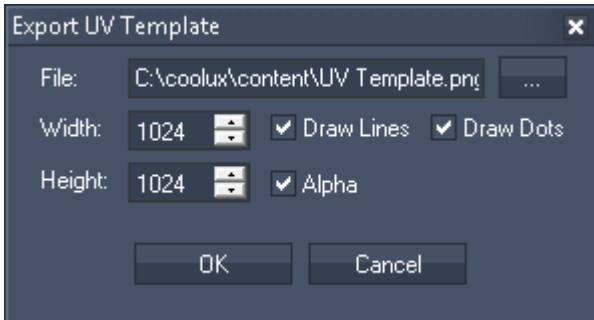

#### MAPPING

If you are working with cylinder and sphere objects, select the object and apply the according special mapping techniques. The available ones include a cylindrical and spherical mapping. For more information please read the chapter "[General 3D modeling terms](#)<sup>785</sup>". Please note that the mapping technique expects the object to be positioned at  $(X,Y,Z) = (0,0,0)$ .

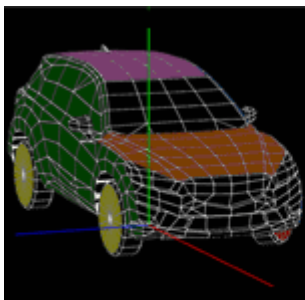

an imported object with a texture that has been partly colored



an UV template can be used in any graphics editing software

The command "Export UV Template" generates a template that can be used for creating content that should be mapped on the object. The feature unfolds an object, the result is a 2D image that can be colored in and later used as a texture on the object. For modifying the UV template you may use any graphics editing software of your choice as the UV template is saved as a \*.png file.

In the dialog click the [...] button to choose the directory where the \*.png image should be saved. The ideal width and height of the UV template depend on the object. The higher the resolution the more details can be shown but the more performance is drawn.

"Draw Lines" will show the edges of the faces. In the Warper you can not see faces, but the larger polygons when activating the Wireframe mode in the [Texture tab](#)<sup>808</sup>.

"Draw Dots" refers to the vertices themselves which

are shown as red crosses when activating them in the [General tab](#)<sup>805</sup>.

If ticking the "Alpha" check box there will a transparent background instead of a black background. Vertices and edges are always white.

## Apply Map to All

A UV map can cover several meshes and objects at the same time, that is, it applies to one mesh only partly. This is for example of interest when...

- 1) you like to show one layer on two separated screens
- 2) you have a complex screen that could be divided into several regions in order to make the warping process easier and faster. Imagine, that you want to project on a facade. Everything should be covered by the same picture. The facade probably consists of areas that are differently complex. Maybe there are quite plane areas and others, that need some more warping, e.g round pillars or stucco decoration. On these areas you can place meshes with a finer mesh grid and more FFD points. On the easier parts you can place more rough meshes. The alternative would be, that everything is covered by a mesh that has everywhere the same fine grid resolution. This would mean that you spend a lot of time on the easier parts too, as you have to work with unnecessary mesh points.

For both applications the following mapping commands can be helpful. For understanding the meaning and potential of planar mapping it is recommended to build some examples and try it out practically.

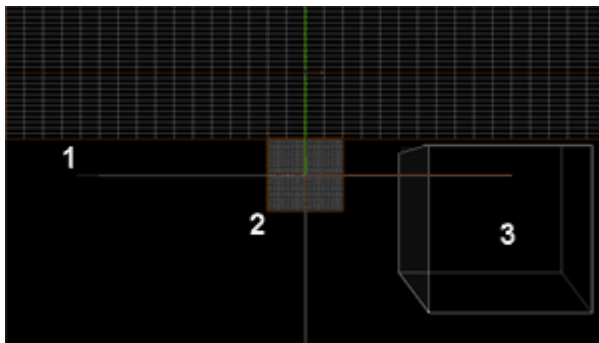

As an example, let's take this setup. At the top, there is one large mesh, a 2D plane, covering the entire fullscreen width. In the middle, there is another mesh, a square like 2D plane. As a third object, a cube has been imported as an \*.x-file and is positioned in the bottom right corner. The camera stays at the default position at (X,Y,Z) = (0,0,-25).

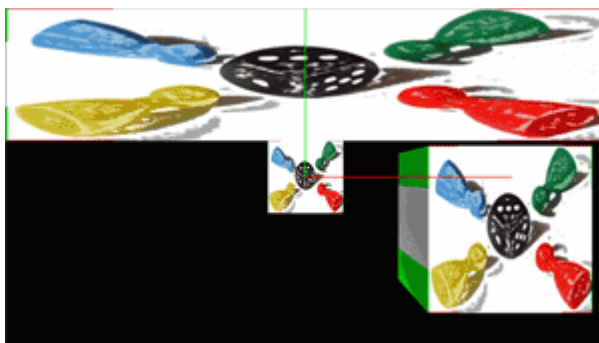

### APPLY 1:1 MAP TO ALL

In the Texture tab you may find the button "Load Texture...". It applies a texture 1:1 like, that is, the texture is scaled and deformed to fit exactly onto each mesh and object that exists in your project. You do not need to select a mesh or object first. The command "Apply 1:1 Map To All" always brings you back to that state. As seen in the cube object, the texture is applied in a planar way, the front face shows the image, the side face stretches the left pixel line. The same is happening on the right, top and bottom side.

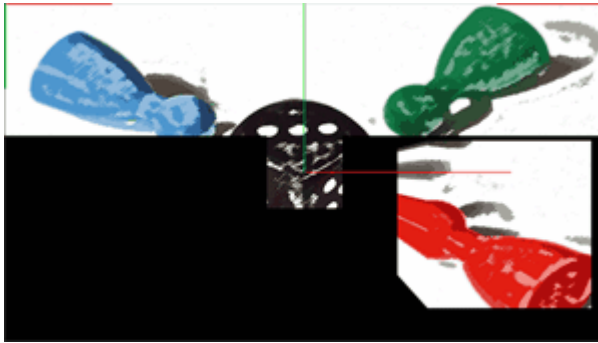

#### APPLY PLANAR MAP TO ALL

This command applies the texture to all meshes and objects in a way that it is first scaled to the current fullscreen resolution and then applied to them without being influenced by their scaling, position or deformation. It stays planar. One could imagine that the fullscreen texture is projected and burned into the meshes. If you now deform the meshes further, the deformation applies to the part of the texture as well. If this is not required you may apply a planar map again.

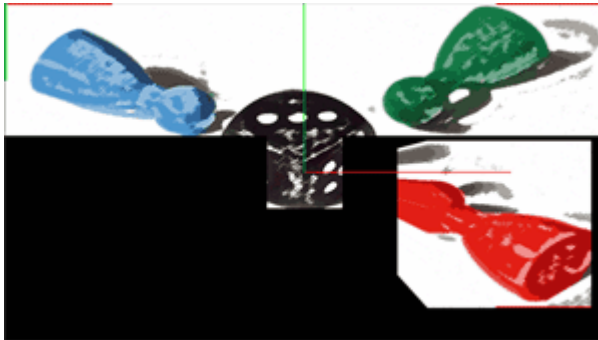

#### APPLY PLANAR MAP TO BOUNDS TO ALL

This command applies the texture to all meshes and objects in a way that it is first positioned and scaled to the bounds of the meshes. This can be best seen in the above described section "Planar Map To Bounds" where the size is indicated by a white dashed line.

Then the texture is applied to the meshes without being influenced by their deformation. It stays planar.

One could imagine that the resized texture is projected and burned into the meshes. If you now deform the meshes further, the deformation applies to the part of the texture as well. If this is not required you may apply a planar map again.

## Planar Mapping Mode

An activated Planar Mapping Mode applies the chosen texture constantly onto all meshes and objects in the project. The texture is not influenced by their scaling, position or deformation, it stays planar until the mode is deactivated again.

This is useful for positioning and scaling meshes *before* the Warping process as described [above](#)<sup>797</sup>.

## Marker

Please find a general description of markers in the topic describing the [Marker tab](#)<sup>815</sup>.

### SHOW CALIBRATION OVERLAY

An activated Calibration Overlay is the default state. If you deactivate this option, the object will always be rendered in the Wireframe mode (i.e. the texture will be hidden) as soon as you enter the Calibration mode when working with Markers. This is useful when you want to position a marker without being distracted by the texture.

### CALIBRATION SETTINGS

A new dialog opens where you can influence the calculation that is called to estimate the camera position after setting up [markers](#)<sup>815</sup>. The calculation is based on an algorithm that runs a defined number of times until it finds a position for which the two instances of all markers match each other, allowing a certain accuracy. If the result does not meet your expectations you can set up, that the algorithm should run more often, e.g. to reach the expected accuracy. Whether a more accurate (less than 0.00010) calculation or a more tolerant one gives better results, depends on your setup.

### CREATE TEST MARKER

This command creates four markers that can be used to estimate a camera position automatically as described in the [Marker tab](#)<sup>815</sup>.

### DELETE ALL MARKERS

Choose this command if you like to delete all [markers](#)<sup>815</sup>.

### RESET ALL 2D POINTS

After adding a marker to the project, a 3D point and a 2D point are generated. You may relocate the second instance, the 2D point, onto the real object (in the projected image). Choose "Reset All 2D Points" to discard this reposition and bring back the second instance. According to the current view, the 3D point and the 2D point share the same position again.

### ADD TO SELECTED VERTEX

First, select a vertex from your 3D object, then choose this command in order to attach a marker to it. Instead of this workflow you may as well add a marker using the [Marker tab](#)<sup>815</sup>.

## Clone Object

The command "Clone Object" allows to make a copy from the currently selected 3D object or 2D plane. If you are in the FFD mode, please make sure that all FFDs are selected. If you are in the Object mode, just select the object or plane that should be copied. Now, go into the Move mode and drag the object whilst holding down the right mouse key.

## Options

In the Options menu you may find settings of interest when working with a camera tracking. A problem that you might encounter is, that the image seen by the camera is distorted due to a non-orthogonal camera position or due to lens deformation, the so called cushion effect. Same as with projectors, the (input) image needs to be keystoneed or even warped. This is especially needed if the projector(s) is (are) not positioned on the same axis and output the image in a different angle.

The goal is, that the input coordinate of a tracked point can be translated into an output coordinate.

First, open the Warper on the computer where your Camera is attached to. On the default mesh, apply the video input image as a texture. You may do this in the [Texture tab](#)<sup>808</sup>. Now, open the Options menu and choose in the command "Show Camera Region" your camera resolution. Relative to your local screen resolution, a blue rectangle marks the camera size. Depending on the camera position and how it records the scene you need to deform the mesh in order to have a straightened tracked region as if the camera would look straight onto it without lens deformation, see the example depicted left. As a last step in the Warper, choose "Export Camera Lookup" and the directory whereto the \*.dat file should be saved.

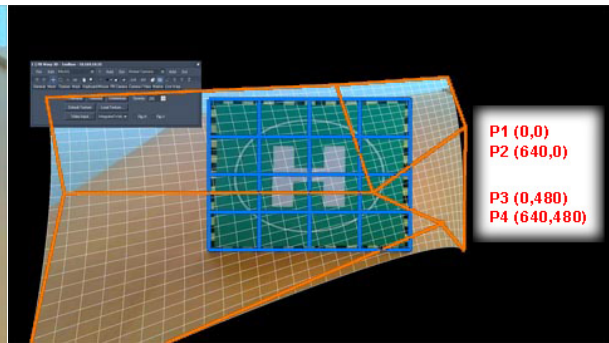
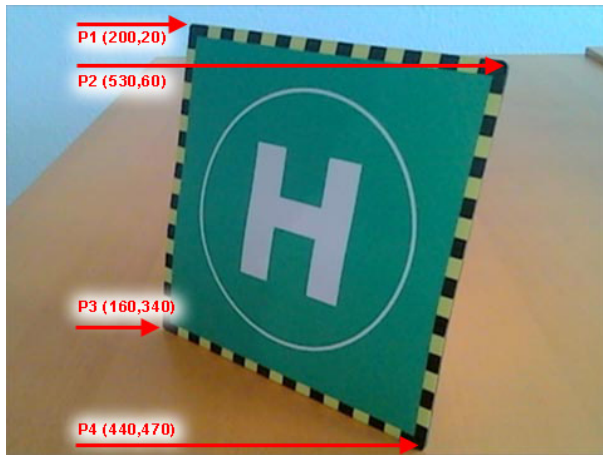

The camera records 640x480 px but the position is not orthogonal to the region that should be tracked. The corner points have coordinates that depend on the camera position. If a projector is not positioned where the camera is, it is very complicated to project a layer at the exact position from a tracked point. The input image needs to be keystone and transformed.

The screen resolution in this example is 1920x1080 px. The camera region (the blue rectangle) is set up to match the input resolution of 640x480 px. The mesh's texture shows the Live Input. Then the FFD is used to deform it in a way that the tracked region fits the camera region. This is the same result as if the camera would have been installed at an ideal position.

With the lookup table, the tracked input coordinates can be translated into valuable output coordinates (for a layer).

Now, the lookup table can be used in the [Widget Designer](#)<sup>864</sup> for example. In the [Camera Point Tracker tool](#)<sup>1224</sup> you may find the check box "Use Lookup". Click the [...] button to choose the directory from the saved \*.dat file. Press the "Apply" button.

If a person now walks along the top edge for example, the tracked camera point will report a movement in one axis only, e.g. from (X,Y) = (0,0) to (640,0). Without the lookup table the same movement would have resulted in an X position change and Y position change, e.g. (200,20) to (530,60). It would have been impossible to prepare a Widget Designer project without knowing the exact camera position and how the input image looks like. With the lookup table you may straighten the image according to the camera position and use prepared [Region nodes](#)<sup>1070</sup> or [Custom Script Buttons](#)<sup>884</sup> that are positioned in certain areas on your page. For example you can take a draft image from the scene and use it as a [background image](#)<sup>880</sup> for your Widget Designer page. With the lookup table you can as well use the [Camera Input node](#)<sup>992</sup> and route the X,Y Pos directly into a [Range node](#)<sup>1084</sup> and [PB Device Output node](#)<sup>1122</sup> without further calculation.

### Advanced Mode

The Warper application starts per default in a basic mode, that is, certain menus, commands and tabs are hidden. Activate the advanced mode if you like to have access to all functions of the Warper.

### Network Settings

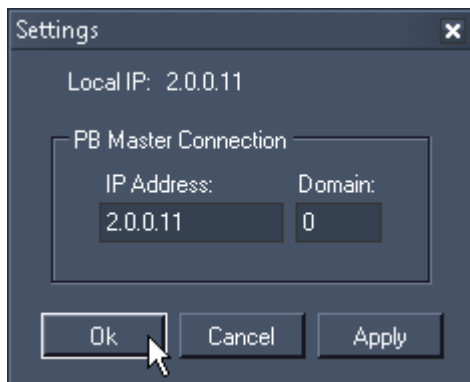

If you're running the Warper on the same computer as your PB Master software (Manager, Player or Server), the exported mesh or mask can directly be added into your current PB Project. To use this function, please make sure that the IP address and Domain of your local computer match the PB Masters settings.

The next time you export a mesh or mask, it will be added to your Pandoras Box project automatically.



### 10.2.1.3 MESH SELECTION

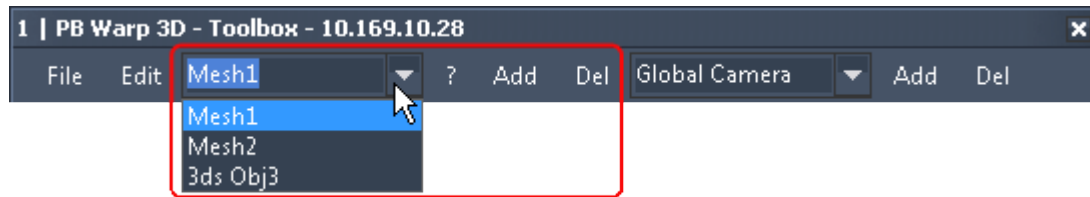

The Warper allows to deal with several mesh objects or 2D / 3D objects within one warping project. Choosing one of the existing objects from the drop-down list will select the object in the main window. Alternatively you may go into the ["Object mode"](#)<sup>802</sup> (e.g. via the shortcut "O") and click on the object to select it.

The settings in the tab "Mesh" are stored per each individual mesh and apply as soon as another mesh is selected.

[Add]

If you want to add one more mesh object, press [Add]. A pop-up dialog allows to define the amount of FFD control points and the size for the new mesh. For more information, go to the chapter ["File Menu"](#)<sup>790</sup>.

The new mesh will be added to the main window.

[Del]

In order to delete one of the existing objects, please select it first and then press [Del]. A pop-up dialog needs a further confirmation for this action, as it can not be undone.

### 10.2.1.4 [?]-BUTTON

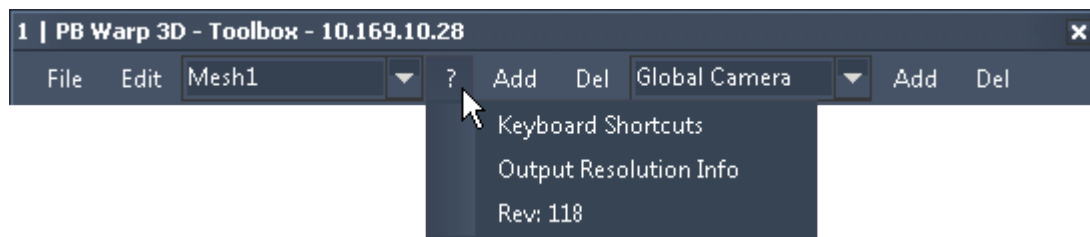

Here you find a listing of all keyboard shortcuts available in the application. Alternatively, you may open this window using [F1].

The "Output Resolution Info" informs you about the current resolution, reported from the graphic card. Before you start warping please make sure that the resolution is the correct one as all meshes and settings relate to the absolute resolution!

Lastly, the current revision is depicted.

### 10.2.1.5 CAMERA SELECTION

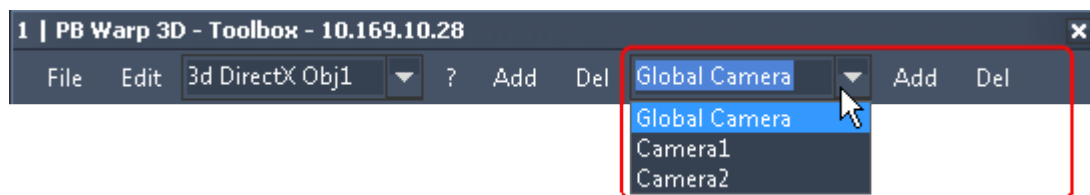

The Warper allows to deal with multiple cameras within one warping project. This is needed when using the Warper for a 3D application, meaning to import a 3D object from the screen you are projecting on

and to transfer the position from the real projector(s) to the virtual camera(s) rather than doing a [2D warping](#)<sup>780</sup>.

Choosing one of the existing cameras from the drop-down list will activate it and change the current view according to the stored settings from the chosen camera.

The settings in the tabs "[PB Camera](#)<sup>813</sup>" and "[Camera / View](#)<sup>813</sup>" are stored individually per camera.

[Add]

Per default a camera with the name "Global Camera" exists. If you want to add one more camera, press [Add].

Any changes done in the tabs "[PB Camera](#)<sup>813</sup>" and "[Camera / View](#)<sup>813</sup>" are automatically assigned and stored to the selected camera.

As you can create as many cameras as you like, you can create the ones that you need for a 3D set up in Pandoras Box and in addition some cameras that can be used to get an overview from your 3D scene. For example, next to the "Global Cam" you may create a "Front View", a "Side View" and a "Top View". The front view is applied with a camera position (X,Y,Z) = (0,0,-25), the side view could be (25,0,0) and the top view (0,25,0).

[Del]

In order to delete one of the existing cameras, please select it first and then press [Del]. A pop-up dialog needs a further confirmation for this action, as it can not be undone.

Please note that the "Global Camera" can not be deleted.

## 10.2.2 TOOLS BAR

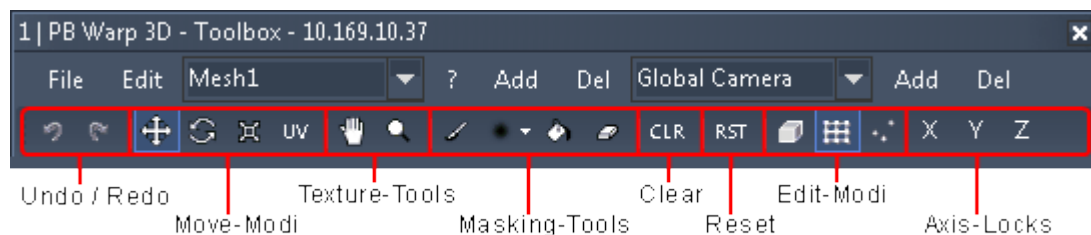

### Undo / Redo



Use this button to undo the last change done in the mesh, FFD or 3D object.

Please note: Undo only refers to moving tools. Changes done in the tabs themselves can't be undone. To enable the Undo/Redo function for the ScreenMask, please go to the tab and tick the check box



Use this button to redo the last undone change.

### Move-Modi

There are 3 possibilities to transform the selected mesh / FFD point(s) or entire object: you can either...



move



rotate or



scale the selection.

The fourth tool works for mesh points only! If you like to drag the entire texture, please use the tool "Drag Texture" as described below or the settings in the [Mesh tab](#)<sup>807</sup>. The UV icon can only be seen in the advanced mode. To activate it, open the "Edit" menu and choose "Advanced Mode".



drags the [UV map](#)<sup>785</sup> within selected mesh points.

Before moving points, decide whether you like to work with mesh points, FFD points or an object by switching to the according [Edit mode](#)<sup>804</sup>. Then select some points:

- mouse: click on a single point to select it, hold down the [CTRL] key additionally to multi-select points or drag a selection box
- keyboard: click the Up/Down/Left/Right key to select a single point and hold down the [CTRL] key additionally to multi-select points

Now, there are 3 different ways of applying a transformation change:

- keyboard: you can move the selection by holding down the Shift key and press the Up/Down/Left/Right key

- dialog: make a right-click on the move/rotate/scale icon to open the "Relative ... Dialog". There you can enter a specific numeric value and apply the change. Please note, that this works in a relative way, not absolutely! You can either undo the changes done in the dialog by hitting the Undo icon or by applying the inverse value, e.g after scaling by 50%, you may scale by 200%.

- mouse: you can move, rotate or scale the selection by holding the right mouse button pressed and moving the mouse up, down, left and right. You can switch from one transformation mode to another by clicking the respective button or by using the keyboard shortcuts. Press the following numeric characters on your main keyboard: [1] for moving, [2] for rotating and [3] for scaling. (When the Toolbox is active/selected, these shortcuts will not work. In that case, click into the Warper's main interface to unselect the Toolbox). If you like to transform along a certain axis, you may lock it with the according buttons X, Y, Z.

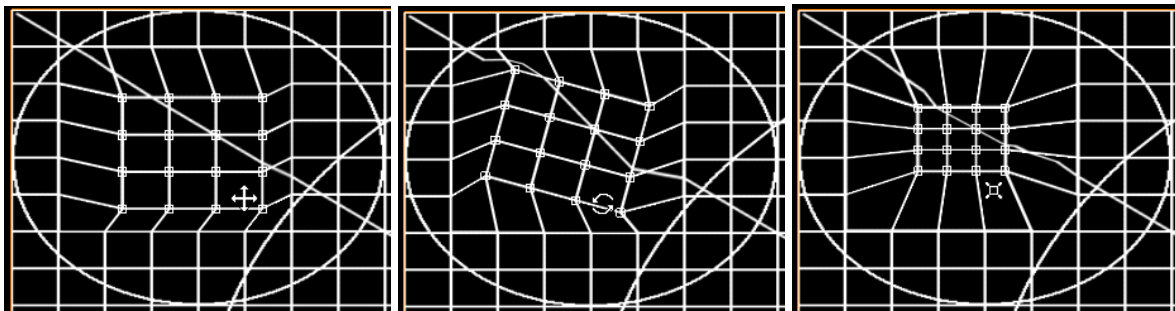

See here examples for a) Move Mode, b) Rotate Mode and c) Scale Mode.

## Texture-Tools



Drags the [UV map](#)<sup>785</sup> from the entire object. Please activate the [Textured mode](#)<sup>808</sup> and then use this function to drag the visible texture on the mesh. In the [Mesh tab](#)<sup>807</sup> you may adjust the UV map more precisely.



Zooms the [UV map](#)<sup>785</sup> from the entire object. Use this function to zoom the visible texture on the mesh. Moving mouse up zooms in, moving mouse down zooms out. Again, the [Mesh tab](#)<sup>807</sup> provides a more precise adjustment.

## Masking-Tools

Please change to the [Mask tab](#)<sup>810</sup> before using the following tools. This will show you a white texture instead of the texture chosen before.

The chapter covering the [ScreenMask](#)<sup>810</sup> explains as well how to work with the mask in more detail.



Draws on the mask on your warping object which later will hide parts of the real texture.



Unfold the drop-down list to see all available brush types for the painting tool.



Fills the whole texture black, which means that the mask covers everything from the texture and

nothing is visible. Alternatively you may use the button [Black Mask] in the [ScreenMask tab](#)<sup>810</sup>.

 Erases the black parts and thus makes the texture visible again.

### Clear



 After you have selected mesh or FFD control points, you can press this button to unselect the points again, that is to clear the selection.

### Reset

 Resets the position of selected mesh points. They will lose their offset (set up in the mesh mode) and go back to their origin position related to the FFD.  
Please note: Changes applied to the FFD control points and the screen mask will not be reset!

### Edit-Modi

Use these buttons (or the according shortcuts) to change between editing the object, the FFD or the Mesh. (When the Toolbox is active/selected, these shortcuts will not work. In that case, click into the Warper's main interface to unselect the Toolbox)

-  Objects can be selected and edited. (Keyboard Shortcut [O])
-  FFD control points can be selected and edited (Keyboard Shortcut [F])
-  Mesh control points can be selected and edited (Keyboard Shortcut [E])

### Axis-Locks

 Use these three buttons to lock or unlock the according axis. With a locked axis (highlighted button) any transformation like movement, scaling or rotation can solely be performed on this axis. The drawing tools are effected as well.  
As an example, let's say you are in the standard camera view, have selected some FFD control points and move them with mouse. Moving the mouse horizontally makes the FFD points move along the X-axis whilst moving the mouse vertically makes them move along the Y-axis. With a locked X axis, the points can not move along the Y-axis howsoever the mouse is moved.

## 10.2.3 TABS

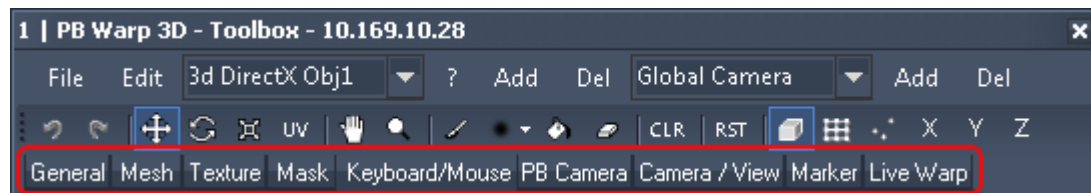

The Menu Bar is divided into the following tabs: [General](#)<sup>805</sup>, [Mesh](#)<sup>807</sup>, [Texture](#)<sup>808</sup>, [Mask](#)<sup>810</sup>, [Keyboard/Mouse](#)<sup>812</sup>, [PB Camera](#)<sup>813</sup>, [Camera/View](#)<sup>813</sup>, [Marker](#)<sup>815</sup>, [Live Warp](#)<sup>819</sup>

### 10.2.3.1 GENERAL

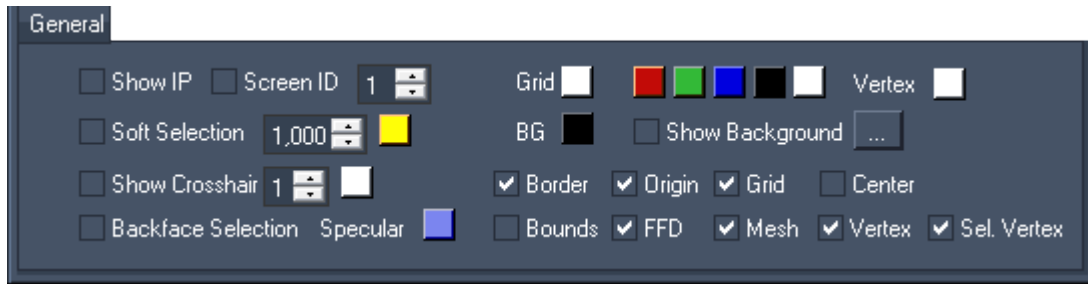

The "General" tab includes options that influence the appearance of the Warper interface. You may activate, deactivate or color certain visual objects. Some options are hidden in the basic mode and are only shown in the advanced mode. To activate it, open the "Edit" menu and choose "Advanced Mode".

#### Show IP and Screen ID

The "Show IP" check box displays the computer's IP address at the bottom left corner of the screen. This is helpful when working with several instances of the Warper.

The "Screen ID" check box displays the Screen ID in the center of the screen. Choose an ID number from the list on the right.

#### Soft Selection

Selects also neighboring mesh points within a particular radius. In the example depicted below, only one mesh point is originally selected (a), the surrounding ones are soft selected automatically (b). When the selection is moved (i.e. dragged using the mouse), the middle point is affected with the biggest possible offset. The further a point is away from the center, the smaller its offset gets (c and d). This is useful when you like to correct areas within your mesh without the result of having clear edges because the mesh points were not moved equally.

Set the radius with the numeric box. The default value for the radius is 1 [generic unit](#)<sup>783</sup>. As a soft selection is affected differently than a normal multi-selection (where all points would move with the same offset), a soft selection is represented with another color. Per default it is yellow. If you like to change it, click in the color field and choose your color in the newly opened color dialog.

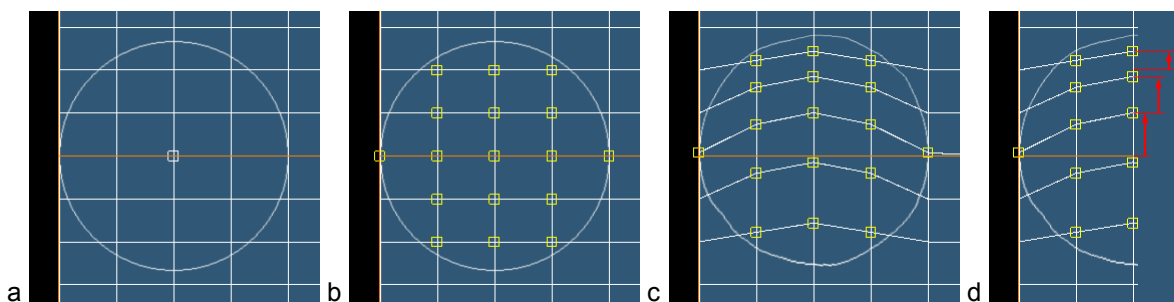

#### Show Crosshair

If this option is active, the position of the mouse cursor is clarified by showing a screen spanned horizontal and vertical line. You may set up how many pixels thick these two lines are and what color they have.

#### Backface Selection

When working with a three-dimensional object there might be [vertices](#)<sup>784</sup> that can not be seen from the current view point as another part of the object lies in front of them. The default setting - an inactive backface selection - lets you only select those vertices that are visible in the current view. An activated backface selection will select all vertices within your selection rectangle (drawn with the mouse). This option might need more time depending on the number of vertices and the size of the rectangle.

### Specular, Grid, Vertex and Background color

Click into the specular color field to assign another color for the global light source. The specular light reflection enhances the three-dimensional look when the [textured mode](#)<sup>808</sup> is active.

Grid       With these color fields you may change the color of the mesh lines. It is useful to work with different grid colors if you have an overlap between two warping grids. Once the lines match exactly, the color of the doubled grid lines change. This lets you work more precisely. Click into the leftmost color field to open a dialog that lets you pick a color of your choice. The five color field to the right apply the depicted color directly.

Click into the vertex color field to choose a different color for vertices / mesh points that are selected. Selected mesh points are indicated with a small rectangle.

Click into the BG color field to choose a different color for the background of the Warper interface. Activate the option "Show Background" and click the [...] button to display an image instead of a solid color.

### Check boxes

Check / uncheck the boxes to show / hide different visual auxiliaries.

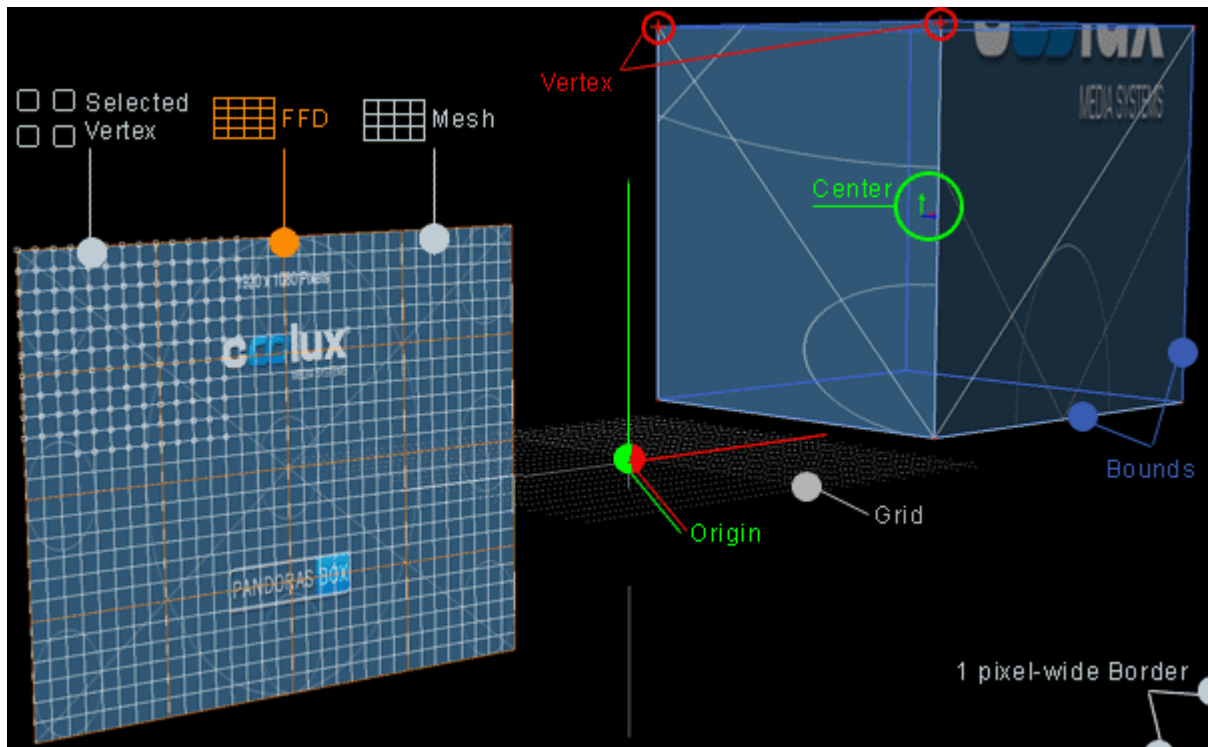

### 10.2.3.2 MESH

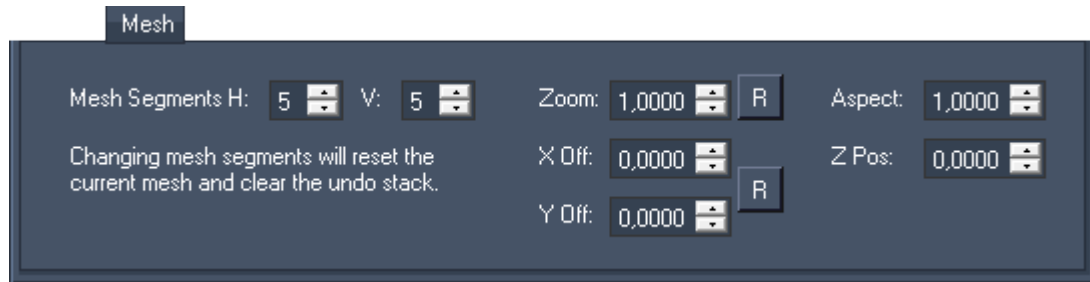

The "Mesh" tab allows to setup more mesh segments and to influence the UV texture map applied automatically to it. Please note that changes can only be applied to original meshes, not to imported objects.

#### Mesh Segments

Enter the amount of horizontal and vertical segments you want to use in your mesh. For more details, there is a [tutorial](#)<sup>[821]</sup> at the end of the Warper chapter.

Important:

Adjust the amount of mesh segments BEFORE you modify the mesh, because this will reset any changes you did to the mesh before! There is no CTRL-Z function. Nevertheless you may modify the mesh count as long as you are working with the FFD only.

#### UV Texture Mapping: Zoom, Offset and Aspect ratio

These settings influence the [UV texture map](#)<sup>[785]</sup> and can also be adjusted using the [Texture tools](#)<sup>[803]</sup> from the tools bar. Please activate the [Textured Mode](#)<sup>[808]</sup> first to see the changes done here.

##### ZOOM and ASPECT

Use the zoom option (or the Texture Tool  from the [Tools Bar](#)<sup>[802]</sup>) to zoom into the selected texture. The zoom values range from 1 to 99. The texture is enlarged while retaining the aspect ratio given by the mesh size.

A change in the aspect ratio, influences the texture's height only. The aspect values range from 0 to 99999999.

Press  to reset the value for the zoom and the aspect ratio to the default value 1.

##### X and Y OFFSET

The X- and Y-Offset (or the Texture Tool  from the [Tools Bar](#)<sup>[802]</sup>) enable you to move the displayed texture in both X and Y position. The possible values range from -1 to 1, whereas 0.5 would mean for example that the texture is moved half the way to the right and upwards.

Press  to reset the X- and Y-Offset to the default value 0. Please note that the Z-Position will be set to default as well!

#### Z Position

The Z position does not influence the UV map but the position from the mesh / object. According to the [coordinate system](#)<sup>[782]</sup>, positive Z values move the object backwards whilst negative values move it forwards. To change the Z position is especially important when objects overlap each other.

As seen in the example below, overlapping meshes with same Z-Order values will result in Z position fighting when the objects (exported as one object) are used in Pandoras Box. As this issue also depends on the camera position, it can happen that you see a Z fighting problem only under certain circumstances and maybe not in the Warper itself but with in the exported file in another program.

To export positions that can be clearly assigned, you have to define an unambiguous Z-Order (for the overlapping meshes).



A new warping project with two meshes is created. The meshes overlap each other partially. The [Textured Mode](#)<sup>808</sup> is active and Mesh 1 is selected.



Now Mesh 2 is selected, and therefore overlaps Mesh 1.

As long as the Z-Order for none of the meshes is modified, the selected mesh will always be displayed in front of the not-selected one



The two meshes are exported using the command "Export All" and assigned to a layer in Pandoras Box. Both meshes share the same Z position, with the overlapping area Pandoras Box can not clearly decide which polygons from which mesh are in front of other ones. The result is that both meshes intersect.



To create a clear assignment, Mesh 2 is brought to the front of Mesh 1 by changing its Z position to a lower value,



Now, it is irrelevant which mesh is selected in the Warper. Always, Mesh 2 covers Mesh 1. Also, the export in Pandoras Box shows no Z fighting any more.

### 10.2.3.3 TEXTURE

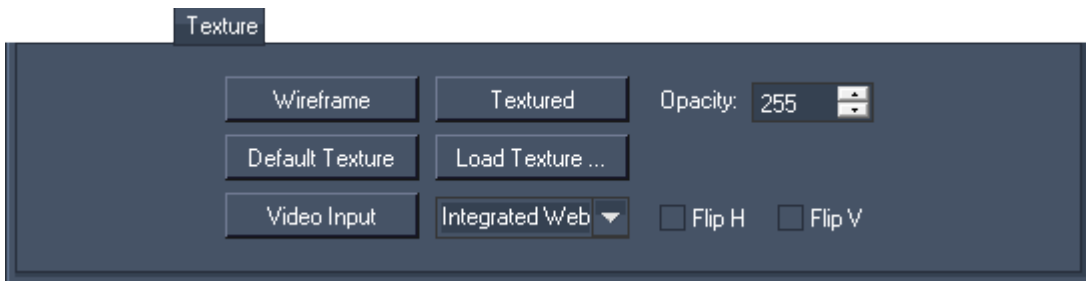

The "Texture" tab includes options that influence how meshes and objects appear in the Warper in terms of whether they are rendered with a texture or just in a wireframe mode. Some options are hidden in the basic mode and are only shown in the advanced mode. To activate it, open the "Edit" menu and choose "Advanced Mode".



## Wireframe versus Textured Mode

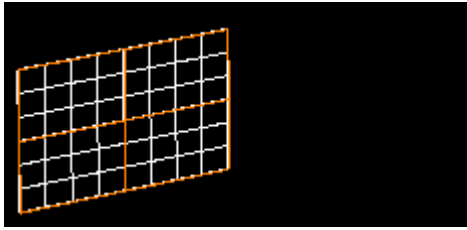

Click the "Wireframe" button to render meshes and 3D objects in a wireframe / grid mode only. Only the object that is currently selected is visible. Make sure that the check boxes "Mesh" and "FFD" are activated in the [General tab](#)<sup>805</sup>.

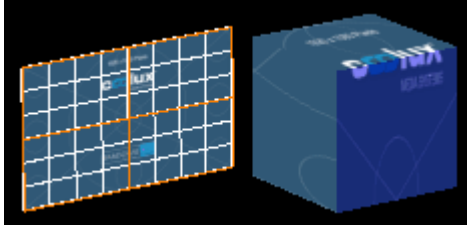

Click the "Texture" button to change to the additional Textured Mode. All objects are then rendered with a texture applied to them. The object that is currently selected is rendered with the wireframe on top.

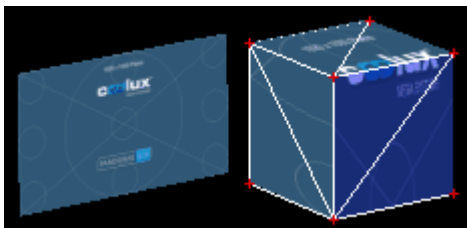

In the Textured Mode you will see the same texture on all objects. You may choose between the default texture, a coolux testpattern, a picture of your choice or a live input:

- Click the "Default Texture" button to return to the default view
- Click the "Load Texture" button to browse to a picture of your choice
- Click the "Video Input" button and choose an available input from the drop-down list. If needed you may flip the input horizontally or vertically

All textures can be rendered with a full opacity (value 255) or a lower one.

The Shortcut [G] toggles between the Wireframe/Grid and the Textured View.

## Toggle Face Visibility

This is another function that should be mentioned in this Texture Section.

With the keyboard shortcut [D] you are able to toggle the visibility of selected faces. This could be handy if there are parts in the projection where you do not want to have anything textured, e.g. when there is the need to cut out doors on a stage design.

As you just toggle hard edged faces, this is more a rough masking function. To create a finer mask for your screen, please refer to [Mask tab](#)<sup>810</sup>.

Please have a texture loaded to your mesh. To turn a face (the area surrounded by four mesh lines) to be invisible, select the mesh point that is down left of the face and press [D]. Turn several faces to be invisible when selecting more mesh points.

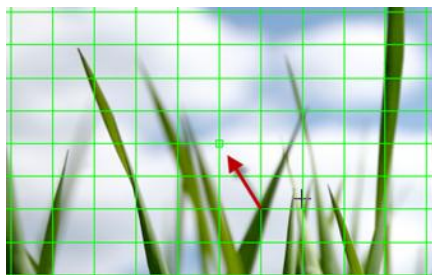

One mesh point is selected (red arrow is pointing at it).

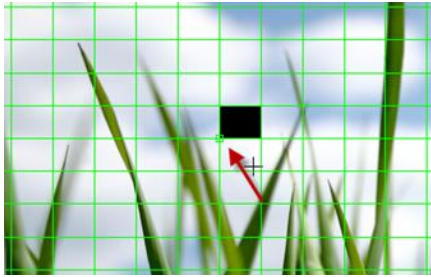

After pressing the shortcut [D] the face top right of the selected mesh point turns invisible.

To reload the texture later on, select the same points and press [D] again. To reload all hidden faces without selecting the according mesh points, use 'Activate all Vertices' from the [Edit Menu](#)<sup>794</sup>.

### 10.2.3.4 MASK

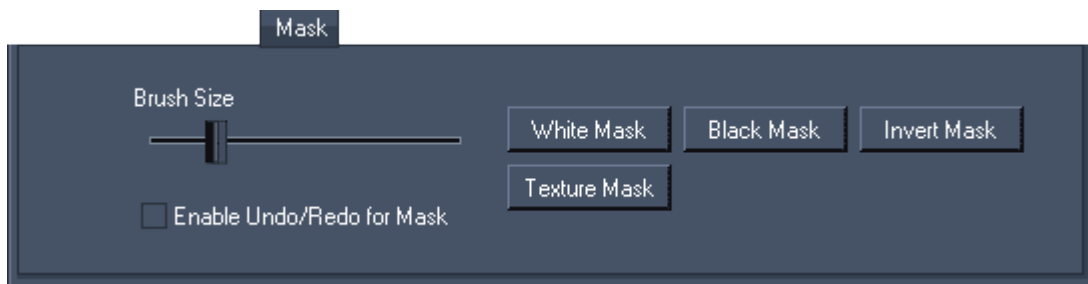

The ScreenMasking Tool allows you to mask while painting onto the projected surface from within the Warper. After finishing the mask, export it as \*.png file and use it on a high layer in Pandoras Box. This way the mask will perfectly match your warped surface. It is as well possible to open the \*.png file with other graphical programs.



When changing to the ScreenMask tab, the grid disappears and you see a white plane instead. Everything what is white will turn transparent in the exported \*.png file, i.e. it will not be visible and thus not hide underlying layers.

Now, select the Paint Mask Tool  from the [Tools Bar](#)<sup>802</sup> and draw onto the background by holding the left mouse button clicked. Everything what is painted will be black, also in the exported \*.png file. Thus it will cover underlying pixels when being exported to Pandoras Box.

The [axis locks](#)<sup>804</sup> can be useful when wanting to draw a straight line.

If you want to remove parts of your paintings again, select the Erase Tool  from the Tools Bar and move your mouse with the left mouse button clicked.

Please note that due to the fact that each object within the project is applied with the same texture, all objects will as well show the same mask. If you would like to create individual masks for each mesh or 3D object, please save the project after finishing the first mask and apply a new mask to all objects to start with the second mask.

Per default the [undo function](#)<sup>802</sup> does not cover the changes done in the mask as this consumes much memory space. However, if you like to use the undo option, tick the check box "Enable Undo/Redo for Mask".

### Brush type and size

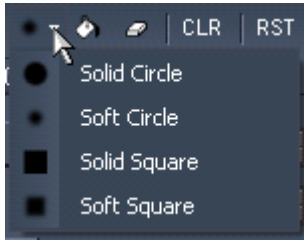



Choose a brush from the drop-down list in the Tools Bar.



Define the Brush Size by moving the slider left and right in the Mask tab.

### Mask Buttons

Click the "White Mask" button to get a plain white mask (all parts are transparent). Paint the parts that should be masked with the Painting Tool .

Click the "Black Mask" button to get a plain black mask (all parts will be masked). Erase the parts that should NOT be masked with the Erase Tool .

Click the "Texture Mask" button to use the normal texture as a mask background. You can set the texture in the [Texture tab](#)<sup>808</sup>. According to the brightness of the texture's pixels, the exported mask will be transparent, partly transparent or nontransparent.

Click the "Invert Mask" button to invert the mask. An example could be the right image (b) as an inverted mask from the left one (a).

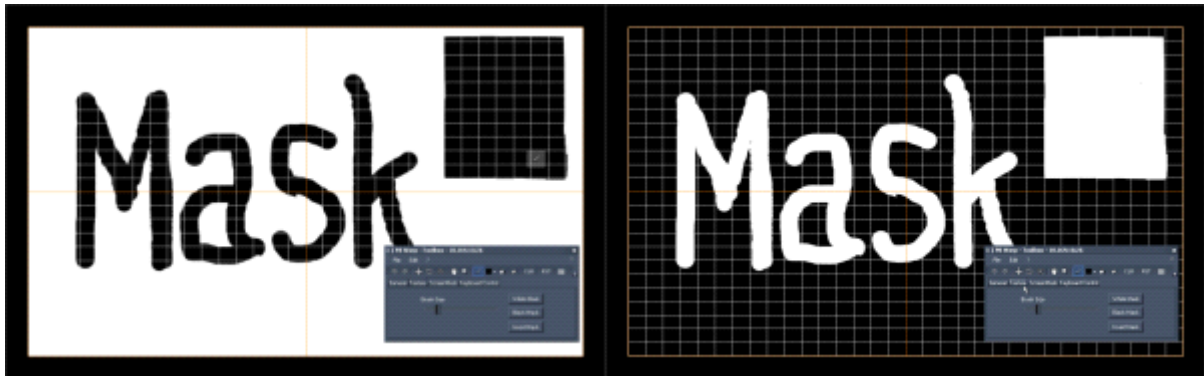

a) Black parts painted on white background

b) White parts erased from a black background

### Using the mask in Pandoras Box

First of all the mask needs to be exported. Click on File > Save mask, browse to the location where you want to store your mask-file and name it. A \*.png file will be created.

Use the mask on a layer in Pandoras Box that lies in front of other layers. It is a good practice to use the very last layer (before the Camera layers) and to rename this layer.



a) The mask from the example above is used in Pandoras Box on top of the content layer.

b) The inverted mask from the example above is used in Pandoras Box on top of the content layer.

The great benefit of this masking tool is the live painting on the projected surface, because this mask will exactly fit to your warping file.

### 10.2.3.5 KEYBOARD/MOUSE

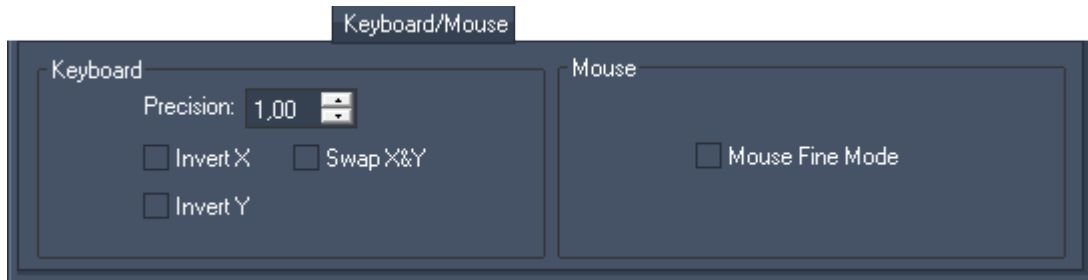

#### Keyboard

Use the keyboard control settings to adjust the keyboard behavior for editing the mesh.

##### PRECISION

The precision value ranges from 0,01 to 99, whereas the default value is 1 which means that one keystroke results in a movement of 1 pixel. When doing a rough Grid / FFD adjustment start with less precision (> 1) to save time. Later on the fine adjustment can be done with a higher precision (< 1) if needed.

##### INVERT X AND Y

When warping a rear projection and / or the picture is upside down, inverting X and / or Y movement can help you adjusting the mesh with the keyboard.

#### Mouse

Use the mouse control settings to adjust the mouse behaviour for positioning the camera.

Tick the check box "Mouse Fine Mode" if you like to shift the camera position with more precision. You will see the result in the [Camera / View tab](#)<sup>813</sup>.

### 10.2.3.6 PB CAMERA

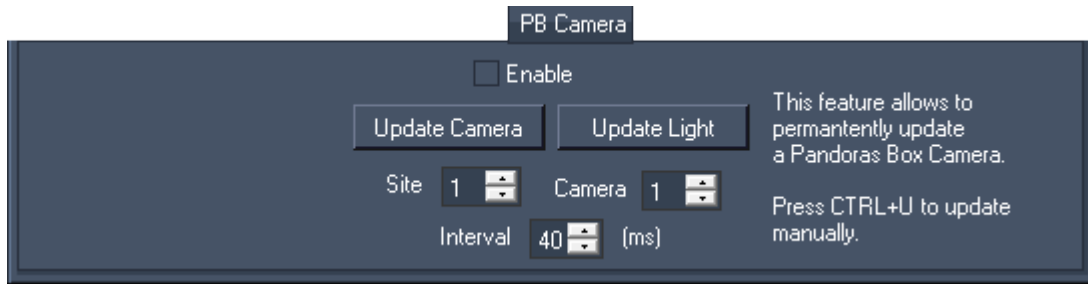

The tab is hidden in the basic mode. To activate the advanced mode, open the "Edit" menu and choose "Advanced Mode". This is only available in the Warper 3D edition.

The "PB Camera" tab enables you to transfer values from a camera set up in the Warper to a [camera](#)<sup>589</sup>, [output](#)<sup>597</sup> or [light layer](#)<sup>582</sup> in Pandoras Box.

First of all, choose the camera from the Warper from which you would like to transfer data. Once you have picked a [camera via the drop-down list](#)<sup>801</sup> at the top right of the Toolbox, make sure that the settings in the [tab "Camera / View"](#)<sup>813</sup> are correct. Now set up the connection to a Pandoras Box master system (PB) via [Edit > Network Settings](#)<sup>800</sup>.

Click the "Enable" check box to send values permanently from the [Camera / View tab](#)<sup>813</sup> to the Output or Camera layer in PB. The site and layer ID can be set up with the numeric boxes. The interval can be adjusted with the numeric box at the bottom.

If you do not want to update the layer permanently you may click the button "Update Camera" instead. This will transfer the current values only once. As an alternative, you may press Ctrl+U. If you like to transfer the values to a light layer, click the button "Update Light".

### 10.2.3.7 CAMERA/VIEW

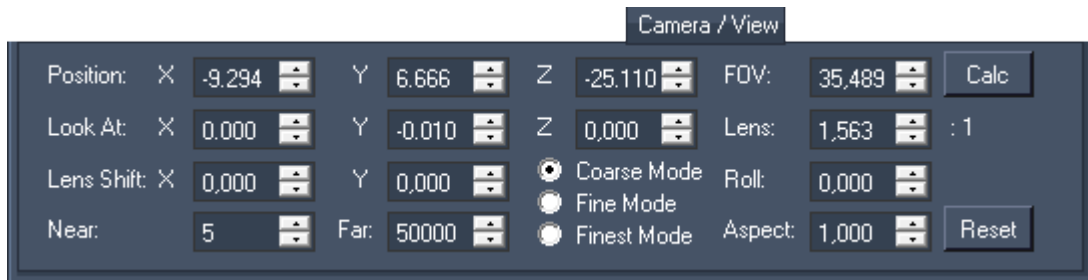

The "Camera / View" tab is hidden in the basic mode. To activate the advanced mode, open the "Edit" menu and choose "Advanced Mode". This is only available in the Warper 3D edition.

The tab enables you to adjust the position, orientation and lens settings of a camera in the Warper. This is needed when you do 3D Warping as described in the [introductory chapter](#)<sup>780</sup>. A camera can be added and selected in the [camera selection field](#)<sup>801</sup> at the top right of the Toolbox. Choosing a different camera will change the currently seen settings in this tab.

Please read the last chapter to learn [how to transfer these settings to a camera in a Pandoras Box](#)<sup>813</sup> master system. The next chapter covers a [marker based camera calibration](#)<sup>815</sup>.

#### Meaning of parameters and how to measure them for 3D Warping

Position	The six parameters for the X, Y, Z Position from the camera and its "Look At" target plus the roll parameter define where the camera is positioned, where it is looking and how it is orientated.
Look At	
Roll	

	<p>As said in the introductory chapter where 3D Warping is compared with 2D Warping, you need to adjust the camera's and the object's position and orientation as well as the lens setting. Regarding the position and orientation, there are two possible ways to do so: manual measurement or <a href="#">marker-based calibration</a><sup>815</sup>.</p> <p>To measure distances and sizes manually, you should first define where the zero point of the coordinate system is; to simplify the process you can define that it lies on a certain corner of the object or projector. Based on that zero point, you need the relative X,Y and Z distances to the screen (exactly where the object's <a href="#">pivot point</a><sup>784</sup> lies) and projector lens (center of the lens). Then you need the size of the real object to convert the measured "number" into the unit that has been used for the size of the virtual object. If the virtual size is 2 GU, and the real size is 200cm, the conversion factor is 1 GU / 100 cm. Thus, you know, that a distance of 150cm is 1.5 GU (distance * conversion factor).</p> <p>Now you can calculate the XYZ position of the camera and the object (corresponding with the Look At Target) as well as their orientation. The orientation from the object results from its XYZ angle. The orientation of the camera is the result of the difference between the position and the Look At target plus the Roll parameter</p>
<p>FOV Lens</p>	<p>The parameters FOV and Lens express the same setting: the opening angle. When you enter the FOV, the Lens parameter is automatically calculated and vice versa.</p> <p>There are two ways to find out the opening angle: manual measurement or iteration. For manual measurement you need the width of the projected image plus the distance between the center points of the lens and the image (at the depth where the width was measured). These two numbers can be entered in the FOV calculator available with the Calc button. The measuring unit does not matter as long as it applies to both values. Click "Apply" to transfer the calculated value to the main tab.</p> <p>Alternatively you can simply try out and approximate what the lens factor is. If you have a lens with a fixed zoom, use this lens factor and try out whether a slightly higher or lower number gives better results. (Even fixed zoom lenses, can slightly change due to mechanical vibrations.) If the lens has a variable zoom, start with the smallest lens factor and increase it slowly. It is clearly visible in the projected image whether you are approaching the correct factor or not.</p>
<p>Aspect</p>	<p>The Aspect parameter expresses whether the cameras aspect mode is the same one as the output's aspect mode.</p>
<p>Near Plane Far Plane</p>	<p>Near and Far plane define what part of the cameras cone is rendered. If an object lies outside of the range, it is not seen and rendered by the camera. In 99.9% of all cases the default values give good results and should be not be changed.</p>

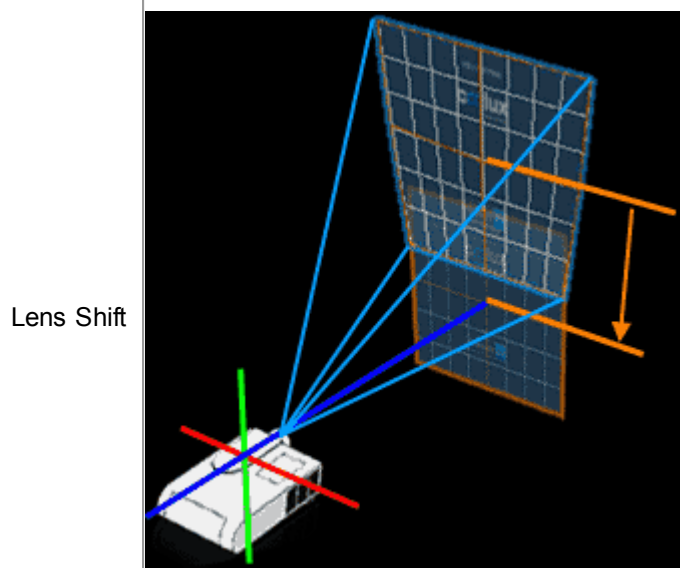

The Lens Shift parameters define how much a projector is lens shifted. For [3D Warping](#)<sup>780</sup> (either measuring or marker-based) it is strongly recommended to reset the projector(s) lens shift to 0,0. However, some projectors have a build in lens shift that cannot be adjusted. You can see that easily by looking onto the lens if the projected image is in the center of the lens. If it is outside of the center, there is an active lens shift. Or, you can see it from the side: check whether the lens' center matches the center of the projected image. In the left image, one can clearly see that the projected blue outlines image is above the projector itself. If the projector had no lens shift applied, the image would look like the one with the orange outline.

In the case that the lens shift cannot be adjusted in the projector, use the lens shift parameters in the Warper. In practice you can measure the lens' center to the floor and mark it on your screen depending on the projectors angle, or you can use a laser. At the end you should be able to know where the unshifted image center should be.

Then adjust the lens shift so that the center of a default mesh is at the same height and width as the marked lens center. That could mean of course that parts of the mesh are outside of the projected image. This will be corrected after adjusting the position and orientation of the camera.

The Reset button resets all parameters. Please note, that there is no undo function!

### Moving a camera using the mouse

- Zoom: Scrolling with the mouse wheel influences the camera's Z position
- Rotation: Moving the mouse whilst holding the Alt key and the middle mouse button influences the camera's X and Y position. As all other parameters are not influenced this has an effect as if the camera rotates around a fixed point.
- Pan: Moving the mouse whilst holding the middle mouse button influences the camera's X and Y position and the "Look At" position at the same time.

For a finer adjustment, activate the option "Mouse Fine Mode" in the [Keyboard / Mouse tab](#)<sup>812</sup>.

### Adjusting a camera using the numeric boxes

At the same time you may set up these and other settings, e.g. lens settings, with the numeric boxes in the tab. You may enter a number directly or increase / decrease it. For this you can either use the up / down buttons next to each field, or click once into the numeric box and scroll using the mouse. The in-, decreasing adjustment can be made more or less precise with the radio buttons: Coarse Mode, Fine Mode and Finest Mode.

#### 10.2.3.8 MARKER

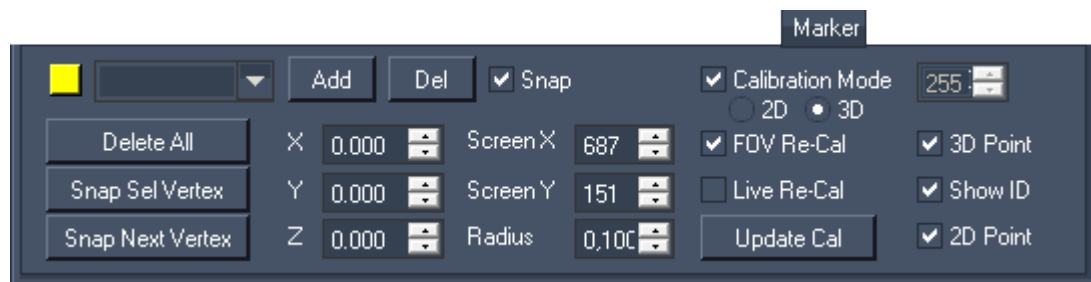

The "Marker" tab is hidden in the basic mode. To activate the advanced mode, open the "Edit" menu and choose "Advanced Mode". This is only available in the Warper 3D edition.

The tab enables you to add and position so called markers. As well view settings concerning the marker representation can be found here. There are more commands under [Edit > Marker](#)<sup>798</sup>.

Please read the previous chapters to learn what the [Warper camera's parameters](#)<sup>813</sup> are and [how to transfer them to a camera in Pandoras Box](#)<sup>813</sup>.

### General meaning of markers

Markers enable an automatic calibration of a camera's position and orientation (but not its lens settings!). A minimum of 4 markers is needed to adjust a camera in a 3D environment. The marker-based calibration is an alternative to manual measurement (of the projector's and screen's XYZ position)

and data transfer to the parameters in the Camera tab. Both ways are attempts for a virtual 3D representation of the real 3D setup. Please keep in mind that this is not always necessary. Especially when working with only one camera or without 3D objects you can realize warping as well by straightening the projected image with a 2D mesh. This workflow is described in more detail in the [introductory chapter](#)<sup>780</sup>.

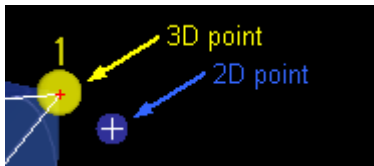

The calibration is based on the position of the markers. When creating one marker, a 3D point plus a 2D point are added to the project. At first, the two points share the same position but when you change the view by modifying the position/orientation of the camera you will see that there is a difference. The 3D point - per default a yellow circle with an ID - is "glued" to the object, thus it changes the position on the screen.

The 2D point - a smaller blue circle with a white cross inside - has no reference to the object but stays on the same position of the screen as if painted on it. This explains the name "2D" it has no Z Position. In short: Whilst the 3D point has its place on the virtual object, the 2D point needs to be placed on the same spot but looking at the projected image, i.e. the real model. After positioning the markers (placing the 3D and 2D points) the calibration finds the best camera position where both points share the same position again.

### How to warp with markers

Before you start warping, you might want to setup an additional screen to have an better view of the Warper interface (as the projected interface is obviously distorted). You could either connect a second display and set the display driver to clone/duplicate the screen. Or you could connect another computer via VNC to the computer that is connected to the projector and that runs the Warper.

Import the 3D model from the screen / object you are projecting on. It must match the real screen / object as accurately as possible. However, if changes were applied to the real object after the virtual model has been created or if it simply does not fit, you can adjust the model by moving its [vertices](#)<sup>784</sup>. If you are projecting on a two-dimensional screen you can create the object in form of a mesh in the Warper directly. Choose File > New and set a size according to the real screen's dimensions.

Open the "Edit" menu and activate the "Advanced Mode". Adjust the object size if needed (as described in the [Tools Bar](#)<sup>802</sup>) and the view in the Warper (as described in the [previous chapter](#)<sup>813</sup>) so that the interface looks very roughly like your view onto the object.

Now you can start adding markers. A minimum of 4 non-planar markers is needed when working with a 3D object. "Non-planar" means that one point must not lie on the plane that is defined through the other 3 points. When working with a 2D object, on the other hand, a minimum a 4 co-planar markers is needed. "Co-planar" means that all 4 points must share the same plane. In general the best results are achieved when placing the markers "far away" from each other.

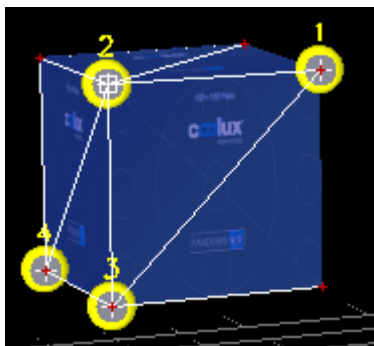

1. step: adding markers

According to your view onto the object, decide where you want to place the 4 markers. You can do this in two ways.

- a) Click on the "Add" button. The mouse cursor becomes a thick plus (+) icon when the mouse is within an object. Click onto a vertex to add the marker there. If you have many vertices and the marker did not snap to the right one, you can select the right vertex and click the button "Snap Sel Vertex"
- b) Select a vertex by clicking on it directly or by selecting it through a selection rectangle. Now, choose "Edit > Marker > Add to selected vertex" to add the marker there.

You may modify the view, rotate or zoom, at any time. This is useful when working with an object with many vertices, as it can be tricky to pick a certain one. If you are done with the fourth marker, adjust the view so that you can see all markers again; if you like to relocate all 2D



Points to the position of the 3D points, choose "Edit > Markers > Reset all 2D Points"

Now we have placed the markers, or rather the yellow 3D points of them. The next step is to position the blue 2D points.

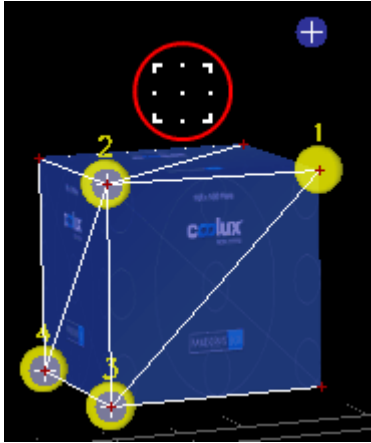

In order to get access to the 2D points, tick the check box "Calibration Mode". The view varies: the grid and 3D points are dimmed and the mouse cursor changes to a cube-like cursor as highlighted in the left image. If the texture distracts you, you can dim it with the number field to the right or toggle it off with "Edit > Marker > Show Calibration Overlay".

Underneath the check box there are two radio buttons "2D" and "3D".  
 - Pick "2D" if working with a two-dimensional object and having placed the four markers in a co-planar way.  
 - Pick "3D" if working with a three-dimensional object and having placed the four markers in a non-planar way, as seen in the example.

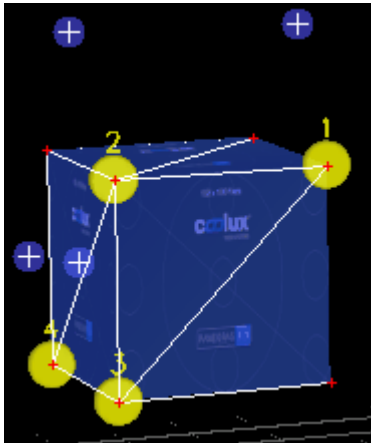

2. step: dragging the 2D points

Again there are two ways how you can influence the position of the 2D points. Please note that the camera view should not be altered from now on.

a) Use the mouse, especially for the first rough setup. Click with the cube-cursor onto the first marker (i.e. the yellow 3D point) to select it. The blue 2D point jumps onto the cursor and can now be dragged. Move the mouse until you see on your real screen that the 2D point is at the same spot as the 3D point is on the virtual model.

b) Use the number fields "Screen X" and "Screen Y", especially for fine-tuning. You may select another marker by changing the drop-down list

If you have difficulties locating the cursor (and the attached 2D point) it could be helpful to activate the "Show Crosshair" option in the [General tab](#)<sup>805</sup>. At the end all four 2D points are moved to the according spot from the real screen object. In other words, the 2D points have formed a specification for the camera position that needs to be found in the next step.

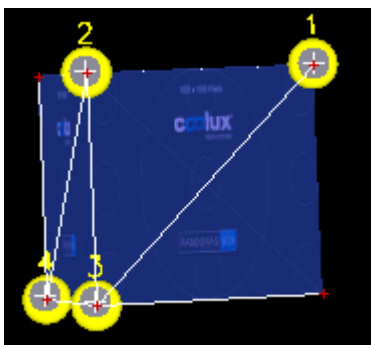

3. step: the Warper calculates a new camera position

According to the new position of the 2D points the camera can now be calculated. Click the button "Update Cal".

Now an algorithm runs over and over and returns the best possible position for the camera. From this position the camera sees the object just like the real projector "sees" the real screen. As a result the virtual object with its "glued" yellow 3D points is depicted in the camera view in such a way that the blue 2D points share the same position again.

If the result does not meet your expectations, please check the following options.

- Are the lens settings set up in the correct way?

Please select the [Camera/ View tab](#)<sup>813</sup>. If you have a projector with a fixed lens shift or if you cannot shift it to 0,0 for any reasons, enter the lens shift (X and Y) in the according fields and run the calibration again by clicking "Update Cal". The algorithm now considers this offset in the calibration.

Please check as well whether the FOV accords with the lens factor of the projector lens. How to measure it is explained in the section "FOV / Lens". You do not necessarily need to click the "Update

Cal" button. With an active Calibration Mode, you can tick the check box "FOV Re-Cal" and now, the calculation is done each time when a new FOV is entered. This way you can find the correct settings in just a couple of seconds.

- Is the 3D model correct?

Obviously the calculation depends on the accuracy of the 3D model. If changes need to be done to the model you can select a vertex and move it to the correct position. You may transform a selection of multiple points as well.

- Are the 2D points positioned correctly?

Try to find a better position for the 2D points (using the mouse or the number fields as described above). You do not necessarily need to click the "Update Cal" button each time. With an active Calibration Mode, you can tick the check box "Live Re-Cal" and now, the calculation is done each time when a new position is entered. This way you can find the correct position in a very short time. Due to the cushion effect from the lens it's quite possible that the 2D points must be placed slightly outside the object.

- Have you tried adding more markers?

As said above the minimum marker number is 4. Adding more markers can give better results. When working with a 3D model, place additional markers outside of planes defined by three other markers as then a plane is overdetermined.

- Does the projector lens have a strong cushion effect?

If the projector distorts the lines due to a strong cushion effect you may apply a mesh to the output layer that evens it out. A good way to generate the needed mesh is to first apply all settings to the PB camera that were found with the current project. Then you may open a new project with a default mesh and use the [Live Warping](#)<sup>819</sup> feature.

- Have you tried other options for the algorithm?

Under "[Edit > Marker > Calibration Settings](#)"<sup>798</sup> there are options that adjust the algorithm.

### Meaning of parameters, options and buttons

yellow color field	click into the field to open a dialog where you can pick another color for the 3D points and their ID
drop-down menu	allows to select another marker to adjust the according position of the 3D (parameters X Y Z) and 2D point (parameters Screen X and Y) as well as the 3D point's color and size (parameter radius)
button Add	turns the mouse cursor to a thick plus (+) icon and generates a marker when clicked
button Del	deletes the marker chosen in the drop-down menu; this command cannot be undone!
check box Snap	when a marker is added to the object with an activated Snap function, it will snap to the nearest vertex
button Delete All	deletes all markers; this command cannot be undone!
button Snap Sel Vertex	snaps the selected marker (via the drop-down menu) to the vertex that has been selected
button Snap Next Vertex	snaps the selected marker (via the drop-down menu) to the nearest vertex; if a marker is already located on a vertex it will not change its position
number fields X, Y, Z	position of the 3D point of a marker
number fields Screen X, Screen Y	position of the 2D point of a marker
number field Radius	size of the 3D point (in generic units)
check box Calibration Mode	activates the Calibration Mode (and its overlay), i.e. the mouse cursor changes to a cubic-like icon that allows to drag the blue 2D points; only with

	an activated Calibration Mode it is possible to activate the FOV Re-Cal and Live Re-Cal
radio buttons 2D / 3D	must be chosen before the calibration is started; - pick "2D" if working with a two-dimensional object and having placed the four markers in a co-planar way; - pick "3D" if working with a three-dimensional object and having placed the four markers in a non-planar way, as seen in the example above
check box FOV Re-Cal	enables to "interactively" change the FOV in the Camera / View tab; each time another value is entered, the calibration runs and returns the new camera position
check box Live Re-Cal	enables to "interactively" change the 2D points; each time a new value is entered and each time a 2D point is dragged, the calibration runs and returns the new camera position
button Update Cal	starts the calibration. An algorithm runs and estimates the best camera position depending on the position of the 2D points, as well as on the lens shift and FOV set up in the Camera / View tab
number field to the right	changes the opacity of the overlay shown when the Calibration Mode is active; the overlay can be toggled with "Edit > Marker > Show Calibration Overlay"
check box 3D Point	toggles the visibility of the yellow 3D point of a marker
check box Show ID	toggles the visibility of the identification number above a yellow 3D point of a marker
check box 2D Point	toggles the visibility of the blue 2D point of a marker

### 10.2.3.9 LIVE WARP

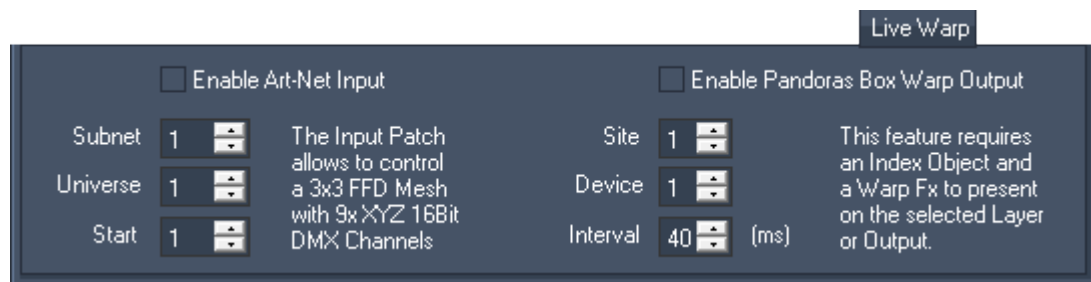

The "Live Warp" tab is hidden in the basic mode. To activate the advanced mode, open the "Edit" menu and choose "Advanced Mode". This is only available in the Warper 3D edition.

The tab enables you to setup a connection to another device in order to input and / or output data so that the Warper is controlled by another device and / or controls another device itself.

A guide that explains the Live Warping feature in more detail can be found [here](#)<sup>828</sup>.

#### Art-Net Input

The settings on the left side of the tab allow to activate the Art-Net input as well as to set the patch, i.e the Subnet, Universe and the starting number also known as the channel.

The general purpose of this feature is to be able to control a mesh from another device, may it be a lighting desk or Pandoras Box (outputting Art-Net). In detail, an FFD point can be moved along the X, Y and Z axis. Each of these 3 parameter has a resolution of 16bit. Hence, one FFD point listens to 6 Art-Net channels. In this manner, up to 9 FFD points can be remote controlled. An according device is available in Pandoras Box ( tab "Device Types" > "DMX Fixtures" > "COOLUX" > "PB Warp 3x3.clib").

The first channel is applied to the FFD point in the upper left corner, or more precisely to the X parameter of it. Please see the following table for more information about the internal patch.

Ch 1,2 X	Ch 3,4 Y	Ch 5,6 Z	Ch 7,8 X	Ch 9,10 Y	Ch 11,12 Z	Ch 13,14 X	Ch 15,16 Y	Ch 17,18 Z
1st FFD point			2nd FFD point			3rd FFD point		
Ch 19,20 X	Ch 21,22 Y	Ch 23,24 Z	Ch 25,26 X	Ch 27,28 Y	Ch 29,30 Z	Ch 31,32 X	Ch 33,34 Y	Ch 35,36 Z
4th FFD point			5th FFD point			6th FFD point		
Ch 37,38 X	Ch 39,40 Y	Ch 41,42 Z	Ch 43,44 X	Ch 45,46 Y	Ch 47,48 Z	Ch 49,50 X	Ch 51,52 Y	Ch 53,54 Z
7th FFD point			8th FFD point			9th FFD point		

Please note that due to the Art-Net protocol the IP address needs to be set to 2.x.x.x and the subnet mask to 255.0.0.0. The FFD count of the mesh must not exceed 3x3 points.

It is possible to input Art-Net at the same time as the warp output is activated.

### Warp Output

The settings on the right side of the tab allow to activate the Pandoras Box Warp Output and to set the according settings, that is the target Site ID, Device ID and interval (transmission rate).

This feature enables you to control an object on a Pandoras Box layer in real time from within the Warper or through another device. Or in other words, it makes it possible to warp live. This is of particular interest when projecting on a moving, deforming screen or when the projector is moving itself. Another application is described below.

In detail, the feature works like this that single or multiple mesh points can be moved in the Warper along the X, Y and Z axis (by hand or by an input device). According to the interval time, the changes done in the Warper are transmitted directly to an object that is part of a [graphic / video layer](#)<sup>298</sup> or [output](#)<sup>597</sup> in Pandoras Box. The object needs to be a so called "index object". An index object can be exported from any object or mesh from within the Warper. The command is available in the [File menu](#)<sup>789</sup>. Furthermore, a Warp FX is required on the layer. The effect actually receives the data and influences the index object accordingly. For more information and a step-by-step tutorial, please read the [Live Warping guide](#)<sup>819</sup>.

You can remote control Pandoras Box from one or more Warper applications. The Warper may run on the same computer or on another one connected via network. In the last case, please check the [network settings](#)<sup>800</sup> in the Edit menu and make sure that the used network switch is capable to transmit the data in the set time.

As said above the application for the Live Warp feature include the projection with a moving screen or projector. Another application would be in a scenario where an object, a 2D or 3D object, is already applied to a graphic or video layer and thus deforms the according media file; or in a scenario where a camera is moved to another position. Under certain circumstances it is needed to deform this result again. For example, if the projector's lens has a strong cushion effect. In that case, generate a mesh and export it as a index file. Apply it together with the Warp FX to the output layer. Now you can address this output layer in the tab "Live Warp" and whilst you are deforming the mesh in the Warper the output's object deforms as well and influenced all underlying graphic / video layers.

## 10.3 WARPING GUIDE

This chapter includes step-by-step tutorials about 2D warping. Whilst 2D warping is based on deforming the 2D content in a way that it looks correct again, 3D warping achieves this by placing (3D) objects and the camera in 3D space. For more information please read the [introductory chapter](#)<sup>780</sup>.

The first tutorial explains, how to [warp a 2D mesh](#)<sup>821</sup>. It shows how to decide for the best FFD and mesh count and how points can be moved.

Afterwards it is explained in detail how to [export the mesh and use it in Pandoras Box](#)<sup>824</sup>.

Then there is an tutorial showing how to work with [associated meshes](#)<sup>825</sup>.

The last one tells more about the [live warping feature](#)<sup>828</sup>.

### 10.3.1 GENERAL WARPING WORKFLOW

#### Setting up FFD control points and mesh segments

Before you start moving the control points you have to decide with how many FFD control points and mesh segments you should work. Please follow this link if you are not sure about the [difference between FFD and mesh](#)<sup>786</sup>. The FFD count is set up via the [File](#)<sup>789</sup> menu and the mesh count in the [Mesh tab](#)<sup>807</sup>. The perfect amount depends on your screen surface and outline.

The more warping projects you have done, the faster you will be able to tell the best FFD and mesh count. If you are not sure in the beginning, simply make a guess and start warping. You will see quite fast, that you have picked too many or too less FFDs. Too many FFD points are not that bad, it might take more time during the FFD-phase but you could save time during the mesh-phase - at least if not way too many FFDs were picked. If you have picked too less FFD points you will notice that you will have to move mesh points at a very early stage of warping. This will definitely be more time-consuming than starting all over with a new mesh. In addition, it is easier to obtain a good quality mesh (as described below) with FFDs instead of offsetting single mesh points too far. If you like, you can save the current project and have a quick look whether a new mesh with more FFDs does give you better results and eases your work. This can be found out in a few seconds but save minutes or even hours.

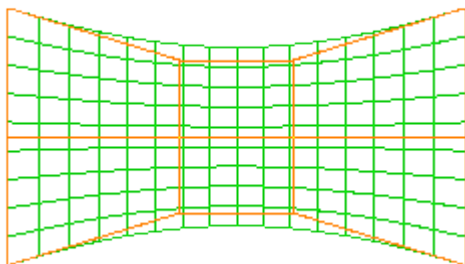

Example 1, a 4x3 FFD

A simply bend screen will go well with only 3 vertical FFD control points. Horizontally there needs to be done more warping, thus 4 FFDs work better. The more smooth the outline has to be, the more horizontal mesh segments you should take. In this case there are 20 mesh segments.

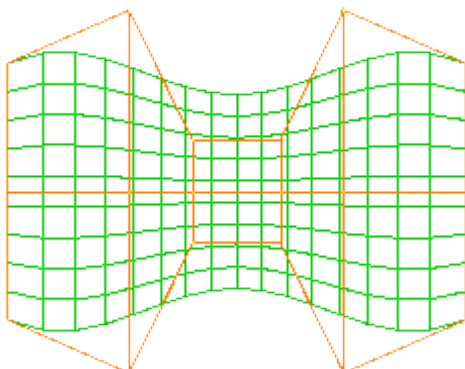

Example 2, a 6x3 FFD

Curved screens that are more complex will be easier to handle if you increase the amount of FFD control points. In this case there are 6 horizontal control points and still 3 vertical ones.

The curved outline of the mesh is the result by only moving the FFD control points.

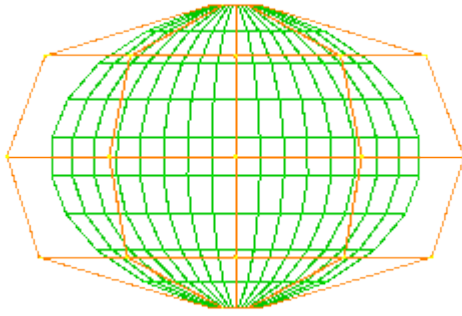

Example 3, a 5x5 FFD

Spherical screens are bend in all directions. They require to increase the amount of vertical FFD points as well. In the depicted example a mesh with an 5x5 FFD is shown. If the projector looks straight on the equator, the mesh deformation will be quite homogenous and the FFD should look similar to the example.

The amount of mesh segments can be altered as long as working only with the FFD control points. As soon as a mesh point is moved, the amount should not be changed any more.

In general, the amount of mesh segments depends on how exact the warp needs to be. Firstly this is a question how complex or detailed the screen is, including the outline, as shown in the above example with the simply bend screen. If the screen is quite flat itself but has a very detailed outline, it could be a faster solution to [create a mask](#)<sup>810</sup> instead of increasing the mesh count.

Secondly, it is important whether you are projecting with single projectors only, or if several projectors overlap each other. Within the softedge area the pixels from both projectors must overlay each other perfectly. This requires a higher mesh count. As a rule of thumb, at least 7 mesh segments should lie within the overlap area.

By the way, it could be helpful to work with mesh segments that have the same height as width. If your projector has an aspect ratio of 16:9, you could set up a mesh count of 16 by 9 during the FFD-phase and increase it to 32 by 18 or even 48 by 27 before starting the mesh-phase.

## Deforming the FFD and mesh

A good quality mesh refers to a mesh where the mesh lines are uniformly distributed on the screen. For example, if the screen is 2m wide, and there are 20 horizontal mesh segments, each segment should be 10cm wide. If this is not achieved sufficiently, and you project text that moves across the screen, it would scroll unevenly. Wherever there are smaller distances between mesh lines, the text would be smaller too. Wherever there are larger meshes, the text is enlarged.

If your content does not contain critical movements or visible geometrical forms, you can warp a little more rough. So before you start warping, or before you spend too much time within the last phase, check the content and decide how perfect the result really needs to be.

For some people it is quite hard to perceive equal distances. To fasten and ease the warping workflow, try to mark certain points on the screen. If you mark for example every 40cm with tape, it will be much easier to arrange the mesh equally. If you cannot tape on the screen, a rotatory laser can be helpful as well.

For the same reason it can be worth the time to create special test patterns. This is definitely recommended when projecting on complex geometries and the later on used content refers to the geometry.

Keeping this mind we can now start warping. The golden rule is always to warp as much as possible with the FFD, but not more than necessary. Or in other words: the **FFD is for the coarse adjustment and the mesh for fine-tuning**.







Whilst moving the FFD points, match the mesh outline (= content outline) as good as possible with your screen outline. At the same time keep an eye on the distance between the horizontal lines and between the vertical lines. As soon as you recognize that moving an FFD point helps within a small mesh area but "destroys" an higher number of other mesh areas it is better to finish with the FFD-phase. Decide for a final mesh count and move on to moving meshes. Here you will see that the better the FFD was adjusted, the less time needs to be spend for finishing.

When warping with overlapping meshes, you are done with warping as soon as all mesh lines overlay each other. This can be seen easily when both meshes have a different colors as the resulting color will be the sum. The closer the audience sees the projection, the more perfect the overlay needs to be.

In general it is possible to do a rough warp and start programming with it in Pandoras Box. Later on, when there is enough time or when it is sure the projector or screen will not move, you can load the warp project again and finalize it.

### Different ways how to move FFD or mesh points

Depending on your preference you can work either using the mouse or the keyboard, or both. For more detailed information, please see the [Tools bar chapter](#)<sup>802</sup>.

	Mouse	Keyboard
	You might have to unhide the Toolbox by clicking the key [T]. [H] hides it again.	You might have to unselect the Toolbox first by clicking into the Warper's main interface.
Switch the Edit Mode	In the Toolbar, click on - Object  - FFD  - Mesh 	Use the shortcuts - [O] - [F] or - [E]
Select points	Select a single point by simply clicking on it. Select multiple points by holding down [CTRL] additionally. Or, drag a selection box.	Navigate to another selected point by clicking the Up/Down/Left/Right key. Select multiple points by holding down [CTRL] additionally.
Switch the Move Mode	In the Toolbar, click on - Move  - Rotate  - Scale 	Use the shortcuts on the main keyboard - [1] - [2] - [3]
Toggle the Axis Locks (if necessary)	In the Toolbar, click on the according axis button 	Use the shortcuts - [X] - [Y] - [Z]
Edit the selection	To move, rotate and scale, hold the right mouse button and move the mouse up/down or left/right.	To move, hold the [SHIFT] key and click the arrow keys Up/Down/Left/Right

When working with keyboard shortcuts, you can adjust the precision of the arrow presses for positioning the Mesh / FFD points in the toolbox section "[Keyboard / Mouse](#)"<sup>812</sup>.

A third alternative to edit points is to use the [dialog for relative transformation](#)<sup>802</sup>. Left-click on the according mode  to open the dialog. Now you can enter an exact factor for each axis and press "Apply".

The next tutorials explain how to [export your mesh and use it in Pandoras Box](#)<sup>824</sup>, how to work with [associated meshes](#)<sup>825</sup> and how to use the [live warping feature](#)<sup>828</sup>.

### 10.3.2 USING AN OBJECT IN PANDORAS BOX

This chapter explains how a single mesh can be exported from the Warper and be used in Pandoras Box. In the [next tutorial](#)<sup>825</sup> there is an example with a project containing associated meshes.

When you finished your mesh, please export your file in order to use it in Pandoras Box. Choose [File menu](#)<sup>789</sup> > Export Modes > Export selected.

A small browser window opens. Browse to the directory to where you want to export your mesh as an \*.x-file.

It is highly recommended to always save the warping project too. Choose [File menu](#)<sup>789</sup> > Save Settings. Whilst the exported \*.x file contains only the mesh information, the \*.wrp file saves all other settings and the FFD data. If the projector or a screen has moved, for whatever reason, or if you like to fine-tune / finalize your mesh, you can then simply load your warping project file (File > Load Settings) and make your changes.

Open your Pandoras Box application (Pandoras Box Manager, Player or Server). In the [Assets tab](#)<sup>137</sup> browse to the directory to where you exported your mesh. Drag and drop this \*.x-file into the [Project tab](#)<sup>248</sup>. You might need to spread the file. If you have created this file for a specific output (e.g. Output 2), assign it to the according [Output layer](#)<sup>597</sup>. Now all affected layers will be deformed in the same way. If you have created it for only one layer, assign it to an available [Graphic](#)<sup>577</sup> or [Video layer](#)<sup>298</sup>. Both scenarios are depicted in the example below.

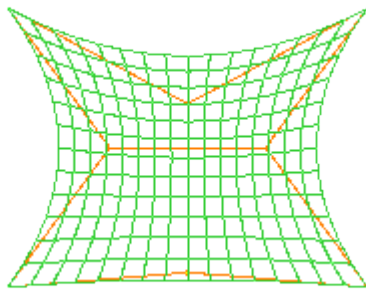

This grid is exported as screen5.x. File menu > Export Modes > Export selected

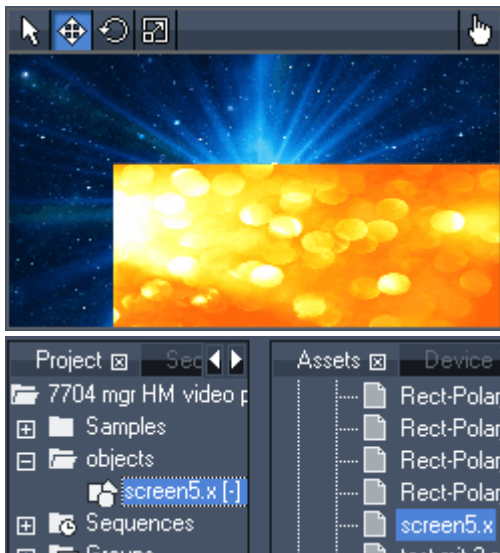

In Pandoras Box there are two layers in use - one for the blue background and one for the orange content. Currently there is no object assigned to any layer, neither to the content layers nor to the output.

The Preview tab is shown in the left image.

The saved object screen5.x is dragged from the Assets tab into the Project tab. Now it is part of the project.



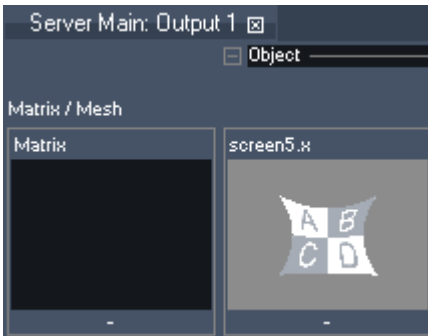
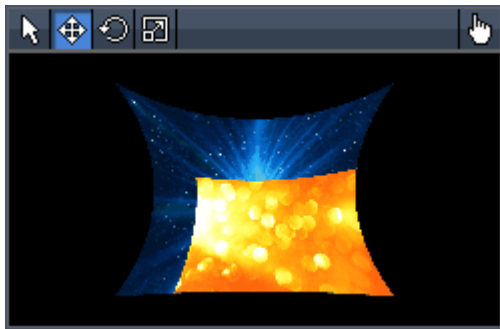

The preview shows the result when the object is assigned to the Output layer, everything is mapped onto the object ...

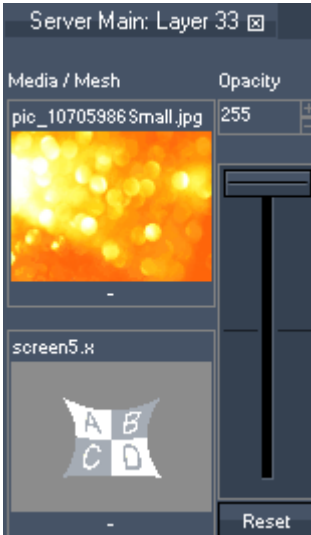
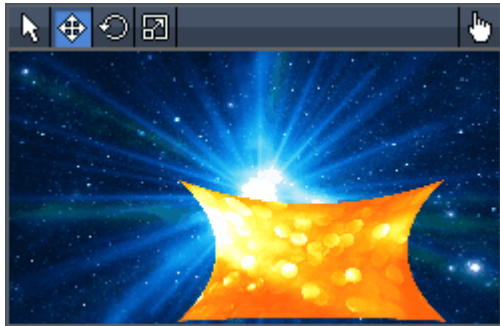

...whereas this would be the result if the object was assigned to the orange layer, and not to the output. As you can see, only the orange layer is deformed, the blue background keeps its original shape.

Please note that it is possible to combine these two ways: you might assign an object to a layer and to the output at the same time. Then, the image will be deformed twice.

### 10.3.3 WARPING WITH SEVERAL MESHES

See here an example for a workflow if you have to project on a screen setup as shown in the image below.



The task is to project on this screen setup in this way:



The screen in the middle should show the whole content. Each of the two side screens should show only the a half of the content.

Important:

If your setup will contain overlapping meshes, please read the information about the [Z-Order](#)<sup>807</sup> as well!

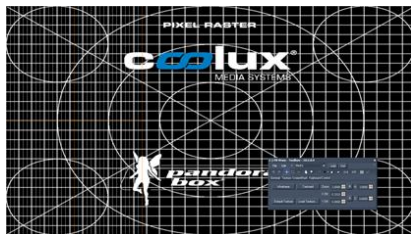

Start with a new warping file. As three meshes are needed, you could create additional meshes with the "Add" button in the [mesh selection from the Menu bar](#)<sup>801</sup>.

Alternatively, choose [File Menu](#)<sup>789</sup> > New... > Triple.

The project contains three side by side meshes as seen in the left image. One texture is applied to all three meshes at the same time.

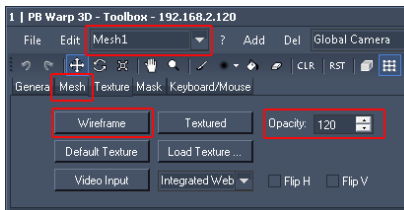

For an easier recognition of an individual mesh, you may alter the texture mode. Open the [Texture tab](#)<sup>808</sup> and click "Wireframe". Or, lower the opacity to a value of 120. If you like to use another texture, click the button "Load Texture", but in this example we will keep the coolux test pattern.

Now, the FFD and mesh lines of the selected mesh are better visible. To change the selection, use the according drop-down menu in the Menu bar (the so called [mesh selection](#)<sup>801</sup>). For the next step, select the leftmost mesh, Mesh1.

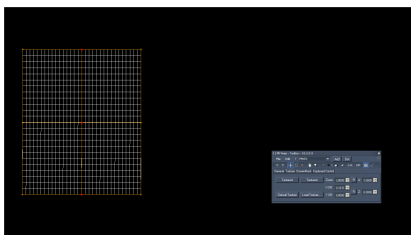

Mesh 1 is now modified in order to cover the first screen in our setup. You can either work with FFD points by moving or scaling a multi-selection of them, or you can scale the entire mesh whilst being in the object mode. The previous tutorial shows different ways how to do this.

First, adjust the outer FFD points so that the borders of your projected mesh exactly fit to the borders of the left screen. The mesh segments should all have the same size as well. This can be adjusted by moving the inner FFD points.

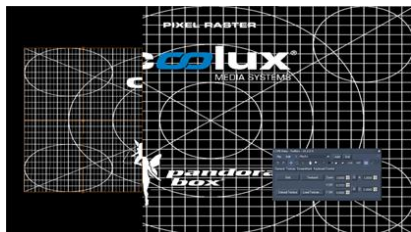

The size of the mesh is Ok, but as seen when switching back to the Textured View, it depicts only third of the content. The task was to show the left half of the content. This is done by influencing the so called [texture map](#)<sup>785</sup>. Please have a look at the current settings in the [Texture tab](#)<sup>808</sup>.

Up until now, the mesh's width is covered with a third of the texture. That means, the entire texture is zoomed with a factor of 3.

At the same time the height is not covered with only a third of the texture, but the entire texture height. Setting the aspect ratio to 3 as well, zooms the height back in.

The last setting is the X Offset. For now, it is set to 0.3333 in order to shift the image 1/3 (of the image width) to the right side.

If you like you can reset the settings and try to find the solution for the task by yourself...

All three settings need to be adjusted to accomplish our task. We would like to:

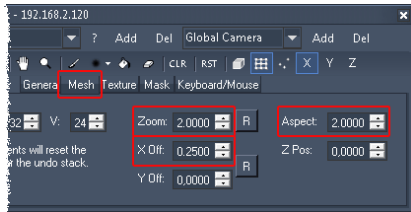

- see half of the content's width => set the Zoom to 2
- see the whole height => set the aspect ratio to the same zoom factor of 2
- see the leftmost pixel row at the left object edge => set the X offset to 0.25

Why 0.25? We see half of the content on the mesh, in other words, one quarter is "behind" the left edge and the other quarter behind the right edge. So, to see the leftmost pixel we must shift the texture by 1/4 of the texture to the right side. One quarter is 0.25 and "to the right" requires a positive value.

Now the texture sits perfectly on the first mesh.

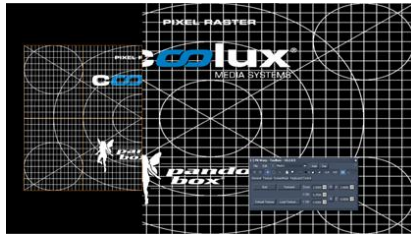

Repeat these steps for the right mesh covering the right side screen. The result is seen left. If your result is different, check the texture mapping. As the texture needs to be shifted to the left, the X Offset should be negative: -0.25



Again, repeat the steps for the center mesh. First, transform the mesh according to the screen it is projected on. Then, adjust the texture mapping for the correct content. This time we would like to:

- see all of the content's width => set the Zoom to 1
- see the whole height => set the aspect ratio to the same zoom factor of 1
- see the leftmost pixel row at the left object edge => leave the X offset to 0

The last thing to do now, is to export the whole scene. Go to File > Export All and choose the file location. All three meshes will be combined in the newly created \*.x-file. Use this object on the Output in Pandoras Box.

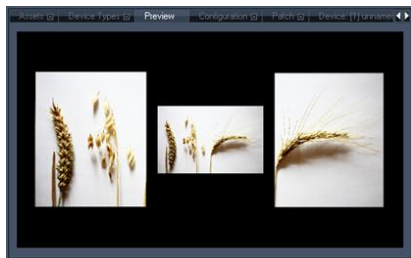

### 10.3.4 LIVE WARPING

The live warping feature (previously known as dynamic warping) allows to have non-static objects on a layer. While projecting, the mesh can be influenced in real-time. Another feature - Morphing - allows to fade between two or three saved meshes.

Please note that those features are not available on Pandoras Box Player Systems!

#### Controlling Pandoras Box via Warper

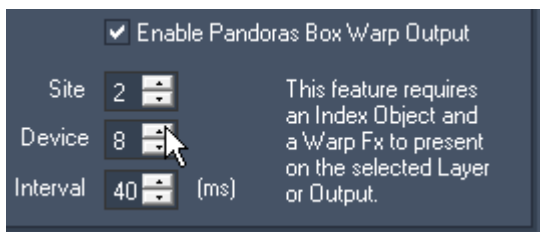
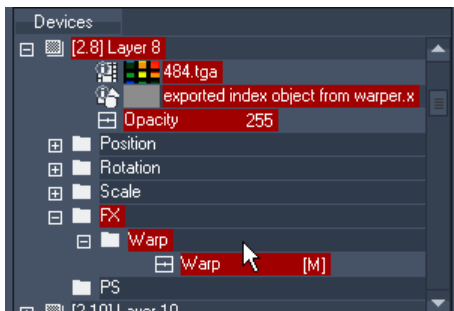
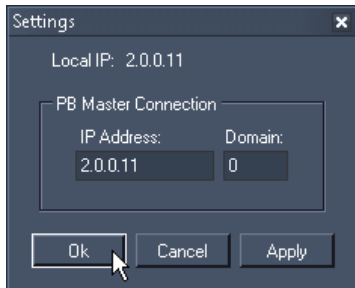

- In the Warper, set up the connection to the Pandoras Box (PB) Master system. To do this go to "Edit" > "[Network Settings](#)<sup>800</sup>".

- For the next steps advanced features will be used, please go to "Edit" > "Advanced Mode" to toggle between the basic and advanced user interface where all features are visible in the menus and tabs.

- [Set up the FFD and mesh count](#)<sup>821</sup> from your mesh you would like to use, or import an object.

- Export the selected mesh as an index object (as the previous mentioned step influences the object, the export has to be done each time you change the FFD and mesh count). To do this go to "[File](#)<sup>789</sup>" > "Export Modes" > "Export Selected as Index Object". Save the \*.x file. If the PB master is connected and a project is opened, all exported objects will be automatically loaded into this project. If you start the project later drag and drop your saved object from the [Asset tab](#)<sup>137</sup> to the [Project tab](#)<sup>248</sup>.

- In PB, choose which layer (or output) you want to warp live. First of all assign a media file to it and make sure the opacity is on. Then go to the Project tab and assign the exported object as a mesh to the layer. The layer will now be stretched as if it was one line. Go to the "[Aeon FX](#)<sup>136</sup>" tab > Folder "Warp" > drag the effect "Warp" onto the layer. Note that this effect has no parameters, you will not see it in the Device Control itself. Only when opening the FX parameter in the [Device Tree](#)<sup>168</sup> you see the effect. The effect cannot be turned off like other effects, the only way to deactivate it, is to delete it entirely.

- In the Warper, go to the tab "[Live Warp](#)<sup>819</sup>", tick the check box "Enable Pandoras Box Warp Output" and set up the site and device whereto you assigned the object and the effect in PB.

- Now, as soon as you edit the FFD or mesh in the Warper the layer in PB will not look like one

line anymore. From now on it is influenced in real-time according to the mesh in the Warper.

**Controlling Warper via Pandoras Box / another Art-Net Device**



- As this feature is based on an Art-Net communication make sure that Pandoras Box and the Warper are set to an IP address 2.x.x.x and Subnet Mask 255.0.0.0.

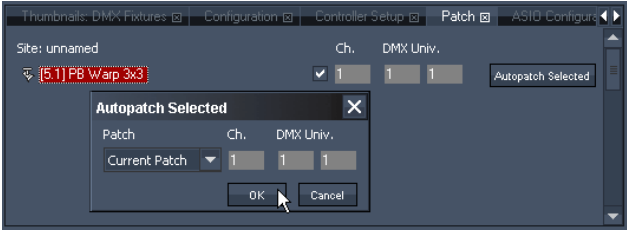

- In Pandoras Box go to the "Device Types" tab [181] > "DMX Fixtures" > "COOLUX" > and drag the "PB Warp 3x3.clib" into the Device Tree.

- Now select the warp device and go to the "Patch" tab [222] to patch it, for example to Channel 1 on Subnet / Universe 1/1 .

- Lastly, go to the "Configuration" tab [139], open the section "Remote Control Protocols" and press the button Art-Net "Activate Output".

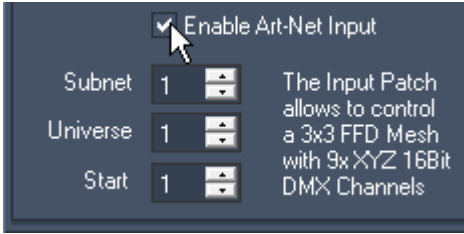

- In the Warper, set up a mesh with an FFD count of 3 x 3 and a mesh count of your choice.

- Go to the "Live Warp" [819] tab, tick the check box "Enable Art-Net Input" and patch the Channel as done in the previous step.

- Now, as soon as you change the parameters within the warp device in PB, the FFD points and therefore the mesh are influenced.

- Instead of the warp device in PB you can use any Art-Net sending device to control the FFD in the Warper.

- Of course this feature can be combined with the above mentioned feature and the Warp FX. If you do this you are limited to a 3 x 3 FFD.

**Morphing between several objects**



- In the Warper, first of all open the "Edit" [794] menu and activate the "Advanced Mode". Then set up the FFD and mesh count [821]. Export the mesh as an Index Object. This has to be done only once, as long as you do not change the FFD and mesh count anymore.

- Then deform the mesh as you wish to have it when starting the morph process.

- Export this state as the first Morph Target (as the previous mentioned step influences the file, the export has to be done each time you change the mesh). To do this go to "File" [789] > "Export Modes" >

"Export Selected as Morph Target". Save the \*.png file. If the PB master is connected and the Warper is set to its IP address and domain and if a project is opened, all exported objects will be automatically loaded into this project. If you start the project later drag and drop your saved object from the [Asset tab](#) <sup>137</sup> to the [Project tab](#) <sup>248</sup>.

- Do the same for the second (and third) status of the mesh. These states represent the in-between look or how you wish to have the deformation when the morph process is finished.
- Alternatively, you can also save one morph target per frame, meaning that each morph target represent a step from the transformation. (Some programs can export a movement from objects as an object sequence - a folder consisting of several \*.3ds, .obj or .x files. To convert all of them in one step to be used as a morph target, choose the option File > [Convert Object Seq to Morph Target](#) <sup>789</sup>.

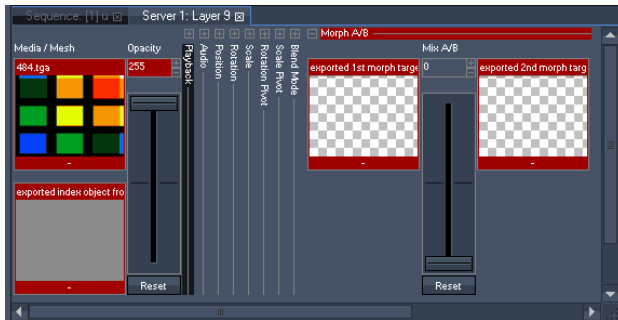

- In PB, choose which layer (or output) you want to morph between the meshes. First of all assign a media file to it and make sure the opacity is on. Then go to the Project tab and assign the exported object as a mesh to the layer.

- Go to the "[Aeon FX](#)" <sup>136</sup> tab > Folder "Geometry" > drag the effect "Morph A-B" (or "Morph A-B-C") onto the layer. Then, again, go to the Project tab and assign the exported morph targets as effect medias.

- When you have a morph sequence, import it as an [image sequence](#) <sup>99</sup> in Pandora's Box or convert it to an \*.avi video file, e.g. using the coolux tool [Image Converter](#) <sup>838</sup> or to a lossless video format from the [coolux codec](#) <sup>115</sup>.
- Go to the "[Aeon FX](#)" <sup>136</sup> tab > Folder "Warp" > drag the effect "[Warp Target](#)" <sup>576</sup> onto the layer.
- Assign the morph image sequence or video to the effect.

## 10.4 KEYBOARD SHORTCUTS

[F1]	– Help
[T]	– Show Tools
[H]	– Hide Tools
[S]	– Select Mode
[M]	– Move Mode ([1] Pos, [2] Rot, [3] Scale)
[F]	– FFD Mode
[E]	– Edit Points Mode
G	– Toggle Grid / Textured View
[Space]	– Play/Pause Video Texture
[D]	– Toggle Face Visibility
[ESC]	– Clear Selection
[CTRL+A]	– Select All
[R]	– Reset Offset of Selected Points
[Up]	– Selection Up
[Down]	– Selection Down
[Right]	– Selection Right
[Left]	– Selection Left
[Shift]+[Up]	– Move Selection Up
[Shift]+[Down]	– Move Selection Down
[Shift]+[Right]	– Move Selection Right
[Shift]+[Left]	– Move Selection Left
[CTRL]+[Up]	– Multi-select Up
[CTRL]+[Down]	– Multi-select Down
[CTRL]+[Right]	– Multi-select Right
[CTRL]+[Left]	– Multi-select Left

## 11 LEICA 3D DISTO



setup times significantly.

The Leica 3D Disto tool comes automatically with the installation of a Pandoras Box Manager. It is accessible in the "Tools" menu. The tool requires that the Leica hardware, specifically the 3D Disto, is connected and the drivers are installed. Please note, that the distometer cannot be purchased through your local distributor but we are happy to forward contact details.

In short, the motorized distometer measures points with great accuracy and in return can laser to any point, measured before. It draw our attention as it can be used in complex 3D scenarios to measure projector positions and object position. It reduces

## 12 DOME MASTER

The Dome Master is a spherical map converter that allows the conversion of dome master files to spherical map files. Its sub-pixel accuracy allows optimum image sharpness for large scale projections.

Input formats:

- Bitmap (.bmp),
- GIF (.gif),
- JPEG (.jpg),
- PNG (.png),
- PSD (.psd),
- TGA (.tga),
- TIF (.tif),
- TIFF (.tiff).

Output formats:

- BMP 24bit (Bitmap, RGB),
- BMP 32bit (Bitmap, RGB+Alpha),
- PNG 32 bit (RGB+Alpha),
- AVI Sequence

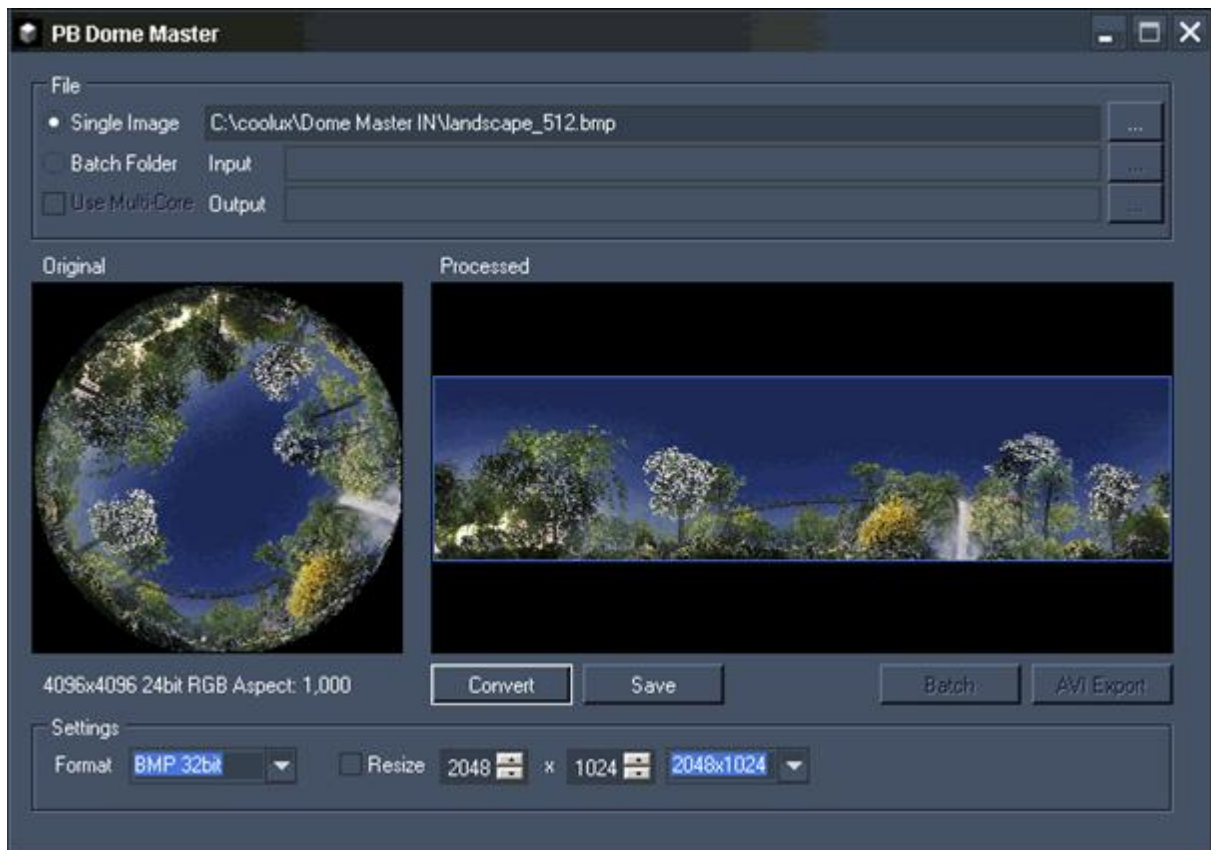

Loaded image: Courtesy of Triad, Berlin



## 12.1 WHAT IS A DOME MASTER?

A Dome Master file describes a sphere or a hemisphere as circular image within a square. The outer edge of the circle corresponds to the dome's equator, the circle's center point corresponds to the dome's pole.

To map content to 3D spheres or Dome Warpings it is reasonable to convert Dome Master files to spherical maps. These spherical maps will have the aspect ratio 2:1 (full sphere) or 4:1 (hemisphere).

The Dome Master Converter allows a 1:1 conversion via pixel blending to achieve the best quality for the spherical map. Due to this process it can take a longer time for the conversion.

## 12.2 DOME MASTER USER INTERFACE

The Dome Master User Interface is divided into three sections: [File](#)<sup>834</sup>, [Image](#)<sup>834</sup> and [Settings](#)<sup>837</sup>.

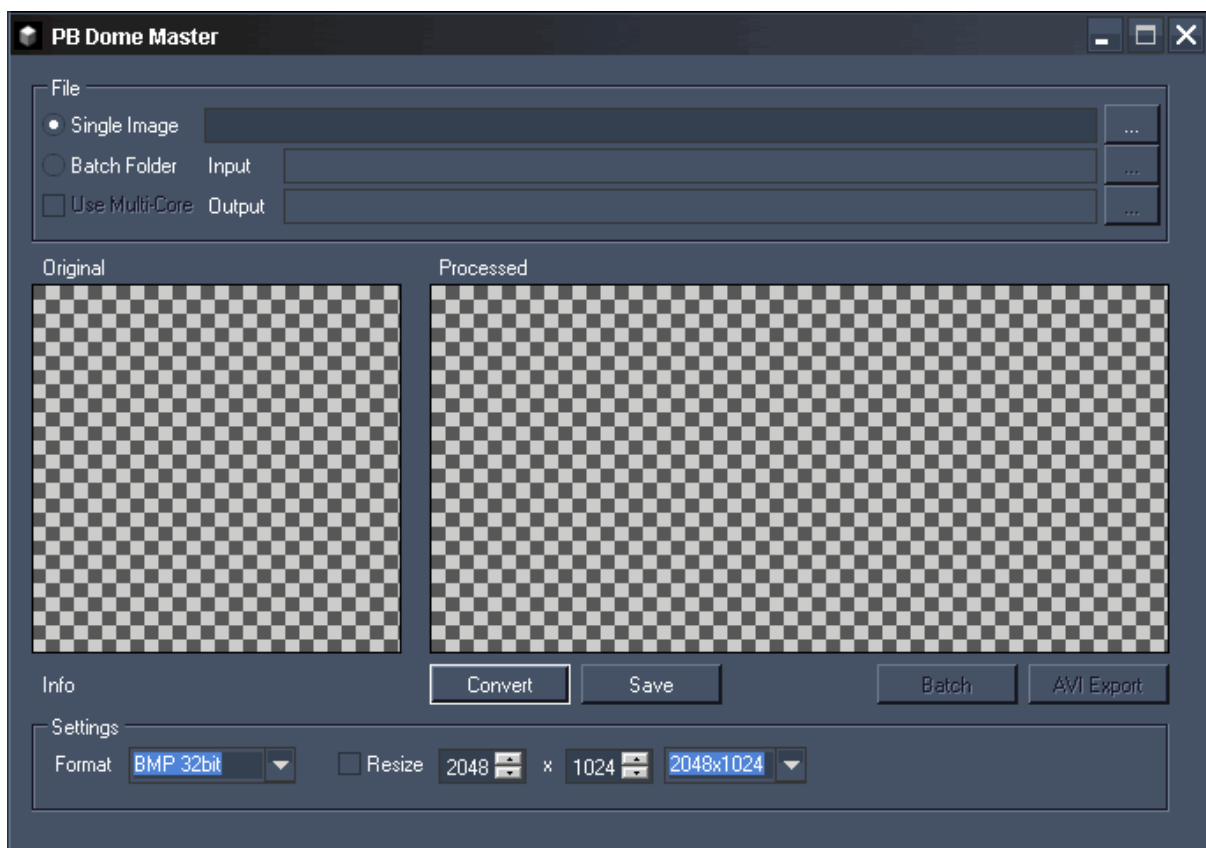

### 12.2.1 FILE

To process files with the Dome Master you may do it image by image or as batch conversion.



Single Image conversion:

Select [Single Image] and then Click on [...] to browse to your file's location to convert a single Dome Master file.

The file will be displayed on the left side in the Image section.

Batch Conversion:

Select [Batch Folder] and click [...] to choose the folder where all of the Dome Master Files are located. You have to define an output folder as well, where the converted files will be stored.

The first file from the Input folder will be displayed on the left side in the Image section.

You may want to enable the option [Use Multi-Core] to split the conversion process evenly over all available cores of your computer for faster conversion.

### 12.2.2 IMAGE

On the left side you will see the original image you loaded to the Dome Master Converter.

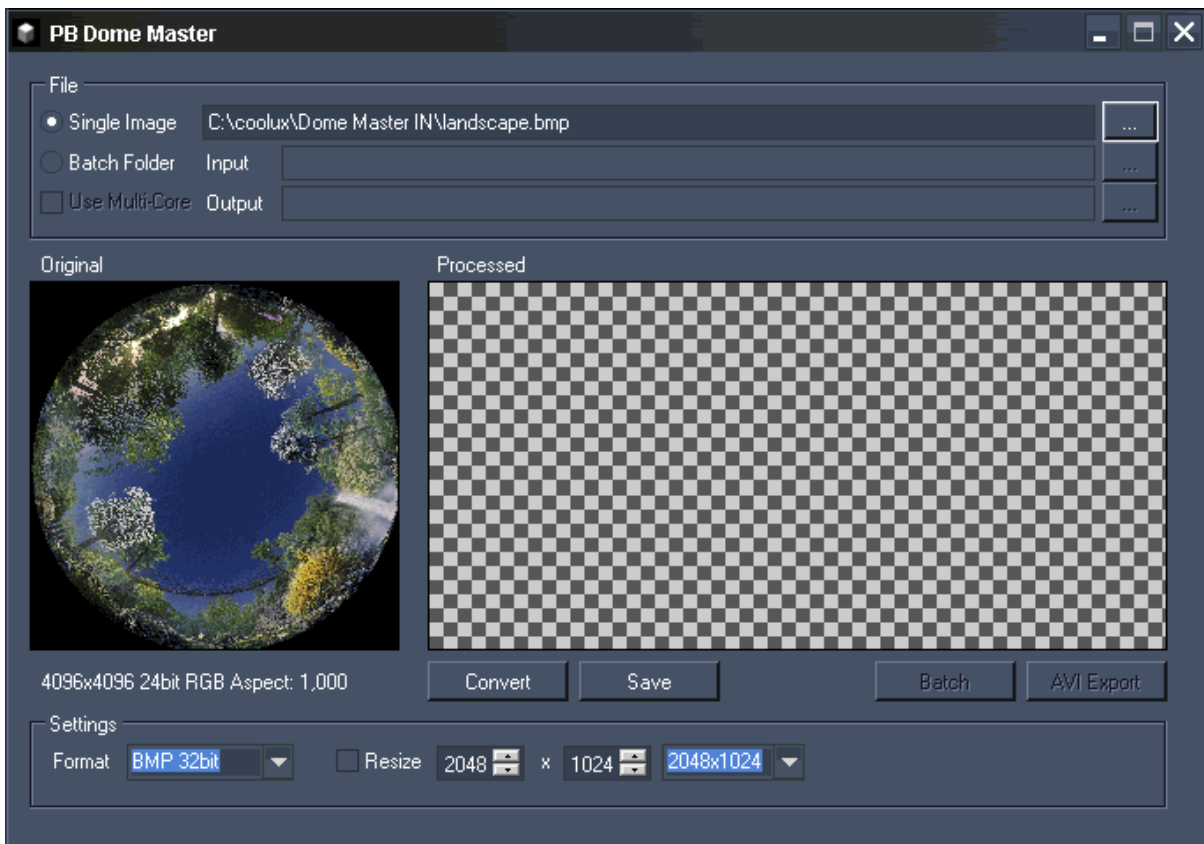

Loaded image: Courtesy of Triad, Berlin

[Convert]:

Press this button to convert the image. Per default (without using the Resize option in the Info section) the image will be converted in the according image size with the aspect ratio 4:1 and the file format chosen under [Format]. The processed image will be displayed on the right side.

For example:

Converting an image with the native size 4096x4096 px, will result in the image size 8192x2048 px.

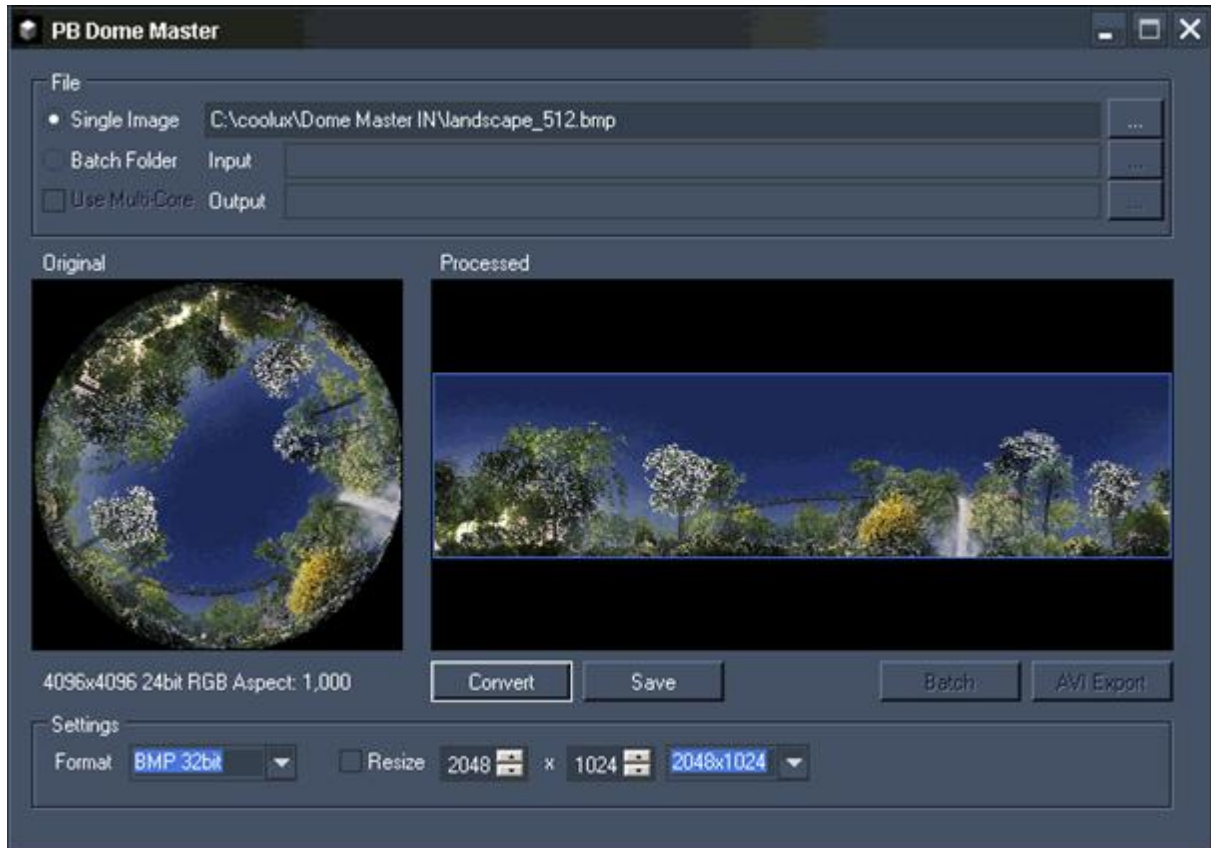

Loaded image: Courtesy of Triad, Berlin

#### Saving a single image:

To save this single image just press [Save] and choose the location where to save it.

#### Saving and converting files from batch folder:

If you loaded a whole file folder for batch conversion, you may press [Batch] now to start the conversion process. This will deliver single Bitmap images in your output folder.

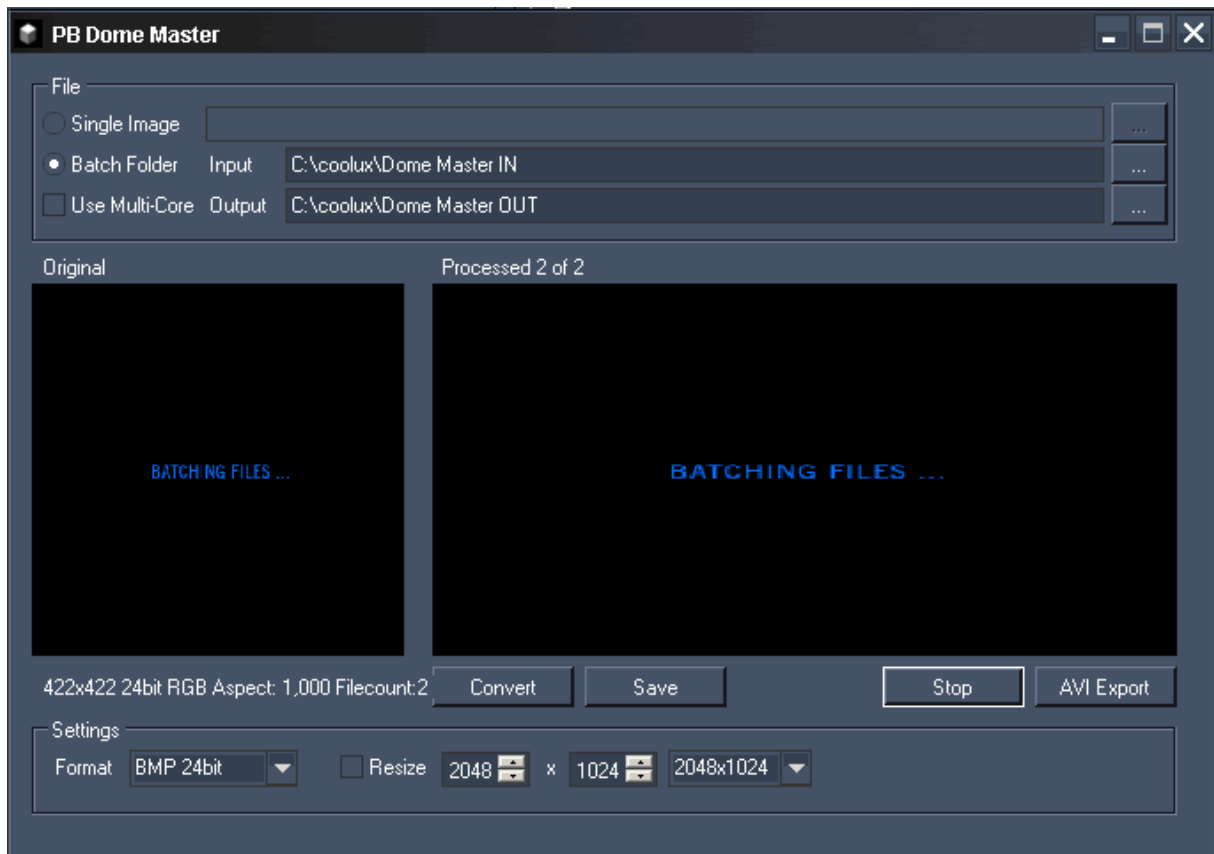

While the batch conversion process is running, the message “Batching files ...” is displayed in the image fields.

To skip the batch conversion process press [Stop].

To create a video out of all files located in the Input folder, press [AVI Export] instead of pressing [Batch]. A pop-up dialog opens up.

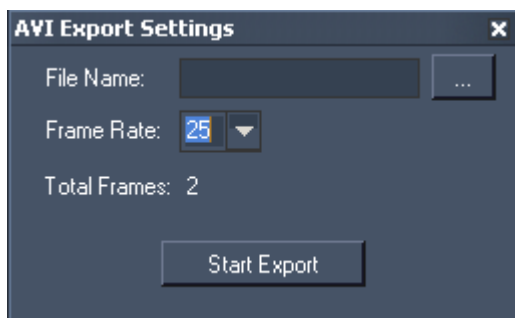

**File Name:**  
Choose a File Name for your AVI video and use [...] to browse to the location where it should be stored.

**Frame Rate:**  
Choose the Frame Rate out of the following ones:

24, 25, 30, 50 and 60 Frames per Second.

Now press [Start Export] and your AVI video will be created.

### 12.2.3 SETTINGS

Use this section to define the image's output settings.

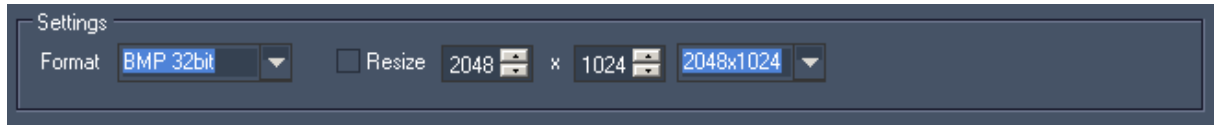

**[Format]:**

Choose one of the following image formats for the processed spherical maps:

- BMP 24bit (Bitmap, RGB),
- BMP 32bit (Bitmap, RGB+Alpha),
- PNG 32 bit (RGB+Alpha).

**[Resize]:**

By default this option is disabled. Converting images without Resize enabled will result in images with the aspect ratio 4:1 and the file format chosen under [Format].

If you want to resize the image, enable [Resize] You now may choose one of the settings from the drop down list on the right or enter the new values for Width and Height manually in the text fields.

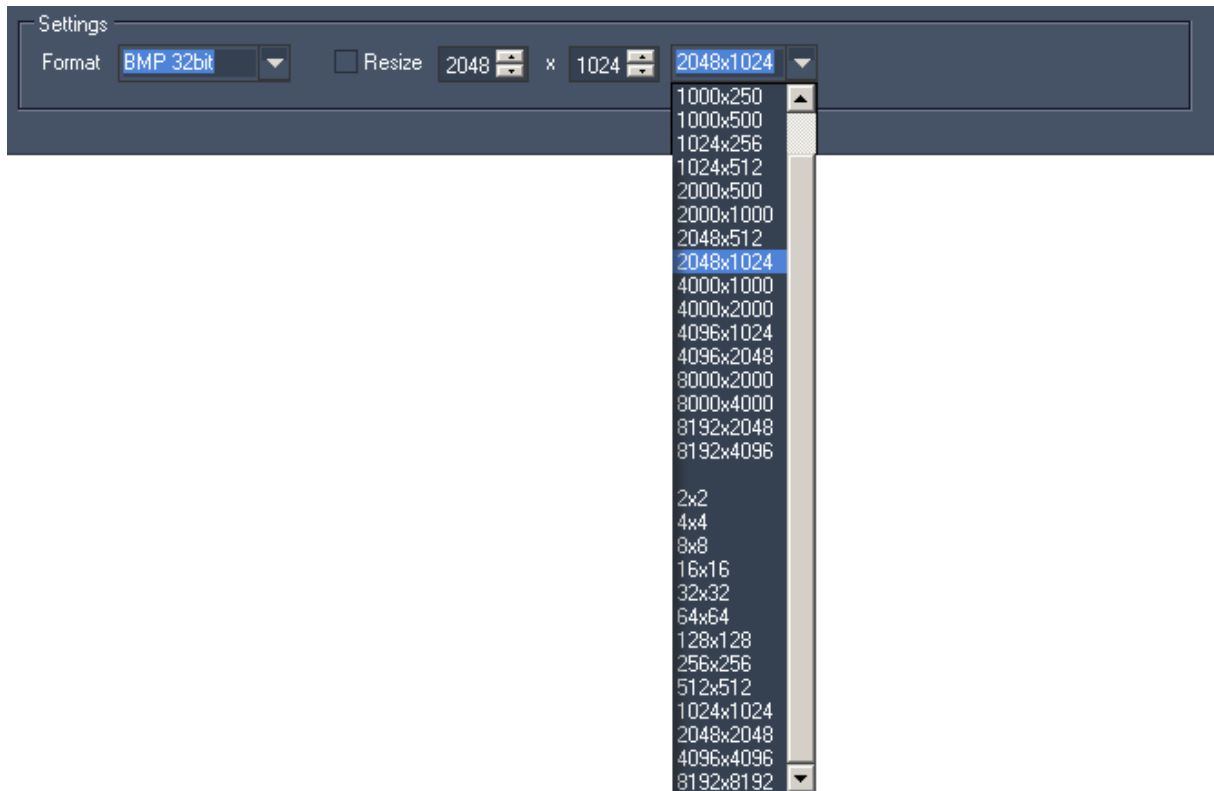

### 13 IMAGE CONVERTER

The Image Converter is a tool for content preparation and modification, and can be used to increase the performance of the PB Playback system.

The Image Converter allows to process either single images or - as it supports batch processing -entire [image sequences](#)<sup>99</sup>. It resizes images to smaller file sizes or it converts the format. In addition it may export an image sequence as a mpeg or an avi video. You may choose to read the frames forwards or backwards.

Since version 5.1 it is possible to extract an additional black and white movie to be used as a mask for keying in Pandoras Box. This is the most recommended workflow when an alpha (transparent) channel is needed in videos!

When you work with large, high resolution multi-softedged projections, you might be interested in a tool that splits images in order to have separate playback videos per client. Please have a look at another coolux product, the [Splitter](#)<sup>848</sup>.

The following pages explain the [user interface](#)<sup>839</sup>.

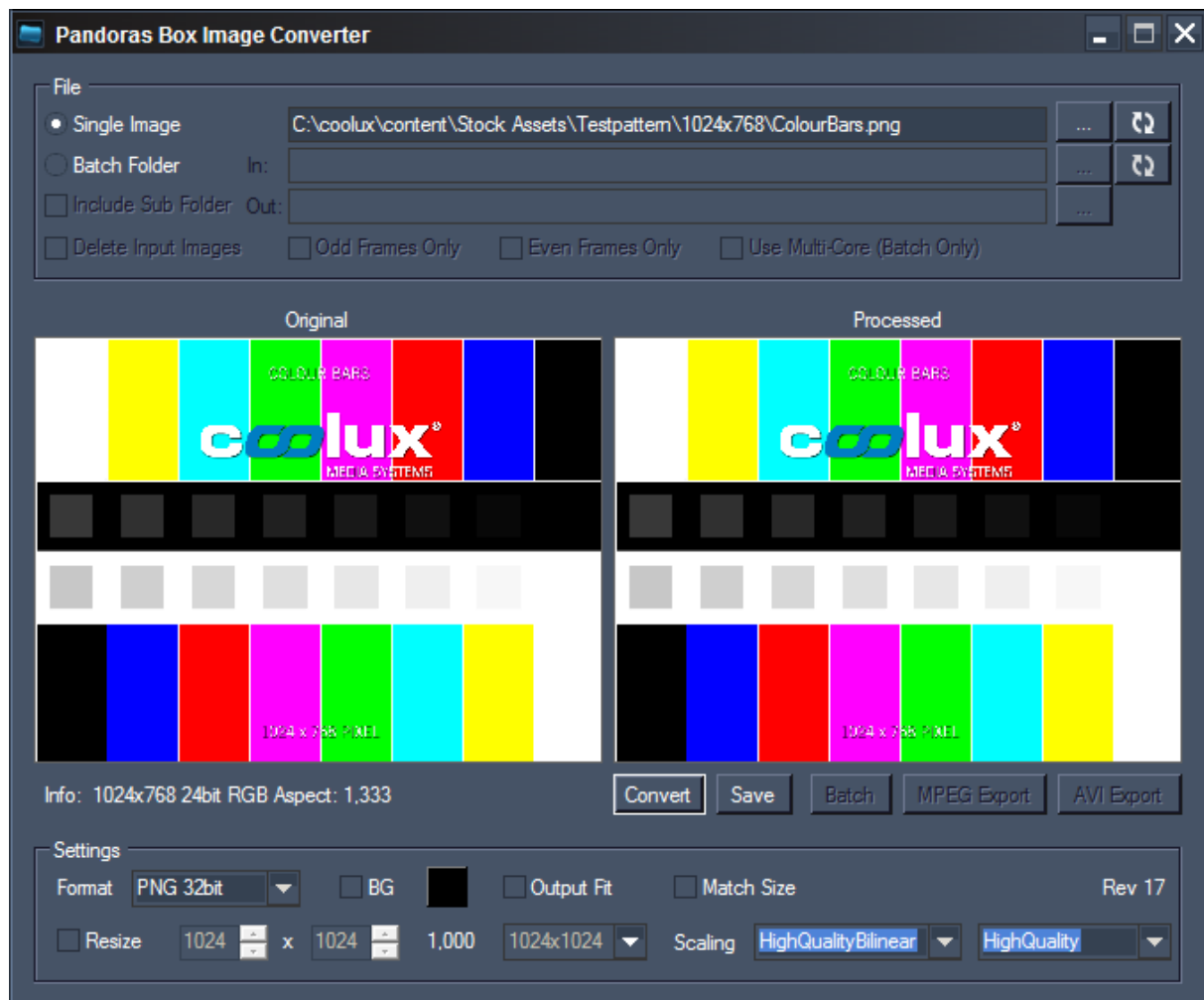

### 13.1 IMAGE CONVERTER USER INTERFACE

The Image Converter User Interface is divided into three sections: [File](#)<sup>839</sup>, [Image](#)<sup>840</sup> and [Settings](#)<sup>843</sup>.

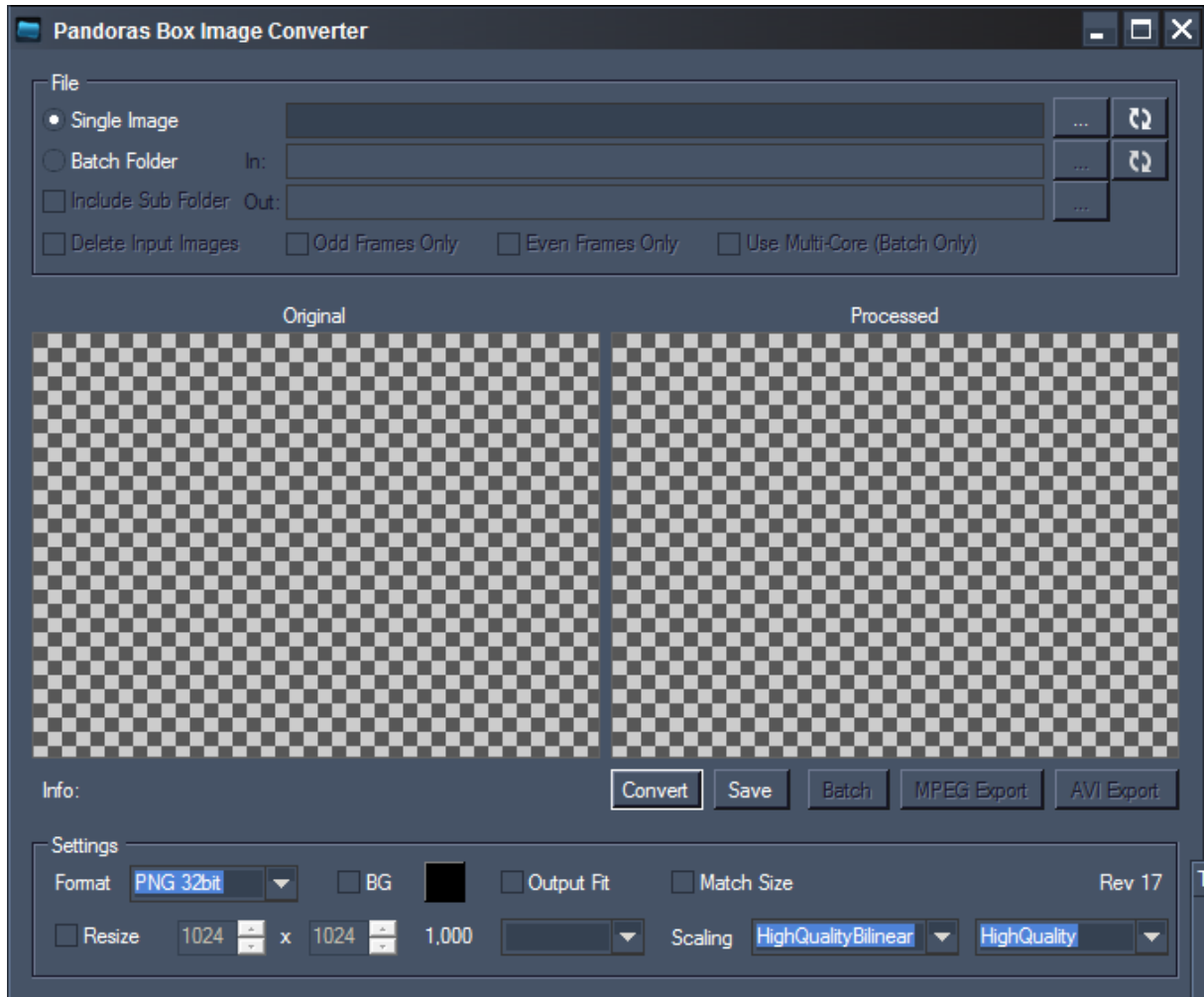

#### 13.1.1 FILE

To process files with the Image Converter you may do it image by image or as batch conversion.

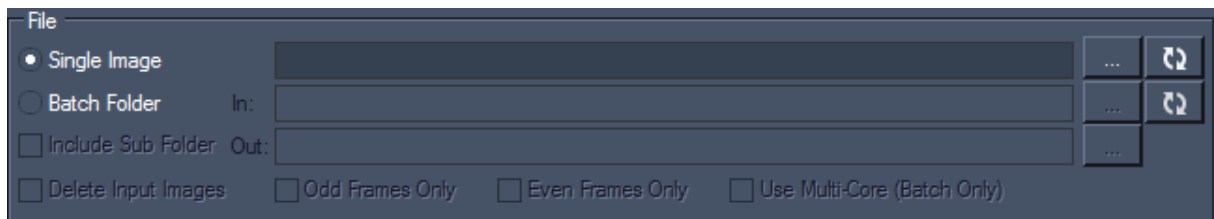

#### Possible input formats

- Bitmap (.bmp)
- GIF (.gif)
- JPEG (.jpg)
- PNG (.png)
- PSD (.psd)
- TGA (.tga)

- TIF (.tif)
- TIFF (.tiff)

### Single image conversion

Select [Single Image] and then Click on [...] to browse to your file's location to convert a single image file to a new size.

The file will be displayed on the left side in the Image section.

### Batch folder conversion

Select [Batch Folder] and click [...] to choose the folder where all of the image files are located. You have to define an output folder as well, where the converted files will be stored.

The first file from the Input folder will be displayed on the left side in the Image section.

### Additional options (Batch folder conversion only)

#### Include Sub Folder

Recursively searches for images in subfolders.

#### Use Multi-Core

Enables the Image Converter to use multiple processor cores, this uses more system performance but is accordingly faster.

#### Delete Input Images

Removes the source images after conversion.

#### Odd/Even Frames Only

Tells the Image Converter to convert only odd or even images. This useful when getting an image sequence that is produced for 3D-content where the first, third, fifth... frame is for the right eye and the second, forth, sixth... frame contains the information for the left eye. A typical framerate would be for example 120Hz. With the feature you may separate the right and left content and render two videos to be played back with 60Hz.

## 13.1.2 IMAGE

On the left side you will see the original image you loaded to the Image Converter.

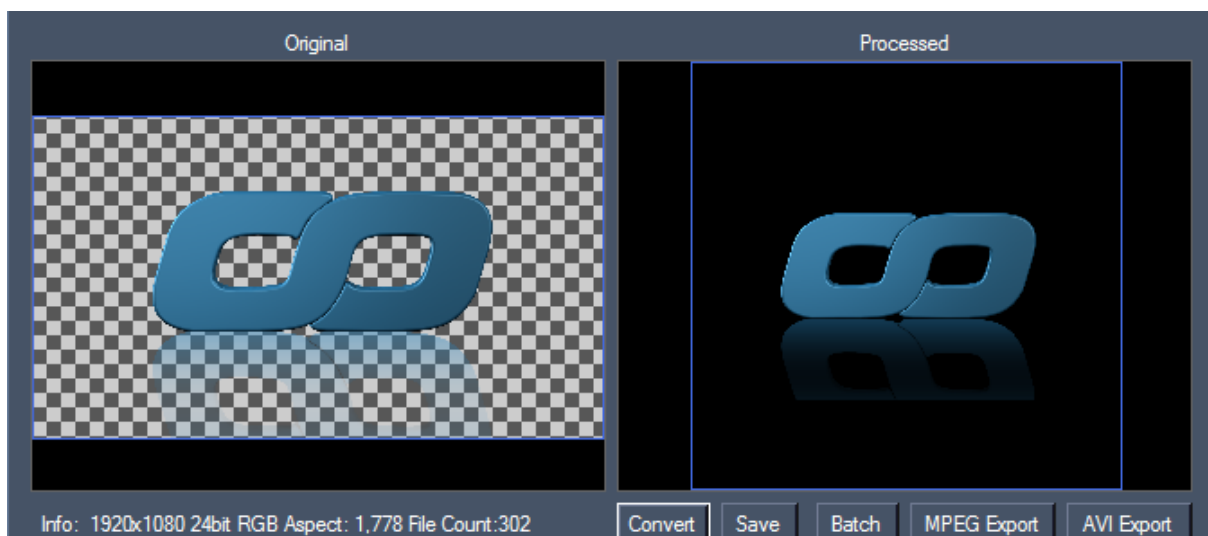



Below the image you see the format information of the currently loaded image: Size, Colour Depth and Aspect Ratio. For batch conversion, it also shows you the file count.

The image size in the example above is 1920x1080 px, its colour depth is 24 bit (containing RGB + Alpha) and the aspect Ratio is 1,778 (=16/9).

### Converting single images

To convert a single image press the button "Convert". Per default (without using the resize option in the info section) the image will keep its size and it will be converted into the file format of your choice. The processed image will be displayed on the right side.

Once you converted the image, you can export it using the save button.

### Converting multiple files (batch conversion)

To start, choose the batch conversion mode. Now you can specify the path to the folder where all your source images are located in. After that you will need to specify the target folder right below the source folder. Once you have set up both paths, adjust the conversion settings to suit your needs. Finally press the "Batch" button to start. While the batch conversion process is running, the message "Batching files ..." is displayed in the image fields.

To skip the batch conversion process press "Stop".

### Converting images to an .avi movie

Do the same as described above in the section "Converting multiple files". Instead of using the "Batch" button you click the "AVI Export" button. The following dialog will be shown:

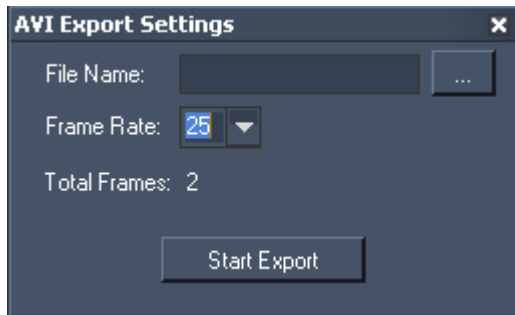

#### File Name

Choose a File Name for your AVI video and use [...] to browse to the location where it should be stored.

#### Frame Rate

Choose the framerate in FPS (frames per second). Possible values are 24, 25, 30, 50 and 60.

Now press the "Start Export" button and your AVI video will be created.

## Converting images to a .mpg movie



The MPEG export feature allows you to render a sequence of images to a mpeg file.

Enter a file name and click the [...] button for determining the entire file path.

Choose the appropriate frame rate and the playback direction. "Bounce" will play all images forward and then once again in reversed order.

The alpha splitting section gives you the possibility to maintain the alpha channel when converting to the mpeg format. The mpeg format was originally specified as a codec not supporting the alpha channel. Therefore the Image Converter enables the following workflow: First the main mpg video that naturally supports RGB only is generated, then an additional mpeg is saved which holds the original transparency information in terms of a black and white mask. In Pandoras Box dedicated effects merge the main video and the mask video resulting in one video with transparency.

**Split** Splits color and alpha information into two separate tracks.

In Pandoras Box, use the effect [Alpha Media as Mask](#)<sup>500</sup>

**Top Bottom / Left Right** The color information is rendered to the top/left half of the video. The other half contains the alpha information.

Please note that this option lowers the image quality but saves playback performance.

In Pandoras Box, use the effect [Alpha Top Bottom](#)<sup>500</sup>, respectively Alpha Left Right

**Top Bottom / Left Right HQ Double Resolution** The video height/width is doubled. The alpha information is stored as a black&white video attached at the bottom/right of the video.

Other than the above option, the quality is preserved. On the other hand the playback takes more processing power!

Choose a "Mpeg Encoding Preset" or define a custom setting. The encoder is based on the Pandoras Box Encoder Extension, please find more [detailed descriptions for the encoder settings](#)<sup>107</sup> here, including recommendations regarding the bitrate setting.

Click "Start Export" to confirm all settings. When the process is finished a dialog will pop up.

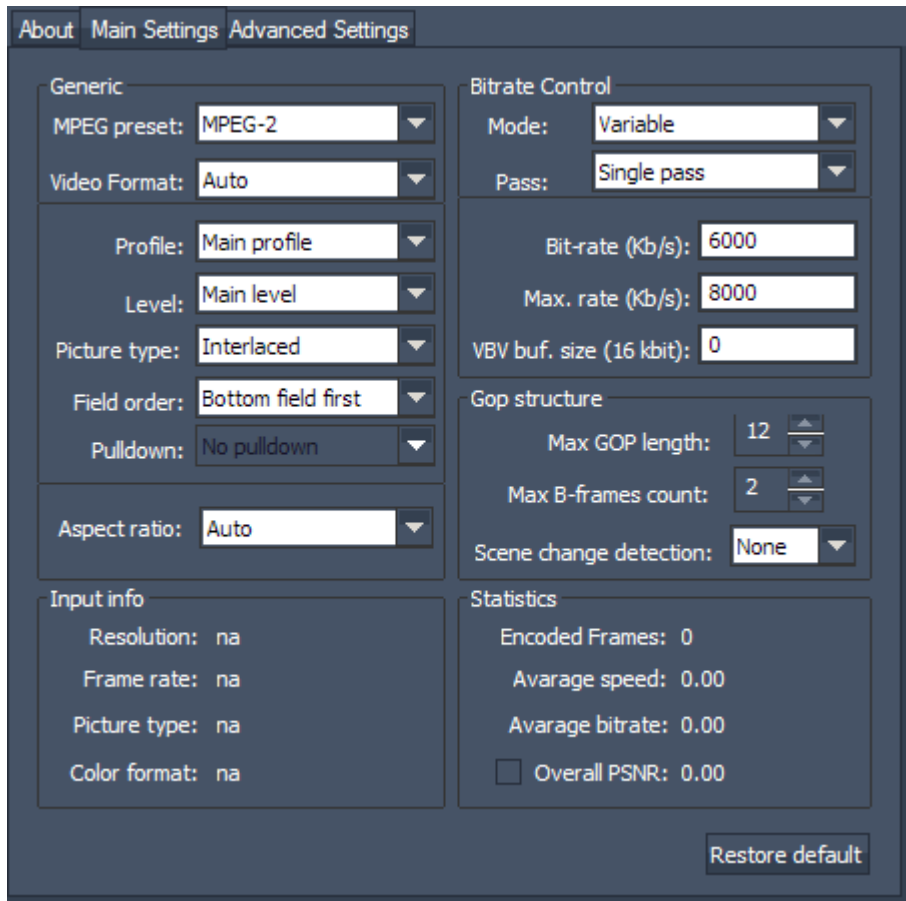

The advanced settings make in depth configuration of the MPEG encoder possible.

The maximum resolution for an mpg2 video is 4094x2800 px, though it is recommend to set 4080x2800 px as this conforms with the mpeg standard. The encoding process depends on available graphic card RAM.

For further information regarding the encoder settings please see the [Encoder Extension](#)<sup>[103]</sup>.

### 13.1.3 SETTINGS

Use this section to define the image's output settings.

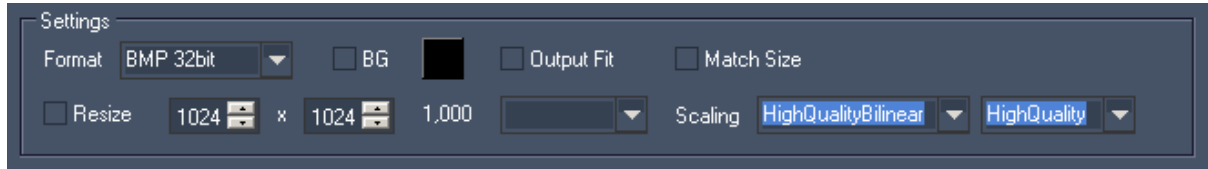

[Format]:  
 Choose one of the following image formats for the converted images:  
 BMP 24bit (Bitmap, RGB),  
 BMP 32bit (Bitmap, RGB+Alpha),  
 PNG 32 bit (RGB+Alpha).

[Resize]:  
 By default this option is disabled. Converting images without Resize enabled will result in images with their original size and the file format chosen under [Format].

If you want to resize the image, enable [Resize] You now may choose one of the settings from the drop down list on the right or enter the new values for Width and Height manually in the text fields.

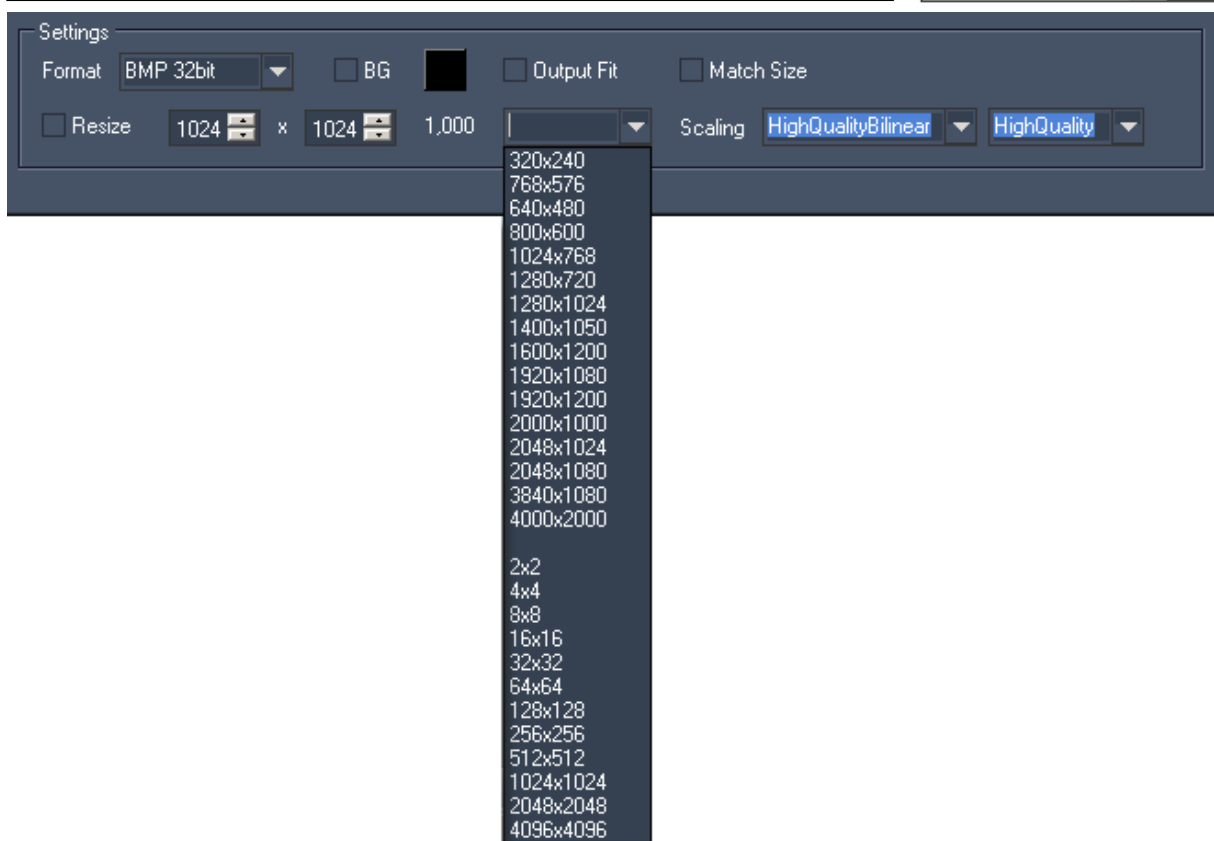

**[Match Size]:**

This option allows to easily resize the image to any size without having to calculate the correct Width and Height to keep the image's original aspect ratio.

**Example:**

To convert an image file with the size 2560x1200 px (aspect ratio is 2,133) to a file that is 1000 px wide, you have two options:

Not using [Match Size]

Enter the new values for Width and Height manually into the text fields: Width = 1000px, Height = 469 px. This assumes that you know (or calculate) the Height to keep the correct Aspect Ratio.

Using [Match Size]:

If you don't want to calculate the value for the according Height, just enter the Width value (=1000) and then enable the [Match Size] option. Now press [Convert]. The new image size is displayed next to [Match Size]: 1000x469 px.

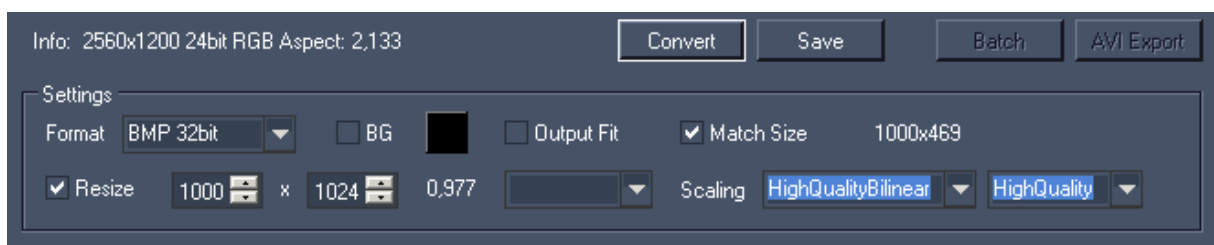

**[BG (=Background)]:**

This option allows to replace transparent image parts with a background colour. Enable the option and click on the small box next to [BG] to choose the background colour.

Example 1:

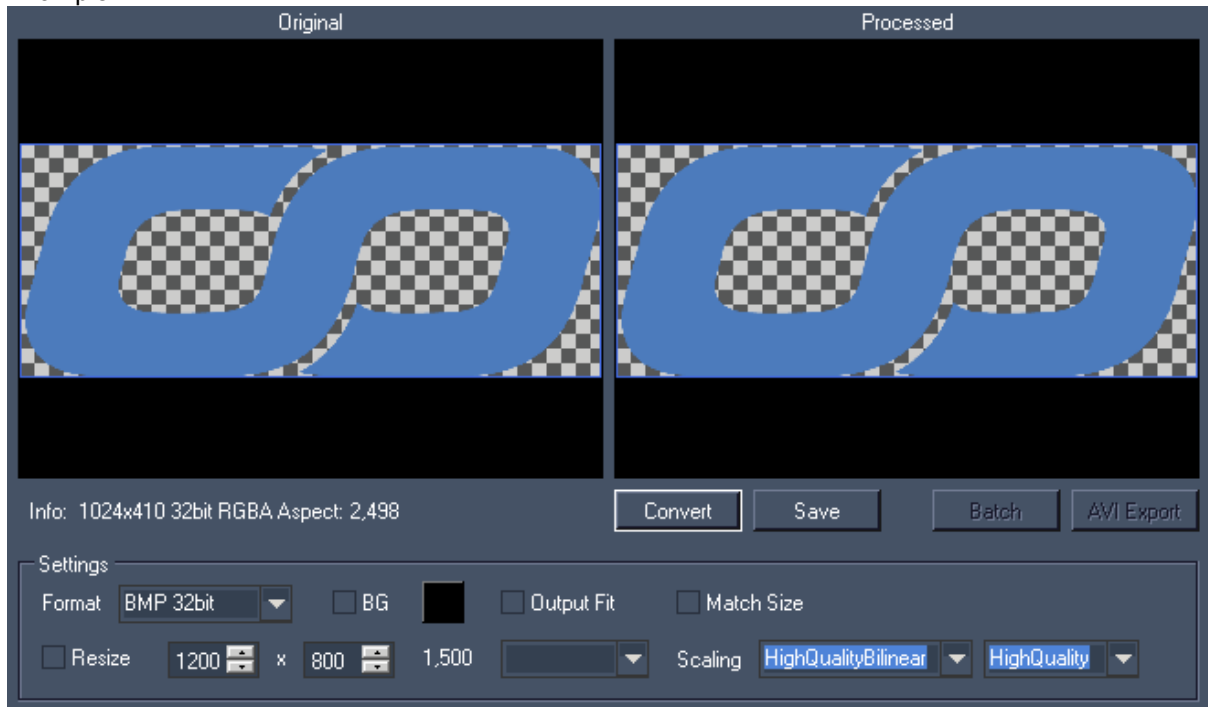

The coolux oo-logo contains transparent parts. Converted with [BG] disabled: the transparent parts will be kept.

Example 2:

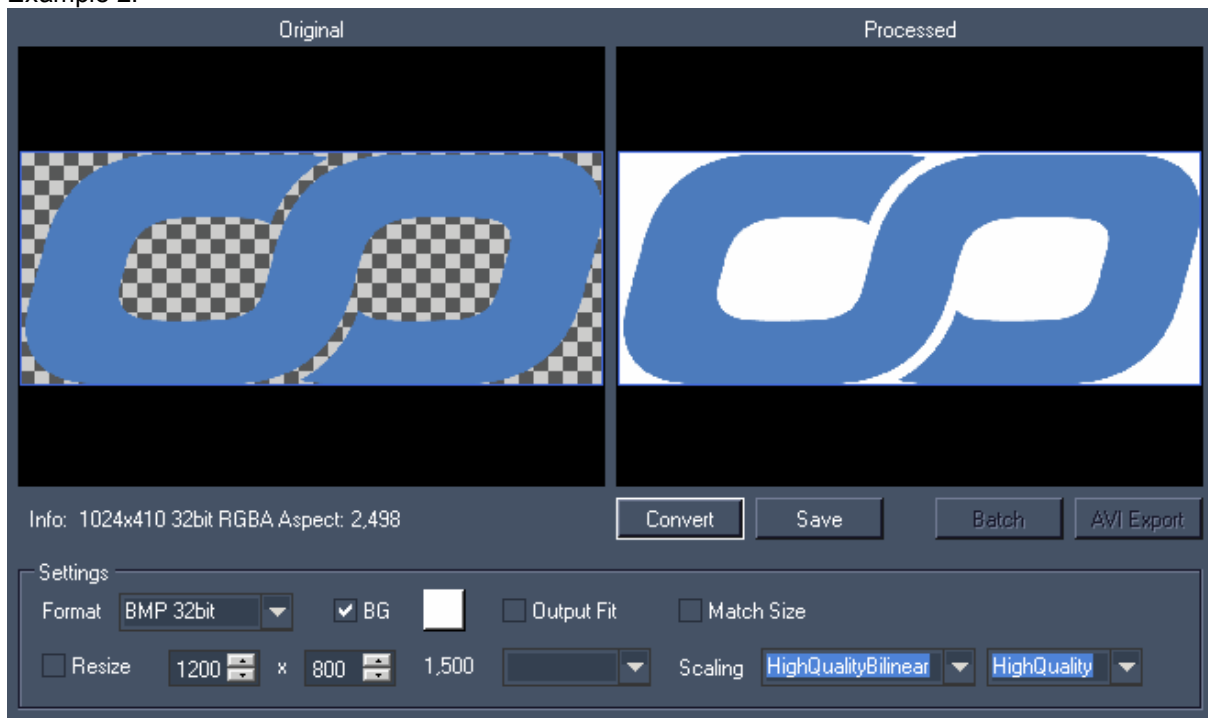

The same logo is converted with [BG]-option enabled, a white BG colour is chosen: the former transparent parts on the logo are replaced by white.

[Output Fit]:

This option allows to resize an image to a size with a different aspect ratio without stretching the content.

Example 1:

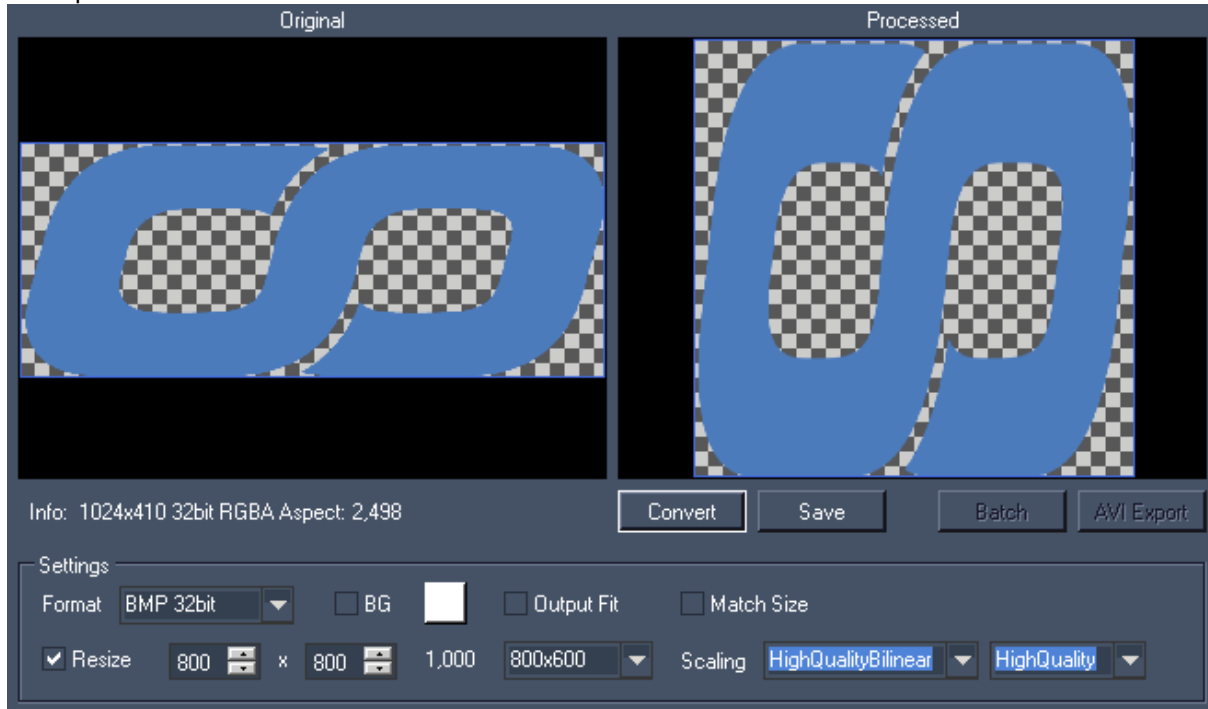

The logo (size 1024x410 px) is resized to 800x800 px. The result is a stretched image.

Example 2:

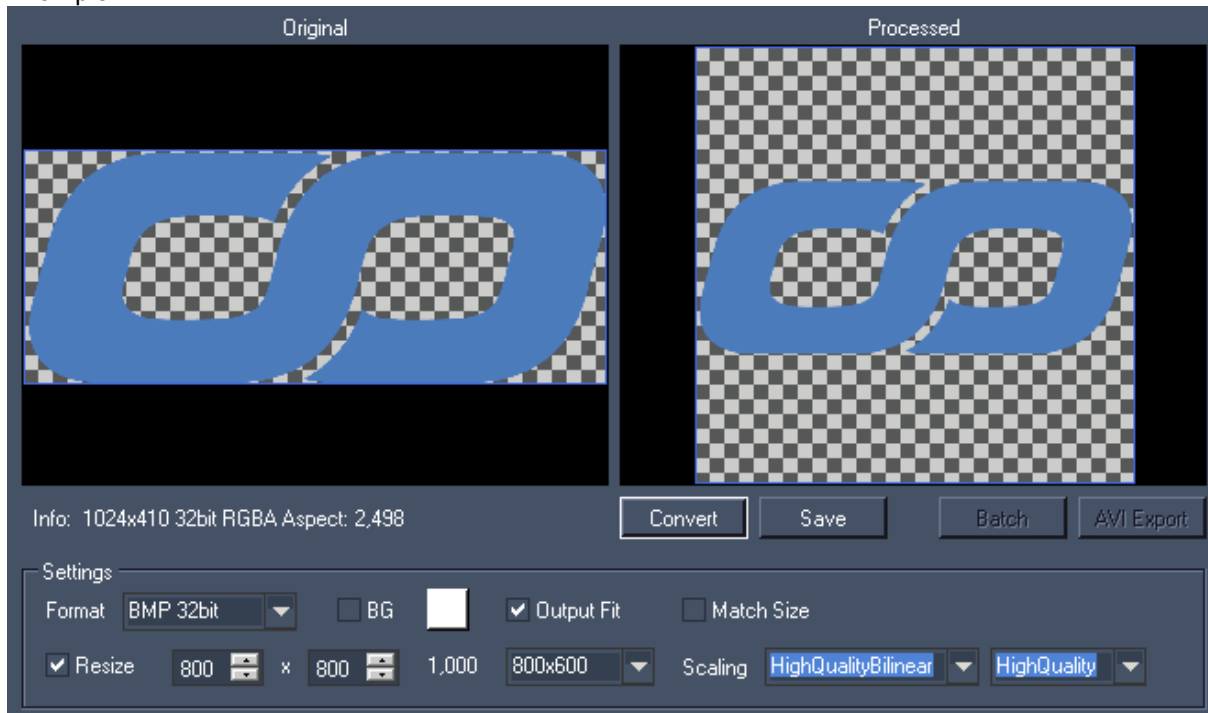

The logo (size 1024x410 px) is resized to 800x800 px, but this time the [Output Fit]-option is checked. The logo keeps its aspect ratio, only the canvas size's aspect ratio changed. The canvas area that is

added on top and bottom to fit to the output will appear transparent if [BG] is not checked. With [BG] checked it shows the chosen background colour.

[Scaling]:

Choose between several filtering and quality options for the scaling.

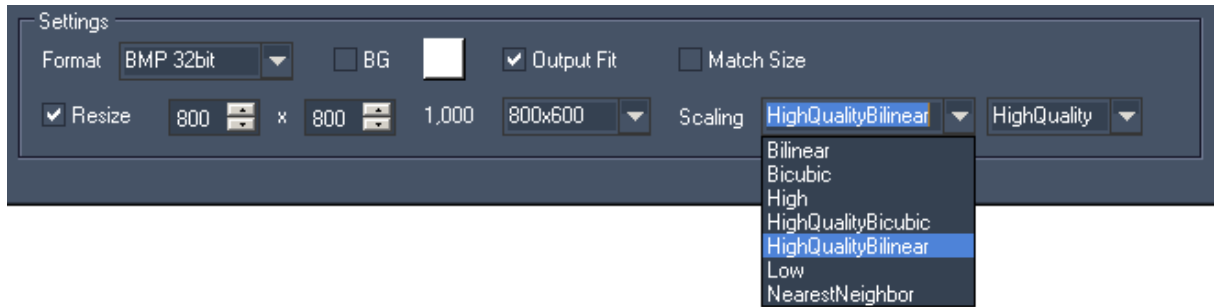

## 14 SPLITTER

The Splitter is designed for splitting one big master-file into several smaller split-files for Multi-Display or Multi-Projection purposes. This allows a good performance and capacity on the playback systems, with native playback of Video Content of nearly any size.

Features:

- Setup of any amount of Output regions
- Output Regions can wrap around top/bottom or left/right. This is important for 360° Panorama / Sphere content overlap setups

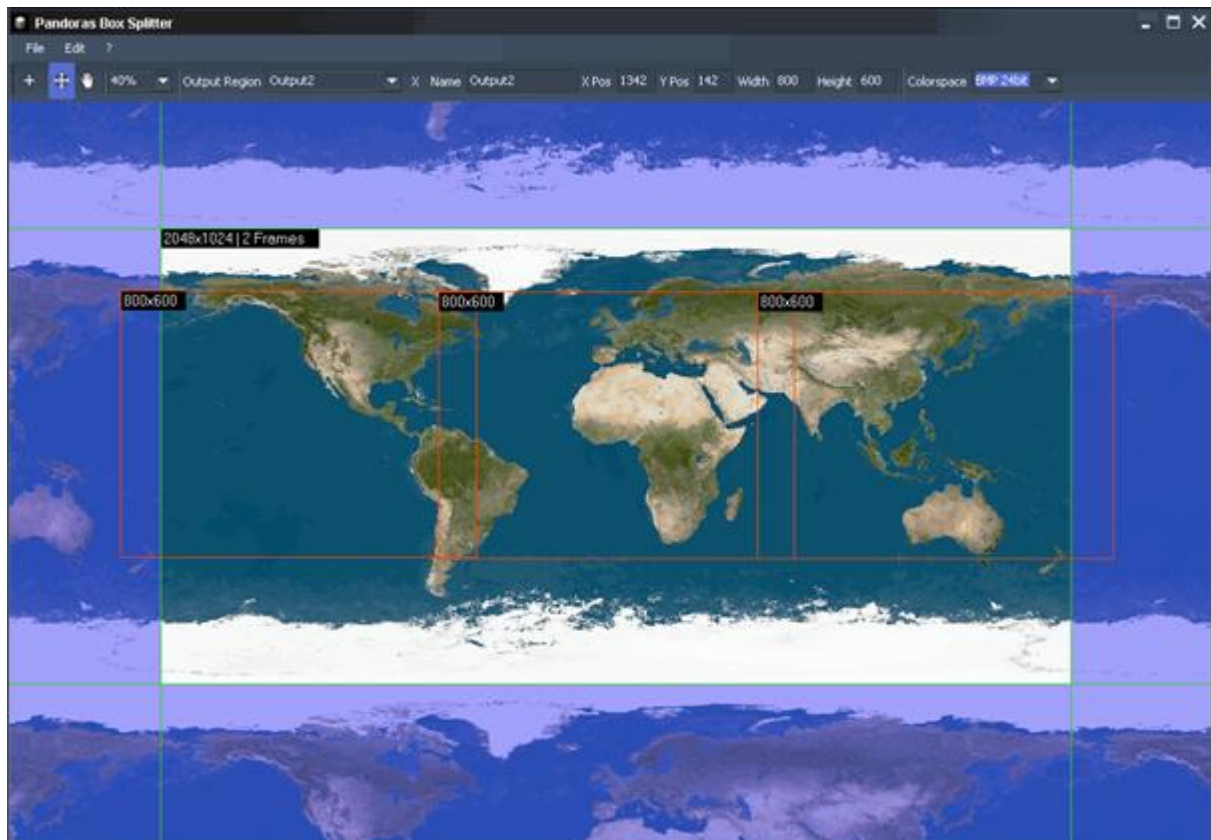

Using the Splitter primarily makes sense when the content has to be created before the technical setup is defined, e.g.. without knowing how many projectors will be used or how big the overlap between the projectors will be. This way the content producers may work independently from the technical setup. Only the total image resolution has to be defined.

Please note that it is only possible to load image sequences:

### Supported Input Formats:

- BMP Sequence
- JPEG Sequence
- TIFF Sequence
- TGA Sequence
- PNG Sequence

The advantage of using Image Sequences is that the data transfer will be considerably faster and allows an easier replacement of certain scenes inside a movie.



### Supported Video Sizes:

The Master Files may have 8192x2048 px (on Windows XP).

Under Win7 64bit files with up to 65535x2048 px may be processed.

See here more information about the [Splitter User Interface](#)<sup>849</sup> and the [Splitter Workflow](#)<sup>854</sup>.

## 14.1 SPLITTER USER INTERFACE

The User Interface is divided into the [File Menu](#)<sup>850</sup>, the [Edit Menu](#)<sup>851</sup>, the [Toolbar](#)<sup>851</sup> and the [Main Window](#)<sup>853</sup>.

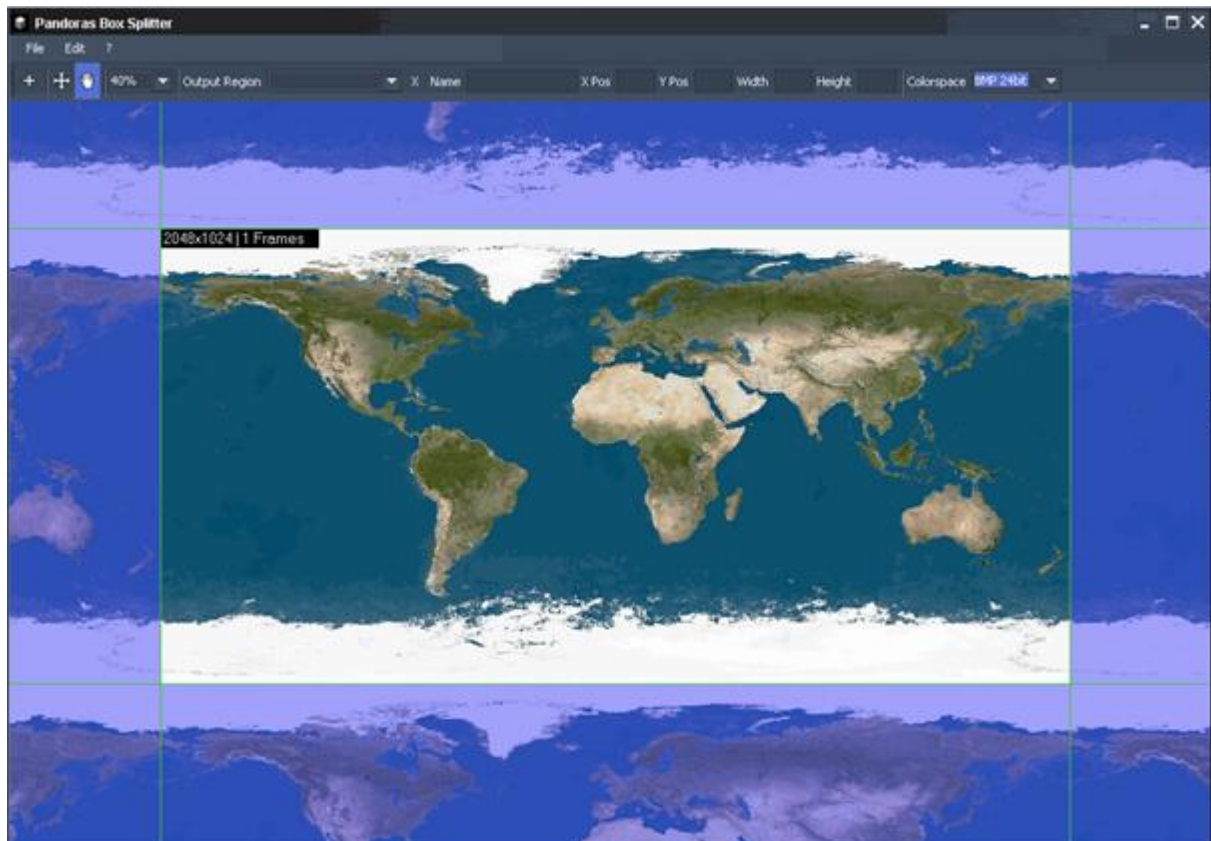

### 14.1.1 FILE MENU

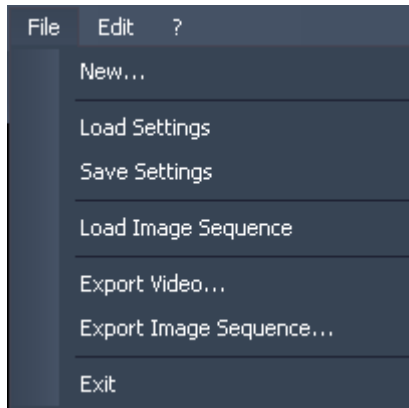

**[New...]**

All Output Regions will be removed and you may start loading a new image sequence.

**[Load Settings]**

You may load a Splitter project (.vsp) that you saved before.

**[Save Settings]**

You may save your current Splitter project as .vsp-file.

**[Load Image Sequence]**

Please browse to the folder your image sequence is located in. This will be loaded then into the current project.

**[Export Video...]**

Please browse first to the folder where you want to export your AVI video file to.

The upcoming AVI Export Settings dialog allows you to set the frame rate (24, 25, 30, 50 or 60 fps).

It displays as well the amount of frames.

Press [Start Export] to render out the video file.

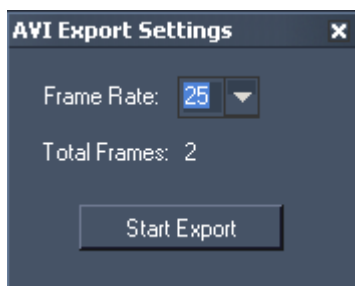

**[Export Image Sequence...]**

Please browse to the folder your image sequence should be exported to. When the export is finished you will be notified by a pop-up window.

**[Exit]**

Exits the application.

### 14.1.2 EDIT MENU

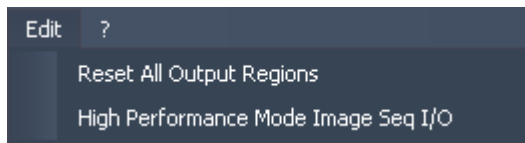

#### RESET ALL OUTPUT REGIONS

This option resets all output regions.

#### HIGH PERFORMANCE MODE IMAGE SEQ I/O

Using this option enables / disables the High Performance Mode for exporting Image Sequences.

#### OVERRIDE MPEG SIZE LIMITS

This option is of interest when working with still images, image sequences or avi. With the activated option "Override Mpeg Size Limits" you are free to set up any output region size.

According to the Mpeg specifications, the image width (in pixels) must be dividable by 16 and the height by 8. If you enter a region that does not conform to this specification, the Splitter corrects it automatically to the nearest smaller number allowed. For instance, a 33 pixel wide and 15 high region results in 32 x 8. If overriding the size limits, the output region can be 33 x 15. When using the Option in the File Menu to "Export Image Sequence + MPEG Video..." now, the exported MPEG file is being encoded without the specified settings and might cause unexpected issues when being played back.

### 14.1.3 TOOLBAR

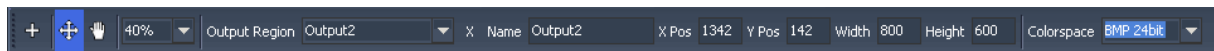

Use the toolbar to create and manage the Output Regions.



[ Create Region]:

Click the left mouse button and span the desired region.



[ Move Region]:

Select the desired region and move it to it's correct place.



[ Drag View]:

Use this mode to drag the view around.

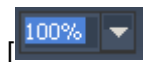

[ Zoom]:

Choose one of the Zoom factors to adjust the preview window. You may enter an individual zoom factor as well. You may use the keys + / - on your keyboard as well.

Output Region options:

Output Region	Output0	X	Name	Output0	X Pos	626	Y Pos	142	Width	800	Height	600
---------------	---------	---	------	---------	-------	-----	-------	-----	-------	-----	--------	-----

Output Region:

You may choose an Output Region from the list in order to delete it, to adjust its name, position or size.

[X]:

Press the cross to delete the selected Output Region.

[Name]:

To change the name of an Output Region, please select it first from the drop-down list, enter the new name and press [Enter].

[X / Y Pos]:

The Pixel values inside these two text fields display the position of the region's top left corner. To change its position to an exact place please enter new values for X and Y here.

To move a region with the mouse please use the option [Move Region], see above.

[Width / Height]:

These two values display the size of the selected Output Region. To change its size please enter the new Width and Height into the text fields.

Colorspace	BMP 24bit
------------	-----------

[Colorspace]:

Choose here the colorspace for the Image Sequence. You may choose between

- BMP 24bit (Bitmap, RGB)
- BMP 32bit (Bitmap, RGB + Alpha)
- PNG 32bit (PNG, RGB + Alpha)

This setting does not affect an exported AVI file, it will always be exported as Uncompressed AVI.

## 14.1.4 MAIN WINDOW

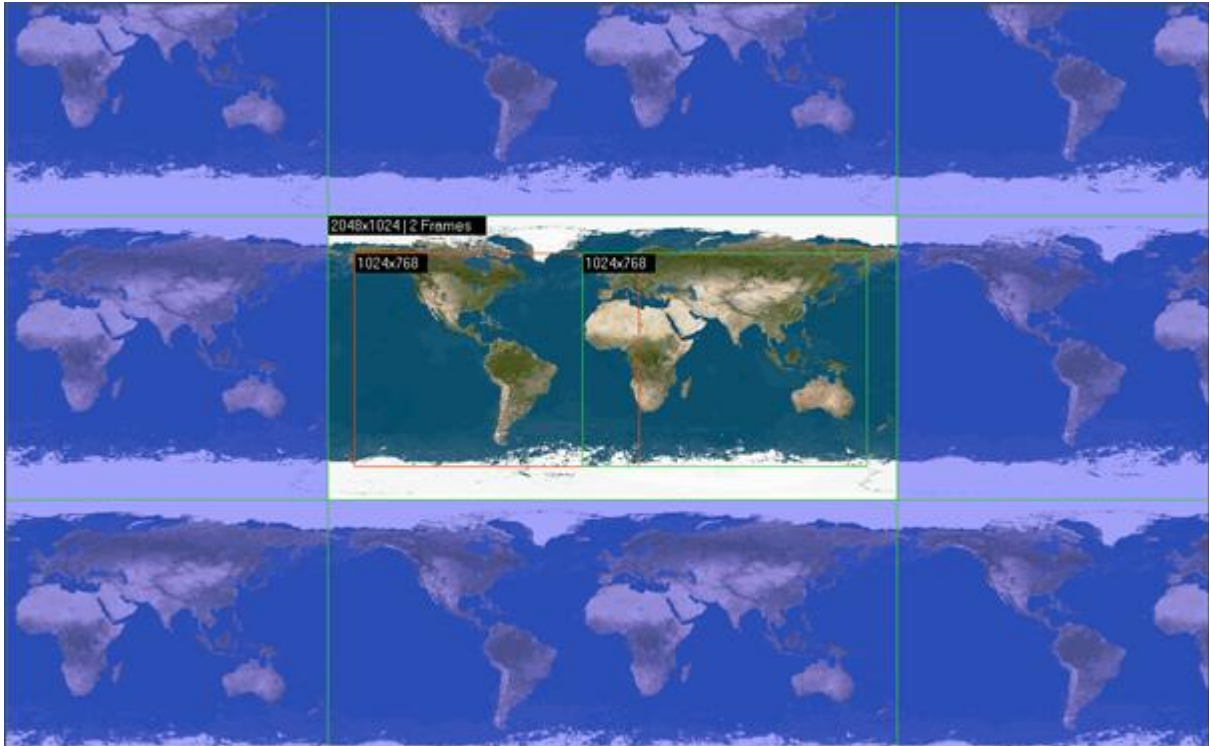

In the middle of the Main Window the loaded master file is shown, which is repeated at the left, top, right and bottom side. This allows you to wrap the Output Regions around top/bottom or left/right. This is important for 360° Panorama / Sphere content overlap setups.

You may set up any amount of Output Regions, using the right-click menu or the create mode (see [Toolbar](#)<sup>851</sup>). In the example above two Output Regions were created (green and red rectangle). Both have the size 1024x768 px. When exporting the master file, there will be a separate file created for each of the Output Regions.

The right-click menu inside the Main Window:

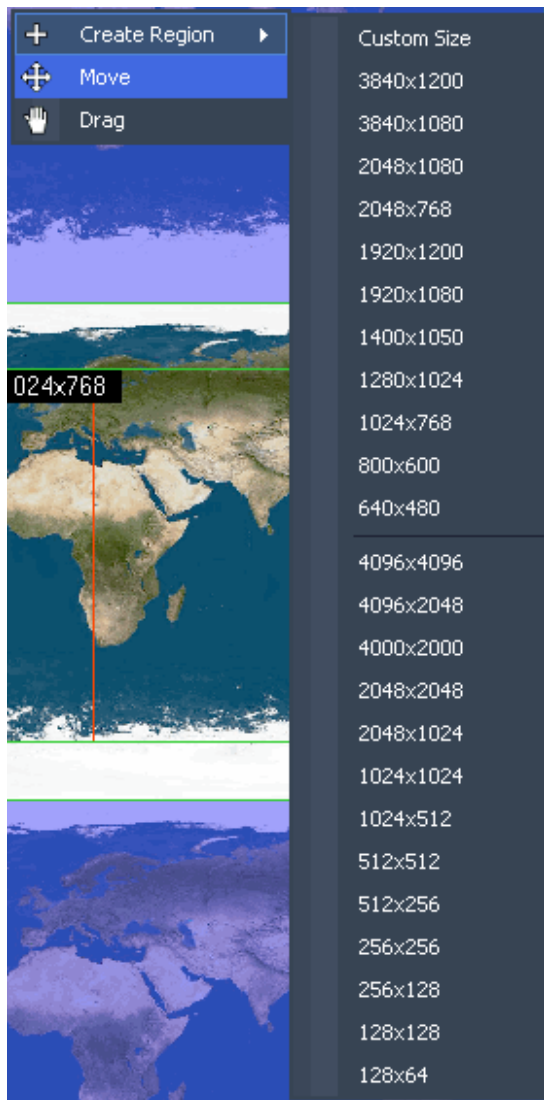

The right-click menu gives you access to

- Create an Output Region: Choosing Custom Size will enable you to span a rectangle in the Main Window. Choosing one of the pre-defined sizes you just have to define the position of the Output Regions top left corner by clicking into the Main Window.
- Move existing Output Regions.
- Drag the whole View around (incl. Masterfile and Output Regions).

## 14.2 SPLITTER WORKFLOW

To split a master file into separate split files, see here a short workflow overview:

1. Loading the master file:  
Load an Image Sequence or an existing Splitter Project using the File Menu.
2. Creating Output Regions:  
Create as many Output Regions as you need, using the “Create Region” function in the Toolbar or using the right-click menu inside the Main Window.

---

3. Adjusting Output Regions:

Probably the Output Regions need to be adjusted in their position and/or size. You may do this by moving the Output Regions with the mouse (using the "Move"-option from the toolbar). To do an exact positioning, select the Output Region (by name in the Toolbar or by clicking on it when being in Move-Mode) and enter the Pixel values of the top left corner in the Width and Height text fields.

4. Exporting the split files:

After the setup for the Output Regions is done you may export the separate split files now as Image Sequence or as AVI File. When exporting an Image Sequence choose the Image Sequence format in the Toolbar first (BMP 24bit, BMP 32bit or PNG 32bit).

5. Saving the current project:

Don't forget to save your settings in order to be able to modify the Output Regions after you once closed the Splitter. Do this inside the File Menu.

## 15 CITP DESKTOP STREAMER

The Pandoras Box CITP based Desktop Streamer is a versatile tool to stream any Windows XP / Win7 desktop region, for example the preview section of Pandoras Box Manager or any application content, into WYSIWYG or Capture Polar directly.

This way you can project your favorite video content directly into WYSIWYG without using any capture cards. It is designed for pre-programming and can also be set up at different frame-rates to match the systems performance.

You may use several instances of the Desktop Streamer at the same time!

Please note that StreamiX Desktop (since V5.1) - a TCP based Desktop Streamer that works as a Live Input in Pandoras Box - is described [here](#)<sup>650</sup>.

### 15.1 CITP DESKTOP STREAMER USER INTERFACE



The User Interface is divided into three sections: the [Streaming settings](#)<sup>856</sup>, the [Preview Window](#)<sup>857</sup> and the [Capture Settings](#)<sup>858</sup>.

#### 15.1.1 STREAMING SETTINGS

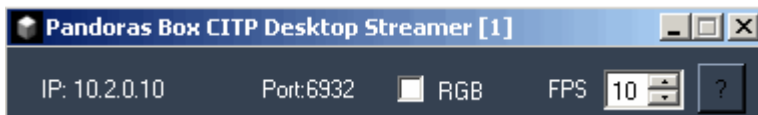

[Window Title]:

You may start several instances of the Desktop Streamer at the same time to pass several CITP streams into your WYSIWYG application. The number shown in the Window Title [] displays the stream number: Pandoras Box CITP Desktop Streamer [1] = Stream 1.



[IP / Port]:

On the top left the computer's IP address and the used TCP/IP-Port are displayed.

[RGB]:

The [RGB] option allows you to match to the C1TP colour space of your WYSIWYG version.

If this option is disabled, the colour space BGR is used for C1TP streaming. Enable it and the colour space will be changed to RGB.

Background:

Up to WYSIWYG Rev.25 the colour space BGR (according to C1TP 1.0) is used.

Up from WYSIWYG Rev. 26 the colour space RGB (according to C1TP 1.2) is used.

[FPS]:

The Framerate can be set to values between 1 and 30 fps, according to your system's performance. Please note: you don't have to press [Apply], your changes are applied immediately.

[?]:

See here information about the settings you will need in WYSIWYG in order to use the C1TP stream, see [WYSIWYG settings](#) <sup>859</sup>.

### 15.1.2 PREVIEW

The Preview shows the part of your desktop that is sent via C1TP.

According to the C1TP specifications the size of the streamed media is 144x144 px.

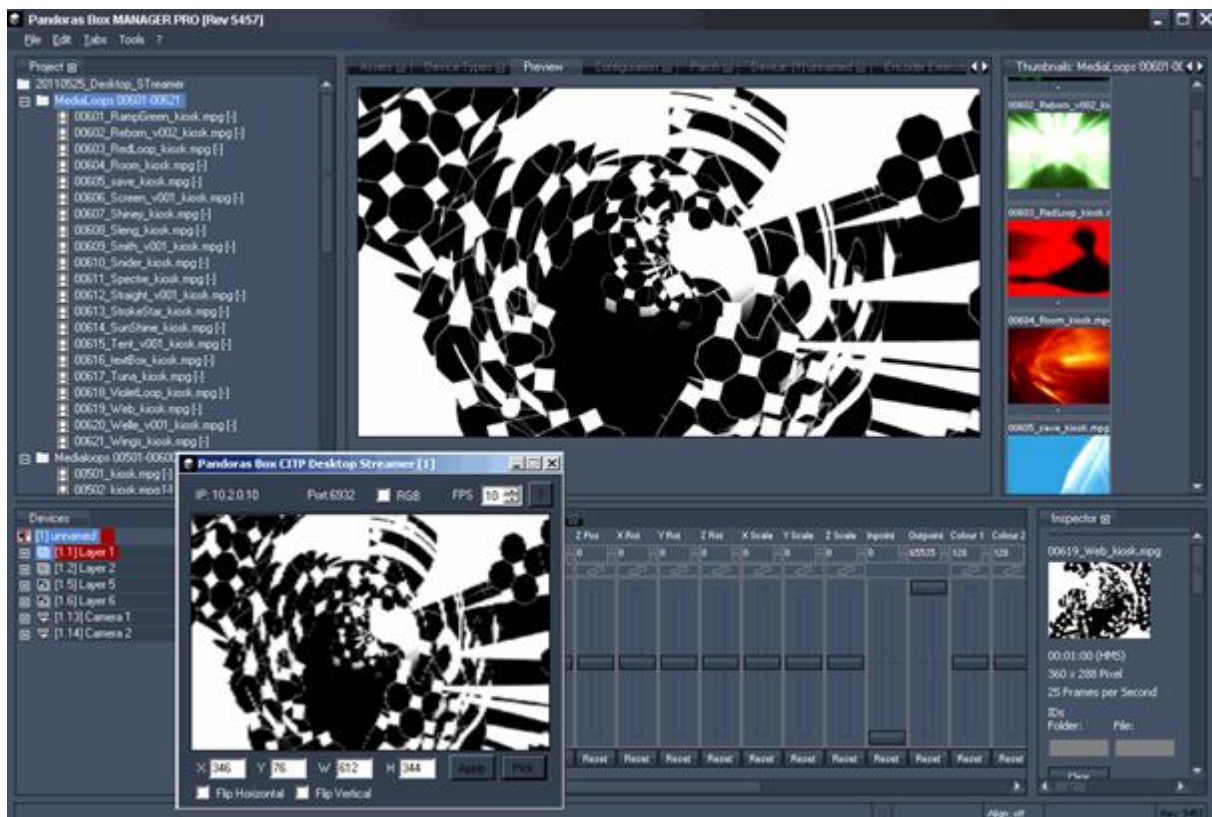

Example:

In the image above the Pandoras Box Preview window is streamed via the Desktop Streamer.

Please note:

The Preview will not show modifications like image flipping or a change in the colour space. This will be seen in WYSIWYG only.

### 15.1.3 CAPTURE SETTINGS



[Defining the capture region]:

There are two possibilities to define the region of your desktop that is going to be captured for CITP streaming:

1. enter the region's width and height (W/H) as well as its starting pixel (X/Y) into the text fields and press [Apply].
2. press [Pick] and span the desired desktop region with the mouse.

Please note:

To capture a desktop region that is on a secondary monitor, enter the region's Width, Height and starting pixel as described in option 1. This can't be done by picking a region with the mouse.

[Flip Horizontal / Flip Vertical]:

Depending on the texture mapping in WYSIWYG, these two options offer you to flip the CITP stream horizontally and / or vertically.

Please note:

You don't have to press [Apply], your changes are applied immediately.

### 15.2 CAPTURE POLAR SETTINGS

In order to stream your desktop or parts of it over to Capture Polar, please follow these steps:

- Start Capture Polar.
- Open a new or existing project.
- Start the Pandoras Box Desktop Streamer.
- Go to the Video Tab.
- The COOLUX Pandoras Box stream should be displayed in the list.

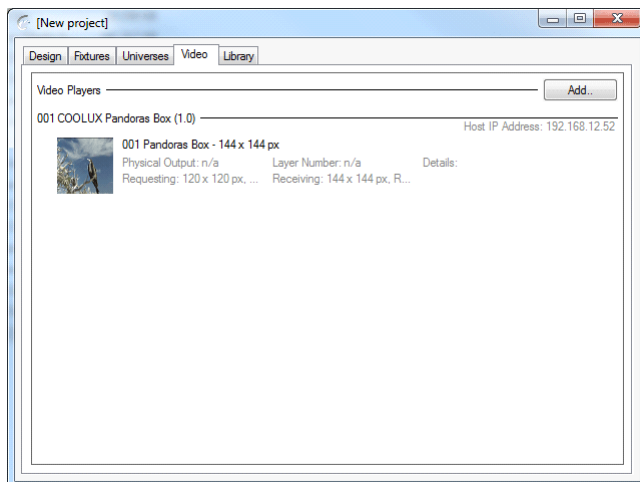

- Go to the Design tab.
- In Materials you add a new material".
- Select the Coolux Pandoras Box stream, in the right window next to Video.
- Add this material as a texture to the desired objects.
- The Video Stream can be stretched manually or automatic to one or more objects.



### 15.3 WYSIWYG SETTINGS

In order to stream your desktop or parts of it over to WYSIWYG, please follow these steps:

- Start WYSIWYG.
- Go to "Options - Application Options" tab "Additional Interfaces" and check "Enable CITP".
- Close and restart WYSIWYG.
- Within a project open the Video Manager.  
(this can be found in the menus Tools/Design/Live depending on your Working-Mode).
- Add a new video source.
- Check "CITP Video Stream" and click browse.
- Select the COOLUX Pandoras Box stream from the device list.
- Assign the stream as a texture to the desired objects.
- Open the "Video Tool" from "Live/Design".
- Select the CITP stream from the drop-down list and click the play-button.

## 16 VNC REMOTE

The PB VNC Remote application lets you scan the network for PB devices and to remote-control them.

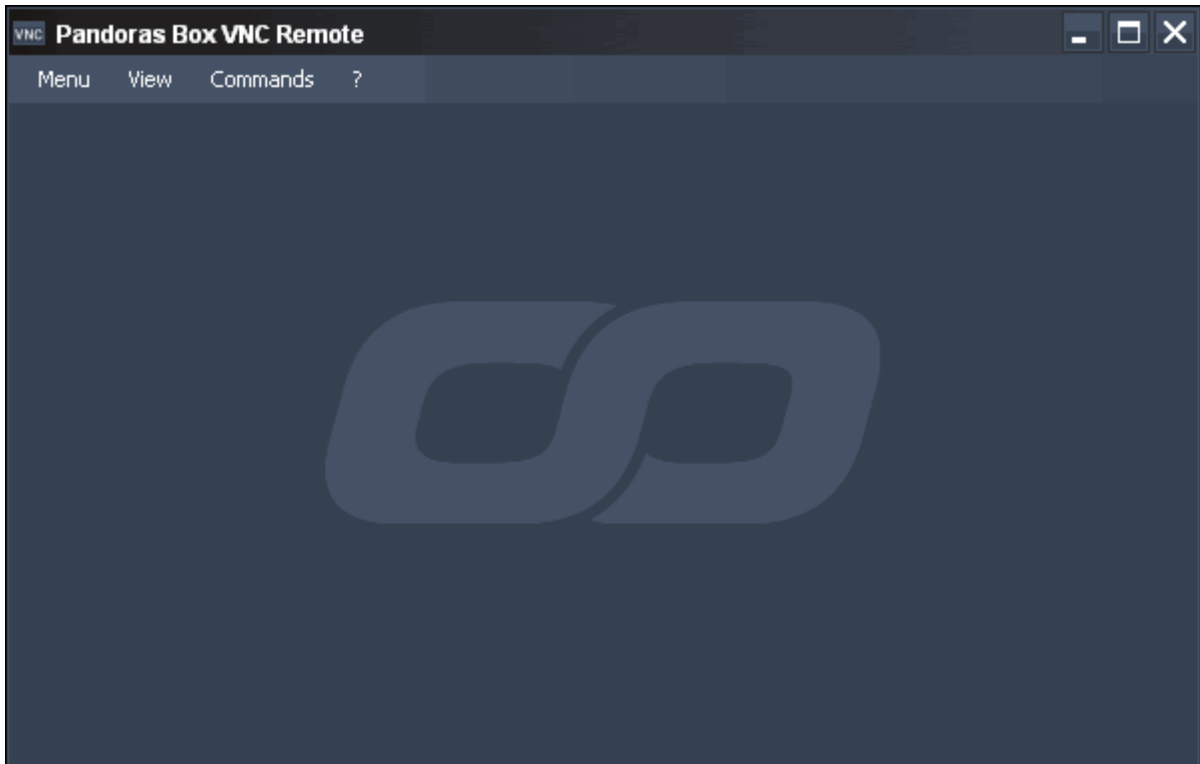

Pressing MENU in the menu bar allows you to:

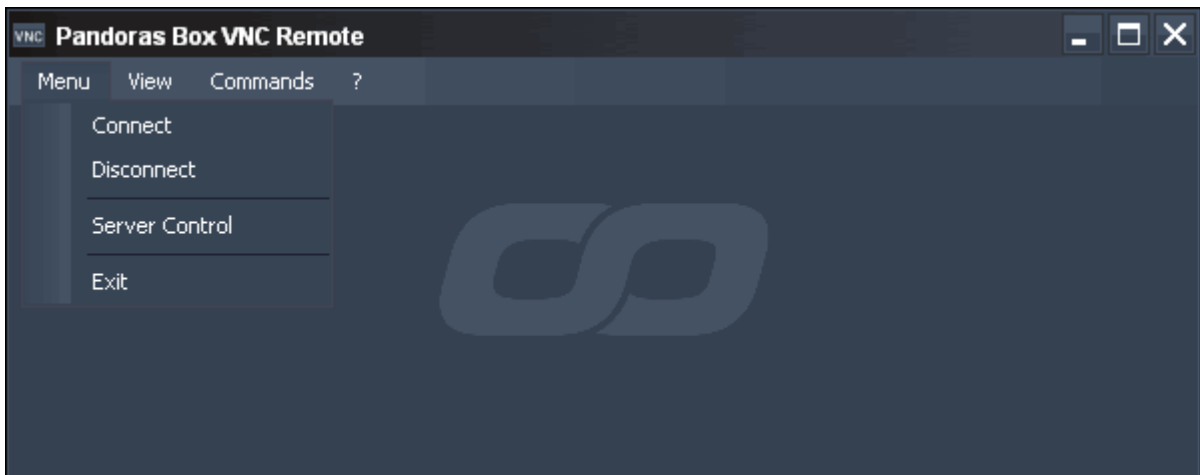

CONNECT to a VNC Server

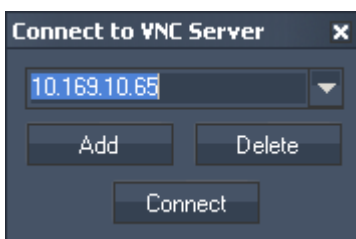

Enter the server's IP address or name.  
To add this server to the drop down list, press ADD.  
To delete it from the list, press DELETE.  
To connect to the server, press CONNECT.

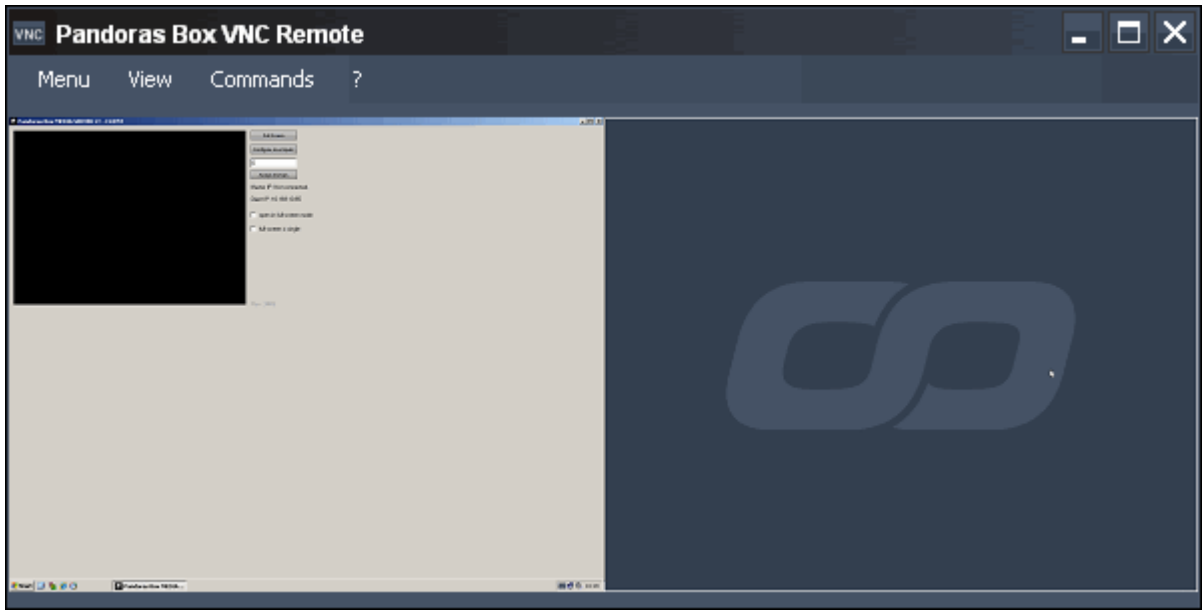

**DISCONNECT**

The connection to the VNC server will be stopped by pressing this button.

**SERVER CONTROL**

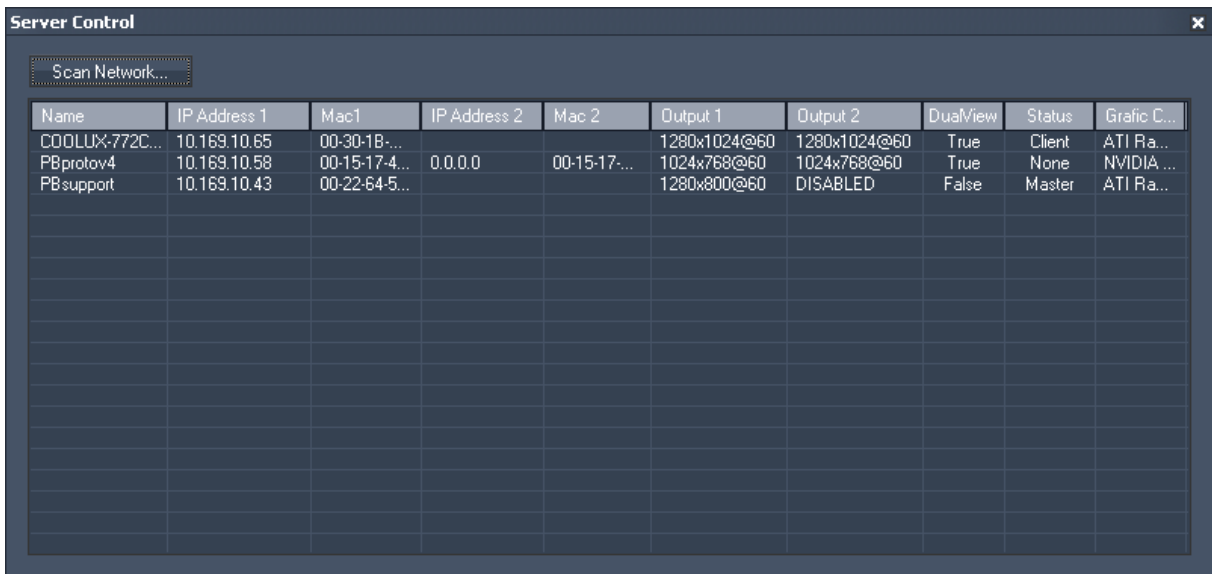

Press SCAN NETWORK and you will get a list of all PB devices running the Onscreen Menu Rev. 32 or higher.

The list contains information about:

- the server's name
- IP and Mac Address 1 (and 2 if existing)
- the resolution of Output 1 and 2
- the graphic card's desktop setup
- the status of running PB software (Master, Client or None)
- the server's graphics card

Selecting one of the servers and right-clicking lets you control this device.

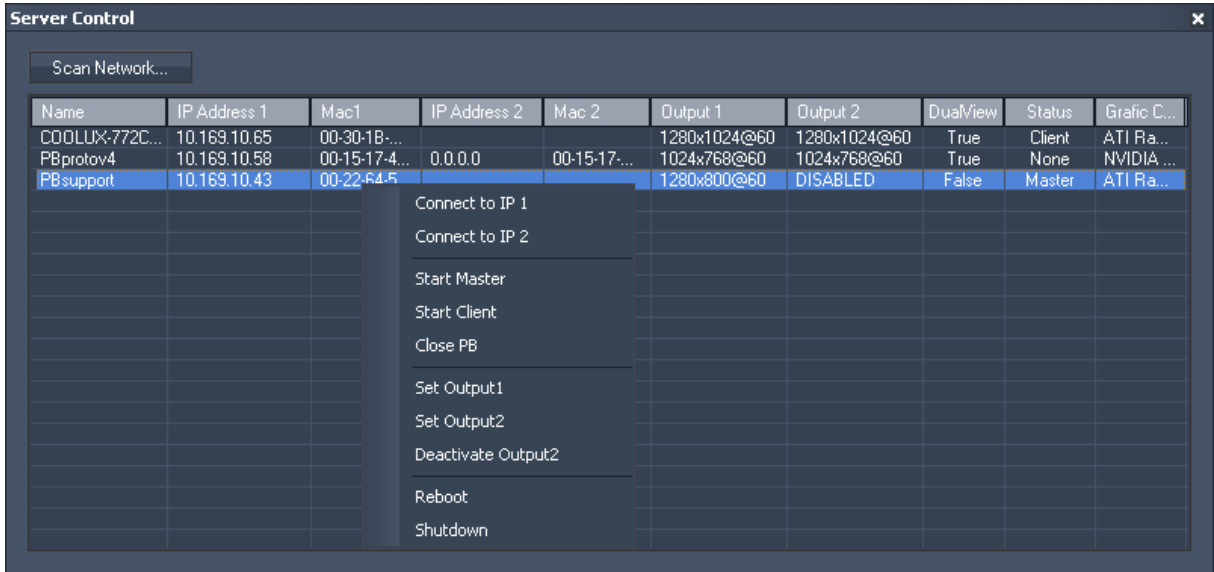

You can either connect to IP 1 or IP 2, start the PB Master or Client or close the PB application.

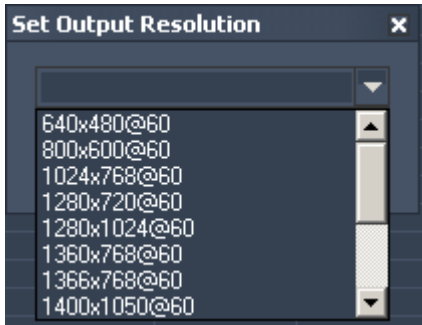

You may set different output resolutions for Output 1 and 2. Just choose the supported output resolution from the drop down list.

You may deactivate Output 2.

Please note: Only Nvidia graphic cards are supported.

The Reboot and Shutdown commands are also available.

EXT

Close the VNC Remote Application by pressing EXT.

Pressing VIEW in the menu bar allows you to:

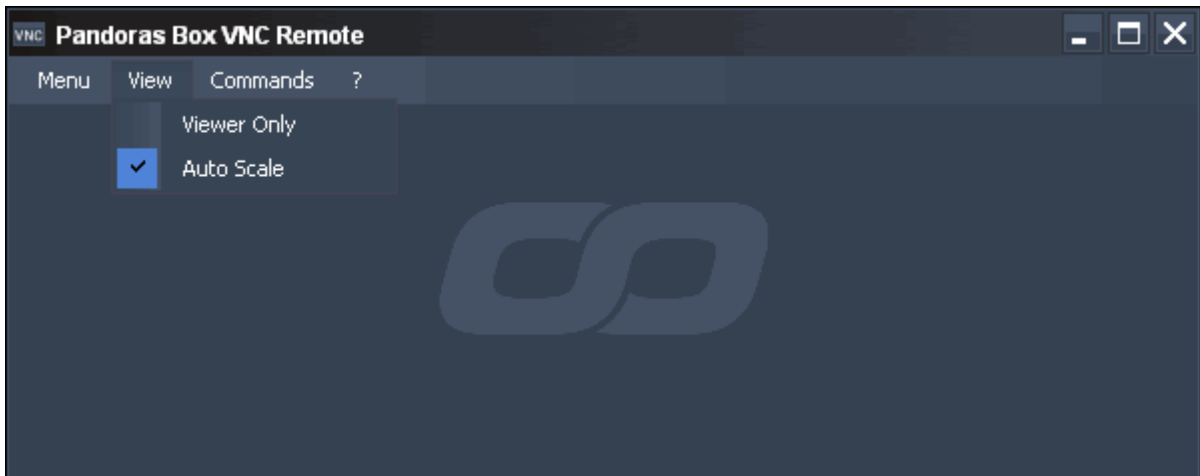

**VIEWER ONLY**

If this option is checked, the VNC Remote tool works as viewer only. You will not be able to manage the connected server.

**AUTO SCALE**

This option is checked by default, it will automatically scale the viewed desktop into the VNC Remote window.

Without Auto Scale you will get a 1:1 resolution.

Pressing Commands in the menu bar allows you to:

- control the Pandoras Box application:

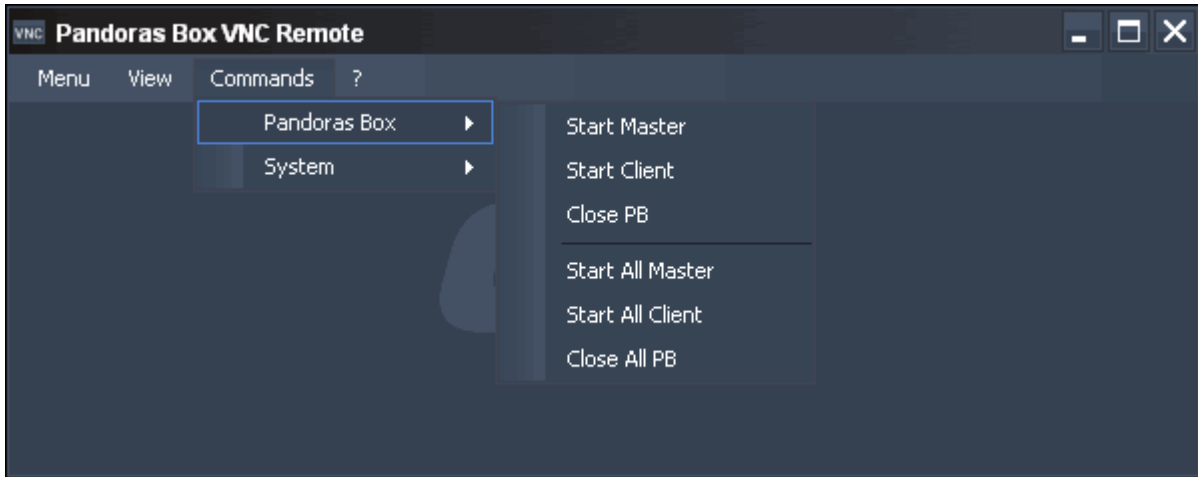

Start Master, Start Client or Close PB on your local machine.

Start All Masters, All Clients or Close All PB on all machines in the network running the onscreen menu Rev. 32 or higher.

- control the system:

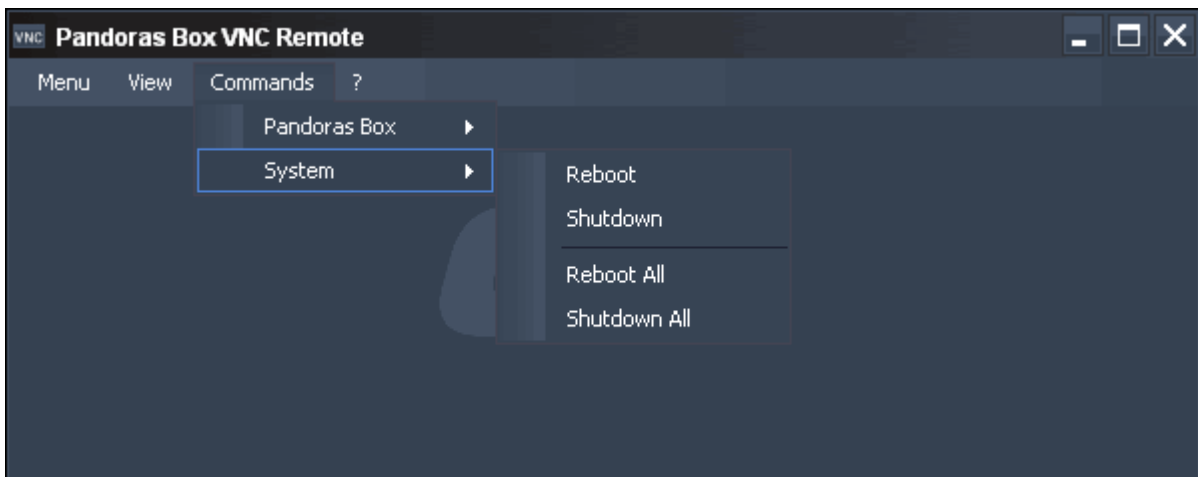

Reboot or Shutdown the local machine.

Reboot or Shutdown All machines in the network running the onscreen menu Rev. 32 or higher.

## 17 WIDGET DESIGNER

The main purpose of Widget Designer is to provide a graphical user interface design and runtime environment. With Widget Designer you can create user-controls such as faders, buttons, labels and many more and instantly use them without compiling any code.

Widget Designer has been created for users that do not need to have any programming skills to create their own custom applications or interfaces.

While WD is based on the Microsoft .net framework all controls have been designed to meet the requirements of flexible and dynamic programming.

One of the most powerful concepts in WD is the [script language](#)<sup>1254</sup>. Anywhere in WD where commands can be entered you may access all commands from a list box to copy and paste the desired command into your control.

Currently over [1000 commands](#)<sup>1260</sup> are available to control specific features of Pandoras Box, Widget Designer or other 3rd party products and protocols.

The Widget Designer comes in three versions :

### Widget Designer Standard

The WD STD is provided as a freeware license and can be [downloaded](#) on the official coolux website. It allows you to create custom user interfaces and to work with commands.

Using the build-in [Web Server](#)<sup>1177</sup> you may publish one page to be accessed by one user.

You may open a project that was originally programmed with a PRO or ULT environment. All elements that are part of the STD license will be displayed and will run in the dedicated way. If PRO / ULT features were used that are marked in the user interface as "PRO only" or "ULT only" you will get a message that these elements are not available in the STD version. Other features, like [nodes](#)<sup>959</sup> or [variables](#)<sup>1193</sup> for example still exist even though they are not part of the STD package. Please note that a STD version can run but not change the settings of those features. Only a PRO or ULT version provide full editing access.

When you are looking for a version that cannot be changed at all by the end customer, the Widget Viewer is the tool of choice. The **Widget Viewer** comes with the STD, PRO and ULT installation, thus only the STD Viewer can run without an attached dongle.

In the Viewer Mode the Run Mode works without restriction. The Edit Mode is not possible, i.e. GUI elements cannot be repositioned etc. In addition, the right-click menu as well as the [Menu Bar](#)<sup>869</sup> only allow to load a new WD File, i.e. saving (under old or new name) and opening Item Properties is not possible.

### Widget Designer Professional

WD PRO offers various advanced features and tools to give you the most flexible and easy way of programming user interfaces and interactive show elements. The PRO version allows to program visually with so called nodes. By simply connecting those visual control components you may create a dedicated interaction logic.

Using the build-in [Web Server](#)<sup>1177</sup> you may publish one page to be accessed by several users at the same time whereas the sessions are all synchronized.

### Widget Designer Ultimate

WD ULT offers the same number of tools as the PRO version. For certain features it offers even more professional settings.

Using the build-in [Web Server](#)<sup>1177</sup> you may publish an unlimited number of pages to be accessed by several users at the same time. In addition you may decide whether the users see a synchronized interface of an individual one. Thus the ULT version suits your needs when working in large multi-user projects that focus on the integrated Web Server.

The ULT version offers to choose a dedicated network adapter for various protocols. That means that you



may send Art-Net data via NIC1 whilst Pandoras Box show control data uses NIC2. In addition, the ULT license comes with more advanced MIDI options as well as the support of multiple [AirScans](#)<sup>1155</sup>.

Please see the following topics for working with the Widget Designer:

[Setup](#)<sup>865</sup>

[User Interface](#)<sup>869</sup>

[Controls \(Create Menu\)](#)<sup>879</sup>

[Nodes](#)<sup>959</sup>

[Tools Menu](#)<sup>1154</sup>

[Script Language](#)<sup>1254</sup>

## 17.1 SETUP

The following two chapters explain how to setup and get started with Widget Designer. Whilst [Installation and Launching](#)<sup>865</sup> helps you with the very first steps, [Network Setup](#)<sup>865</sup> enlightens the settings when using WD to receive and send data to Pandoras Box.

### 17.1.1 INSTALLATION AND LAUNCHING

All WD versions require Microsoft .net framework and the latest DirectX 9c to be installed prior to the installation of WD.

If you have any issues with the installer itself you may need to update your windows installer from the Microsoft homepage. As well we recommend to use the newest dongle driver version when installing the software WD PRO or ULT.

WD STD and its Viewer do not require any dongle, neither for the installation nor for running the software.

Once WD is installed on your PC you may launch WD from the start menu or create a shortcut on your desktop. Double-clicking a project (i.e. project.wdp) will always launch the last installed Widget Designer version.

### 17.1.2 IP CONFIGURATION (NETWORK SETUP)

Depending on how you want to use and integrate Widget Designer (WD) to control Pandoras Box (PB) or other devices, the first thing you might want to set up is the network communication. When working in a network environment you need to make sure that the IP address, domain and port are correct otherwise you might not be able to send or receive control data.

To access the network configuration dialog click "View" > "IP Configuration" in the menu bar, alternatively right-click anywhere on the empty main background window and choose the command in the context menu.

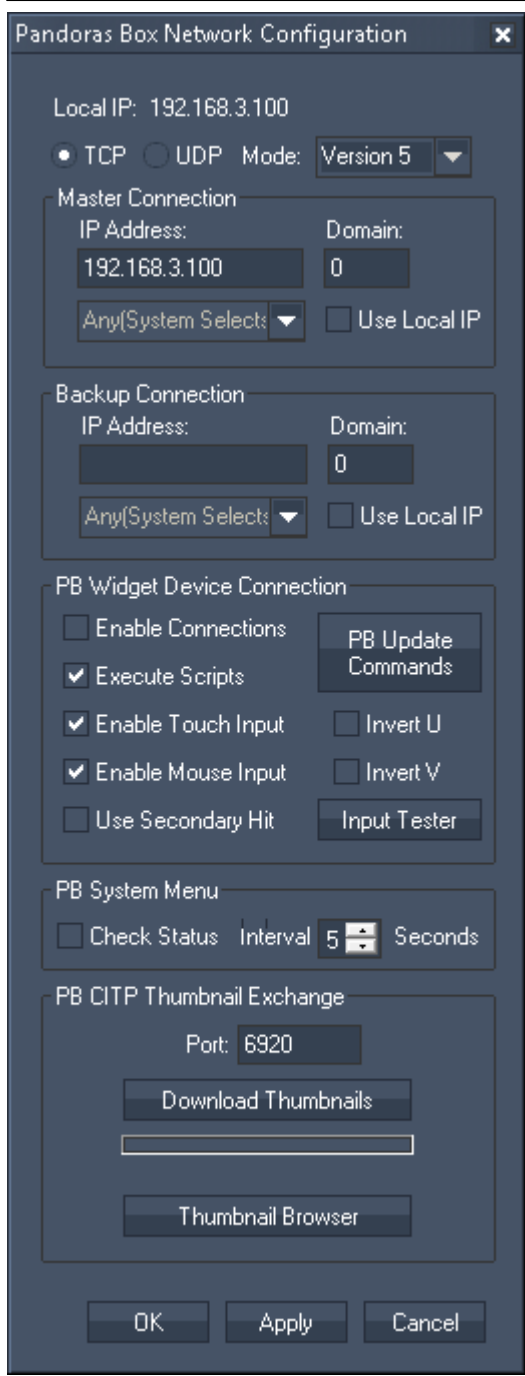

In the top section the local IP address is displayed. When the PC is not connected to a network, the local IP is 127.0.0.1. If you make any changes in the network adapter please save your project settings and restart Widget Designer.

The next options are needed if WD should communicate with a PB system. If you are running WD on the same computer with the PB Master system that you would like to control, all that needs to match are the version in the drop-down list and the domain setting. Per default the domain is 0, if it is changed it can be found in the [Configuration Tab](#)<sup>139</sup> of Pandoras Box.

TCP / UDP

The connection to Pandoras Box may be set up via TCP or UDP. The ports that are used are 6211 for TCP and 6212 for UDP.

TCP: this connection is bi-directional, it enables you to receive feedback messages from Pandoras Box besides sending commands only.

UDP: this connection is uni-directional. You will only be able to send commands to Pandoras Box without getting any feedback messages.

PB

Please choose here the version of the Pandoras Box Master Device (Version 5 or Version 4.7). This setting is very important, as from PB Version 5 on the value ranges changed completely. When choosing a 4.7 version please note that only Rev 5771 or higher are supported. When working with an older PB version please downgrade Widget Designer to Revision 178 or lower.

Pandoras Box Master Connection

If you would like to connect to Pandoras Box Master please enter the IP and domain of the Pandoras Box Master Device here.

In case your systems use multiple network adapters simultaneously please always check the IP address in the [asset browser tab](#)<sup>137</sup> of Pandoras Box to get the right IP address of the network adapter in use.

When using a Widget Designer ULT edition you may define a dedicated network adapter used for transmitting this protocol. For more information about multiple network adapters please see the chapter [Connection Manager](#)<sup>1166</sup>.

Pandoras Box Backup Connection

The network configuration dialog also allows you to set up a backup IP and domain. This setting is used

when your Pandoras Box system is set up as full redundant backup with two Master systems. If you wish to send all Pandoras Box related controls to both the Master and backup system then enter all fields here.

#### Pandoras Box Widget Device Connection

The device type "Widget Designer" in Pandoras Box allows to execute commands directly from its timeline in a very convenient workflow. Commands can be stored within keys. In addition to that, trigger values can be sent to the Widget Designer application. Furthermore, mouse and touch data from the PB Master or Client can be forwarded to Widget Designer either in total screen resolution or interpreted in UV data.

The check box "Enable Connections" allows Widget Designer Devices in Pandoras Box to connect to this WD application via TCP port 6213. "Execute Scripts" allow that commands programmed into a timeline key within the Widget Designer Device can be executed by this WD application. The button "PB Update Commands" updates the available commands in PB's drop-down list, e.g. if you are using an older PB version or newer WD version.

The topic "[Widget Designer Device](#)<sup>609</sup>" explains the workflow in more detail.

"Enable Touch" and "Enable Mouse" allow touch and mouse inputs to be transmitted. This is explained in more detail in the PB chapter about [Layer Picking](#)<sup>244</sup>. The button "Input Tester" shows incoming data with following allocation: Action, IP address, Site and Device, TouchID, (Screen resolution in pixel) X and Y, (Texture coordinates in vector size) U and V.

The Site and Device ID relate to the layer that is "touched" by the touch point or mouse cursor, depending on the [Input Event settings](#)<sup>207</sup> of the Site in PB, i.e. whether "Route to Layers" is checked. In special applications, there might be an overlaying, foreground layer with different texture coordinates. In that case you want to disregard this first layer but route the touch / mouse input to one layer further done. This is achieved by clicking the check box "Use secondary hit" in Widget Designer.

For inverting the texture coordinates (from 0→1 to 1→0) choose the according "Invert U" and / or "Invert V" option.

#### PB System Menu

Some [nodes](#)<sup>959</sup> in WD (e.g. Nodes > Input > Pandoras Box > System Menu (or search for PB Menu) connect to the [PB System Menu](#)<sup>754</sup> and receive status information. Click the check box to enable the connection and choose how often it is updated.

#### CITP Thumbnails Exchange

Up from V4.5 of Pandoras Box you may want to download the media thumbnails for later use in button controls.

The thumbnail exchange is provided via the CITP thumbnail exchange of Pandoras Box. Before downloading any thumbnail please first activate the [CITP mode in Pandoras Box configuration tab](#)<sup>146</sup> and make sure that the IP domain and port matches and is applied in WD.

Please keep in mind that CITP is transmitting only indexed media. This means that any media that you would like to download needs to have a [Folder and File ID](#)<sup>190</sup> assigned in Pandoras Box. Once this is set up you may press [Download Thumbnails] and once the blue progress bar is completed, all thumbnails of Pandoras Box will appear.

To get an overview of the downloaded images you may click on [Thumbnail Browser] to check if all files were successfully received and stored into WD file structure.

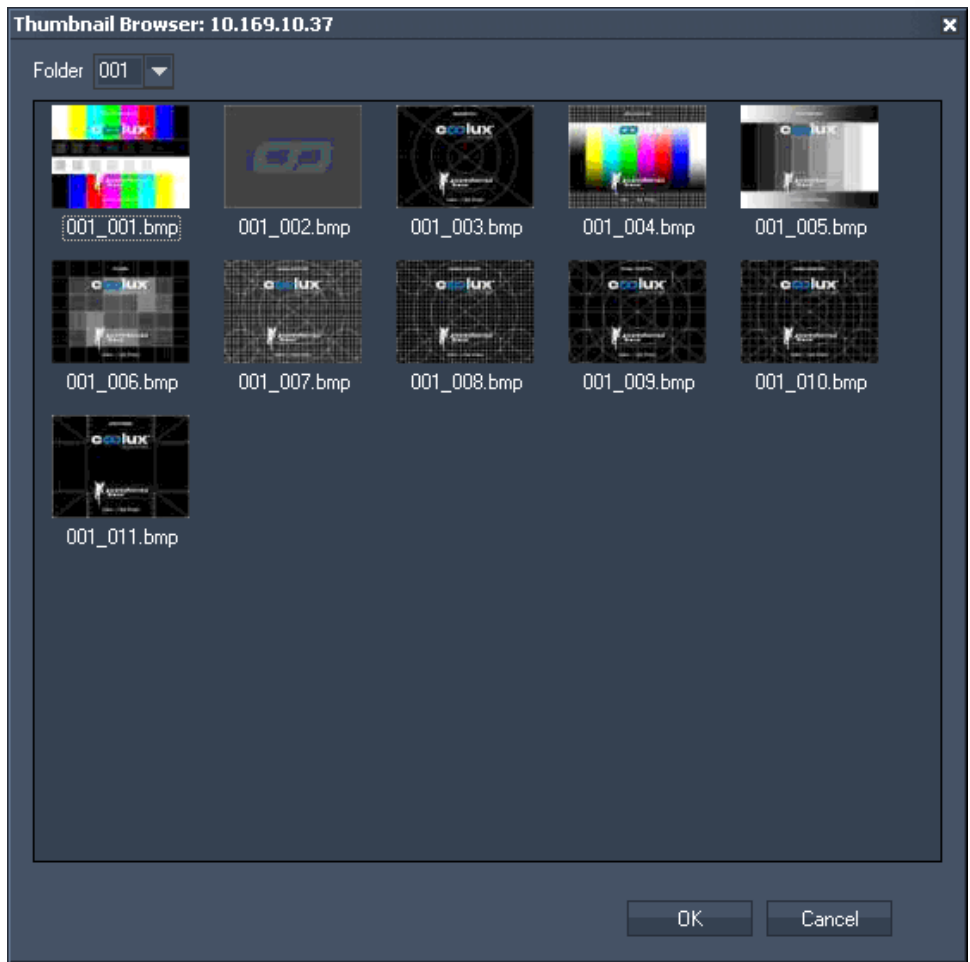

Please be aware that all thumbnails are stored into the WD file structure based on the given source IP address. Once you change the IP address of Pandoras Box you will have to download the files again in order to have WD find them on the local hard drive system.

Network Broadcasting Service

This section has been moved to the [Remote](#)<sup>1182</sup> dialog > [Network Broadcasting Service](#)<sup>1184</sup>

## 17.2 USER INTERFACE

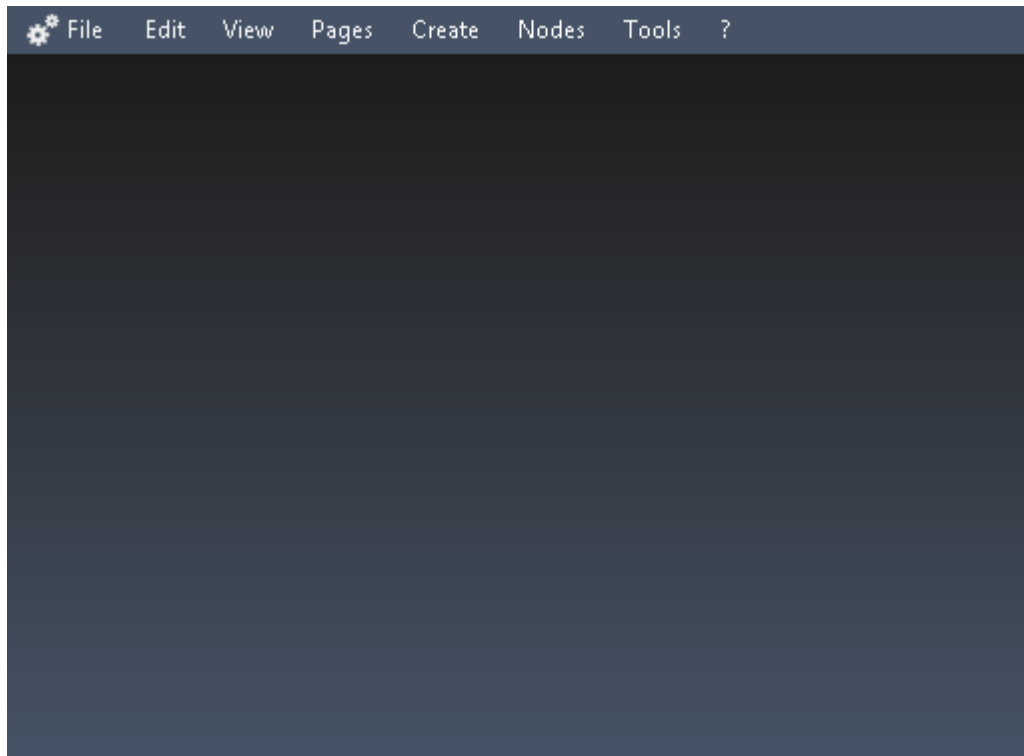

When starting WD you will see an empty screen with a main menu bar. The empty screen represents the main background of your application window. A right-click here opens a context menu that offers ALL options from the main toolbar as well.

Please see the following topics for detailed description regarding the menus:

[File](#)<sup>872</sup>

[Edit](#)<sup>873</sup>

[View](#)<sup>875</sup>

[Pages](#)<sup>876</sup>

[Create](#)<sup>877</sup>

[Nodes](#)<sup>877</sup>

[Tools](#)<sup>1154</sup>

In the topic [Main GUI Properties](#)<sup>870</sup> you learn how to influence the general project settings and style of the main application window. The last topic within this chapter lists all available [keyboard shortcuts](#)<sup>878</sup>.

You may wonder why you do not see any standard windows borders and their controls to close, maximize or minimize the application.

The reason why these features are disabled by default is that WD is mostly used for touch screen interface design thus we like to offer the biggest and cleanest area possible to work with. You may change that default setting within the [Main GUI Properties](#)<sup>870</sup> or the [file menu](#)<sup>872</sup>. To access the border quickly press [CTRL+SHIFT+T].

## 17.2.1 MAIN GUI PROPERTIES

The main background window represents the Main GUI window. The general project settings and style of the main application window can be influenced by right-clicking anywhere into the empty background and going to "Item Properties". The Main GUI properties dialog opens.

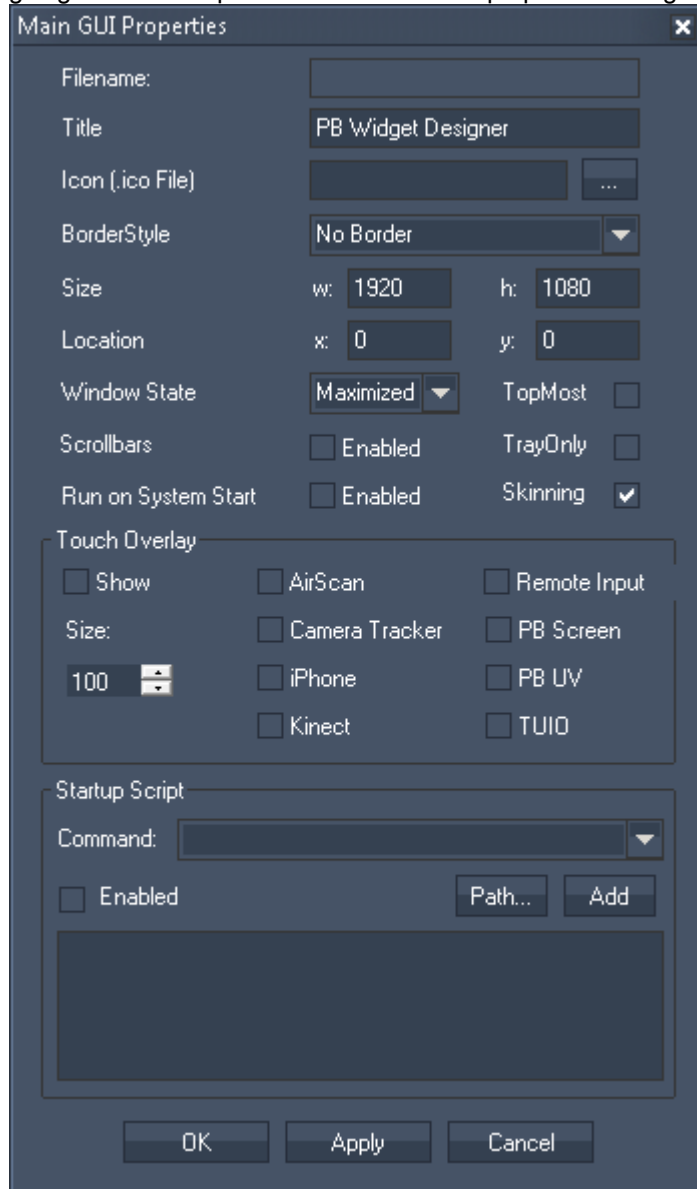

**Filename:**

As soon as you saved your Project under a file name, it will be displayed here.

**Title:**

This title is shown when using the BorderStyle Icon Title Window or No Icon Tool Window.

**Icon (.ico File):**

If you want to display an icon in the Title Window different from the default WD Icon, press [...] and browse to your file.

**BorderStyle:**

Depending on the BorderStyle chosen you may or may not see a standard Windows border and application title bar.

You may as well use the shortcuts:

[CTRL+SHIFT+T] = Show Main GUI Title Bar

[CTRL+SHIFT+F] = Hide Main GUI Title Bar

### Size:

Define the size of the WD Interface by entering the width (w) and height (h) in pixels.

### Location:

By default the WD Interface will start in the top left corner of your screen. You may change the window's location here by entering the starting pixel (x and y).

Another way to start the WD in one of the screen quadrants (top left = Q1, top right = Q2, lower left = Q3, lower right = Q4):

Create a shortcut of the Widget Designer .exe file (for example on your desktop). Right-click on this shortcut > Properties. On the tab "Shortcut" attach Q3 to the Target text field (with a space in between), so that it for example looks like this: "C:\Program Files (x86)\coolux\WD PRO 3.0 Rev 196 \PB\_Widget\_Designer.exe" Q3. Now the WD will cover the lower left screen quadrant when starting it via this shortcut.

This feature is possible as "Q..." is a so called command line argument from the application; other supported arguments are: [ViewerMode](#)<sup>864</sup>, STARTWDS, STARTWDP, STARTWDU

You may also use these additions with the command [ApplicationStart, Filepath, Optional Commandline Arguments](#)<sup>1396</sup>.

### Window State:

Choose between standard Windows Window States: Maximized, normal and minimized.

You may as well use the shortcut [CTRL+SHIFT+M] to maximize the Interface on the primary screen.

Tick the following check boxes:

[Top Most] to always have the WD on top of all applications,

[Scrollbars Enabled] to enable Scrollbars (you will see them if the WD GUI is scaled smaller then its original size),

[Tray only] to only have the WD opened in the Tray,

[Run on System Start] to automatically start the WD on System Start. This option will write the WD to your autostart folder.

[Skinning] to turn the skinning off and on in case that web pages are displayed with the Widget Designer skinning colors.

### Touch Overlay:

This section is of interest if you like to use mouse or touch data that is not represented by the local mouse. Incoming data can be for example used to click a [Custom Script Button](#)<sup>884</sup> (see its "Interaction" settings in its Item Properties). To see the incoming input points as an Overlay over the normal Widget Designer interface, enable the "Show" check box and a setup a "Size"

The following input devices are supported: [AirScan](#)<sup>1155</sup>, [Camera Tracker](#)<sup>1224</sup>, [iPhone](#)<sup>1185</sup>, [Kinect](#)<sup>1162</sup>, [Remote Input](#)<sup>1182</sup>, [TUIO](#)<sup>1166</sup>.

In addition you can also receive inputs from a device that is physically connected and set up on the Pandoras Box Master or even Client system. The Client sends the mouse / touch / etc. inputs to the Master system which sends it through the [Widget Designer Device](#)<sup>609</sup> to the Widget Designer interface. You can choose whether the screen (i.e. output resolution) or UV data of a layer is of interest. For more info about sending screen / UV data, see the chapter about [Layer Picking](#)<sup>244</sup>.

### Startup Script:

If you like to run a script (consisting of one or more commands) each time the project is loaded, add the commands to the text box and tick the check box [Enabled]. The topic [Script Language](#)<sup>1254</sup> explains commands and how to use them in more detail.

Tip: You may use a [macro](#)<sup>1191</sup>.

## 17.2.2 FILE MENU

The file menu lists commands that influence WD projects and the main application's appearance.

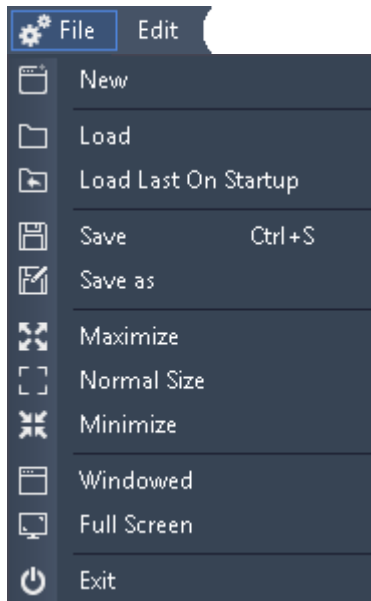

### NEW:

Creates a new WD project file.

### LOAD:

A click on load opens a file browser where you can choose the WD project file to be loaded. If you load a file created with an older WD version, it will be imported automatically. A pup-up window then asks you to re-save this file as new project.

### LOAD LAST ON STARTUP:

To load the current project on next start, click on "Load Last On Startup" to enable this feature.

### SAVE:

Click on save or use the shortcut [CTRL+S] to save your WD project file.

At the location you specified a folder will be created. Inside this folder you will find the WD project file (xxx.wdp) as well as data-folder containing all images applied to different controls in WD.

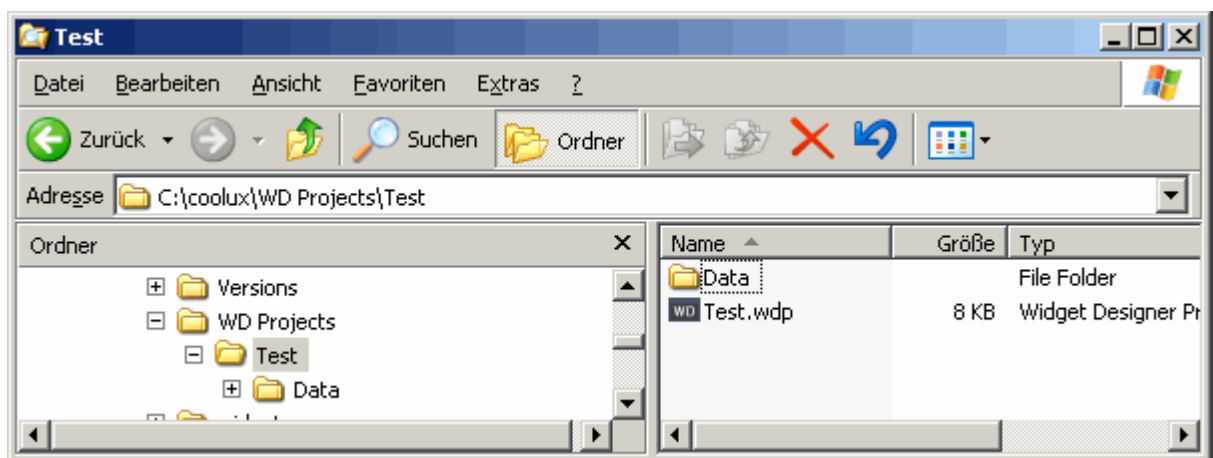

### SAVE AS...:

Use this option to save the current WD project file under a different name.



Please note: WD only asks you to save the current project file when exiting the application, there is NO AUTOSAVE.

#### MAXIMIZE:

Maximizes the WD window over the whole screen.

#### NORMAL SIZE:

Brings the WD to the size and style set in the [Main GUI's Item Properties](#)<sup>870</sup>.

#### MINIMIZE:

Minimizes the WD window.

#### WINDOWED:

Does the same as the command "Normal Size" but shows the standard Windows border and application title bar in addition.

#### FULL SCREEN:

Does the same as the command "Maximize" but hides the standard Windows border and application title bar for sure. This gives you the largest available space to arrange any controls forming an individual user interface.

You may as well use the shortcut [CTRL+SHIFT+F]

#### EXIT:

Closes the application (with asking if changes made within a project should be saved).

### 17.2.3 EDIT MENU

The edit menu lists commands influencing the setup of your working environment like controls, pages and IP configuration.

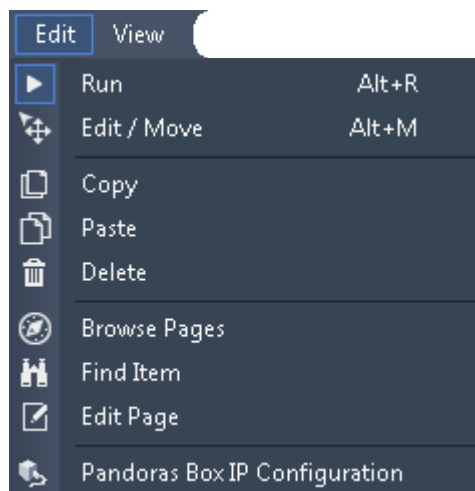

#### RUN:

Activates the operating mode called "run mode". [Here](#)<sup>869</sup> the operating modes are explained.

#### EDIT /MOVE:

Activates the operating mode called "edit / move mode" (Shortcut: [Alt + M]).

#### COPY:

Copies controls that have been selected before.

**PASTE:**

Pastes controls that have been copied before. The controls are inserted according to the mouse pointer's position. If you like to paste controls to another page use the shortcut [CTRL + P] while being in the edit / move mode.

**DELETE:**

Deletes controls that have been selected before.

**BROWSE PAGES:**

Opens a browser where all pages created are displayed with a thumbnail and their name. This makes it possible to navigate satisfactorily through many pages. The browser is explained [here](#)<sup>881</sup> in-depth.

**FIND ITEM:**

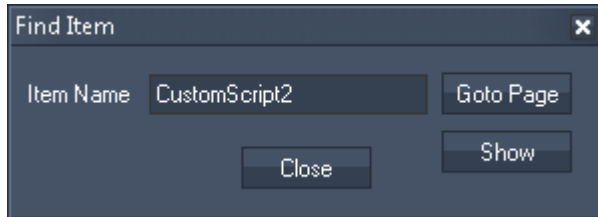

Opens a dialog where you may enter a control's name. "Goto Page" calls the page where the control is located. "Show" will not switch pages but overlays them with the control. The control will flash three times and then stay in front of them until you go to its source page. Thus you may use the control or edit its item properties.

**FIND ENTRY:**

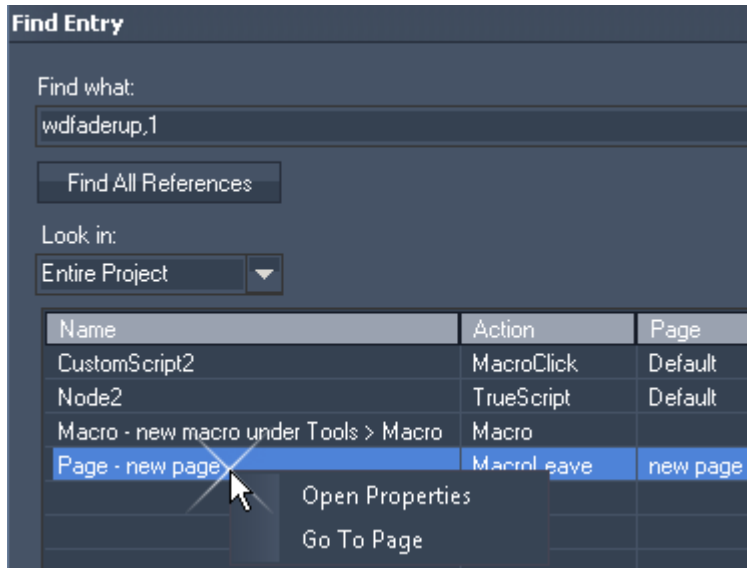

Opens a dialog where you may enter a (part) of a command. "Look in" opens a drop-down list where you may choose to search the entire project or only on the current page. "Find all References" starts the search and displays where the command was found, for example in a [Custom Script Button](#)<sup>884</sup>, a [Script Output node](#)<sup>1129</sup>, a [Macro](#)<sup>1191</sup>, or [Page](#)<sup>880</sup>. Right-click on the result to open the according properties or go to the page where it is located.

If you look for a tool that helps you debugging i.e. finding errors in your command programming, open [Tools > Options > Debug](#)<sup>1252</sup>.

**SHOW RUNNING SCRIPTS:**

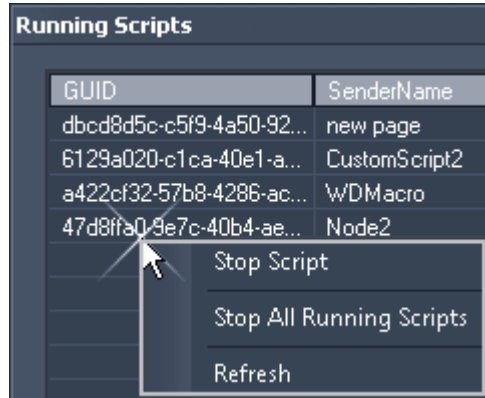

Opens a dialog where you may see all currently running scripts. The GUID is the "Globally Unique Identifier". The SenderName refers to where a script is executed from, e.g. from a [Custom Script Button](#)<sup>884</sup>, a [Script Output node](#)<sup>1129</sup>, a [Macro](#)<sup>1191</sup>, or [Page](#)<sup>880</sup>.

The dialog is meant to help finding out whether there is a script being executed and allows to stop it. Right-click on an entry to get access to the stop and refresh commands.

**EDIT PAGE:**

Opens a dialog where you may change the page's item properties like its name, password, background and enter / leave script as described [here](#)<sup>880</sup> in more detail. In addition, "Save Page as html to Web-Root" exports the page as an html file saved in a sub-folder called web\_root within the project folder. This is particularly interesting when working with the [Web Server](#)<sup>1177</sup> and wanting to design the web pages differently.

**MOVE ITEM TO PAGE:**

Opens a dialog where you may choose to which page the selected item(s) should be moved.

**PANDORAS BOX IP CONFIGURATION:**

Opens a dialog where you may change the network settings when communicating with Pandoras Box or other software. The dialog is explained [here](#)<sup>865</sup> in-depth.

**17.2.4 VIEW**

The view menu lists commands influencing how your working environment looks and behaves.

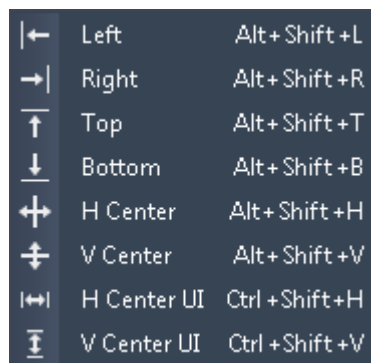
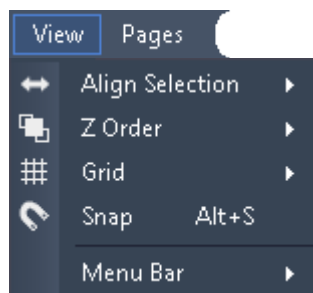

**ALIGN SELECTION:**

To align multiple UI elements to each other you will first need to select the items whilst being in the edit mode and then apply the desired alignment method.

Please click [here](#)<sup>869</sup> when you like to learn more about the edit mode.

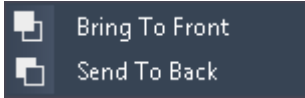

**Z ORDER:**  
 When you need to place one element on top of another you may click on the desired element(s) and choose "Send to Back" or "Bring to Front". Please note, that shapes are always placed in the background.



**GRID:**  
 "Show Grid" will display a pattern in the background. In the "Settings" dialog you can adjust its size.

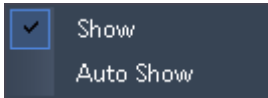

**SNAP:**  
 With the snap feature you may use the (in-)visible grid as magnetic guides.

**MENU BAR:**  
 You may decide whether you like the top menu bar to be shown always or never or only when the mouse is moved there. Contrary to the Windows title bar, the menu bar does not reduce the size of the background window, thus controls are able to overlay the bar.

### 17.2.5 PAGES

The pages menu lists all pages you have already created and eases the navigation through your custom user interface. See also: [Page Browser](#)<sup>881</sup>

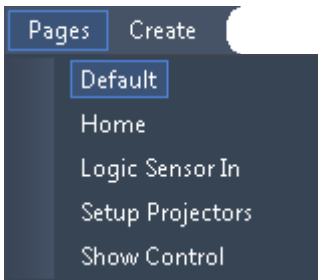

### 17.2.6 CREATE

The create menu lists all controls you may create. The image shown below gives an overview how many controls Widget Designer supports. The ones with a star-like icon are available as a [Web Server](#)<sup>1177</sup> control as well.

In Widget Designer, once you have chosen an item the mouse cursor will change to a crosshair icon. Wherever you left-click now, the chosen item is generated. More information about working with controls can be found [here](#)<sup>879</sup>.

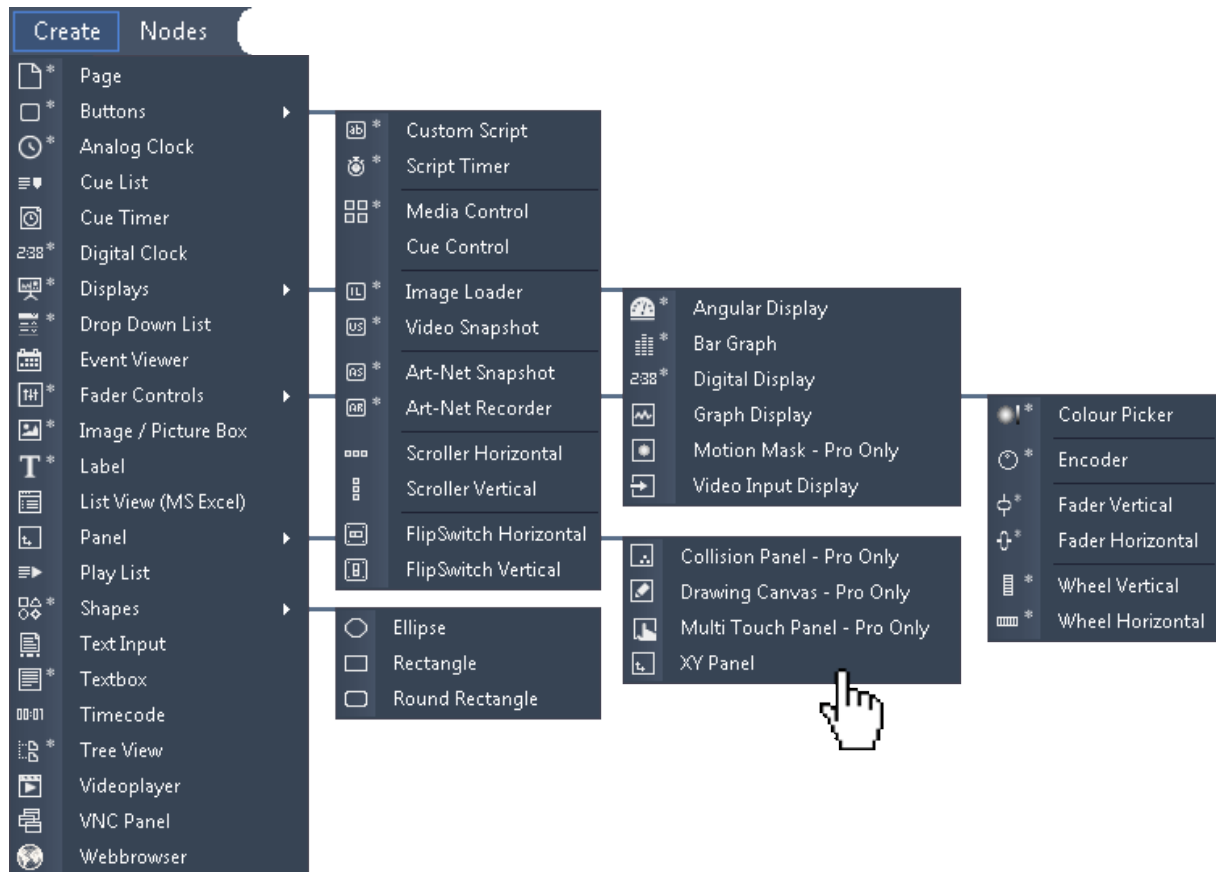

### 17.2.7 NODES

The nodes menu lists all nodes you may create, currently there are about 200 nodes available.

Once you have chosen a node the mouse cursor will change to a crosshair icon. Wherever you left-click now, the chosen node is generated. More information about working with nodes and an overview about all available nodes in Widget Designer Version 4 can be found [here](#)<sup>959</sup>.

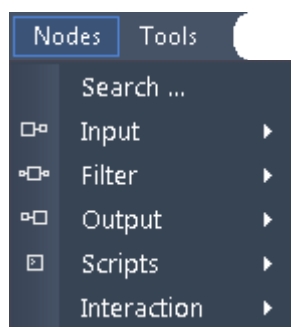

## 17.2.8 KEYBOARD SHORTCUTS

### File:

CTRL + S	Save
CTRL + SHIFT + S	Save as
ALT + F4	Exit Application
F1	Help

### User Interface:

ALT + R	Run Mode
ALT + M	Edit / Move Mode
ALT + S	Toggle Snap at Grid
ALT + G	Toggle Grid
CTRL + SHIFT + M	Maximize the Interface on the Primary Screen
CTRL + SHIFT + T	Show Main GUI Title Bar
CTRL + SHIFT + F	Hide Main GUI Title Bar
Page Up	Next Page in order (if in edit / move mode)
Page Down	Last Page in order (if in edit / move mode)
CTRL + SHIFT + T	Changes the window border style to Icon Title Window
Ctrl+Shift+P	Toggle Protection Mode (UI cannot be toggled into Edit mode etc.)

### Selection:

CTRL + A	Select all controls and nodes on current page
CTRL + Mouse	Multi-select controls and nodes
ESC	Clear current selection
CTRL + C	Copy
CTRL + V	Paste (if in edit / move mode)
CTRL + P	Paste controls at the same location (useful when group of controls need to be copied to multiple pages; works only in the edit mode)
CTRL + ARROW	Move selected items
ALT + P	Item Properties (when mouse cursor placed over a control)
F2	Edit Node (when mouse cursor placed over a node)

### Align Selection:

ALT + SHIFT + L	Align Selection to the left border
ALT + SHIFT + R	Align Selection to the right border
ALT + SHIFT + T	Align Selection to the top border
ALT + SHIFT + B	Align Selection to the bottom border
ALT + SHIFT + H	Align Selection to its horizontal center
ALT + SHIFT + V	Align Selection to its vertical center
CTRL + SHIFT + H	Align Selection to the horizontal center of the UI
CTRL + SHIFT + V	Align Selection to the vertical center of the UI.

### 17.3 CONTROLS

To create a control

- a) open the create menu from the main toolbar or
- b) right-click anywhere in the empty main background, go to "Create"

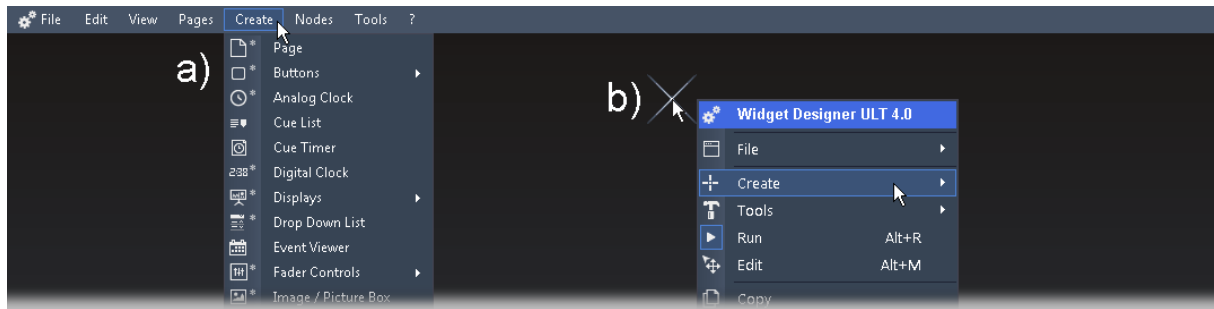

...and choose the desired control. The mouse cursor will change to a crosshair icon, telling you that you are in the [operating mode](#)<sup>869</sup> called "create mode". Wherever you left-click now, the chosen item is generated. When you have as many copies from the item as you need, enter the edit / move mode to edit, e.g. move or resize them or enter the run mode in order to use their function.

If you want to set up the properties of the newly built control, right-click on it and choose the menu entry "Item Properties" or press [Alt+P]. The controls property dialog opens up. It contains all properties influencing the control's behavior and look, as well as its ID which is important when you want to use it together with a [node](#)<sup>959</sup> or [command](#)<sup>1254</sup>. As you will need them many times, the Control IDs are displayed when you are in the edit / move mode [Alt+M].

Use the keyboard shortcuts [CTRL+C] and [CTRL+V] in order to copy and paste items, use the [DELETE] key if you want to erase them. These commands can be found in the edit menu as well.

The image shown below gives an overview how many controls Widget Designer supports. The ones with a star-like icon are available as a [Web Server](#)<sup>1177</sup> control as well. The image contains links to the respective description of each control. Please left-click into the image if you want to learn more about a specific control.

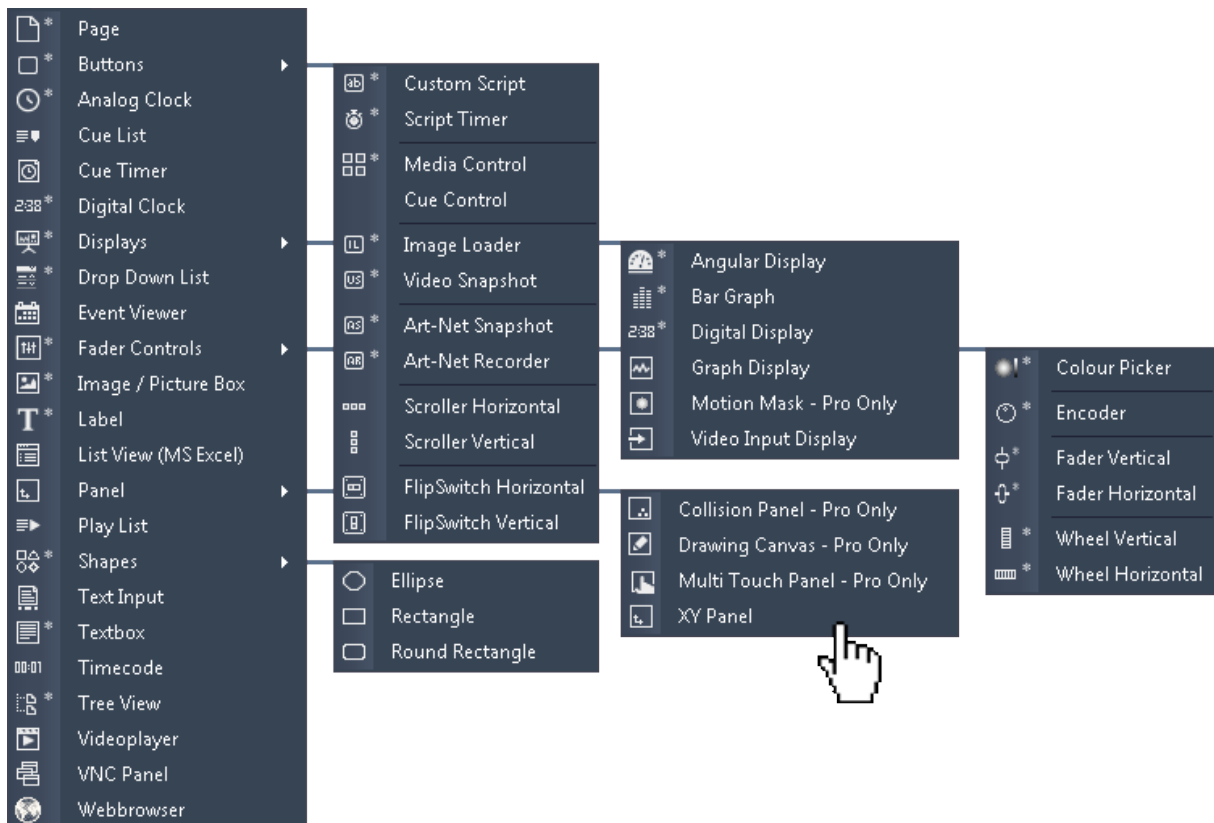

**17.3.1 PAGE**

Widget Designer supports unlimited pages to create dynamic menu systems. Buttons and [commands](#)<sup>1254</sup> can be used to change from one page to another.

To create a new page right-click anywhere on the empty main background window and go to "Create"->"Page" or choose the command from the main menu bar. The Page Creation Dialog opens up.

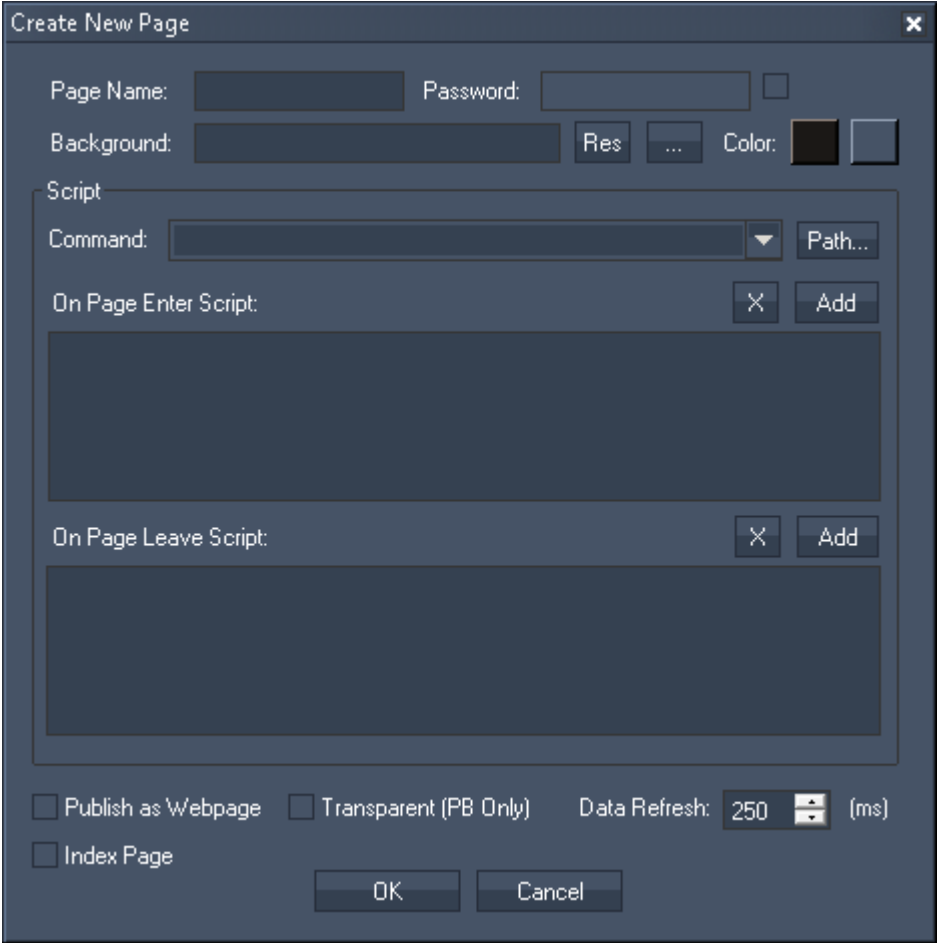

**Settings in the page dialog**

**Page dialog Page Name:**  
To create the new Page enter a new page name and click OK.

**Password:**  
If you want this page to be password protected, enable the little check box and enter a password. This will be requested when changing onto this page.

**Background:**  
You may set up a background image. Choose the directory with the [...] button or choose an image within the [Image Resource Manager](#)<sup>1249</sup> with the [Res] button. Alternatively a solid color or gradient can be set with the color field buttons.



#### Script:

In the Script section you may enter custom commands that will be assigned as On-Page-Enter- or On-Page-Leave-Script. This way you can assign an additional action to every page change. You may use the drop-down list and the "Add" button or type directly in the text field. The topic [Script Language](#)<sup>1254</sup> explains this in more detail.

See here a list of all [commands](#)<sup>1260</sup>.

#### Publish as Webpage:

Tick the check box if you like to publish the page as an html file to be accessed online through any web browser. The topic [Web Server](#)<sup>1177</sup> includes more details regarding this feature.

#### Index Page:

The dedicated page will be exported as the index html page, the one that is called as the main / default page. The topic [Web Server](#)<sup>1177</sup> includes more details regarding this feature.

#### Data Refresh:

The set time influences the refresh rate from html sites. The topic [Web Server](#)<sup>1177</sup> includes more details regarding this feature.

#### Transparent (PB Only):

An upcoming software version will assign a function to this check box.

### Edit page and the Thumbnail Browser

If you want to edit the page settings (Page Name, Password, Script) later on, please do a right-click on the main GUI and choose "Edit Page". Then the Page Dialog will appear again, this time it will have an additional thumbnail preview and a button called "Save Page as html to Web-Root" which might be of interest when working with the [Web Server](#)<sup>1177</sup> feature.

To go to the newly build page right-click anywhere on the empty main background window and go to "Goto Page" to switch to your new page.

The right-click menu and the main menu bar (Edit > Browse Pages) offer a page browser, where you will see all pages as thumbnails:

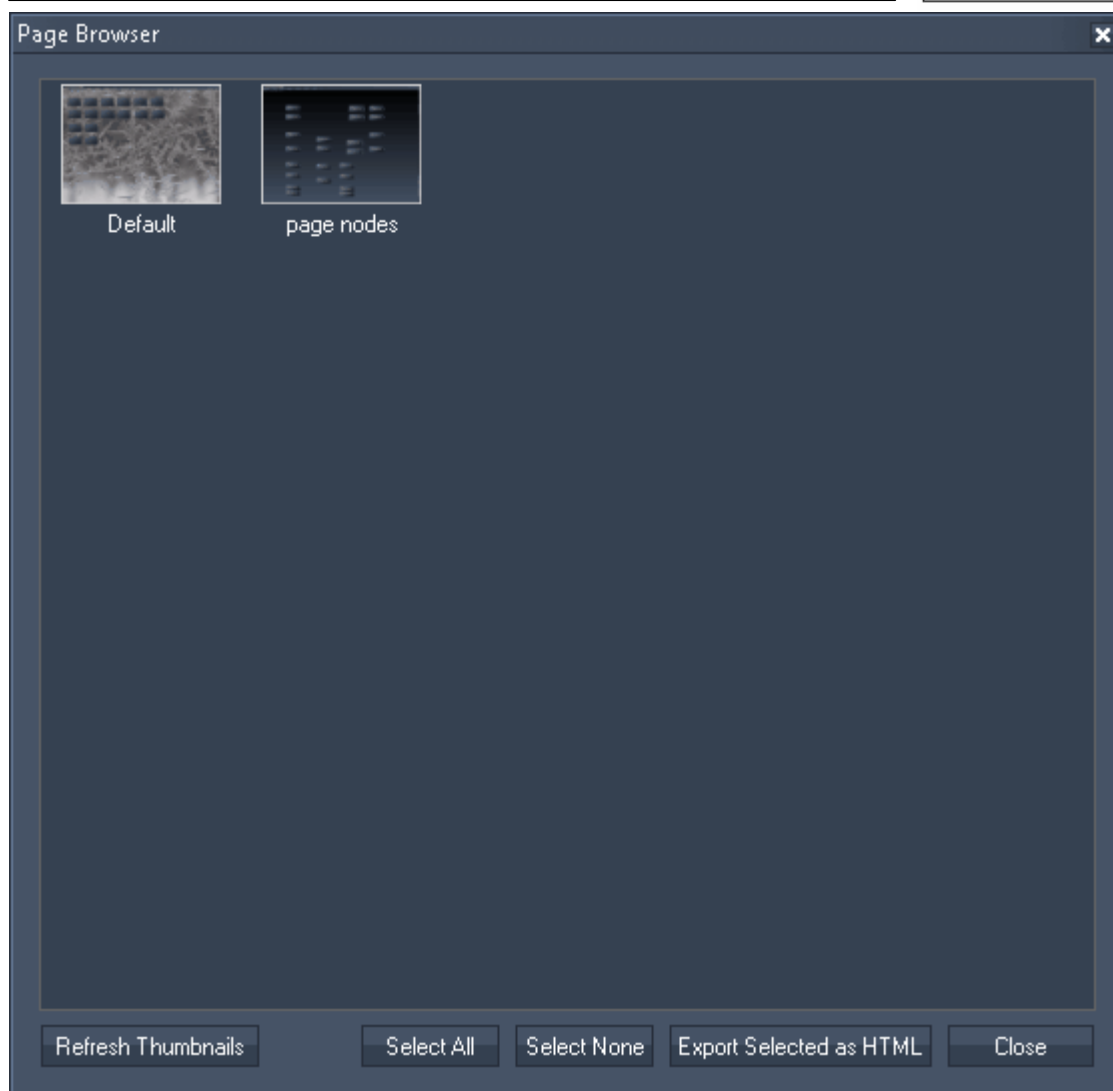

By clicking on one of the pages you will switch to this page as well.

Additionally, you may open the page browser via a command: [OpenPageBrowser](#)<sup>1419</sup>

### Specifics about Pages

When nodes are set up, different pages can help to keep an overview. If you like to deactivate (respectively mute) an output node when the page is not active, you can do so in the node's Item Properties. Upon Page enter all nodes of the entered page are automatically activated.

When VNC Panels are used with pages, the page change will cause all invisible VNC panels to disconnect their VNC Connection for performance reasons.

## 17.3.2 BUTTONS

Choose between various kinds of buttons:

### [Custom Script Buttons](#)<sup>884</sup>

The Custom Script Button control is the most flexible button control. With this control you can set up any button style and any click-able user interaction. Over 1000 commands are available to remote control all important Pandoras Box features as well as Widget Designer interface elements and much more.

### [Script Timer](#)<sup>888</sup>

The Script Timer control lets you execute commands after a certain amount of time. This can be done once or continuously.

### [Media Control](#)<sup>889</sup>

The Media Panel control is designed to create thumbnail button tables based on the thumbnail downloads of the CITP feature of Pandoras Box.

### [Cue Control](#)<sup>890</sup>

The Cue Control is designed to easily get access over the sequence control of Pandoras Box.

### [Image Loader](#)<sup>891</sup>

The Image Loader control is designed to easily exchange an image file that is added to the Pandoras Box project with any other image file.

### [Video Snapshot](#)<sup>893</sup>

The Video Snapshot control is designed to easily exchange an image file within a Pandoras Box project by a Video Snapshot from your attached Video Input.

### [Art-Net Snapshot](#)<sup>896</sup>

The Art-Net Snapshot Button is designed to record a full Art-Net DMX universe state, with the ability to record from Universe A and output to Universe B.

### [Art-Net Recorder](#)<sup>898</sup>

The Art-Net Recorder Button is designed to record a full Art-Net DMX universe over a certain time, with the ability to record from Universe A and output to Universe B.

### [Scroller Horizontal / Vertical](#)<sup>901</sup>

The Scroller is designed to change the X or Y position of assigned media files in your Pandoras Box project, so that you can scroll through a certain amount of pictures.

### [FlipSwitch Horizontal / Vertical](#)<sup>904</sup>

The Flipswitch is designed to execute commands only when the control reaches the specified unlock position.

### 17.3.2.1 CUSTOM SCRIPT BUTTON

The Custom Script Button allows you to execute one or more commands whenever the button is clicked or activated in a different way. You can set up any button style and any click-able user interaction. Over 1000 commands are available to remote control all important Pandoras Box features as well as Widget Designer interface elements and much more.



To create a Custom Script Button choose "Create > Buttons > Custom Script". To edit the Custom Script Button parameters simply right-click on the desired Custom Script Button control and choose the menu entry "Item Properties", press [ALT+P] whilst the mouse is hovering above it or double-click on it when being in the edit / move mode ([ALT+M]).

The Custom Script Button property dialog opens up.

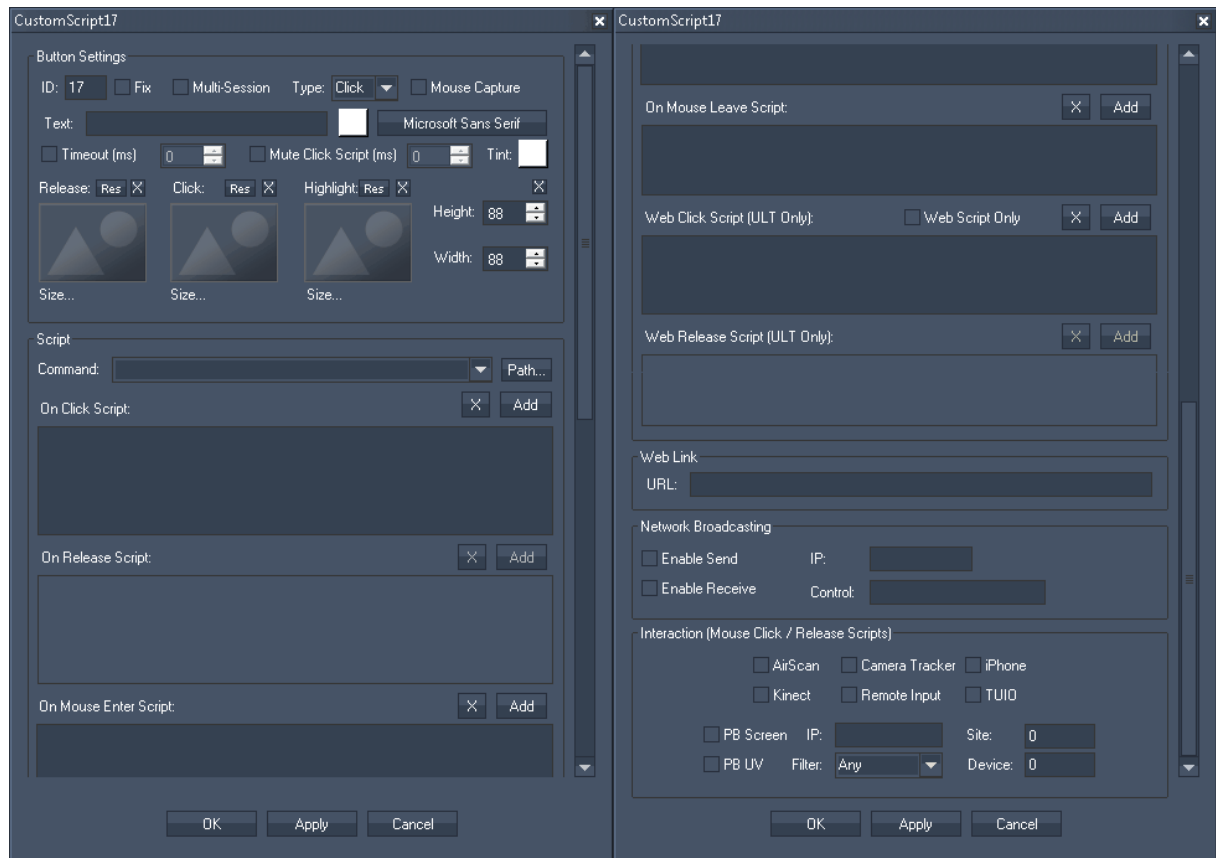

The property dialog is divided into five sections: Button Settings, Script, Web Link, Network Broadcasting and Interaction.

#### Button Settings

**ID:**

In the Button Settings the Button's ID may be changed by entering a new one.

**Fix:**

When the option "fix" is checked, the CS Button will be available from every page.

**Multi-Session (WD ULT only):**

When this option is checked, the CS Button can have different values according to each individual [Web](#)

[Server](#)<sup>1177</sup> session. Note that this is only for users of WD ULT. More is explained in the Script section and the topic [Member Values](#)<sup>1196</sup>.

Type:

You may set the button type to be Click, Flash or Toggle. The toggle state of the CS Button will be kept when the project is saved and loaded.

se" script and stays in the mode "Released" again.

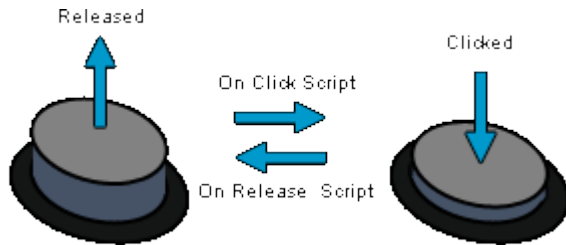

After creating a button it is always in the "Released" mode. A Button with the Click type has no other status. If you click on it, each time, the "On Click" script is executed, then the button is again into the "Released" mode.

A Flash Button also executes the "On Click" script when clicking on it; however it has a second mode. As long as you hold the mouse down on the button, it is in the mode "Clicked". When letting go, it executes the "On Release Script" and is in the "Released" mode again.

The toggle button too has two modes. First it is "Released". When clicking on it, the "On Click" script is executed and the button changes to the "Clicked" mode. The next time it is clicked, the "On Release" script is executed and the button changes to the "Released" mode again.

The modes can be indicated by an image (see below). There are [commands](#)<sup>1326</sup> that click a button, with or without executing the associated script and with or without changing the mode.

Mouse Capture:

Custom Script Buttons allow to capture a mouse left click even when WD GUI is in the background, as well as Mouse Enter and Mouse Leave events. This is useful when WD is used on the same machine as Pandoras Box Players or Servers.

Text:

Enter a label that will be displayed on the button. The text's color can be set via the color field and its font via the according button.

Timeout (ms):

The timeout setting can be used to call the click script after a given timeout. The timeout is always restarted upon mouse enter on the control.

This feature is particularly useful for AirScan or touch applications where the user can only position the mouse but not cause a click with the input device.

Mute Click Script:

Set a specific time in milliseconds for a Custom Script click script to be muted (not executed). This protects a Custom Script Button from accidental double clicks.

Tint:

Custom Script Buttons can be colored by selecting a tint color, this applies only to the default button images.

Three images can be assigned to the different states of the button (the modes are explained above).

"Release" refers to no click or not toggled.

"Click" is on press or toggled.

"Highlight" can be used to draw a png with alpha over either the click or release image.

Click on the image place holder itself to open a file dialog where you can choose your path and image. If you like to choose an image from the Widget Designer "library", click on the "Res" button. The [Resource Manager](#)<sup>1249</sup> opens where you can double-click on the image of your choice. You can also save custom images in the Resource Manager to access them faster.

Width and Height:

Enter a pixel size for the Custom Script Button's size.

## Script

In the Script section you may enter commands to be executed. You may use the drop-down list and the "Add" button or type directly in the text field. The topic [Script Language](#)<sup>1254</sup> explains this in more detail.

The scripts for Click, Release, Mouse Enter and Mouse Leave are executed if the local Widget Designer Button is being used. The Web Click and Web Release scripts are interesting if working with the [Web Server](#)<sup>1177</sup> feature. They are executed if the web instance of the button in a web browser is being used. If you are working with the [PRO edition](#)<sup>864</sup> of Widget Designer, you can run an unlimited number of web sessions. A CS button in any web browser is linked to the local WD copy and thus to all other web instances, too. That means, if the button was clicked in one browser, it executes the Web Click script and at the same time the local instance is automatically clicked too and executes the Click script. In this scenario you only want a web button to execute the Web Click script, activate the check box "Web Script Only". Now, the web buttons execute the web script and the WD button only executes the local script.

If you are working with the [ULT edition](#)<sup>864</sup> of Widget Designer, you can work with multi-sessions and additionally assign the multi-session type to the CS Button as well. Now the web buttons are not linked to the local WD button any more, as the button can have a [member value](#)<sup>1196</sup> and deviating session values. Thus there is no need to check this option anymore.

If you are interested in the Web Server feature and some small examples, please read the topics [Web Server](#)<sup>1177</sup> and [Member and Session Values](#)<sup>1196</sup>.

See here a list of all [commands](#)<sup>1260</sup>.

## Web Link

This section is only of interest when working with the [Web Server](#)<sup>1177</sup> feature, i.e. clicking the Custom Script Button in a web browser. Enter a URL e.g. "<http://www.coolux.com>" that your browser should call when clicking the button.

## Network Broadcasting

The NBS (Network Broadcast Service) allows transmitting and updating Faders, Labels and Custom Script Buttons across multiple WD Designers instances on the network. To activate this service, please refer to the [Remoting dialog](#)<sup>1184</sup>!

Sending values:

To send the Custom Script Buttons state (clicked or released) as broadcast into the network, you only have to check "Enable Send".

Receiving values:

To receive values from other Custom Script Buttons, please check "Enable Receive".

Now you have to specify which item should update your Custom Script Button:

Enter the IP address of the computer you want to listen to. This could be the local computer (to control the Custom Script Button through another Custom Script Button on the same Widget Designer) or a different computer in the network. If you do not want to specify the computer but want to listen to all computers in the network, enter "255.255.255.255".

As next step specify the Custom Script Button you want to take the status from. This could be e.g. "CustomScript1" or " CustomScript2").

### Interaction (Mouse Click / Release Scripts)

This section is of interest if you like to "click" a Custom Script Button without using a mouse device, including node solutions addressing a mouse. It is possible to use the input device directly to execute the "On Click / Release" or "On Mouse Enter / Leave" script. If the device generates more than one input event you can use all of them even if running a Win XP system that is normally restricted to one input event. The following input devices are supported: [AirScan](#)<sup>1155</sup>, [Camera Tracker](#)<sup>1224</sup>, [iPhone](#)<sup>1185</sup>, [Kinect](#)<sup>1162</sup>, [Remote Input](#)<sup>1182</sup>, [TUIO](#)<sup>1166</sup>.

In addition you can also receive inputs from a device that is physically connected and set up on the Pandoras Box Master or even Client system. The Client sends the mouse / touch / etc. inputs to the Master system which sends it through the [Widget Designer Device](#)<sup>609</sup> to the Widget Designer interface.

Set up the supported device connection as usual to generate input events. If you like to see these inputs, open the "[Main GUI Properties](#)<sup>870</sup>" (right-click in empty background > Item Properties). Look for the section "Touch Overlay" and enable "Show" and the according input option.

Last, open the Item Properties of the Custom Script Button that should receive the input data. Enter the script as usual and in the section "Interaction" enable then the check box for the input device, e.g Camera Tracker as shown in the below screenshot. If you like to click the button with data from a PB Master or Client, decide whether the screen (i.e. output resolution) or UV data of a layer is of interest. If you like to filter data from a specific site / layer only, enter the Master's IP address, then the Site (and Device ID) and the filter type. For more info about UV data see the chapter about [Layer Picking](#)<sup>244</sup>.

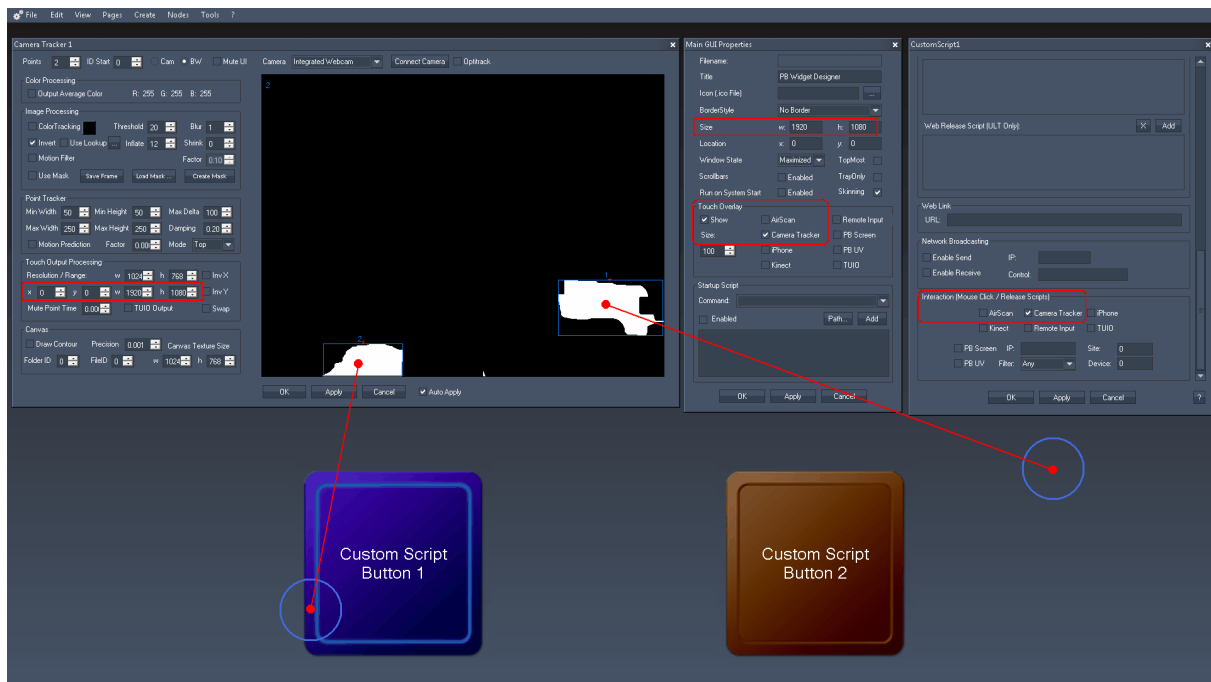

### 17.3.2.2 SCRIPT TIMER



The Script Timer control lets you execute a script after a certain amount of time. This can be done once or continuously.

By the first click on the Script Timer it will be started. A second click on it stops it again.

To edit the Script Timer's parameters simply right-click on the desired Script Timer control and choose the menu entry "Item Properties", press [ALT+P] whilst the mouse is hovering above it or double-click on it when being in the edit / move mode ([ALT+M]). The Script Timer Property Dialog opens up.

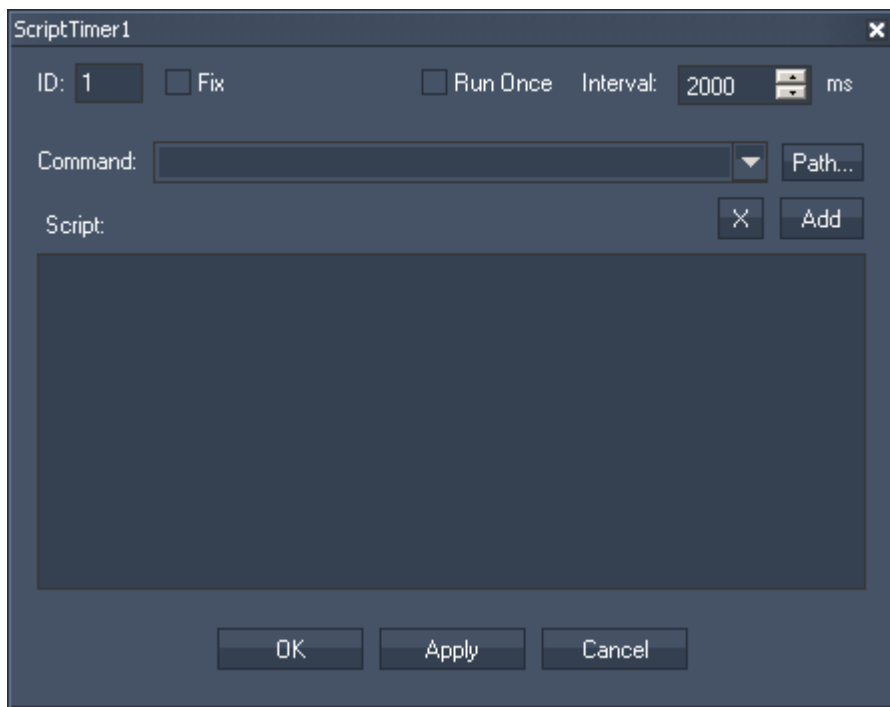

**ID:**

The Script Timer's ID may be changed by entering a new one in the text field top left.

**Fix:**

When the option "Fix" is checked, the Script Timer will be displayed on every page.

**Run Once:**

When "Run Once" is enabled, the Script Timer will execute the script once after the Interval Time is expired and then stops again.

When "Run Once" is disabled (by default) the Script Timer will execute the script continuously in the Interval you entered in the text field to the right (in ms).

**Interval:**

Enter here the Interval time in ms, after which the Script Timer executes the script once or continuously.

**Script:**

In the Script section you may enter commands to be executed. You may use the drop-down list and the "Add" button or type directly in the text field. The topic [Script Language](#)<sup>1254</sup> explains this in more detail. See here a list of all [commands](#)<sup>1260</sup>. To control the Script Timer itself via commands, please use [these ones](#)<sup>1375</sup>.



### 17.3.2.3 MEDIA CONTROL PANEL

The Media Panel control is designed to create thumbnail button tables based on the thumbnail downloads of the CITP feature of Pandoras Box.

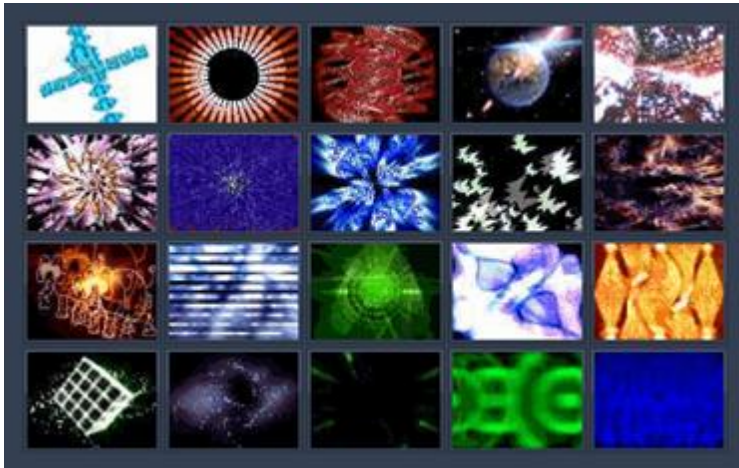

To edit the Media Panel parameters simply right-click on the desired Media Panel control and choose the menu entry "Item Properties", press [ALT+P] whilst the mouse is hovering above it or double-click on it when being in the edit / move mode ([ALT+M]). The Media Panel Property Dialog opens up.

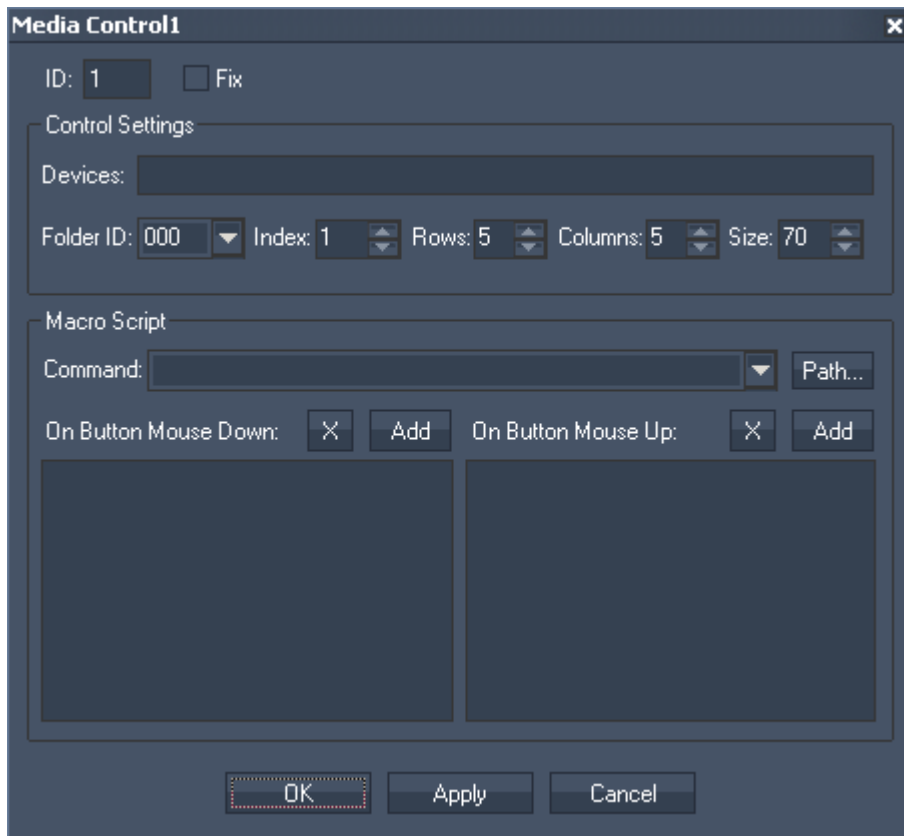

**ID:**  
The Media Control's ID may be changed by entering a new one in the text field top left.

**Fix:**  
When the option "Fix" is checked, the Media Control will be displayed on every page.

## Control Settings

The Control Settings section lets you design and set up the Media Control Panel.

### Devices:

To assign the media files to one or multiple devices, enter the site and device ID into the device text field.

### Example:

To assign the media files to Layer1 of Server1 and Layer1 of Server2 enter "1.1 2.1"

### Folder ID, Index, Rows and Columns:

The media control is automatically built based on the selected FolderID, the start index of the files as well as the rows and columns count.

### Size:

The size sets the width of every thumbnail button.

## Script

In the Script section you may enter commands to be executed. They will be assigned to all buttons of the Media Panel. This way you can assign an additional action to every media change, e.g. an opacity fade-in.

To enter commands you may use the drop-down list and the "Add" button or type directly in the text field. The topic [Script Language](#)<sup>1254</sup> explains this in more detail.

See here a list of all [commands](#)<sup>1260</sup>.

### 17.3.2.4 CUE CONTROL

The Cue Control is designed to easily get access over the sequence control of Pandoras Box.

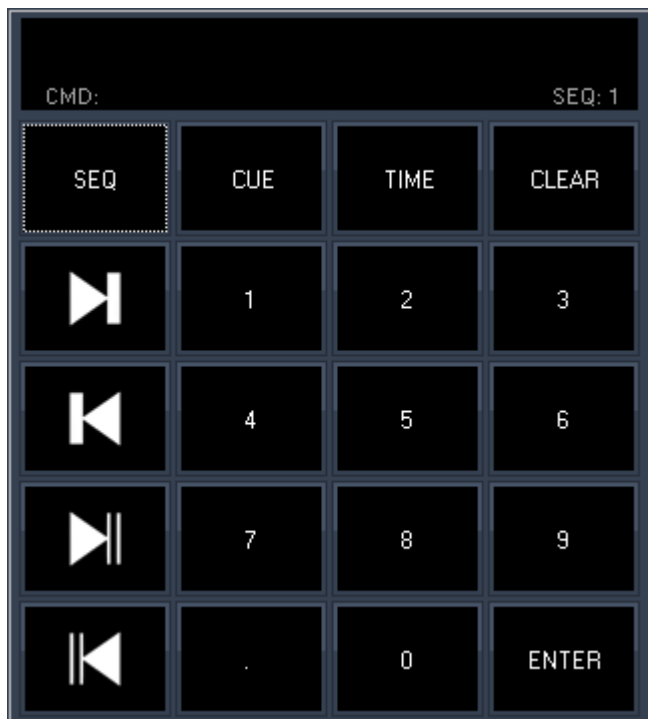

### Sequence:

By default the Cue Control is assigned to Sequence 1 (displayed down right in the command window).

To change the sequence you want to control, please press [SEQ+SeqID+ENTER], e.g. SEQ+2 will control Seq. 2 as long as you do not change the sequence.

Cues:

To jump to the next / last Cue or frame in the sequence, use the arrow buttons on the left.

To jump to a dedicated Cue, please press

[CUE+CueID+ENTER], e.g. [CUE+5+ENTER] and the nowpointer jumps to Cue 5.

As long as you do not press another command like SEQ, TIME or CLEAR entering any number + ENTER will be interpreted as "jump to Cue xx".

Time:

To jump to a specific timecode, please press

[TIME+hh:mm:ss:ff+ENTER], e.g. [TIME+1041513+ENTER] lets the nowpointer jumps to the timecode 1:04:15:13.

A more simple way to enter the timecode is to just enter the last numbers different from 0, e.g. [TIME+213+ENTER] lets the nowpointer jumps to the timecode 0:00:02:13.

As long as you do not press another command like SEQ, CUE or CLEAR entering any number + ENTER will be interpreted as "jump to Timecode xx".

Clear:

Press [Clear] to clear the current entered values.

### 17.3.2.5 IMAGE LOADER

The Image Loader control is designed to easily exchange an image file that is added to the Pandoras Box project with any other image file on your PC. An interesting application for this could be e.g. if pictures of the audience are made and by button click are displayed on a Pandoras Box output.

Click on the Image Loader Button and a Windows explorer opens at the locations, from where you want to sent image files to Pandoras Box.

The newly loaded image file will automatically spread to all connected clients.

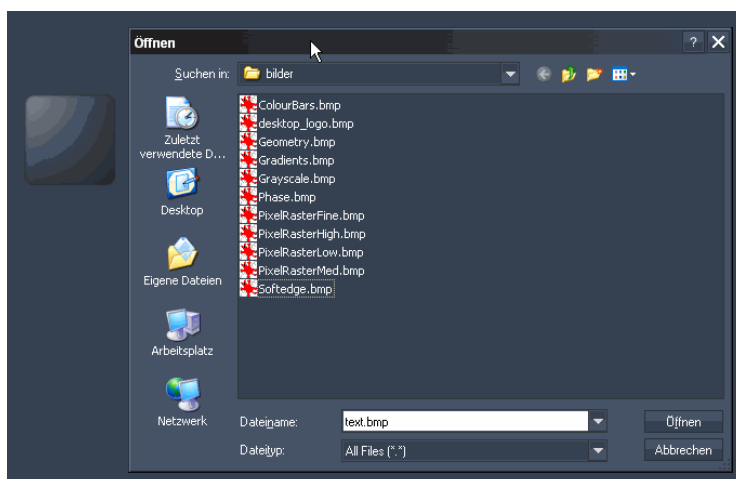

To edit the Image Loader parameters simply right-click on the Image Loader button and choose the menu entry "Item Properties", press [ALT+P] whilst the mouse is hovering above it or double-click on it when being in the edit / move mode ([ALT+M]). The Image Loader Property Dialog opens up.

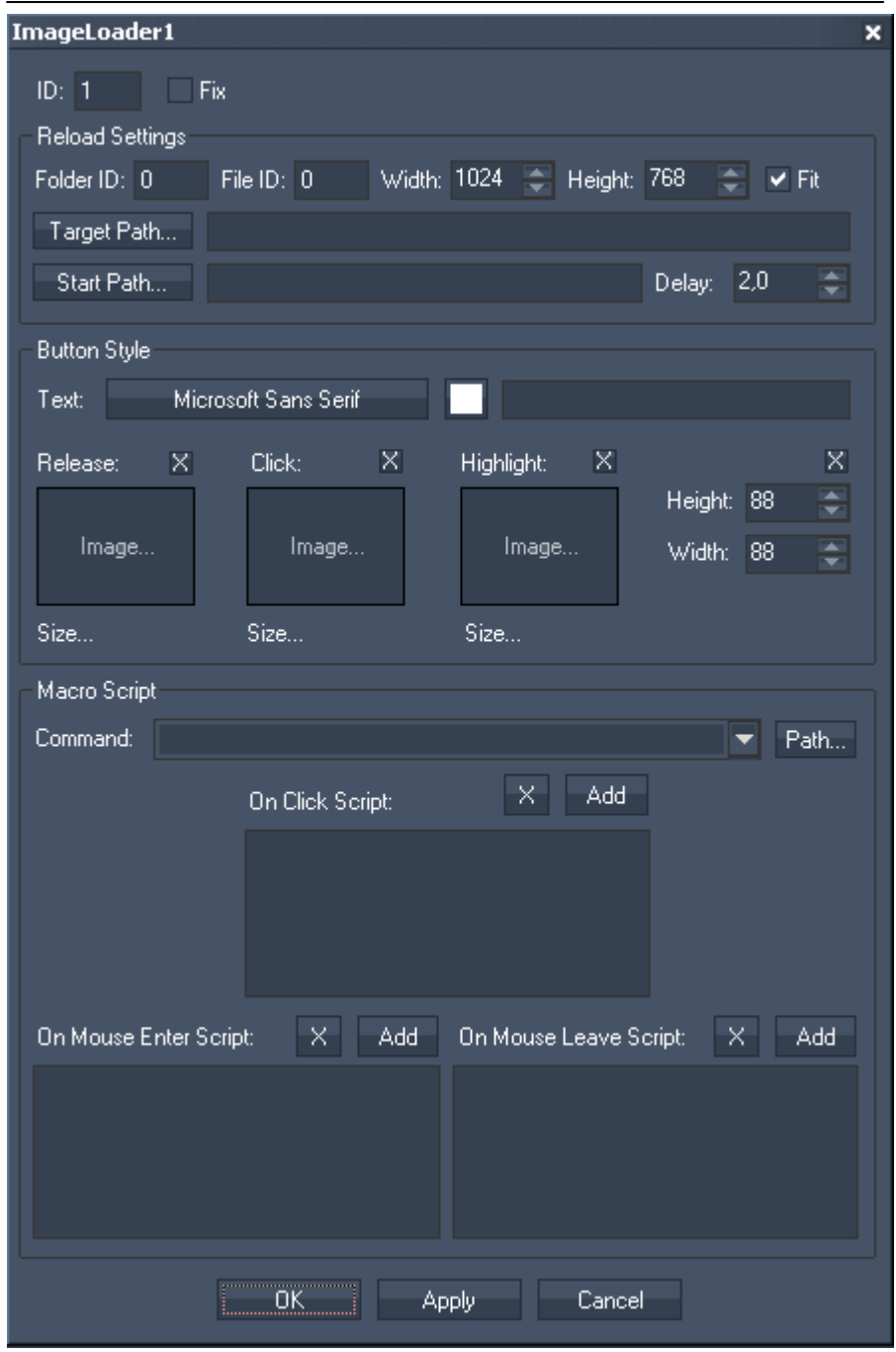

**ID:**  
The Image Loader's ID may be changed by entering a new one in the text field top left.

**Fix:**  
When the option "Fix" is checked, the Image Loader Button will be displayed on every page.

The Image Loader Property dialog is divided into three sections.

**Reload Settings**

**Folder and File ID:**  
Enter here the File and Folder ID of the image in Pandoras Box, to which the new image should be loaded.

Width, Height, Fix:

You may enter the Width and Height the image should get. Press Fit to enable this size option, otherwise the image will be fitted to the size of the original image file inside Pandoras Box.

Target Path:

Press [Target Path...] and browse to the image file which should be exchanged through the new loaded images.

Start Path:

Press [Start Path...] and choose or create a folder, from where you later choose the new image files, that should be transferred to Pandoras Box.

Delay:

The Delay between copying the new image to the original image file and loading it inside Pandoras Box is set to 2,0 secs. This delay is set to be sure that the copy process is finished before the image is loaded into Pandoras Box. This value can be edited by entering a new delay time.

## Button Style

In the Button Style you may set up the button's text as well as its font and colour.

Three images can be assigned to the different states of the button.

"Release" refers to no click.

"Click" is on press.

"Highlight" can be used to draw a png with alpha over either the click or release image.

You may also set the Buttons Height and Width.

## Script

In the Script section you may enter commands to be executed. You may use the drop-down list and the "Add" button or type directly in the text field. The topic [Script Language](#)<sup>1254</sup> explains this in more detail. See here a list of all [commands](#)<sup>1260</sup>.

### 17.3.2.6 VIDEO SNAPSHOT

The Video Snapshot control is designed to easily exchange an image file within a Pandoras Box project by a Video Snapshot from your attached Video Input.



A click on the Video Snapshot Button and the created snapshot is immediately send to an image file within Pandoras Box.

The newly loaded image file will automatically spread to all connected clients.

To send a Video Snapshot to Pandoras Box, you need to

1. have an image file added into Pandoras Box project with assigned [File and Folder ID](#)<sup>190</sup>.
2. create a [Video Input Display](#)<sup>918</sup> and enter the Video Input ID of your Video Source.
3. set up the Video Snapshot Properties, see below.

To edit the Video Snapshot parameters simply right-click on the Video Snapshot Button and choose the menu entry "Item Properties", press [ALT+P] whilst the mouse is hovering above it or double-click on it when being in the edit / move mode ([ALT+M]). The Video Snapshot Property Dialog opens up.

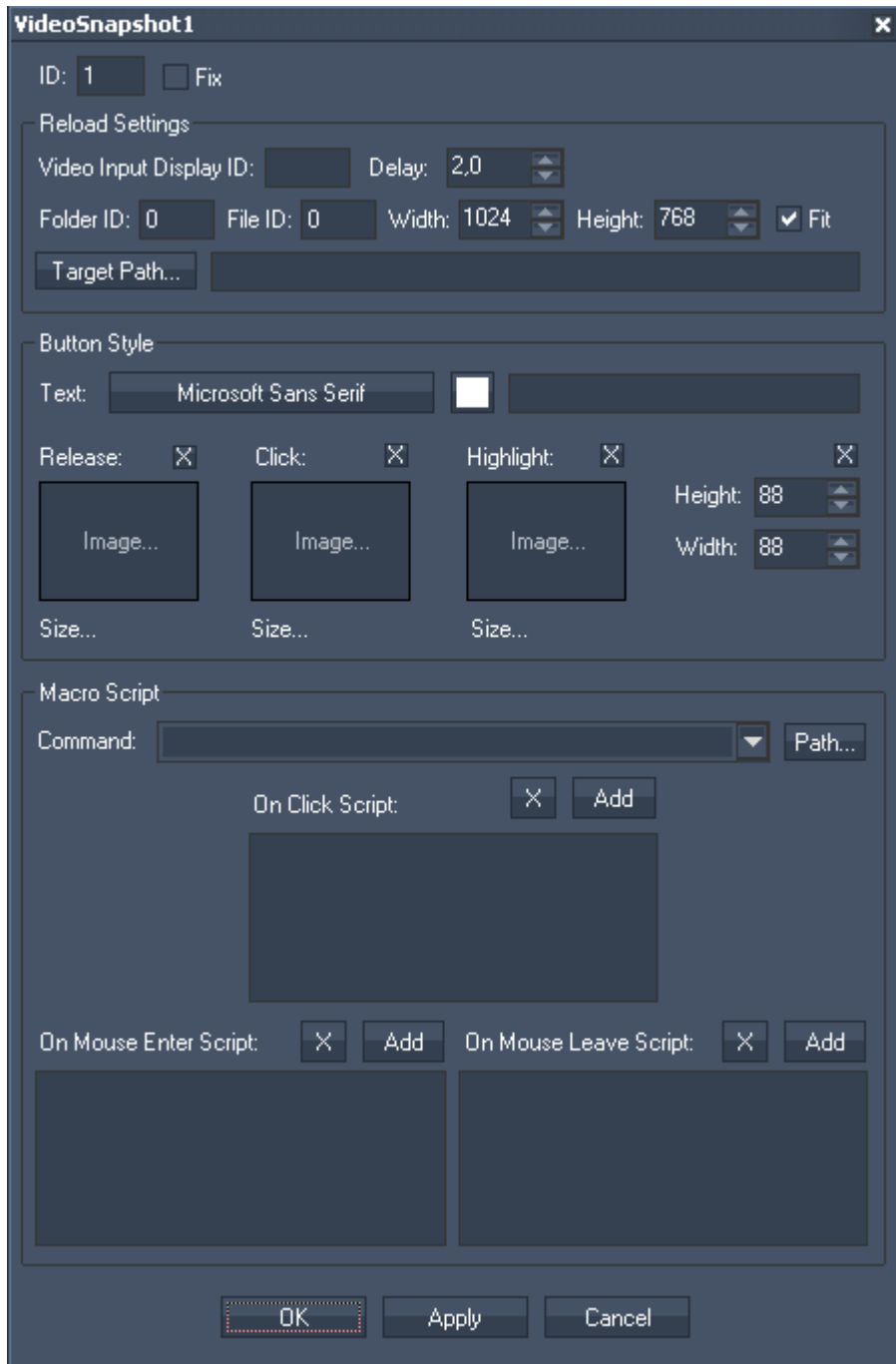

**ID:**  
The Video Snapshot's ID may be changed by entering a new one in the text field top left.

**Fix:**  
When the option "Fix" is checked, the Video Snapshot Button will be displayed on every page.

The Video Snapshot Property dialog is divided into three sections.

---

## Reload Settings

Video Input Display ID:

Enter the [Video Input Display](#)<sup>918</sup> ID the Video Snapshot should be taken from.

Delay:

The Delay between copying the new image to the original image file and loading it inside Pandoras Box is set to 2,0 secs by default. This delay is set to be sure that the copy process is finished before the image is loaded into Pandoras Box. This value can be edited by entering a new delay time.

Folder and File ID:

Enter the File and Folder ID of the image in Pandoras Box, to which the video snapshot should be loaded.

Width and Height:

You may enter the Width and Height the image should get. Press Fit to enable this size option, otherwise the image will be fitted to the size of the original image file inside Pandoras Box.

Target Path:

Press [Target Path...] and browse to the image file which should be exchanged by the newly loaded video snapshot.

## Button Style

In the Button Style you may set up the button's text as well as its font and colour.

Three images can be assigned to the different states of the button.

“Release” refers to no click.

“Click” is on press.

“Highlight” can be used to draw a png with alpha over either the click or release image.

You may also set the Buttons Height and Width.

## Script

In the Script section you may enter commands to be executed. You may use the drop-down list and the "Add" button or type directly in the text field. The topic [Script Language](#)<sup>1254</sup> explains this in more detail.

See here a list of all [commands](#)<sup>1260</sup>.

### 17.3.2.7 ART-NET SNAPSHOT

The Art-Net Snapshot Button is designed to record a full Art-Net DMX universe state, with the ability to record from Universe A and output to Universe B.

A click on the Art-Net Snapshot Button and the captured Art-Net values are send out to the specified Universe.

Please note:

In order to use the Art-Net Snapshot Button Art-Net Input and Art-Net Output needs to be enabled in the [Connection Manager](#)<sup>[1166]</sup>!

To edit the Art-Net Snapshot parameters simply right-click on the Art-Net Snapshot Button and choose the menu entry "Item Properties", press [ALT+P] whilst the mouse is hovering above it or double-click on it when being in the edit / move mode ([ALT+M]). The Art-Net Snapshot Property Dialog opens up.

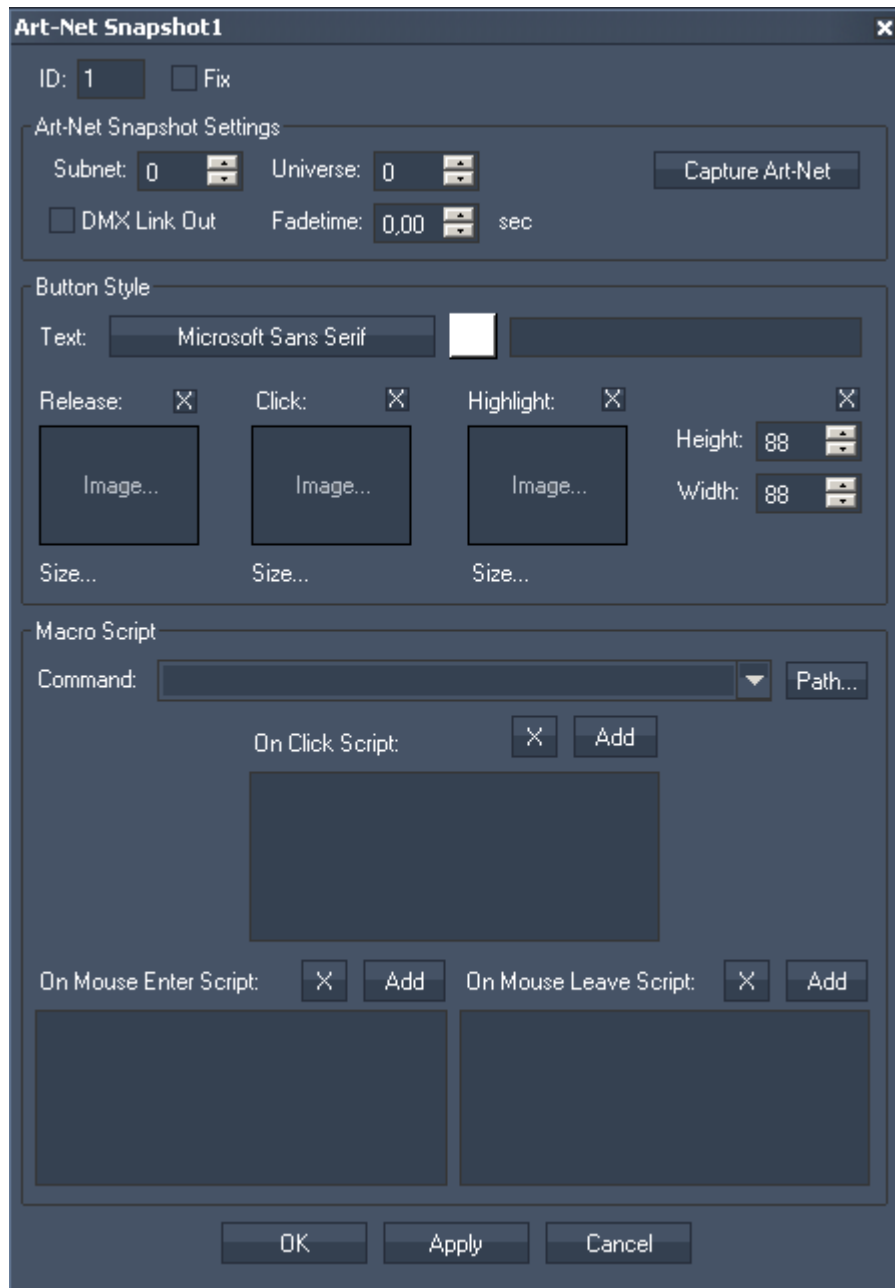



**ID:**

The Art-Net Snapshot's ID may be changed by entering a new one in the text field top left.

**Fix:**

When the option "Fix" is checked, the Art-Net Snapshot Button will be displayed on every page.

The Art-Net Snapshot Property dialog is divided into three sections: Art-Net Snapshot Settings, Button Style and Script.

## Art-Net Snapshot Settings

**Subnet and Universe:**

Enter the Subnet and Universe the Art-Net values should be captured from.

**DMX Link Out:**

Check this option if you want to play out the Art-Net values via the DMX Link 1 Port Output device.

Please note that the device has to be enabled in the [Connection Manager](#)<sup>1168</sup>.

**Fade Time:**

If you want to fade to the Art-Net values stored in this button instead of sending them out abruptly, you may define a fade time here (in sec).

**[Capture Art-Net]:**

Press [Capture Art-Net] and the current state of the specified Universe will be recorded.

To send out these Art-Net values on the same Universe, close the Item Properties dialog and just press the Art-Net Snapshot Button.

To send out these Art-Net values on a different Universe, do it as following:

Enter the Subnet and Universe the Art-Net values should be captured from.

Press [Capture Art-Net] and the current state of the specified Universe will be recorded.

Now change the Art-Net settings to the Universe on which you want to send out the recorded Art-Net values (do NOT press [Capture Art-Net] again) and press [OK] or [Apply] at the bottom of the Item Properties dialog. Close this dialog and click on the Art-Net Snapshot Button.

## Button Style

In the Button Style you may set up the button's text as well as its font and colour.

Three images can be assigned to the different states of the button.

"Release" refers to no click.

"Click" is on press.

"Highlight" can be used to draw a png with alpha over either the click or release image.

You may also set the Buttons Height and Width.

## Script

In the Script section you may enter commands to be executed. You may use the drop-down list and the "Add" button or type directly in the text field. The topic [Script Language](#)<sup>1254</sup> explains this in more detail. See here a list of all [commands](#)<sup>1260</sup>. [These ones](#)<sup>1317</sup> are available to control the Art-Net Snapshot Button itself.

---

### 17.3.2.8 ART-NET RECORDER

The Art-Net Recorder button is designed to record a full Art-Net DMX universe over a certain time, with the ability to record from Universe A and output to Universe B.

A click on the Art-Net Recorder and the captured Art-Net sequence is send out to the specified Universe.

Please note:

In order to use the Art-Net Recorder Art-Net Input and Art-Net Output needs to be enabled in the [Connection Manager](#)<sup>[1166]</sup>!

To edit the Art-Net Recorder parameters simply right-click on the Art-Net Recorder Button and choose the menu entry "Item Properties", press [ALT+P] whilst the mouse is hovering above it or double-click on it when being in the edit / move mode ([ALT+M]). The Art-Net Recorder Property Dialog opens up.

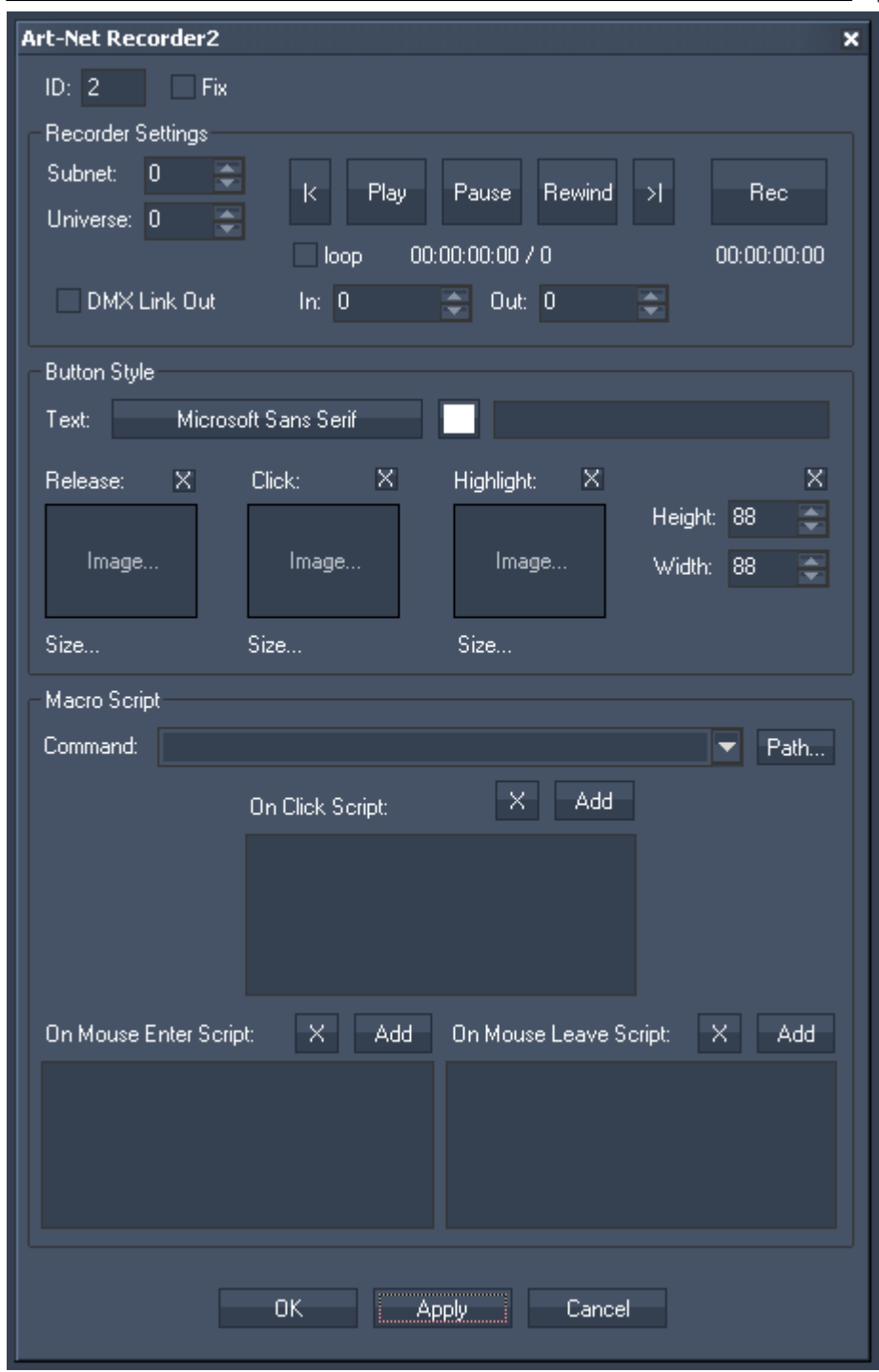

**ID:**  
The Art-Net Recorder’s ID may be changed by entering a new one in the text field top left.

**Fix:**  
When the option “Fix” is checked, the Art-Net Recorder Button will be displayed on every page.

The Art-Net Recorder Property dialog is divided into three sections.

**Recorder Settings**

**Subnet and Universe:**  
Enter the Subnet and Universe the Art-Net values should be recorded from.

**[Rec]:**

Press [Rec] and the specified Universe will be recorded until you press the button again, that meanwhile changes its name to [Stop].

To send out the Art-Net values on the same Universe they were recorded from, close the Item Properties dialog and just press the Art-Net Recorder Button.

To send out these Art-Net values on a different Universe, do it as following:

Enter the Subnet and Universe the Art-Net values should be captured from.

Press [Rec] and the current state of the specified Universe will be recorded.

Press [Stop] to stop the recording.

Now change the Art-Net settings to the Universe on which you want to send out the recorded Art-Net values (do NOT press [Rec] again) and press [OK] or [Apply] at the bottom of the Item Properties dialog. Close this dialog and click on the Art-Net Recorder Button.

**[>] and [<]:**

With these two buttons you may browse through the recorded Art-Net sequence step by step.

**[Play]:**

Press [Play] to play the recorded Art-Net sequence.

**[Pause]:**

Press [Pause] to pause the recorded Art-Net sequence.

**[Rewind]:**

Press [Rewind] to bring the sequence to its Inpoint.

**[Loop]:**

Activate this checkbox and the Art-Net sequence will be looped instead of played once.

**In & Out:**

Here you may define an In- and Output different from the originally recorded sequence. To cut off 2 seconds from the beginning of the recording, enter "50" as inpoint (25 frames = 1 second).

**[DMX Link Out]:**

To play the recorded Universe via the DMX Link Out, activate this checkbox.

Please note that "DMX LINK Out" needs to be enabled in the [Connection Manager](#)<sup>1166</sup>.

**Button Style**

In the Button Style you may set up the button's text as well as its font and colour.

Three images can be assigned to the different states of the button.

"Release" refers to no click.

"Click" is on press.

"Highlight" can be used to draw a png with alpha over either the click or release image.

You may also set the Buttons Height and Width.

**Script**

In the Script section you may enter commands to be executed. You may use the drop-down list and the "Add" button or type directly in the text field. The topic [Script Language](#)<sup>1254</sup> explains this in more detail.

See here a list of all [commands](#)<sup>1260</sup>. To control the ArtNet Recorder via commands itself, please use [these ones](#)<sup>1320</sup>.

### 17.3.2.9 SCROLLER HORIZONTAL / VERTICAL

The Scroller is designed to change the X or Y position of assigned media files in your Pandoras Box project, so that you can scroll through a certain amount of pictures.



To edit the Scroller's parameters simply right-click on the desired Scroller control and choose the menu entry "Item Properties", press [ALT+P] whilst the mouse is hovering above it or double-click on it when being in the edit / move mode ([ALT+M]). The Scroller Property Dialog opens up.

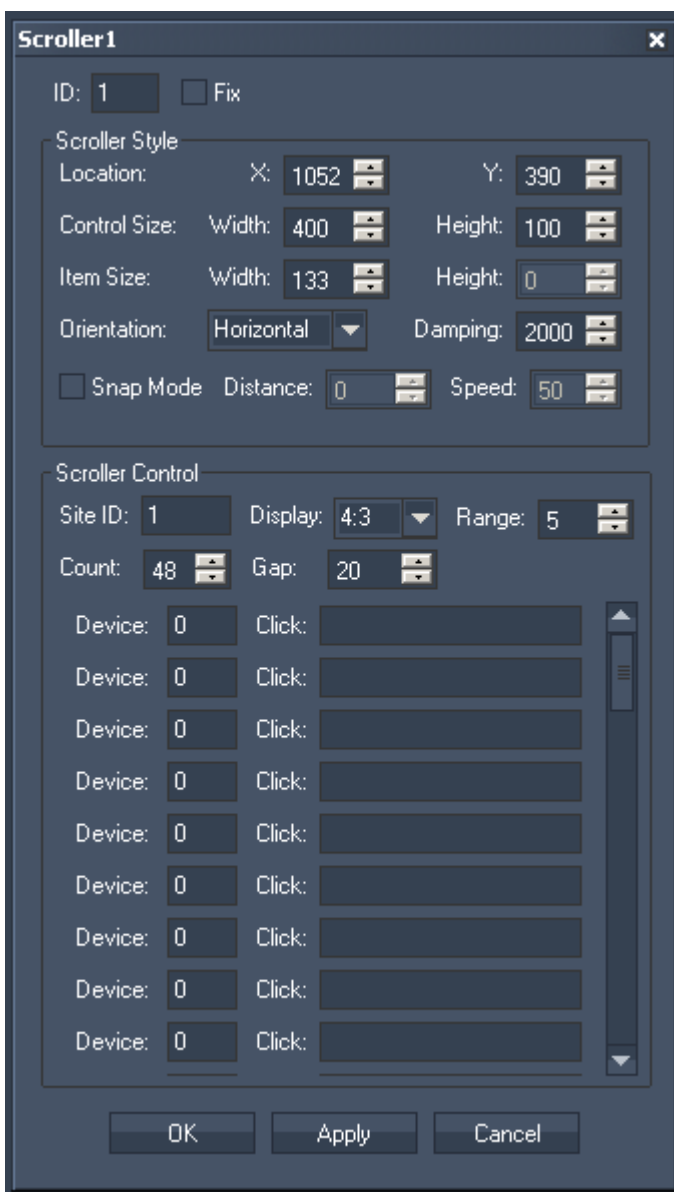

The property dialog is divided into two sections: the Scroller Style and the Scroller Control.

**ID:**

The Scroller's ID may be changed by entering a new one in the text field top left.

**Fix:**

When the option "Fix" is checked, the Scroller will be displayed on every page.

**Scroller Style**

**Location:**

To position the scroller enter here the Scroller's X and Y Position (in px) or move it manually with the mouse over the WD user interface when being in the edit / move mode [ALT+M].

**Control Size:**

To adjust the Scroller's size enter the desired values (in px) for Width and Height. Or scale the Scroller manually with the mouse at its corner down right when being in the edit / move mode [ALT+M].

**Item Size:**

Choose here how wide an item on the scroller should be. According to the width of the items you may see more or less items on the Scroller's interface. The Height of an item can't be influenced here – it always refers to the Height of the Scroller's Size itself. To adjust the Height please change the Height for the Control Size.

**Relation of the Control / Item Size and the layers in Pandoras Box:**

The size of an item influences the size of a layer inside Pandoras Box. To have a layer in Pandoras Box (that is controlled via an Scroller Item) covering the whole output, the Scroller size has to cover the whole Height of the WD interface. The Width of the Scroller does not necessarily have to cover the whole width of the WD interface as long as the Item's width gets the width resolution of the WD interface.

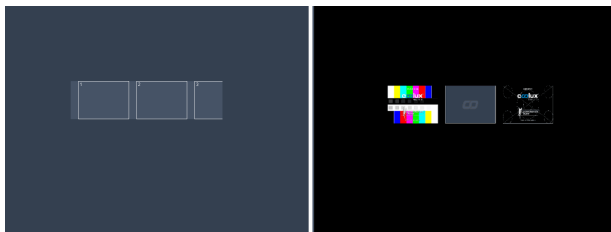

**Example 1:**

The Scroller in this example controls layers 1 through 3 in Pandoras Box. As you see the relation between the Scroller's size and the size of the whole WD interface is reflected in the Pandoras Box output.

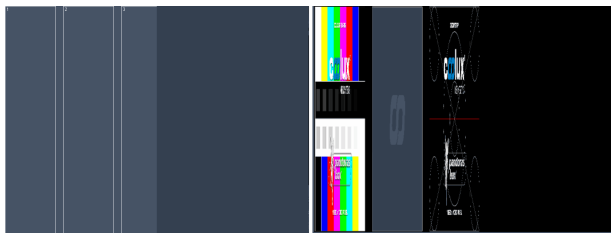

**Example 2:**

The Scroller's location is now set to X/Y = 0/0 and the Scroller's Height got the same Height the WD interface covers (without adjusting any width value). To bring the layer in Pandoras Box to aspect ratio, at least the Width of the Scroller's Items has to be adjusted to the Width of the WD interface, see next example.

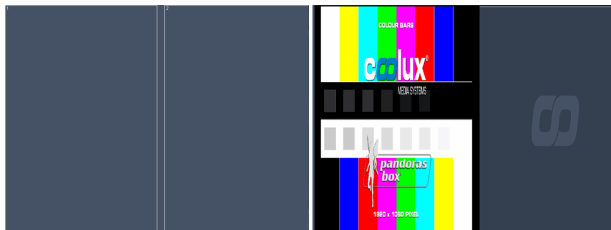

**Example 3a:**

The Scroller now covers the whole WD interface. The Item's Width is set to half of the Scroller's Width.

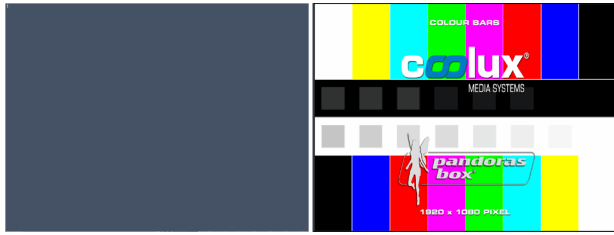

Example 3b:  
The Scroller covers the whole WD interface. The Item's Width is set to the Scroller's Width.

**Orientation:**

The Scroller can work horizontally and vertically, you may change its orientation here.

**Damping:**

The damping value influences the acceleration of the follow-up movement when the Scroller is released. The default value is set to 2000. The minimum value is 0 (no follow-up movement), the maximum value is 10000 (longest follow-up movement).

**Snap Mode**

Without the Snap Mode enabled the Items will be moved over the Scroller as far as you scroll the Scroller. When the Snap Mode is enabled and an Item is e.g.. moved about half of its width to the left, the Scroller will automatically go on scrolling until the next Item snaps at the Scroller's left border.

**--> Distance:**

The distance value (in px) defines how far you have to scroll the scroller until the snap mode snaps to the next Item. By default it is set to 0, so each small movement to the left or to the right will activate the snap mode to snap to the next Item to the left or to the right. If the distance is set to e.g.. the value 100, you have to scroll the scroller about 100 px to the left / right to let the snap mode snap to the next item to the left/right.

**--> Speed:**

The speed value defines how fast the scroller is scrolled to the next item when the snap mode is being activated: 100= max. speed, 1 = min. speed.

**Scroller Control**

**Site ID:**

Enter here the Site ID of the site in Pandoras Box the Scroller should be linked to.

**Display:**

Please choose here the aspect ratio of the Pandoras Box output. This is important to bring the layers in Pandoras Box to the correct aspect ratio, according to the Scroller Item sizes.

**Range:**

The range value defines how far a selected Scroller Item has to be moved in order to generate a click on it, see explanation under Device / Click. The default value is 5, that means that within moving the Item 5 pixels to the left / right the Item won't be clicked. This range function is useful not to activate an item by fault.

**Count:**

Set here the amount of Items visible in the Scroller and controllable in Pandoras Box.

**Gap:**

You may increase or decrease the gap between each Item by entering a new value (in px). It ranges from 0 (=no gap) up to 2048 (=max. gap).

**Device / Click:**

Set here the PB Layer ID (Device ID) which should be linked to each Item inside the Scroller.

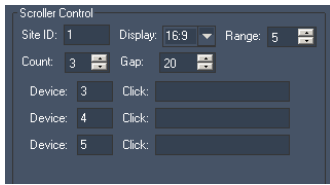

**Example:**

Here the Count is set to 3, so only 3 Items are visible inside the Scroller and only 3 layers in PB can be controlled through the Scroller Items.

The devices are set so that:  
 Item 1 controls Layer 3 of site 1,  
 Item 2 controls Layer 4 of site 1,  
 Item 2 controls Layer 5 of site 1.

To execute a command when an Item is clicked please enter the command in the Click text field. The topic [Script Language](#)<sup>1254</sup> explains commands and how to use them in more detail.

As these small text fields do not offer a good overview when using multiple commands, working with [macros](#)<sup>1191</sup> is a good option.

See here a list of all [commands](#)<sup>1260</sup>. To reset the Scroller via a command (bringing it back to display the first Item), please use the following one:

[WDSrollerReset.'ID'](#)<sup>1376</sup>

### 17.3.2.10 FLIPSWITCH HORIZONTAL / VERTICAL

The Flipswitch is designed to execute scripts only when the control reaches the specified unlock position.



To edit the Flipswitch's parameters simply right-click on the desired Flipswitch control and choose the menu entry "Item Properties", press [ALT+P] whilst the mouse is hovering above it or double-click on it when being in the edit / move mode ([ALT+M]). The Flipswitch Property Dialog opens up.



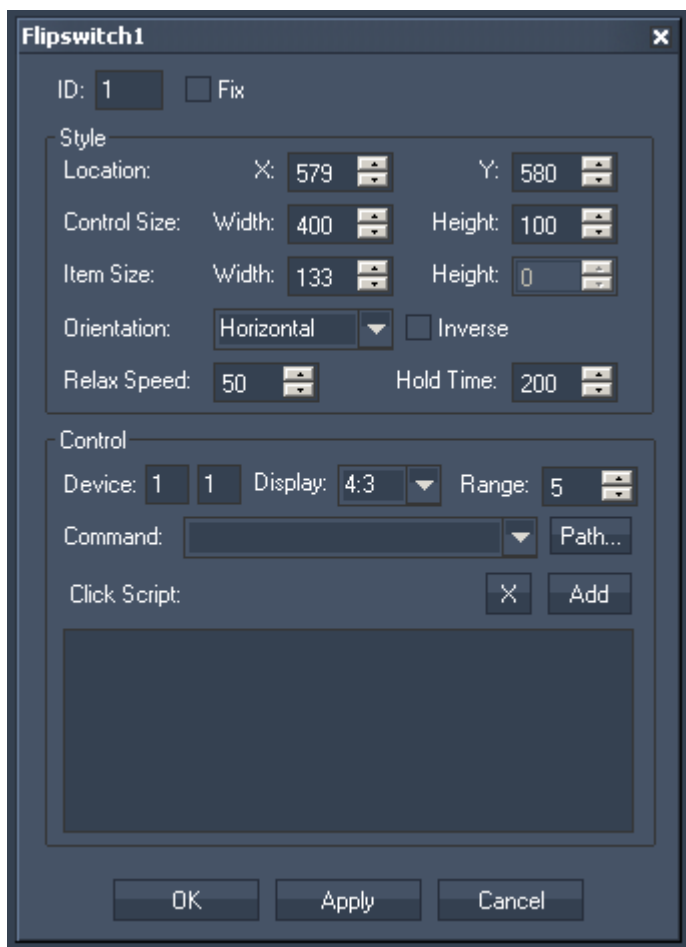

The property dialog is divided into two sections: Style and Control.

**ID:**

The Flipswitch's ID may be changed by entering a new one in the text field top left.

**Fix:**

When the option "Fix" is checked, the Flipswitch will be displayed on every page.

### Flipswitch Style

**Location:**

To position the Flipswitch enter here the Flipswitch 's X and Y Position (in px) or move it manually with the mouse over the WD user interface when being in the edit / move mode [ALT+M].

**Control Size:**

To adjust the Flipswitch's size enter the desired values (in px) for Width and Height. Or scale the Flipswitch manually with the mouse at its corner down right when being in the edit / move mode [ALT +M].

**Item Size:**

Choose here how wide the handle-item on the Flipswitch should be. The height of an the item can't be influenced here – it always refers to the Height of the Flipswitch's Size itself. To adjust the height please change the height for the Control Size.

**Relation of the Control / Item Size and the linked layer in Pandoras Box:**

The size of the handle item influences the size of the linked layer inside Pandoras Box. To have the layer in Pandoras Box (that is controlled via the handle item) covering the whole output, the Scroller size has

to cover the whole height of the WD interface. The width of the Scroller does not necessarily have to cover the whole width of the WD interface as long as the Item's width gets the width resolution of the WD interface.

#### Orientation:

The Flipswitch can work horizontally and vertically, you may change its orientation here.

#### Inverse:

Tick the check box to bring the Flipswitch Item to the opposite border of the Control.

#### Relax Speed:

The Relax Speed defines how fast the Flipswitch Item will move back to its default position after it was moved and the Click Script was NOT executed. The default value for the Relax Speed is 50. Decrease this value to get a slower move, increase it to quicken it.

#### Hold Time:

The Hold Time (in ms) defines how long the Item will stay on the position where the click script will be executed before it jumps back to its default position.

### Flipswitch Control

#### Device ID:

Set here the PB Layer ID (Device ID) which should be linked to the Flipswitch.

#### Example:

With the Device ID 1 | 1 the Layer 1.1 in PB will be controlled.

#### Display:

Please choose here the aspect ratio of the Pandoras Box output. This is important to bring the layers in Pandoras Box to the correct aspect ratio, according to the Flipswitch Item size.

#### Range:

The range value defines how far the Flipswitch Item has to be moved to the opposite border (in pixels). The default value is 5, that means that within moving the Item 5 pixels to the border opposite the Flipswitch Item the click script will be executed. This range function is useful to define how far the Flipswitch Item has to be moved to execute the script.

#### Click Script:

To execute a command when the Flipswitch Item is moved into the click-area, please enter the command in the Click Script field. You may use the drop-down list and the "Add" button or type directly in the text field. The topic [Script Language](#)<sup>1254</sup> explains this in more detail.

See here a list of all [commands](#)<sup>1260</sup>.

### 17.3.3 ANALOG CLOCK

Use this control to display the current time via an Analog Clock.



To edit the Analog Clock parameters simply right-click on the Analog Clock control and choose the menu entry "Item Properties", press [ALT+P] whilst the mouse is hovering above it or double-click on it when being in the edit / move mode ([ALT+M]). The Analog Clock Property Dialog opens up.



**ID:**  
The Analog Clock's ID may be changed by entering a new one in the text field top left.

**Fix:**  
When the option "Fix" is checked, the Analog Clock will be displayed on every page.

You may design your Analog Clock using different colors for Background, Center, Hours, Minutes, Seconds, Major Ticks, Minor Ticks and Labels.

Tick the check boxes to hide / display the mentioned units.

You may also label the clock by entering a name in the text field down left.

### 17.3.4 CUE LIST

Use this Cuelist control for Scripts with Jump Cues & Auto Follow Wait times.

The CueList Control allows you to create and control your own Cuelist which contains any kind of commands.

This might be a good choice if you want to execute a command which follow on other actions or commands but still to be able to control it by the buttons and commands at every time.

This type of programming is similar to the way lighting desks work.

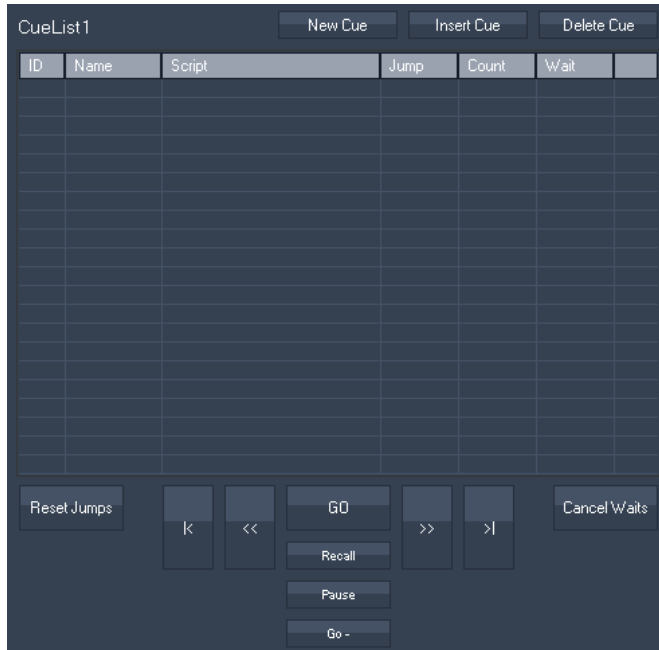

**[New Cue]:**  
Adds a new Cue at the end of the CueList.

**[Insert Cue]:**  
Adds a new Cue at the current position of the CueList. The ID gets a decimal number between the previous and the next Cue ID.

**[Delete Cue]:**  
Deletes the selected Cue in the CueList.

**Cue Parameter:**  
For every cue you may set a Script, a Jump, Count or Wait time. To do this please right-click into the desired text field, enter your text and press [ENTER]. All entries may be edited later on again, including Cue ID and Name.

**ID:**  
The Cuelist is sorted by the cue IDs. To reposition a Cue in the Cuelist, change its ID.

**Name:**  
The Cue's name is automatically set to Cue#, e.g. Cue2.

**Script:**  
Enter the command that should be executed. The topic [Script Language](#)<sup>1254</sup> explains this in more detail. See here a list of all [commands](#)<sup>1260</sup>.

**Jump:**

If you want to jump to a specific cue after the current one, enter the ID of the Cue to jump to. If this should happen endless, don't enter a count number!

**Count:**

If you want to limit the amount of jumps set a count value here. After this value is reached the jump won't be executed any more until you reset the jump count.

**Wait:**

Insert a wait time in seconds before the next Cue (or jump) is executed automatically. To abort the Wait time press [Cancel Waits].

**Cue Control:**

[Go]	starts the next Cue	( = <a href="#">WDCueListGo.'ID'</a> <sup>1324</sup> )
[Recall]	recalls the current Cue	( = <a href="#">WDCueListRecall.'ID'</a> <sup>1325</sup> )
[Pause]	pauses the Cuelist	( = <a href="#">WDCueListPause.'ID'</a> <sup>1324</sup> )
[Go-]	goes one step back in the Cuelist	( = <a href="#">WDCueListGo-.'ID'</a> <sup>1325</sup> )
[ <]	goes to first cue without executing it	( = <a href="#">WDCueListFirstCue.'ID'</a> <sup>1325</sup> )
[<<]	steps back cue by cue without executing it	( = <a href="#">WDCueListPrevCue.'ID'</a> <sup>1325</sup> )
[>>]	steps forward cue by cue without executing it	( = <a href="#">WDCueListNextCue.'ID'</a> <sup>1325</sup> )
[> ]	goes to the last cue without executing it	( = <a href="#">WDCueListLastCue.'ID'</a> <sup>1326</sup> )
[Reset Jumps]	set's the Counter back to zero	( = <a href="#">WDCueListResetJumps.'ID'</a> <sup>1326</sup> )
[Cancel Waits]	cancels the current Wait time but does not continue executing the Cuelist	( = <a href="#">WDCueListCancelWaits.'ID'</a> <sup>1326</sup> )

To edit the CueList parameters simply right-click on the CueList control and choose the menu entry "Item Properties", press [ALT+P] whilst the mouse is hovering above it or double-click on it when being in the edit / move mode ([ALT+M]). The CueList Property Dialog opens up.



**ID:**

The CueList's ID may be changed by entering a new one in the text field top left.

**Fix:**

When the option "Fix" is checked, the CueList will be displayed on every page.

**Seq:**

Enter here the ID of the sequence which should be controlled.

**Name:**

Enter here the CueList's name that will be displayed on top of the control.

**Editing Mode:**

When this option is disabled the Cues in the CueList can't be edited anymore.

**Loop CueList:**

If this option is checked the CueList will automatically be continued at the beginning when it reaches its end.

**Scripts:**

In the Script section you may enter commands to be executed. You may use the drop-down list and the "Add" button or type directly in the text field. The topic [Script Language](#)<sup>1254</sup> explains this in more detail. See here a list of all [commands](#)<sup>1260</sup>. [These ones](#)<sup>1324</sup> will let you control the cueList itself, e.g. through a [Custom Script Button](#)<sup>884</sup>.

### 17.3.5 DIGITAL CLOCK

Use this control to display the current time via a Digital Clock.



To edit the Digital Clock parameters simply right-click on the Digital Clock control and choose the menu entry "Item Properties", press [ALT+P] whilst the mouse is hovering above it or double-click on it when being in the edit / move mode ([ALT+M]). The Digital Clock Property Dialog opens up.

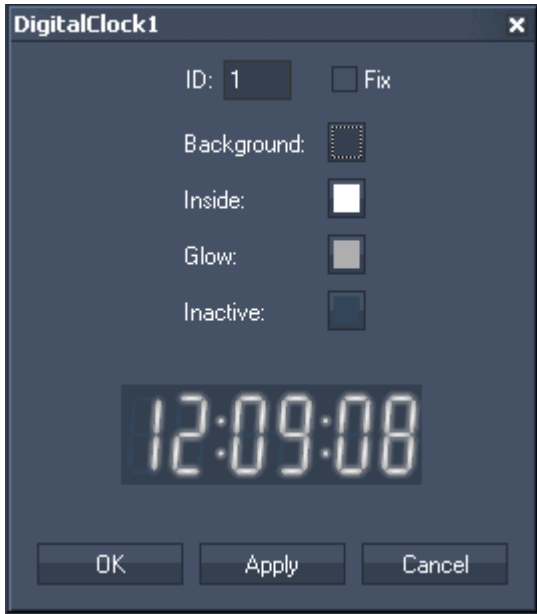

**ID:**

The Digital Clock's ID may be changed by entering a new one in the text field on the top.

**Fix:**

When the option "Fix" is checked, the Digital Clock will be displayed on every page.

You may design your Digital Clock using different colors for Background, Inside, Glow and Inactive.

## 17.3.6 DISPLAYS

### [Angular Display](#)<sup>912</sup>

The Angular Display allows showing any numeric value that is routed to the [Angular Display Output Node](#)<sup>1109</sup>.

### [Bar Graph](#)<sup>914</sup>

The Bar Graph allows showing any numeric value that is routed to the [Bar Graph Output Node](#)<sup>1111</sup>.

### [Digital Display](#)<sup>915</sup>

The Digital Display allows showing any numeric value that is routed to the [Digital Display Output Node](#)<sup>1114</sup>.

### [Motion Mask](#)<sup>916</sup>

The Motion Mask Display allows using a DirectShow Video input to create a soft motion-detected Mask. The MotionMask as well supports AirScan/Camera Point Tracker/Kinect & iPhone multi-touch input for mask painting.

### [Video Input Display](#)<sup>918</sup>

Use the Video Input Display displaying a video source on the WD user interface or to send a [Video Snapshot](#)<sup>893</sup> to Pandoras Box.

### 17.3.6.1 ANGULAR DISPLAY

The Angular Display allows showing any numeric value that is routed to the [Angular Display Output Node](#)<sup>1109</sup>.

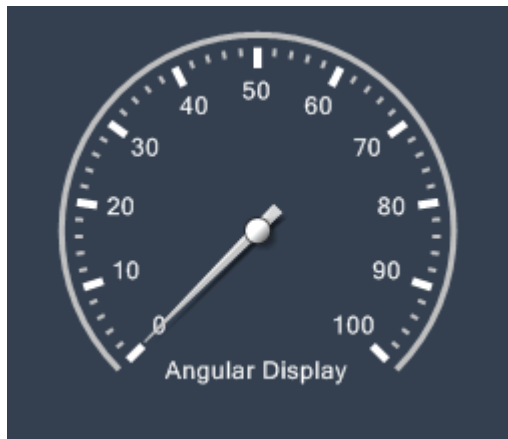

To set up the Angular Display's properties, simply right-click on the Angular Display and choose the menu entry "Item Properties", press [ALT+P] whilst the mouse is hovering above it or double-click on it when being in the edit / move mode ([ALT+M]). The Angular Display Property dialog opens up.



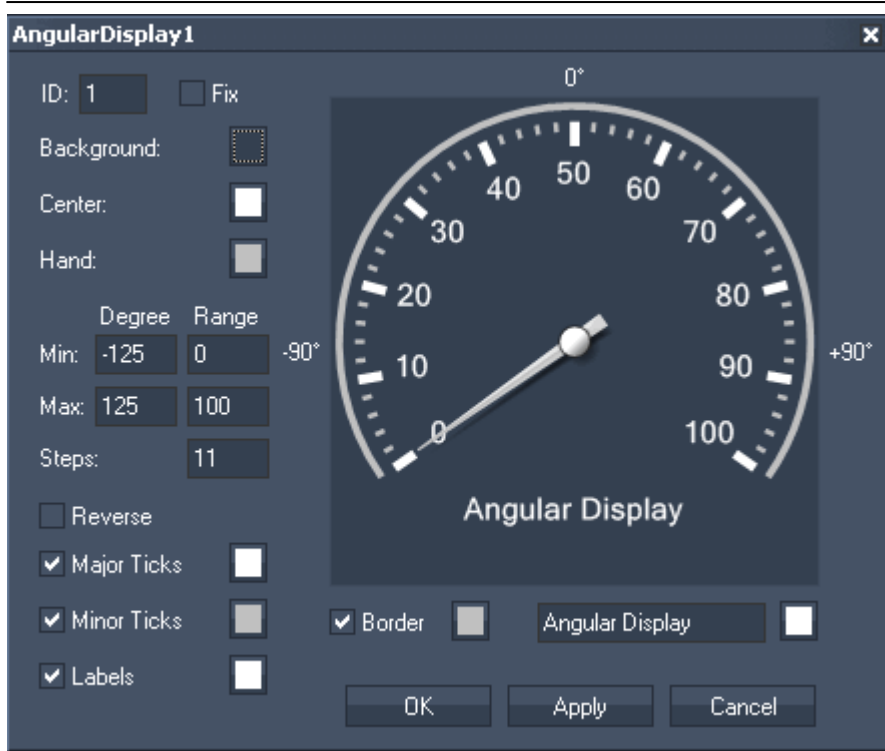

**ID:**

The Angular Display' ID may be changed by entering a new one in the text field top left.

**Fix:**

When the option "Fix" is checked, the Angular Display will be displayed on every page.

You may design your Angular Display using different colors for Background, Center and Hand.

Set Min and Max for Degree and Range to change the display's size and range. Enter the amount of steps for your range.

To flip the display, check "Reverse".

You may set different colors for Major Ticks, Minor Ticks, Labels and Border. Tick the check boxes to hide / display these options.

Tick the check boxes to hide / display Major Ticks, Minor Ticks, Labels and Border.

You may also label the display by entering a name in the text field down right.

### 17.3.6.2 BAR GRAPH

The Bar Graph allows showing any numeric value that is routed to the [Bar Graph Output Node](#)<sup>[1111]</sup>.

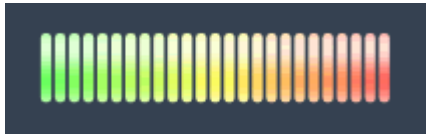

To set up the Bar Graph's properties, simply right-click on the Bar Graph and choose the menu entry "Item Properties", press [ALT+P] whilst the mouse is hovering above it or double-click on it when being in the edit / move mode ([ALT+M]). The Bar Graph Property dialog opens up.

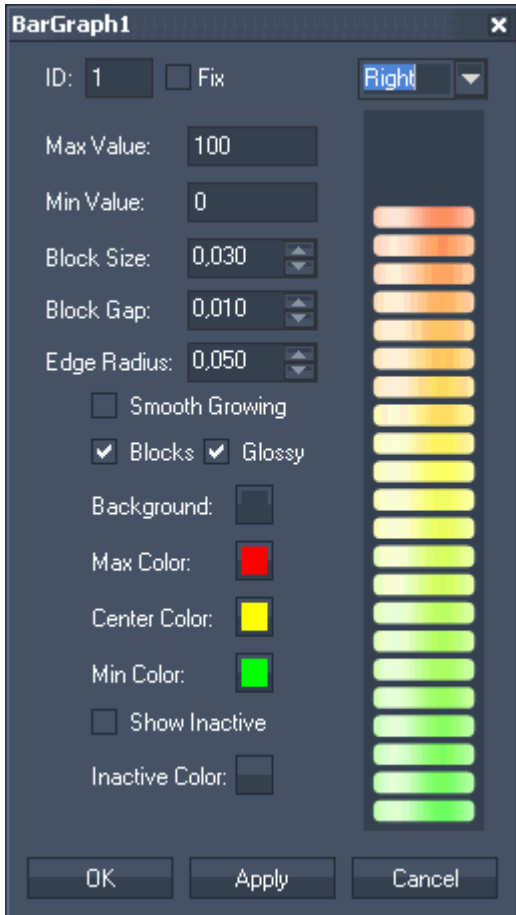

**ID:**

The Bar Graph's ID may be changed by entering a new one in the text field top left.

**Fix:**

When the option "Fix" is checked, the Bar Graph will be displayed on every page.

Set the orientation of the Bar Graph to up, down, left or right.

Enter the Maximum and Minimum Value that should be displayed. You may also want to edit the Block Size and Block Gap as well as the Edge Radius.

Design the Bar Graph for your own needs by choosing different type of colors (for background, Max-, Center- and Min Colour).

### 17.3.6.3 DIGITAL DISPLAY



The Angular Display allows to show any numeric value that is routed to the [Digital Display Output Node](#) <sup>1114</sup>.

To set up the Digital Display simply right-click on the display and choose the menu entry "Item Properties", press [ALT+P] whilst the mouse is hovering above it or double-click on it when being in the edit / move mode ([ALT+M]). The Digital Displays Property dialog opens up.

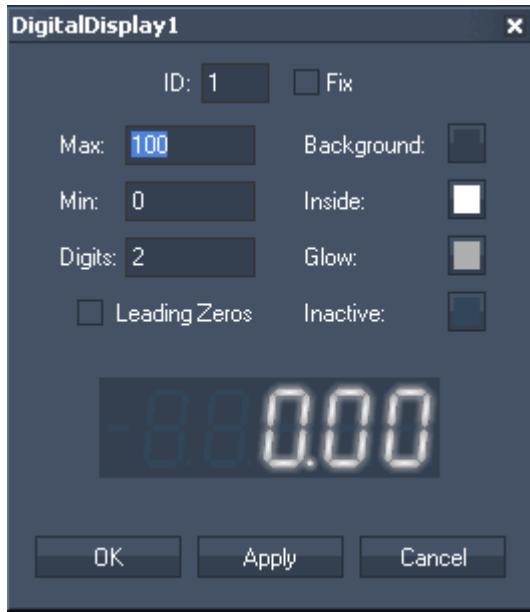

**ID:**  
The Digital Display's ID may be changed by entering a new one in the text field on the top .

**Fix:**  
When the option "Fix" is checked, the Digital Display will be displayed on every page.

Set the value range for incoming data using Max and Min. Enter the amount of digits.

The option "Leading Zeros" fills all empty digits with zeros if amount of digits is smaller than the maximum, e.g. "7" will be displayed as "007" if maximum value is set to 100.

You may design your Digital Display using different colors for Background, Inside, Glow and Inactive.

### 17.3.6.4 MOTION MASK

The Motion Mask Display allows to use a DirectShow Video input to create a soft motion-detected Mask. The MotionMask as well supports AirScan/Camera Point Tracker/Kinect & iPhone multi-touch input for mask painting

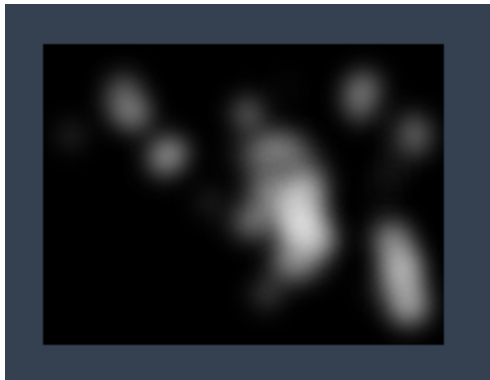

To set up the Motion Mask Display's simply right-click on the display and choose the menu entry "Item Properties", press [ALT+P] whilst the mouse is hovering above it or double-click on it when being in the edit / move mode ([ALT+M]). The Motion Mask Displays Property dialog opens up.

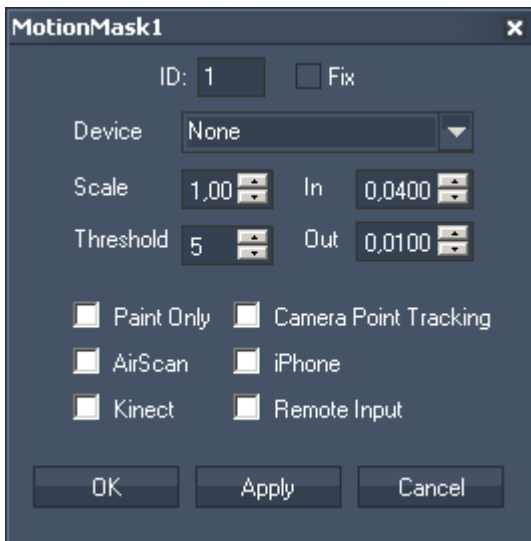

**ID:**

The Display's ID may be changed by entering a new one in the text field top left.

**Fix:**

When the option "fix" is checked, the Motion Mask will be available from every page.

**Device:**

Choose your DirectShow Video device from the list.

**Scale:**

The Scale is set to 100 by default. When decreasing this scale value the motion clouds get finer, when increasing it the motion clouds get softer.

**Threshold:**

This value defines how wide the movement in front of the camera has to be to be detected and displayed as motion cloud. Setting it down will detect smaller movements as well, setting it up will only detect wider movements.

**In:**

The In-value defines how soft the motion clouds will be displayed. The smaller this value is the softer the cloud comes in.

**Out:**

The Out-value defines how soft the motion clouds will disappear from the motion mask display. The smaller this value is the softer they disappear.

**Paint Only:**

Check this small box if you don't want the motion clouds to disappear after they have been displayed.

**Camera Point Tracking:**

Use this check box to enable / disable the Multipoint Input of the [Camera Point Tracking](#)<sup>1224</sup>.

**AirScan:**

Use this check box to enable / disable the Multipoint Input of the [AirScan](#)<sup>1155</sup>.

**iPhone:**

Use this check box to enable / disable the Multipoint Input of an [iPhone](#)<sup>1182</sup>.

**Kinect:**

Use this check box to enable / disable the Multipoint Input of the [Kinect](#)<sup>1162</sup>.

**Remote Input:**

Use this check box to enable / disable the Remote Input of another device. The input of a remote device needs to be enabled in the [Connection Manager](#)<sup>1166</sup>.

[These commands](#)<sup>1349</sup> will let you control the motion mask display from outside, e.g. by executing them through a Custom Script Button:

### 17.3.6.5 VIDEO INPUT DISPLAY

Use the Video Input Display to display a video source on the WD user interface or to send a [Video Snapshot](#)<sup>893</sup> to Pandoras Box.

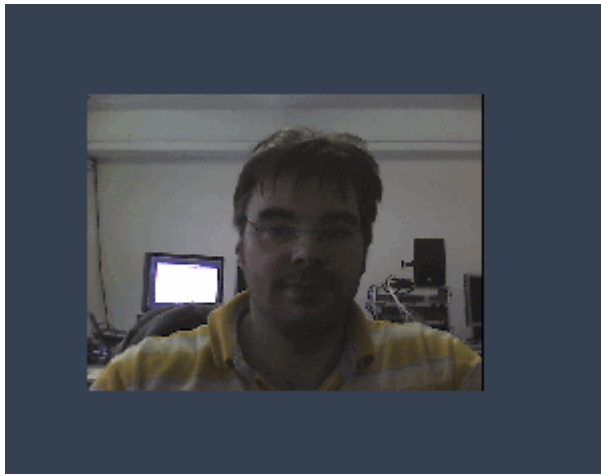

To set up the Video Input Display's simply right-click on the display and choose the menu entry "Item Properties", press [ALT+P] whilst the mouse is hovering above it or double-click on it when being in the edit / move mode ([ALT+M]). The Video Input Displays Property dialog opens up.

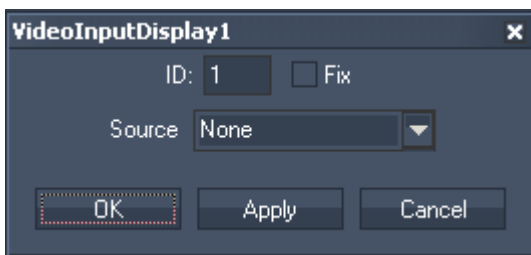

ID:

The Display's ID may be changed by entering a new one in the text field top left.

Fix:

When the option "Fix" is checked, the Video Input Display will be displayed on every page.

Choose a Video Source from the list.

### 17.3.7 DROP DOWN LIST



A Drop Down List is a control element that allows to select one value from a series of predefined options. First, the Drop Down List displays a single line, e.g. "Select a language". When the user clicks on the small down arrow, a list is displayed from which one entry can be chosen. Once this is done, Widget Designer displays the chosen value and in addition returns an internal index number. For the above depicted example, the operator gets the information that "French" and the index "1" has been chosen.

Note that the indexing starts with "0". Depending on this information further commands can be executed accordingly. For example, Widget Designer toggles to a certain page with French labels or Pandoras Box calls a cue with French content.

To create a Drop Down List choose "Create"->"Drop Down List". The mouse cursor changes to a crosshair icon, indicating the create mode. To create one or multiple Drop Down Lists just left-click anywhere on the empty main background window and you will see a new Drop Down List being assigned and displayed. Right-click to quit the create mode.

To edit the Drop Down List's parameters simply right-click on the desired Drop Down List and choose the menu entry "Item Properties", press [ALT+P] whilst the mouse is hovering above it or double-click on it when being in the edit / move mode ([ALT+M]). The DropDownList property dialog opens up.

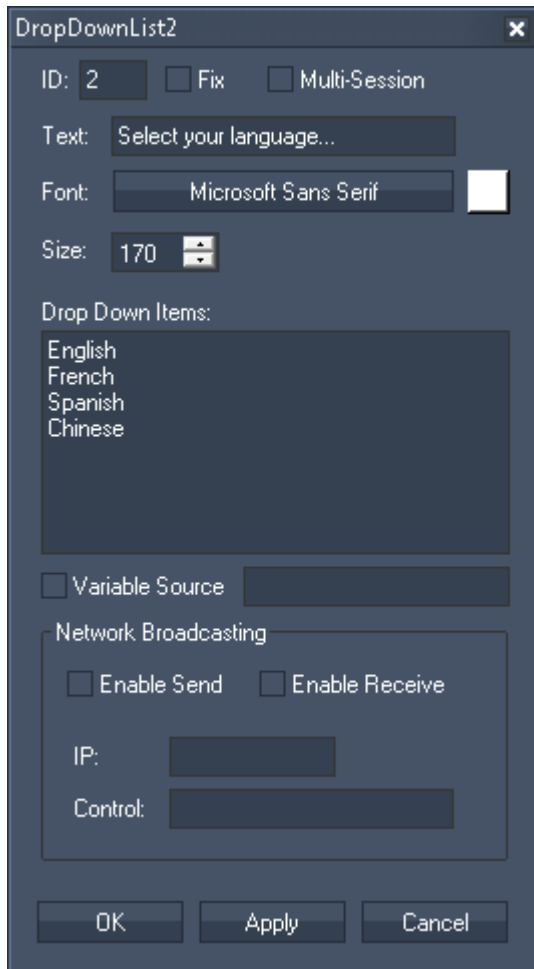

**ID:**  
The Drop Down List's ID may be changed by entering a new one.

**Fix:**  
When the option "Fix" is checked, the Drop Down List is available on every page.

**Multi-Session (WD ULT only):**  
When this option is checked, the Drop Down List can have different values according to each individual [Web Server](#)<sup>1177</sup> session. Note that this is only for users of WD ULT. The topic [Member Values](#)<sup>1196</sup> offers more information.

**Text:**  
Enter the text that is displayed per default before the Drop Down List is opened.  
To set this text back you can use the command `WDDropDownListSetText, ID, Text`

**Font and Color:**  
Pick a font setting and color for the displayed text including the Drop Down Items.

**Size:**  
Choose the width for the Drop Down List. The height adopts accordingly to the items and font settings.

**Drop Down Items:**  
Enter the items for the list to be displayed when the Drop Down List is opened with the down arrow.  
The "[Command List](#)<sup>1333</sup>" lists all available commands.

**Variable Source:**  
Check this option and enter the name from an existing array [variable](#)<sup>1193</sup>.

## Network Broadcasting

The NBS (Network Broadcast Service) allows transmitting and updating Faders, Labels and Custom Script Buttons etc. across multiple WD Designers instances on the network. To activate this service, please refer to the [Remoting dialog](#)<sup>1184</sup>

**Sending values:**

To send the Drop Down List's state as broadcast into the network, you only have to check "Enable Send".

**Receiving values:**

To receive values from other Drop Down Lists, please check "Enable Receive".

Now you have to specify which item should update your Drop Down List:

Enter the IP address of the computer you want to listen to. This could be the local computer (to control the Drop Down List through another Drop Down List on the same Widget Designer) or a different computer in the network. If you do not want to specify the computer but want to listen to all computers in the network, enter "255.255.255.255".

As next step specify the Drop Down List you want to take the status from. This could be e.g. "DropDown1" or "DropDown2".

**Programming with Drop Down Lists**

This is a short description how you can program with the Drop Down List.

First of all there is a [DropDownList Input node](#)<sup>999</sup> which can be used to forward the chosen text and index number to a following filter or output node.

Second, the Drop Down control returns member values, allowing for example the following script. Please find more information in the topic "[Member Values](#)"<sup>1196</sup>.

```
If DropDown1.Text = French
{
  Labell1.Text = Bonjour
}
```

Lastly, the "[Command List](#)"<sup>1333</sup> lists all available commands.

**17.3.8 EVENT VIEWER**

The Event Viewer allows you to monitor all events created with the [Event Tool](#)<sup>1188</sup>.

Time	Name	Pattern	Count	Start	End
10.03.2010 08:00:00	Start Show	Every Hour	End Date	10.03.2010 08:00:00	10.03.2010 18:00:00
10.03.2010 09:00:00	Start Show	Every Hour	End Date	10.03.2010 08:00:00	10.03.2010 18:00:00
10.03.2010 10:00:00	Start Show	Every Hour	End Date	10.03.2010 08:00:00	10.03.2010 18:00:00
10.03.2010 11:00:00	Start Show	Every Hour	End Date	10.03.2010 08:00:00	10.03.2010 18:00:00
10.03.2010 12:00:00	Start Show	Every Hour	End Date	10.03.2010 08:00:00	10.03.2010 18:00:00
10.03.2010 13:00:00	Start Show	Every Hour	End Date	10.03.2010 08:00:00	10.03.2010 18:00:00
10.03.2010 14:00:00	Start Show	Every Hour	End Date	10.03.2010 08:00:00	10.03.2010 18:00:00
10.03.2010 15:00:00	Start Show	Every Hour	End Date	10.03.2010 08:00:00	10.03.2010 18:00:00
10.03.2010 16:00:00	Start Show	Every Hour	End Date	10.03.2010 08:00:00	10.03.2010 18:00:00
10.03.2010 17:00:00	Start Show	Every Hour	End Date	10.03.2010 08:00:00	10.03.2010 18:00:00
10.03.2010 18:00:00	Start Show	Every Hour	End Date	10.03.2010 08:00:00	10.03.2010 18:00:00

To see the events on different dates, please choose a date from the drop-down list on the top.



### 17.3.9 FADER CONTROLS

A fader can be created to control Pandoras Box device parameters or sequence parameters.

Choose between four kinds of faders:

[Colour Picker](#)<sup>921</sup>

[Encoder](#)<sup>922</sup>

[Fader Vertical / Horizontal](#)<sup>925</sup>

[Wheel Vertical / Horizontal](#)<sup>928</sup>

#### 17.3.9.1 COLOUR PICKER

The Colour picker allows you to choose a RGB / CMY colour and its brightness. The values of this RGB / CMY colour can be transferred to the Colour FX faders on a layer in Pandoras Box.

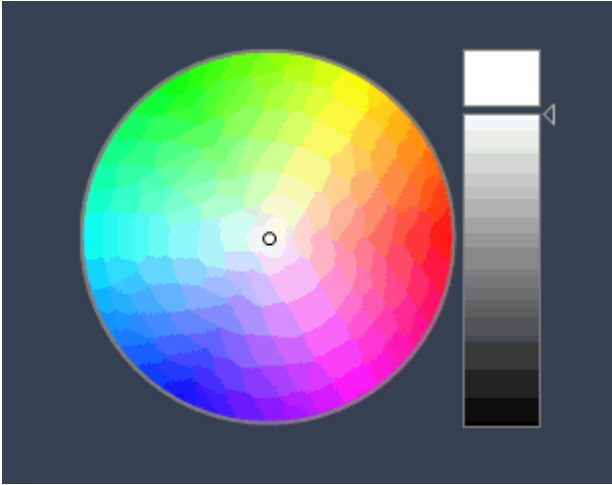

To edit the Colour Picker parameter simply right-click on the Colour Picker control and choose the menu entry "Item Properties", press [ALT+P] whilst the mouse is hovering above it or double-click on it when being in the edit / move mode ([ALT+M]).The Colour Picker property dialog opens up.

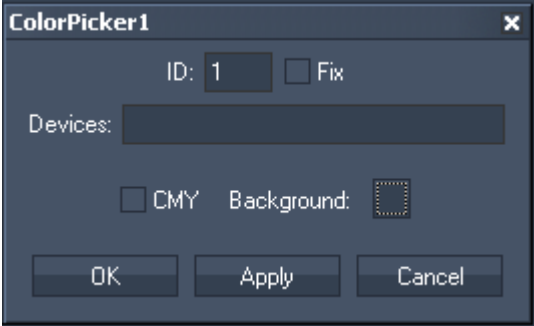

**ID:**

The Colour Picker’s ID may be changed by entering a new one in the text field on the top.

**Fix:**

When the option “Fix” is checked, the Colour Picker will be displayed on every page.

**Devices:**

Enter single or multiple devices the Colour Picker should effect. Separate multiple devices with a space character.

Use a comma or period to delimit the site from a layer ID.

Single entry: 1,1 or 1.1

Multiple entries: 1.1 1.2 1.3

### 17.3.9.2 ENCODER

An Encoder can be created to control Pandoras Box device parameters or a sequence opacity.



To create an encoder right-click anywhere on the empty main background window and go to "Create"->"Fader Controls"->"Encoder".

Once you have clicked on the last menu item the mouse cursor will change to a crosshair icon. This icon tells you that you are in the create mode.

To create one or multiple encoders just left click anywhere on the empty main background window and you will see a new encoder being assigned and displayed.

The encoder may now be clicked on and rotated left or right.

Now you will need to set up the properties of the newly built encoder control.

To edit the encoder's parameters simply right-click on the desired encoder control and choose the menu entry "Item Properties", press [ALT+P] whilst the mouse is hovering above it or double-click on it when being in the edit / move mode ([ALT+M]). The encoder property dialog opens up.

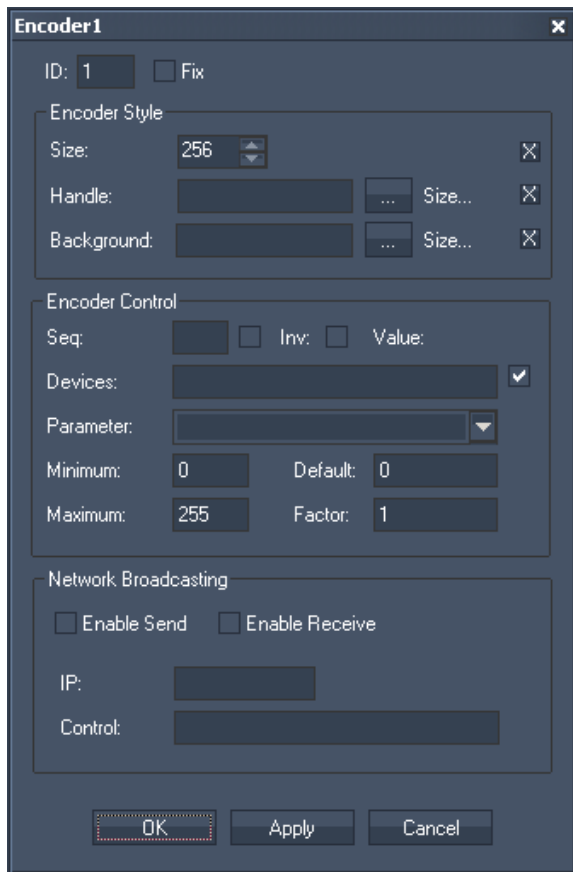

**ID:**

The Encoder's ID may be changed by entering a new one in the text field top left.

**Fix:**

When the option "Fix" is checked, the Encoder will be displayed on every page.

The Encoder Property dialog is divided into three sections:

**Encoder Style**

In the Encoder Style section you can set the size of the control as well as defining custom images to be used for the encoder's background and handle.

**Encoder Control**

The Encoder Control section lets you choose to either control Pandoras Box sequences (Sequence Opacity) or devices (any parameter of a layer).

To change from sequence to device control mode, simply check the check box next to the device text field.

To control one or multiple devices please enter the according site and device ID of the layers you would like to control with this fader.

For example: To control Layer 1 of Server 1 and 2 please enter "1.1 2.1" in the device text field

Next choose any parameter from the drop-down list to define which parameters to be controlled by the fader. If the parameter list does not show the desired parameter (in case that you use a custom device) simply type in the name of the parameter here.

Please note:

As from PB Version 5 on the parameters as well as their value ranges changed, make sure that you have chosen the correct version of the PB Master Device in the [IP configuration](#)<sup>865</sup>! The encoders support double precision values now.

If you want to create encoders that control more than one parameter at once, you may also enter multiple parameter names in the parameter drop-down list.

For example: To control xyz scale with one fader please enter "X SCALE,Y SCALE,Z SCALE"

To define the exact value ranges of the encoder you may want to change or enter your desired value in the minimum and maximum fields.

The default value represents the start value of the encoder and the invert check box allows you to change the direction of the encoder.

The factor is set to 1 by default. If you increase this value e.g. to 2, the encoder will increase / decrease its value twice as high with the same rotation.

Please note: When you are in the sequence mode, currently only the opacity of one sequence can be controlled.

## Network Broadcasting

The NBS (Network Broadcast Service) allows to transmit and update Faders, Labels and Custom Script Buttons across multiple WD Designers instances on the network.

To activate this service, please refer to the [IP Configuration](#)<sup>865</sup>!

Sending values:

To send the encoders values as broadcast into the network, you only have to check "Enable Send".

Receiving values:

To receive values from other encoders, please check "Enable Receive".

Now you have to specify which item should update your encoder:

Enter the IP address of the computer you want to listen to. This could be the local computer (to control the encoder through another item on the same Widget Designer) or a different computer in the network. If you do not want to specify the computer but want to listen to all computers in the network, enter "255.255.255.255".

As next step specify the item you want to take the values from. This could e.g. be "Encoder1" or "Encoder2"

Once all values are set, the encoder is ready to be used or edited at any time.

If you want to control the Encoder i.e. via a Custom Script Button, [these commands](#)<sup>1333</sup> are available:

XYPanel now under Panels!

### 17.3.9.3 FADER VERTICAL / HORIZONTAL



A fader can be created to control Pandoras Box device parameters or a sequence opacity.

To create a fader right-click anywhere on the empty main background window and go to "Create"->"Fader"->"Vertical".

Once you have clicked on the last menu item the mouse cursor will change to a crosshair icon. This icon tells you that you are in the create mode.

To create one or multiple faders just left click anywhere on the empty main background window and you will see a new fader being assigned and displayed.

The fader may now be clicked on and moved up and down.

Now you will need to set up the properties of the newly built fader control.

To edit the fader's parameters simply right-click on the desired fader control and choose the menu entry "Item Properties", press [ALT+P] whilst the mouse is hovering above it or double-click on it when being in the edit / move mode ([ALT+M]). The Fader Property dialog opens up.

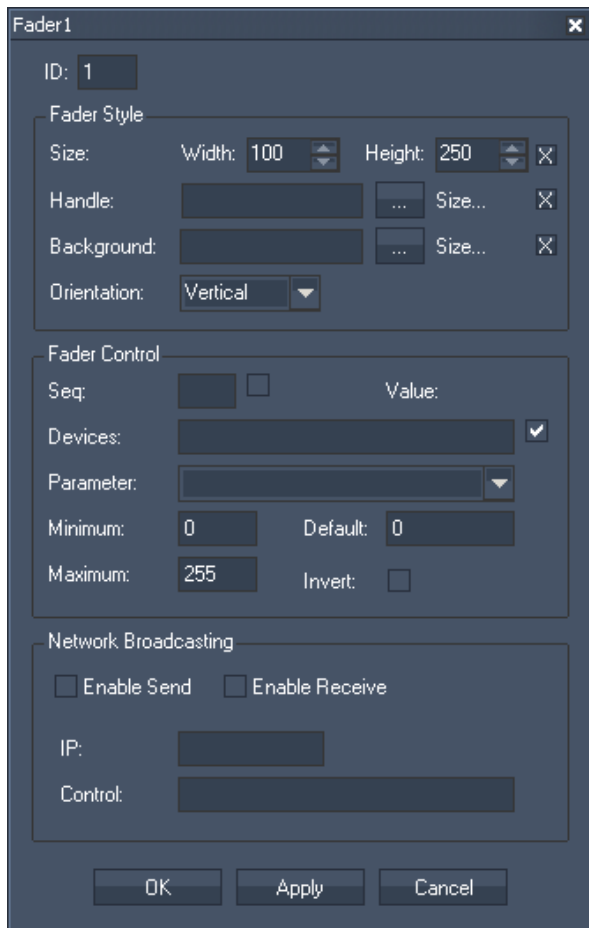

[ID]

The Fader's ID may be changed by entering a new one in the text field top left.

The Fader Property dialog is divided into three sections:

### Fader Style

In the Fader Style section you can set the size of the control as well as defining custom images to be used for the fader's background and handle. The orientation can also be changed from vertical to horizontal.

### Fader Control

The Fader Control section lets you choose to either control Pandoras Box sequences or devices (layers).

To change from sequence to service control mode, simply check the check box next to the device text field.

To control one or multiple devices please enter the according site and device ID of the layers you would like to control with this fader.

For example: To control Layer 1 of Server 1 and 2 please enter "1.1 2.1" in the device text field

Next choose any parameter from the drop-down list to define which parameters to be controlled by the fader. If the parameter list does not show the desired parameter (in case that you use a custom device) simply type in the name of the parameter here.

Please note:

As from PB Version 5 on the parameters as well as their value ranges changed, make sure that you have chosen the correct version of the PB Master Device in the [IP configuration](#)<sup>865</sup>! The fader support double precision values now.

If you want to create faders that control more than one parameter at once, you may also enter multiple parameter names in the parameter drop-down list.

For example: To control xyz scale with one fader please enter "X SCALE,Y SCALE,Z SCALE"

To define the exact value ranges of the fader you may want to change or enter your desired value in the minimum and maximum fields.

The default value represents the start value of the fader and the invert check box allows you to change the direction of the fader.

Please note: When you are in the sequence mode, currently only one sequence can be controlled.

## Network Broadcasting

The NBS (Network Broadcast Service) allows to transmit and update Faders, Labels and Custom Script Buttons across multiple WD Designers instances on the network.

To activate this service, please refer to the [IP Configuration](#)<sup>865</sup>!

Sending values:

To send the faders values as broadcast into the network, you only have to check "Enable Send".

Receiving values:

To receive values from other faders, please check "Enable Receive".

Now you have to specify which item should update your fader:

Enter the IP address of the computer you want to listen to. This could be the local computer (to control the fader through another item on the same Widget Designer) or a different computer in the network. If you do not want to specify the computer but want to listen to all computers in the network, enter "255.255.255.255".

As next step specify the item you want to take the values from. This could e.g. be "Fader1" or "Fader2"

Once all values are set, the fader is ready to be used or edited at any time.

### 17.3.9.4 WHEEL VERTICAL / HORIZONTAL

A Wheel can be created to control Pandoras Box device parameters or the sequence opacity.



To create a wheel right-click anywhere on the empty main background window and go to "Create"->"Fader Controls"->"Wheel Vertical" or "Wheel Horizontal".

Once you have clicked on the last menu item the mouse cursor will change to a crosshair icon. This icon tells you that you are in the create mode.

To create one or multiple wheels just left click anywhere on the empty main background window and you will see a new wheel being assigned and displayed.

The wheel may now be clicked on and moved up and down.

Now you will need to set up the properties of the newly built wheel control.

To edit the wheel's parameters simply right-click on the desired wheel control and choose the menu entry "Item Properties", press [ALT+P] whilst the mouse is hovering above it or double-click on it when being in the edit / move mode ([ALT+M]). The encoder property dialog opens up.

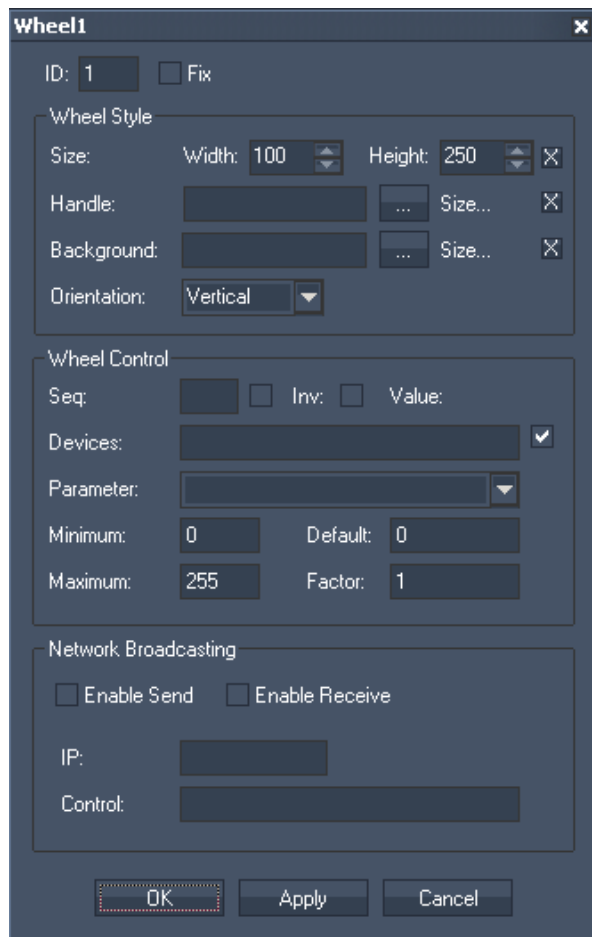

**ID:**

The Wheel's ID may be changed by entering a new one in the text field top left.

**Fix:**

When the option "Fix" is checked, the Wheel will be displayed on every page.

The Wheel Property dialog is divided into three sections:



## Wheel Style

In the Wheel Style section you can set the size of the control as well as defining custom images to be used for the wheel's background and handle.

## Wheel Control

The Wheel Control section lets you choose to either control Pandoras Box sequences (Sequence Opacity) or devices (any parameter of a layer).

To change from sequence to device control mode, simply check the check box next to the device text field.

To control one or multiple devices please enter the according site and device ID of the layers you would like to control with this fader.

For example: To control Layer 1 of Server 1 and 2 please enter "1.1 2.1" in the device text field

Next choose any parameter from the drop-down list to define which parameters to be controlled by the fader. If the parameter list does not show the desired parameter (in case that you use a custom device) simply type in the name of the parameter here.

### Please note:

As from PB Version 5 on the parameters as well as their value ranges changed, make sure that you have chosen the correct version of the PB Master Device in the [IP configuration](#)<sup>865</sup>! The wheels support double precision values now.

If you want to create wheels that control more than one parameter at once, you may also enter multiple parameter names in the parameter drop-down list.

For example: To control xyz scale with one fader please enter "X SCALE,Y SCALE,Z SCALE"

To define the exact value ranges of the wheel you may want to change or enter your desired value in the minimum and maximum fields.

The default value represents the start value of the wheel and the invert check box allows you to change the direction of the wheel.

The factor is set to 1 by default. If you increase this value e.g. to 2, the wheel will increase / decrease its value twice as high with the same movement.

Please note: When you are in the sequence mode, currently only the opacity of one sequence can be controlled.

## Network Broadcasting

The NBS (Network Broadcast Service) allows to transmit and update Faders, Labels and Custom Script Buttons across multiple WD Designers instances on the network.

To activate this service, please refer to the [IP Configuration](#)<sup>865</sup>!

Sending values:

To send the wheel's values as broadcast into the network, you only have to check "Enable Send".

Receiving values:

To receive values from other wheels, please check "Enable Receive".

Now you have to specify which item should update your wheel:

Enter the IP address of the computer you want to listen to. This could be the local computer (to control the encoder through another item on the same Widget Designer) or a different computer in the network. If you do not want to specify the computer but want to listen to all computers in the network, enter "255.255.255.255".

As next step specify the item you want to take the values from. This could e.g. be "Wheel1" or "Wheel2"

Once all values are set, the encoder is ready to be used or edited at any time.

If you want to control the Wheel i.e. via a Custom Script Button, [these commands](#)<sup>1390</sup> are available:

### 17.3.10 IMAGE / PICTURE BOX

The Picture Box control lets you add images on your user interface.

To edit the Image parameters simply right-click on the desired Image control and choose the menu entry "Item Properties", press [ALT+P] whilst the mouse is hovering above it or double-click on it when being in the edit / move mode ([ALT+M]). The Image Property Dialog opens up.

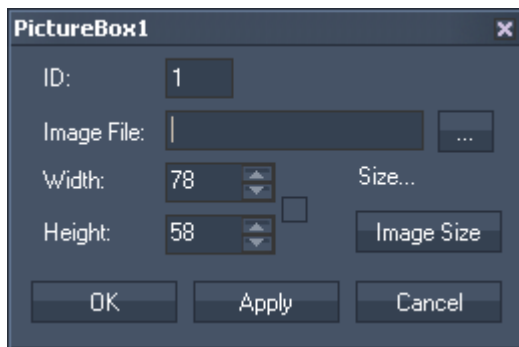

The Image's ID may be changed by entering a new one in the text field top left.

In the property dialog of the Image you assign a jpg, png or bitmap from your local hard drive.

Once the image is loaded you can change the size.

Use the check box to lock the aspect ratio between width and height.

The files native resolution can be assigned by clicking "Image Size"

Please note:

Up from WD Version 201 the control was renamed from "Image" to "PictureBox".

### 17.3.11 LABEL

The Label control lets you add text labels to your user interface.



To edit the Label parameters simply right-click on the desired Label control and choose the menu entry "Item Properties", press [ALT+P] whilst the mouse is hovering above it or double-click on it when being in the edit / move mode ([ALT+M]). The Label Property Dialog opens up.

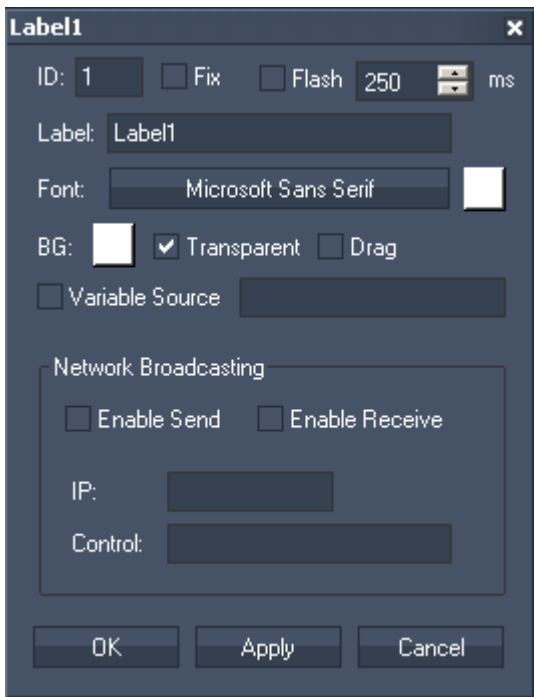

**ID:**  
The Label's ID may be changed by entering a new one in the text field top left.

**Fix:**  
When the option "Fix" is checked, the Label will be displayed on every page.

**Flash:**  
When this option "Flash" is checked, the label will flash (visible / not visible). The flash interval time is set to 250 ms by default. To increase or decrease the flashing interval time, change the value here or use the command `WDLLabelFlashInterval.'ID','Value'`<sup>1344</sup>.

**Label:**  
Edit the label text by entering it in the text field.

**Font:**  
Edit the label font and the font size by clicking on the button with the current font.

To change the label text colour click in the small box on the right side.

BG:

The background colour is transparent by default. If you want to underlay the text with a colour, uncheck “Transparent” and choose a colour for the background by clicking in the small box.

Variable Source:

If the value of a [variable](#)<sup>1193</sup> should be displayed as label text, check the option “Variable Source” and enter the name of the variable. If the variable’s value is going to be updated, the label text will be updated as well.

### Network Broadcasting

The NBS (Network Broadcast Service) allows to transmit and update Faders, Labels and Custom Script Buttons across multiple WD Designers instances on the network.

To activate this service, please refer to the [IP Configuration](#)<sup>865</sup>!

Sending values:

To send the labels values as broadcast into the network, you only have to check “Enable Send”.

Receiving values:

To receive values from other faders, labels or Custom Script Buttons, please check “Enable Receive”.

Now you have to specify which item should update your label:

Enter the IP address of the computer you want to listen to. This could be the local computer (to control the fader through another item on the same Widget Designer) or a different computer in the network. If you do not want to specify the computer but want to listen to all computers in the network, enter “255.255.255.255”.

As next step specify the item you want to take the values from. This could be a fader (e.g. “Fader1” or “Fader2”), a label (e.g. “Label1” or “Label2”), or a Custom Script Button (e.g. “CustomScript1” or “CustomScript2” – you will be able get its status: 1/0).

### 17.3.12 LIST VIEW

	A [1]	B [2]	C [3]	D [4]	E [5]	F [6]	G [7]	H [8]	I [9]	J [10]
1										
2										
3										
4										
5										
6										
7										
8										
9										
10										

	A [1]	B [2]	C [3]
1	Data1	Data2	Data3
2	1.3	2.4	0.7
3	5.9	1.8	4.4
4	7.8	0.2	4.9
5	4.1	6.1	8.2

A List View is a control element that displays data in a table with rows and columns. To fill the List View with a new database, you can either import it from other sources (e.g. Microsoft Excel) or create it in

Widget Designer. Furthermore in WD, you can edit every cell, add new rows or columns, or use one of the offered WD table operations. You can use the cell values for your Widget Designer programming, e.g. through variables.

To create a List View choose "Create"->"List View". The mouse cursor changes to a crosshair icon, indicating the create mode. To create one or multiple List Views just left-click anywhere on the empty main background window and you will see a new List View being assigned and displayed. Right-click to quit the create mode.

To edit the List View's parameters simply right-click on the desired List View and choose the menu entry "Item Properties", press [ALT+P] whilst the mouse is hovering above it or double-click on it when being in the edit / move mode ([ALT+M]). The ListView property dialog opens up.

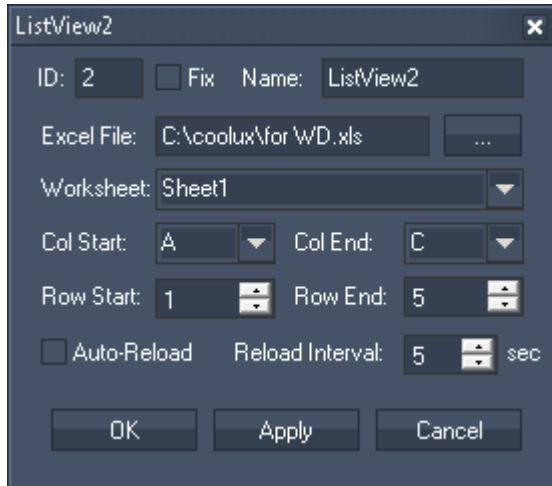

**ID:**  
The List View's ID may be changed by entering a new one.

**Fix:**  
When the option "Fix" is checked, the List View is available on every page.

**Name:**  
Enter a new name to be displayed above the List View.

**Column Names:**  
The command `WDLListViewSetColumnName, ID, - Col, Name` lets you assign name for columns.

**Excel File and Worksheet:**  
In case you like to import an existing database from an Excel Sheet, enter the path (or select one with the [...] button) and select one of the loaded names from the sheets. Please note that the file must be saved from Microsoft Excel as an \*.xls file!

As an alternative to the xls-format, you can use the command `WDLListViewLoadCSVFile, ID, - FileName, Separator` to import data from a csv-file.

**Col / Row Start and End:**  
Pick the start and end column and row if you like to import a Excel Sheet.

**Auto-Reload and Reload Interval:**  
If you would like to update your database in a certain interval, check the option "Auto-Reload" and enter the time in seconds after which your data is updated. Please note, that the Excel Sheet must be saved under the same path.

## Programming with List Views

This is a short description how you can program with a List View.

There are commands available that write a value, or set another property from a List View. The description of all [WDLListView... commands](#)<sup>1344</sup> is included in the command list.

If you like to manually edit a cell value, simply right-click into the cell and enter the new value into the small text field.

In addition there are various commands that read a value (or column/row) and write it into a(n array) variable. Further, WD offers operations that calculate the sum or average from a column or row. Again, the detailed description of all [VGetListView... commands](#)<sup>1260</sup> is included in the command list.

Last, the List View control offers member values, allowing for example the following script. Please find more information in the topic "[Member Values](#)"<sup>1196</sup>.

```
Listview1.Cell.1.1 = 1  
Listview1.Cell.1.1 = var2  
Listview1.Cell.1.1 = Math[6/2]
```

```
var3 = Listview1.Cell.1.1
```

### 17.3.13 PANEL

See here the available panel types:

[Drawing Canvas](#)<sup>935</sup>

[MultiTouch Panel](#)<sup>936</sup>

[XY Panel](#)<sup>948</sup>

### 17.3.13.1 DRAWING CANVAS

The Drawing Canvas lets you draw with the mouse. It can be used as creative item on the WD interface on the one hand. But the more interesting feature is to use it as live input in Pandoras Box, so that you will be able to paint on screen from within Widget Designer.

Please note that a Direct Show capture device like the coolux DVI capture card needs to be installed on the Pandoras Box server/player in order to use it as live picture / mask.

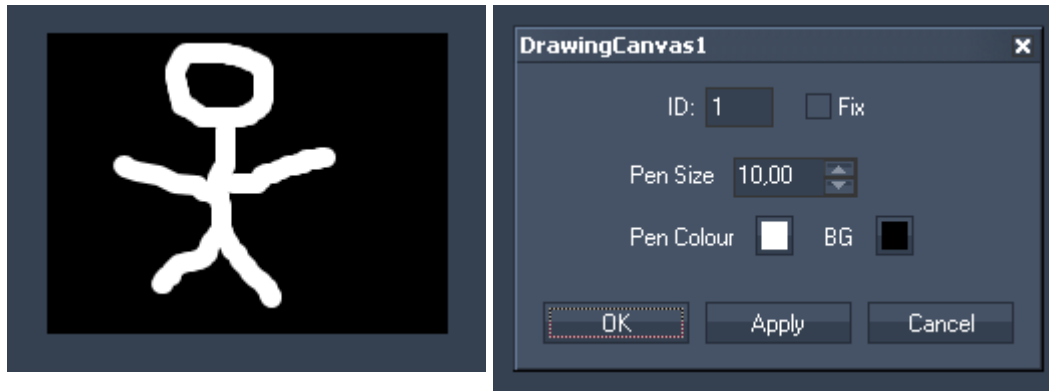

#### Item Properties:

To design the Pen and Background colors simply right-click on the Drawing Canvas control and choose the menu entry "Item Properties", press [ALT+P] whilst the mouse is hovering above it or double-click on it when being in the edit / move mode ([ALT+M]). The item property dialog opens up.

#### ID:

The Panel's ID may be changed by entering a new one in the text field top left.

#### Fix:

When the option "Fix" is checked, the Drawing Canvas will be available on every page.

#### Pen Size:

Choose here a different pen size by entering it or by using the arrows up and down.

#### Pen Colour:

You may change the pen colour by clicking in the small colored box. A new window opens where fixed colors or user defined ones are available.

#### BG:

You may change the background colour by clicking in the small colored box. A new window opens where fixed colors or user defined ones are available.

#### Clearing the drawing Canvas interface

To remote control the Drawing Canvas with commands e.g. in a Custom Script Button, [these ones](#)<sup>1332</sup> are available:

### 17.3.13.2 MULTITOUCH

The MultiTouch Panel allows direct control of up to 48 layers in PB as interactive touch surfaces.

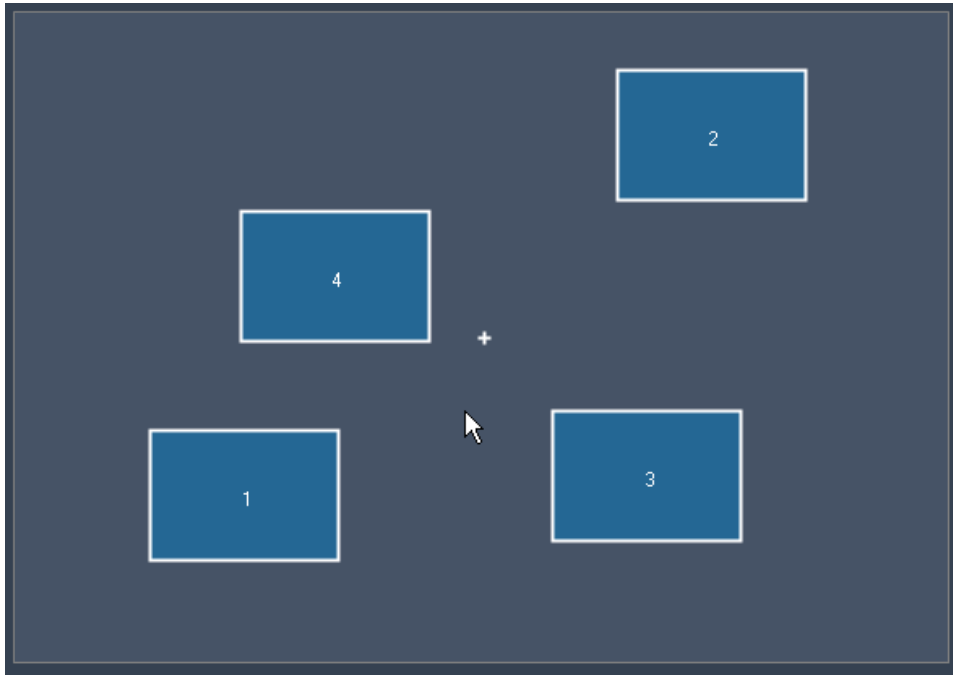

Any changes done to these items in the MultiTouch Panel (in the example above numbered 1-4), like moving, scaling or rotating them will be applied to the Layers in Pandoras Box as well:

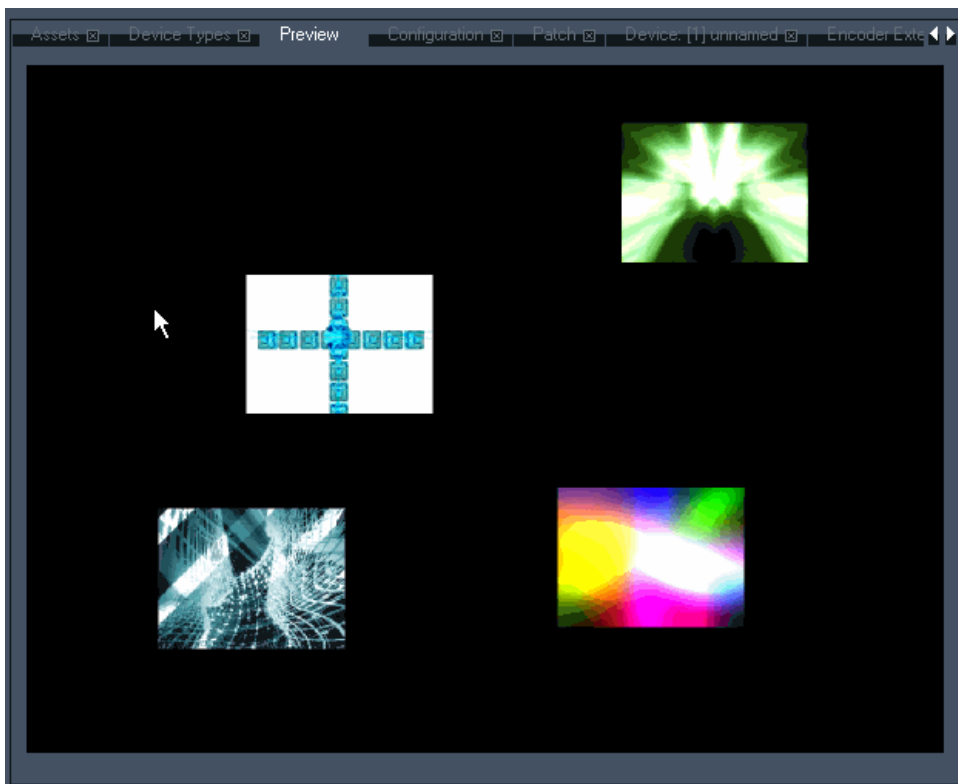

See here information about the [Item Properties of the MultiTouch Panel](#)<sup>937</sup>.



### 17.3.13.2.1 MULTITOUCH ITEM PROPERTIES

To set up the properties of the MultiTouch Panel simply right-click in the GUI and choose the menu entry "Item Properties", press [ALT+P] whilst the mouse is hovering above it or double-click on it when being in the edit / move mode ([ALT+M]). The MultiTouch Dialog opens up. Don't worry if this takes a bit longer than opening the Item Properties of other controls.

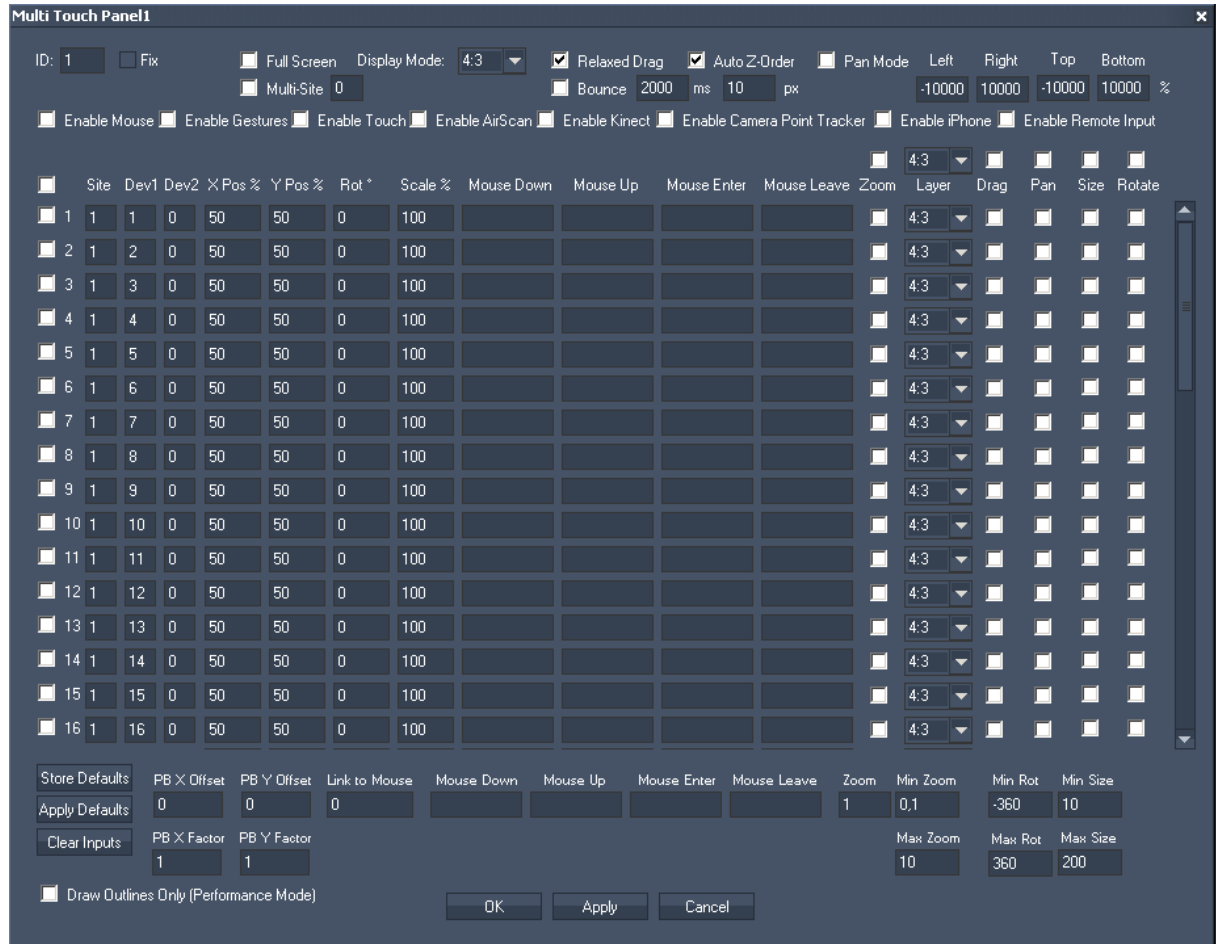

The Item Properties dialog is divided into three different sections: [Panel Settings](#),<sup>937</sup> [Device Settings](#)<sup>941</sup> and [PB Settings](#).<sup>945</sup>

#### 17.3.13.2.1.1 PANEL SETTINGS

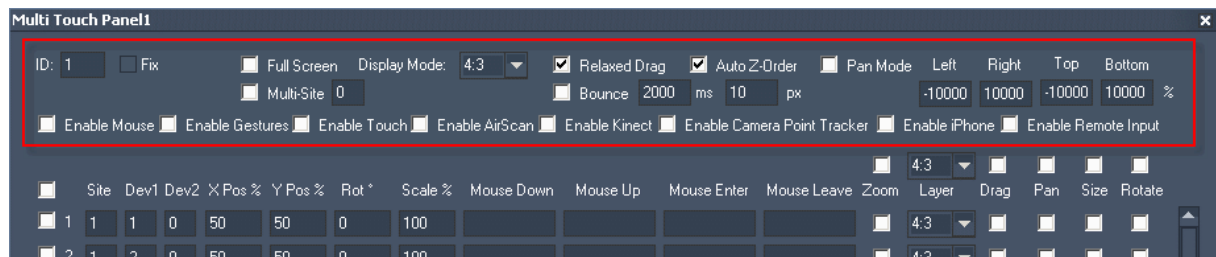

**ID:**

The MultiTouch Panel's ID may be changed by entering a new one in the text field top left.

**Fix:**

When the option "Fix" is checked, the MultiTouch Panel will be displayed on every page inside WD.

**Fullscreen:**

Check this option so that the MultiTouchPanel covers the full screen of your WD computer.

**Display Mode:**

Please choose between the Display Modes 4:3, 16:9 and 16:10, according to the aspect ratio of your WD computer screen. This is needed to have the devices in the correct aspect ratio inside the MultiTouch Panel.

**Multi Site:**

The Multi Site Mode allows controlling multiple Servers simultaneously. This is useful when virtual sites can not be used. Check this option and enter the amount of Sites the position and scale data of the MultiTouch Items should be routed to.

**Example:**

MultiTouch Item 1 refers to Site1, Layer1. When Multi Site Mode with 2 Sites is enabled, the data of this Item will now refer to Site1, Layer1 and Site2, Layer 1 as well.

**Relaxed Drag:**

When Relaxed Drag is enabled, an item will not stop hard at a position to which it was dragged, but it will run out smoothly depending on the dragging speed. This option is active by default.

**Example:**

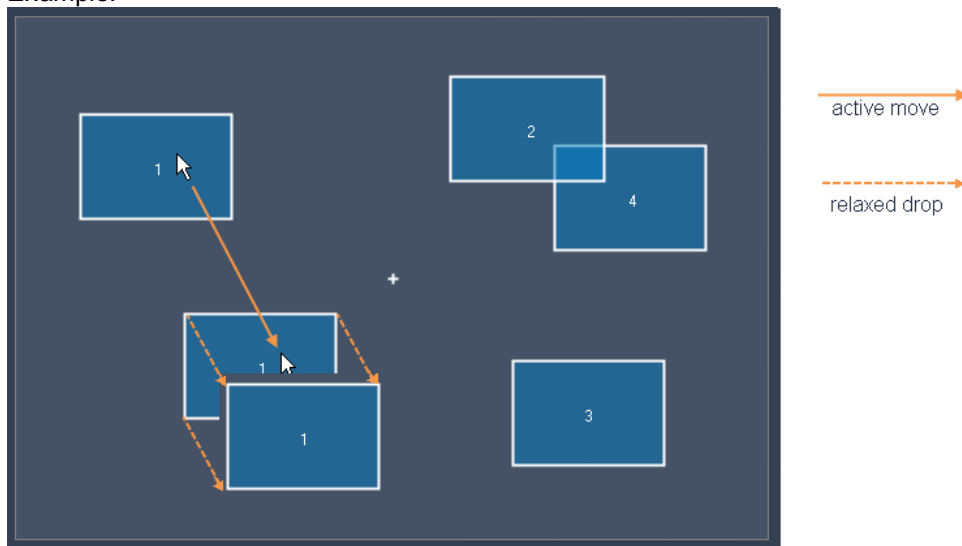

The Relax time (in ms) and the maximum Relax Delta (in px) may be adjusted in the text fields below “Relaxed Drag”. The higher the Relax time, the longer the Item will be dragged. The Relax Delta defines the max. distance in px the Item will be dragged.

**Bounce:**

When the Bounce Mode is enabled, an Item running out smoothly with relaxed drag will bounce back from the display border and reverse its direction towards the display region.

**Auto Z-Order:**

When this option is checked, the selected item inside the MultiTouch Panel will automatically be placed in front of other items inside Pandoras Box (if one item overlays another one). This option influences the Z Position of the layer in PB the devices are linked to. Do not use Auto Z-Order, if you have assigned non-default Z Positions to the layers manually.

Please note: this option is not working when controlling PB Players, as there is no Z Position available for Player devices.

Example:

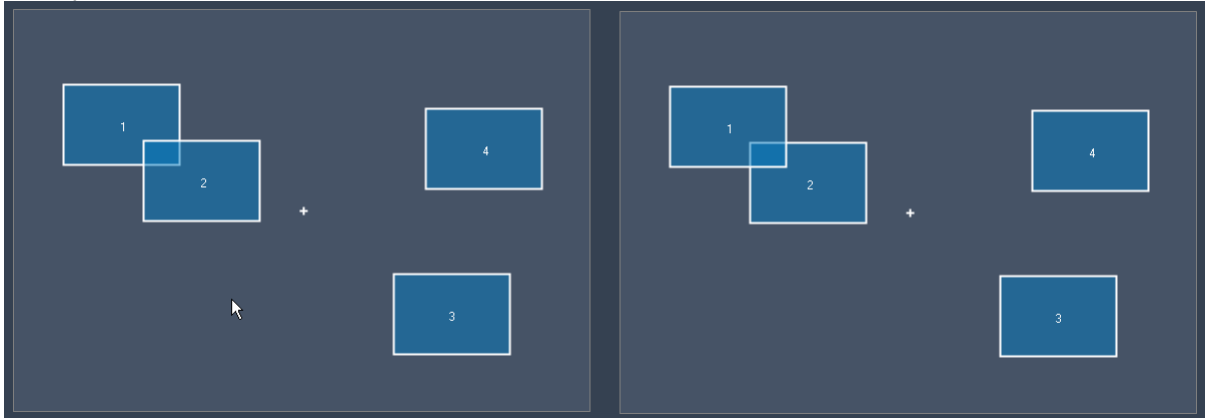

Left: Item2 is in front of Item1. Right: After selecting Item1 the Z Order changes and Item2 is behind Item1.

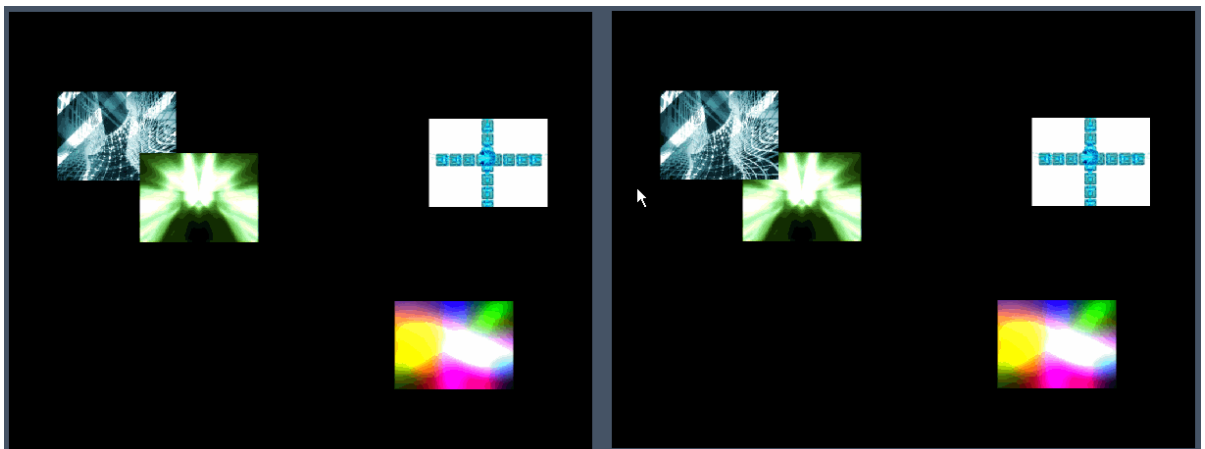

Left and right: see this effect in PB.

**Pan Mode:**

The Pan Mode needs to be checked if you want to move items on the MultiTouch area or out of it by clicking in the background and proceed a move there. This will then apply to all items that have the Pan option enabled.

**Please note:**

Pan is only working when option [Enable Mouse] is checked inside the MultiTouch Panel and when your device (Mouse, Kinect, AirScan, Multitouchdevice etc.) controls the mouse of your WD computer.

Example:

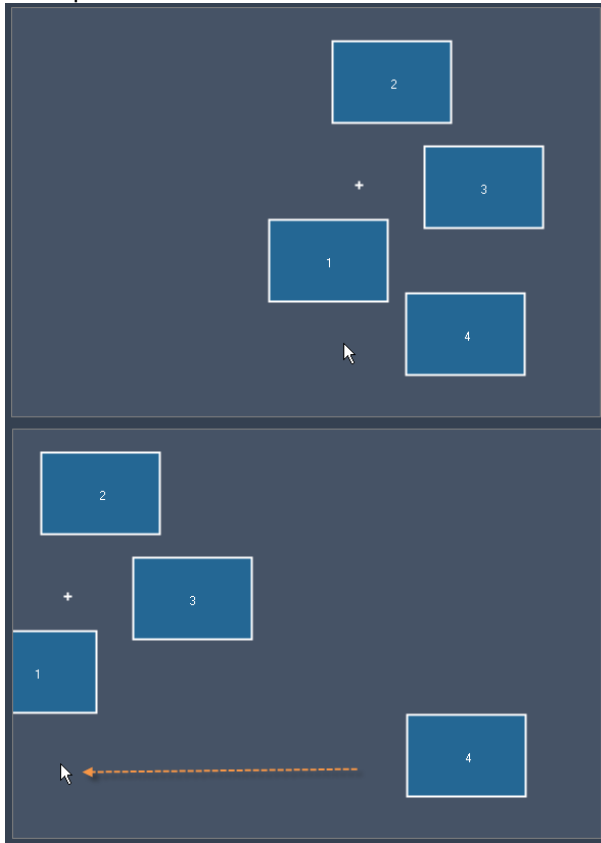

Pan-Mode is enabled for the MultiTouch Panel and for the Items 1, 2 and 3, but not for Item4.

The two pictures above show the result after clicking in the panel's background and moving the mouse over to the left side:

Item4 stays at its previous position while the Items 1,2 and 3 are moved to the left side as well. The little + in the panel's background shows you the PAN position.

Left / Right / Top / Bottom:

The values inside the text fields define how many percent the MultiTouch area can be moved in each direction when PAN is enabled.

Example:

If you change the value for Top and Bottom to 0 (%) you won't be able to move the MultiTouch area up and down, but only to the left and right side.

Input Sources:

Important notice regarding Multi-Touch Input on Win7:

The Tablet Service must be active in order for Win7 to provide the multi touch data!

Enable Mouse:

Enable the mouse input if you want to use the mouse to control the MultiTouch items.

Please note:

The Mouse Input needs to be enabled when you want to use the Pan Mode!

**Enable Gestures:**

Enable this option if you want to use Synaptics Touch Pads and Wacom Bamboo Devices.

**Enable Touch:**

Enable this option if you want to use touch devices like (Multi-)Touch Monitors.

**Enable AirScan:**

Enable this option if you want to use the [AirScan](#)<sup>1155</sup>.

**Enable Kinect:**

Enable this option if you want to use the [Kinect](#)<sup>1162</sup>.

**Enable Camera Point Tracker:**

Enable this option if you want to use the [Camera Point Tracker](#)<sup>1224</sup>.

**Enable iPhone:**

Enable this option if you want to use your iPhone with the Widget Designer Remote App to control the MultiTouch items.

**17.3.13.2.1.2 DEVICE SETTINGS**

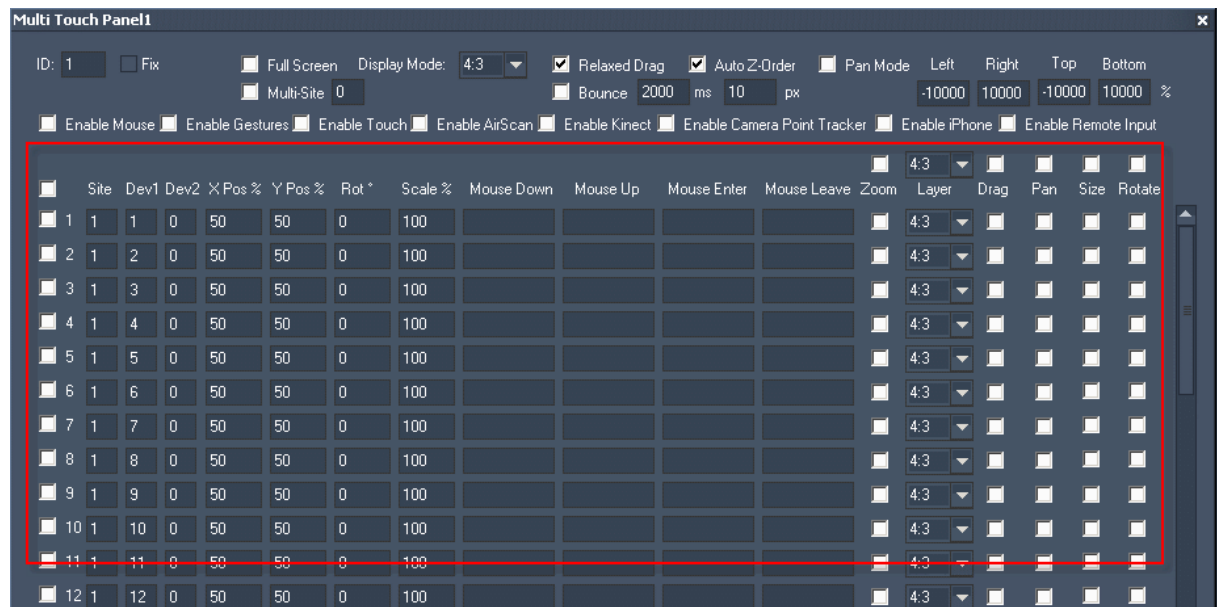

**Check box in front of each line:**

To enable items in the MultiTouch Panel, that will control a layer in Pandoras Box, you have to check the small box in front of a line. To enable all possible 48 items at once, check the small box that is located above all others.

**Device (Site/Dev1/Dev2):**

To link a MultiTouch Item to a layer in Pandoras Box, enter the Site ID (Site) and the Layer ID (Dev1).

Example: If MultiTouch item 1 should control Layer 2 of site 1 (number in front of the Layer is 1.2), please enter 1 in the first text field and 2 in the second one.

You may link a second layer to the same MultiTouch Item – for example a shadow that is on a separate layer – enter the Layer ID into the Dev2 text field.

Example: If MultiTouch item 1 should control Layer 4 and 5 of site 1, please enter 1 | 4 | 5.

XPos and Y Pos:  
 The X and Y position values are percentage values.

**Example:**

Having an item (1) inside the MultiTouch Panel with the value 50 for X and Y Position means that its center point is located at 50% of the whole Panel's X and Y range. The center point of an item (2) with the values X=0 and Y=25 is, according to this, located leftmost and in the upper quarter of the panel, see image below at the left side.

As the whole MultiTouch Panel (no matter up to which size you scale it) always represents the visible PB output area (if no Cam Z Position is changed) these values will be transferred 1:1 to the PB fullscreen output, see image below at the right side.

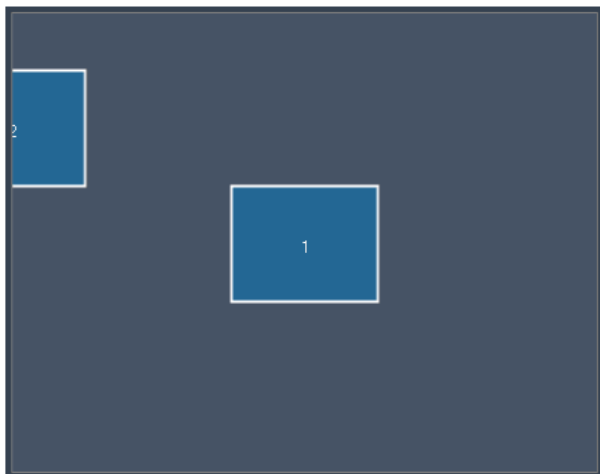

a) MultiTouch Panel:  
 Item 1 is located in 50,50 (X,Y), Item 2 in 0,25 (X,Y).

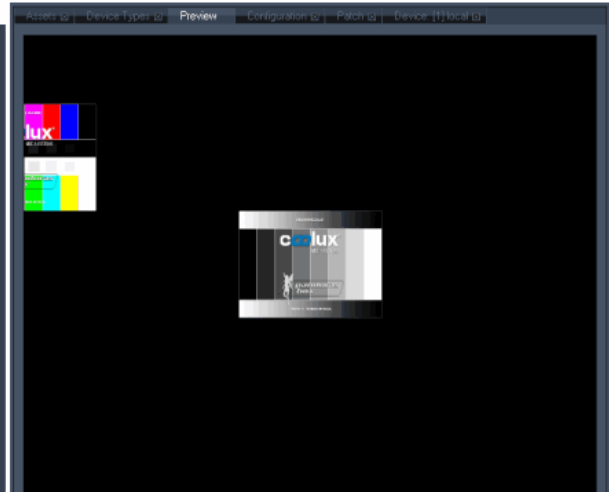

b) Pandoras Box Output:  
 The two layers match perfectly to the items' position and scaling just as in the MultiTouch Panel.

**Rotate:**

The rotation value of an item (in °) can be entered manually in this text field.

The interactive rotation of an item will be achieved when using a multi-point / -touch device.

Enter the Item with two touch points and change the angle between them, see picture below.

Please note: the option [Rotate] has to be enabled for this Item!

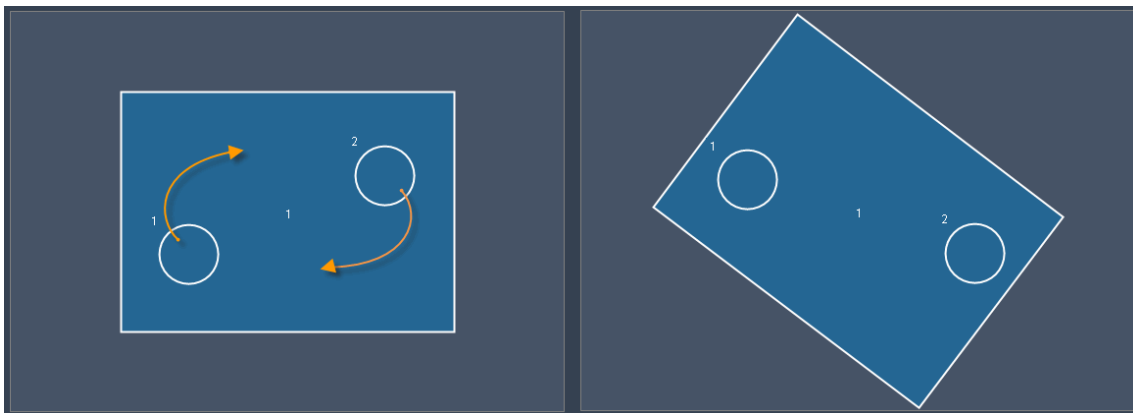

**Scale:**

The scale of an item (in %) refers, same as the position values, to the whole MultiTouch Panel area and therefore to the PB Output area. The item in the example below (left side) has the scaling value 30, so it covers 30% of the width and the height. An item with the scaling value 100 covers the whole screen.

The interactive scaling of an item will be achieved when using a multi-point / -touch device.

Enter the Item with two touch points and change the distance between them, see picture below.

Please note: the option [Size] has to be enabled for this Item!

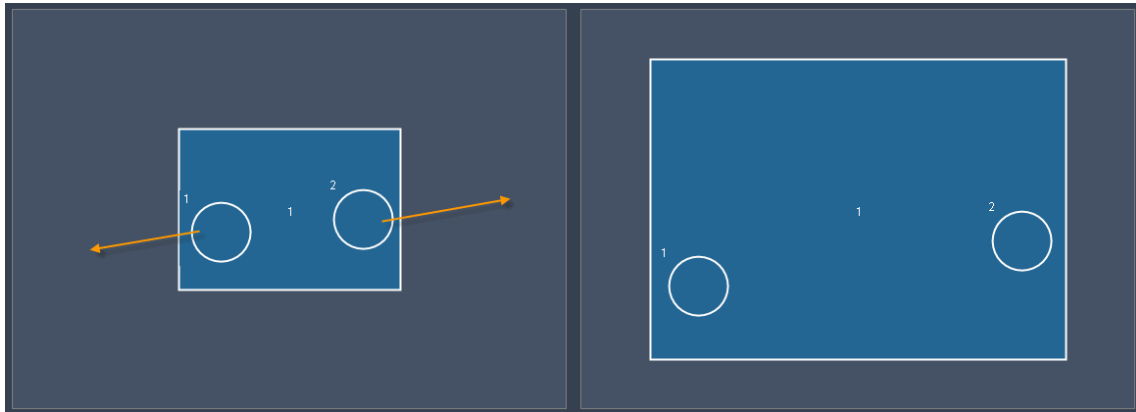
**Mouse Down / Up / Enter / Leave:**

The MultiTouch Panel offers script processing for different mouse interactions.

“Mouse Down” is processed when a mouse left button down click on the item is done.

“Mouse Up” is processed when a mouse left button up click on the item is done.

“Mouse Enter” is processed when the mouse cursor enters the item.

“On Mouse Leave” is processed when the mouse cursor leaves the item.

Any command that is available from the [command list](#)<sup>1260</sup> may be used, just enter it in the text field. Multiple commands (i.e. one script) can be executed by delimiting every command with a carriage return at the end of the command. As these small text fields do not offer a good overview when using multiple commands, working with [macros](#)<sup>1191</sup> is a good option. The topic [Script Language](#)<sup>1254</sup> explains commands and how to use them in more detail.

**Zoom:**

The Zoom option applies to the whole MultiTouch Panel and to all Items that have the Zoom option enabled.

The interactive zooming will be achieved when using a multi-point / -touch device.

Enter the MultiTouch Panel with two touch points and change the distance between them.

Please note: this only works for Items that have the option [Zoom] enabled. All other items will keep their original size.

Example:

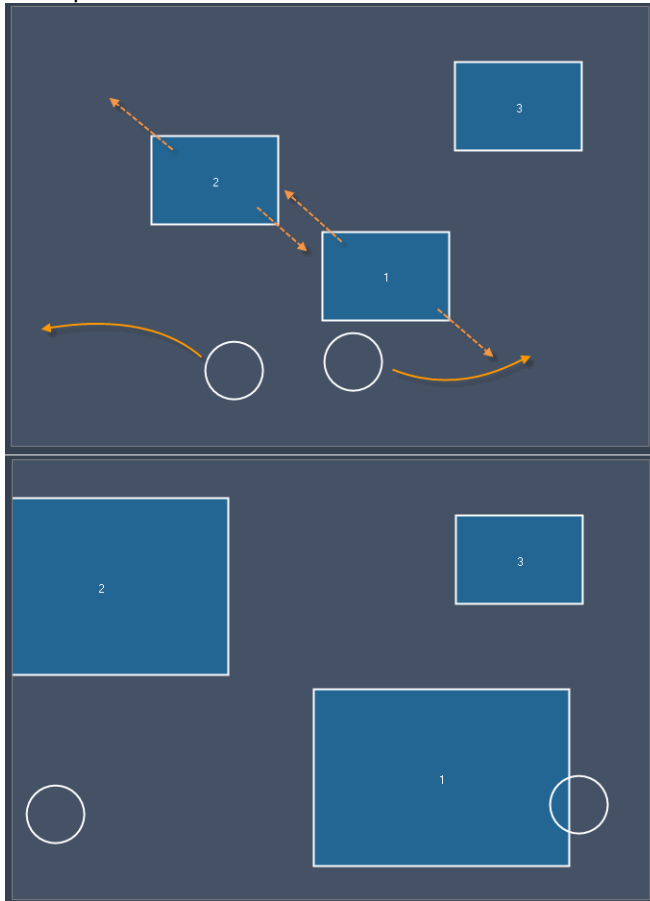

Item 1 and 2 have the Zoom option enabled, Item 3 doesn't.

So after zooming the MultiTouch Area with two touch points, the zoom is applied to Item 1 and Item 2. Item 2 keeps its former size.

The Zoom factor may be changed via commands as well:

[WDMultiTouchSetZoom,'ID','Zoomfactor'](#)<sup>1352</sup>

Layer:

Please choose the Aspect Ratio for the item (4:3, 16:9 or 16:10), according to the aspect ratio of the file assigned to the layer. This is needed to display the media file with its correct aspect ratio in Pandoras Box.

If all media files on the layers in Pandoras Box have the same aspect ratio just check the small box on top to apply this aspect ratio to all items.

Drag:

To move an item on the MultiTouch Panel you need to have the mouse clicked on this Item or place a touch point on it. Moving the mouse / touch point will drag the Item. See example below.

Please note: The option Drag needs to be enabled for the Item.



Example: Dragging an Item.



Pan:

Enable Pan if you want to move an item on the MultiTouch area or out of it by clicking in the background and proceeding a move there (instead of moving the item itself directly). This allows moving several items that have the Pan option enabled at once.

The Pan Mode in the Panel Settings as well as [Enable Mouse] needs to be checked!

--> See an example for Pan in the section "A. Panel Settings"!

Size:

Enable Size if you want to scale an item with a support device that provides two (mouse-) points (e.g. the AirScan) instead of a single touch (e.g. the mouse). By changing the distance between the two points you will increase or decrease the item's scaling when the item is selected.

--> See an example for Size in the section "B. Device Settings" under the cue "Scale"!

Rotate:

Enable Rotate if you want to rotate an item with a support device that provides two (mouse-) points (e.g. the AirScan) instead of a single touch (e.g. the mouse). By changing the angle between the two points you will rotate the item clockwise or anti-clockwise when the item is selected.

--> See an example for Rotate in the section "B. Device Settings"!

### 17.3.13.2.1.3 PB SETTINGS

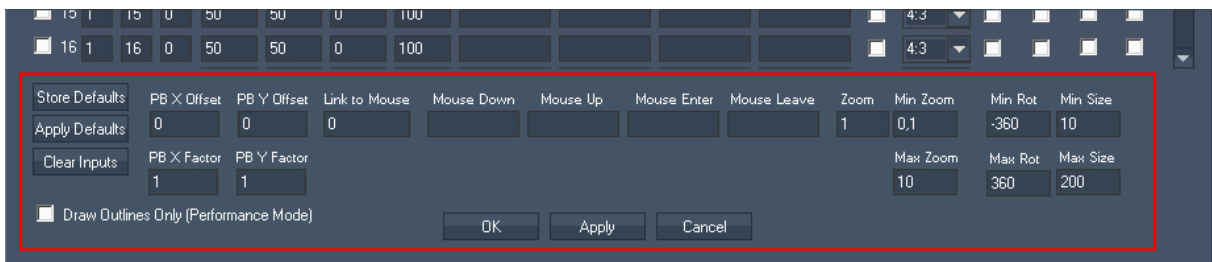

[Store Defaults]:

Once the MultiTouch Panel is set up, you may want to store the current values as Default Values within this WD Project. To do so, press [Store Defaults] or use the command [WDMultiTouchStoreDefaults.'](#)*ID'*<sup>1352</sup>.

[Apply Defaults]:

To recall the default values for the MultiTouch Panel (see [Store Defaults] above) press [Apply Defaults] or use the command [WDMultiTouchApplyDefaults.'](#)*ID'*<sup>1352</sup>.

[Clear Inputs]:

In case that the network connection to the AirScan or another Remote input was lost while these devices sent active touch points, the MultiTouch Panel can be cleared from these hanging touch points by pressing [Clear Inputs].

PB X Offset / PB Y Offset:

If you need an offset for the X or Y position of all items in Pandoras Box please enter it here. The values correspond to the position values used in Pandoras Box.

Example:

Item 1 is on position 50 (this corresponds to the XPos value 32768 in PB, when being in non-centered mode). Entering a PB X Offset of 200 changes this XPos value from 32768 to 32968 in PB – the item in the MultiTouch Panel stays at the same position.

PB X Factor / PB Y Factor:

To use the MultiTouch Panel with several Pandoras Box Outputs (e.g. with an softedge projection with 3 outputs in a line) the X and/or Y Factors have to be adjusted to assign the MultiTouch panel area to the new screen dimension.

By default the PB X/Y Factor is set to 1, so the MultiTouch Panel refers to only one PB fullscreen output.

See here an example how to assign the MultiTouch Panel area to a new screen dimension:

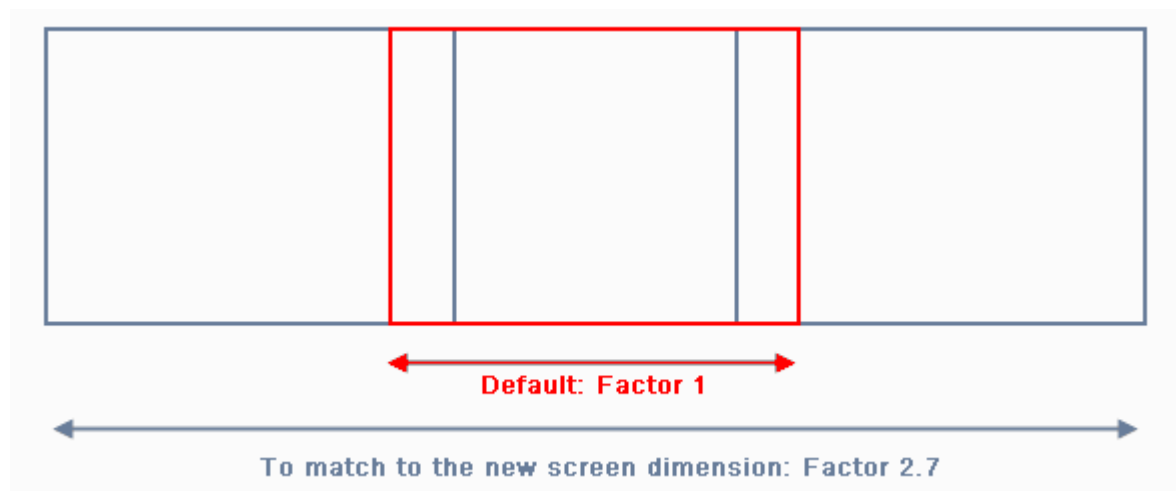

Having a softedge projection with 3 Pandoras Box outputs in a line, the PB X Factor has to be changed to the new screen width (in the image above the new factor has to be 2.7). Otherwise you won't be able to position a MultiTouch Item on the left or right screen.

Link To Mouse:

The value 0 means that no MultiTouch item is linked to the mouse. If you change this value to e.g. 1, Item 1 will be linked to the mouse until this entry is changed (manually or via commands). As long as the item is linked to the mouse, it will follow the mouse over the MultiTouch Area although Drag is disabled.

Relevant for this feature the following commands may be executed, from within the MultiTouch Panel or from other controls like e.g. Custom Script Buttons:

[WDMultiTouchLinkToMouse.'ID'. 'ItemID'](#)<sup>1356</sup>

[WDMultiTouchLinkItemToMouse.'ID'](#)<sup>1357</sup>

[WDMultiMouseLinkPlay.'ID'](#)<sup>1357</sup>

[WDMultiMouseLinkLoop.'ID'](#)<sup>1357</sup>

[WDMultiMouseLinkPause.'ID'](#)<sup>1357</sup>

[WDMultiMouseLinkStop.'ID'](#)<sup>1358</sup>

Mouse Down / Up / Enter / Leave:

The MultiTouch Panel offers script processing for different mouse interactions, valid for the whole MultiTouch area:

“Mouse Down” is processed when a mouse left button down click on the panel is done.

“Mouse Up” is processed when a mouse left button up click on the panel is done.

“Mouse Enter” is processed when the mouse cursor enters the panel.

“On Mouse Leave” is processed when the mouse cursor leaves the panel.

Any command that is available from the [command list](#)<sup>1260</sup> may be used, just enter it in the text field. Multiple commands (i.e. one script) can be executed by delimiting every command with a carriage return at the end of the command. As these small text fields do not offer a good overview when using multiple commands, working with [macros](#)<sup>1191</sup> is a good option. The topic [Script Language](#)<sup>1254</sup> explains commands and how to use them in more detail.

Zoom:

Here you may change the Zoom factor that will be applied to all items having the Zoom option enabled. The factor can be changed via the command ([WDMultiTouchSetZoom.'ID'. 'Zoomfactor'](#)<sup>1352</sup>) as well.

Min / Max Zoom:

These adjustable values will allow you to limit the minimum and maximum zoom factor (in %).

--> See an example for using the Zoom in the section “B. Device Settings”!

Min / Max Rot:

The values (in degree) for minimum and maximum rotation allow you to set the amount of degrees the items are allowed to be turned. This function is limited to maximum +/- 360 degree.

--> See an example for Rotate in the section “B. Device Settings”!

Min / Max Size:

Enter new values here (in %) in order to change the minimum and maximum size an item is allowed to have.

--> See an example for Size in the section “B. Device Settings” under the cue “Scale”!

See [here](#)<sup>1352</sup> the list of all commands that influence the MultiTouch Panel:

### 17.3.13.3 XY PANEL

The XY Panel represents a graphical touch pad with relative or absolute value controls.

To create an XY Panel right-click anywhere on the empty main background window and go to "Create"->"Panel"->"XY Panel"

Once you have clicked on the last menu item the mouse cursor will change to a crosshair icon.

This icon tells you that you are in the create mode.



To create one or multiple XY Panels just left click anywhere on the empty main background window and you will see a new panel being assigned and displayed.

The XY Panel can now be used by clicking inside of the panel region and dragging the mouse around.

Next you will need to set up the properties of the newly built XY Panel control. To edit the XY Panel parameters simply right-click on it and choose the menu entry "Item Properties", press [ALT+P] whilst the mouse is hovering above it or double-click on it when being in the edit / move mode ([ALT+M]). The XY Panel Property Dialog opens up.

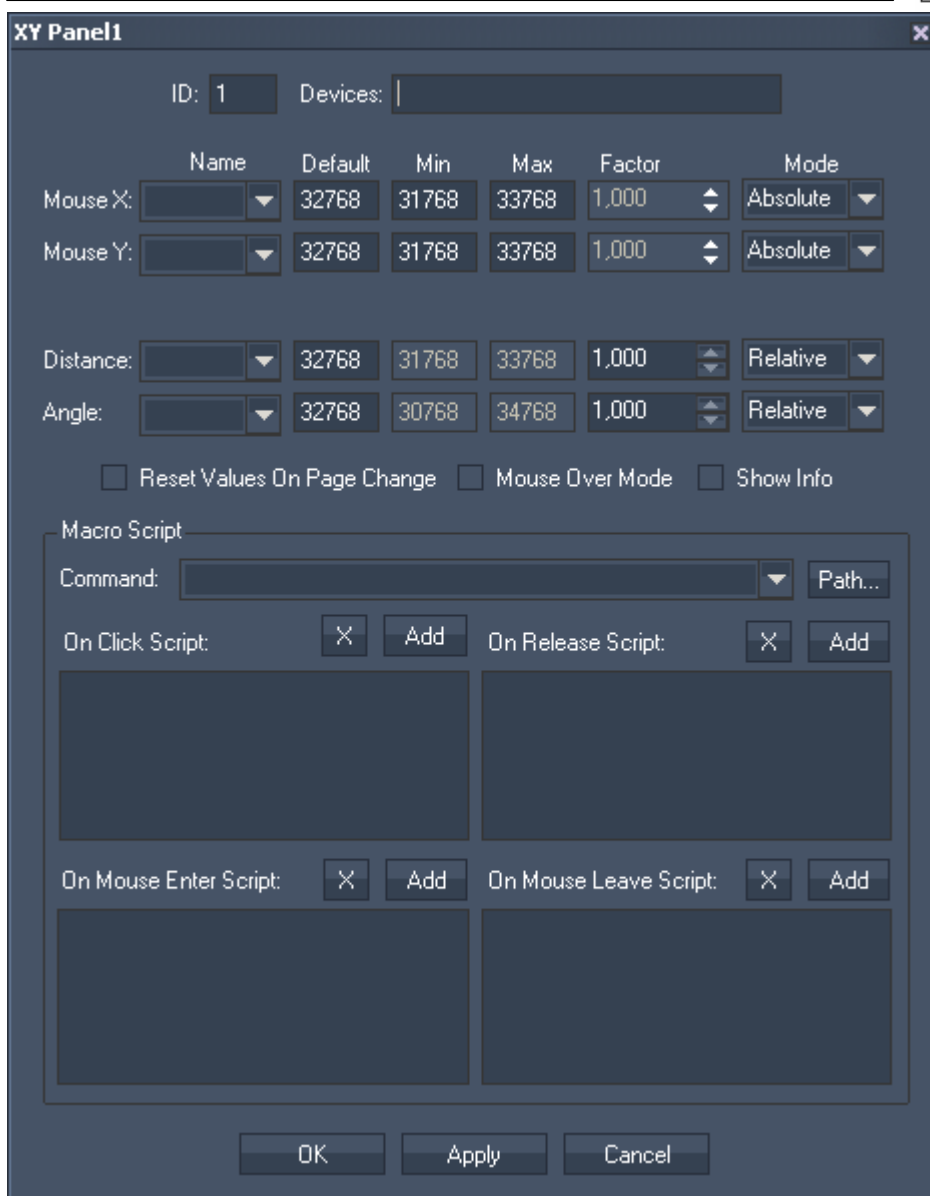

The XY Panel's ID may be changed by entering a new one in the text field top left.

To assign the XY Panel to one or multiple Pandoras Box devices enter the site and device ID in the device text field.

For example to control Server 1 Layer 1 and Server 2 Layer 2 enter "1.1 2.2"

You may assign different parameters to the X and Y axis by choosing the parameters from the drop-down list.

Default values are sent on page enter when the option "Reset Values On Page Change" is checked.

Depending on the mode you can either set a minimum or maximum value for absolute parameter control.

If you choose to use the relative mode then you might apply a factor to affect the strength of the value increment based on the mouse input motion.

The parameter's distance and angle are reserved for the AirScan & iPhone multi-touch input.

---

Check "Mouse over Mode" if you want the panel to react on any mouse motion independent of the left mouse button press.

This is in particular useful and depending on the settings of the attached touch screen driver.

"Show info" allows you to display the current values of the panel.

## Script

The XY Panel offers [script](#)<sup>1254</sup> processing for different mouse interactions.

"On Click" is processed when a mouse left button down click on the panel control is being performed by the user.

"On Release" is processed when a mouse left button up click on the panel control is being performed by the user.

"On Mouse Enter" is processed when the mouse cursor enters the panel control.

"On Mouse Leave" is processed when the mouse cursor leaves the panel control.

To enter commands you may use the drop-down list and the "Add" button or type directly in the text field. The topic [Script Language](#)<sup>1254</sup> explains this in more detail.

See here a list of all [commands](#)<sup>1260</sup>.

**17.3.14 TEXT INPUT**

The Text Input control lets you add an editable text to remote control text assets within Pandoras Box.

Depending on the configuration of the Text Input control you may update dedicated text assets by clicking on the Last Line and Next Line button. This way you may continuously update text assets line by line or update the entire textbox contents to the text asset on all connected Pandoras Box Client systems.



To edit the Text Input parameters first switch to the edit / move mode ([ALT+M]) and then right-click on the desired Text Input control and choose the menu entry "Item Properties", press [ALT+P] whilst the mouse is hovering above it or double-click on it when being in the edit / move mode ([ALT+M]). The Text Input Property Dialog opens up.

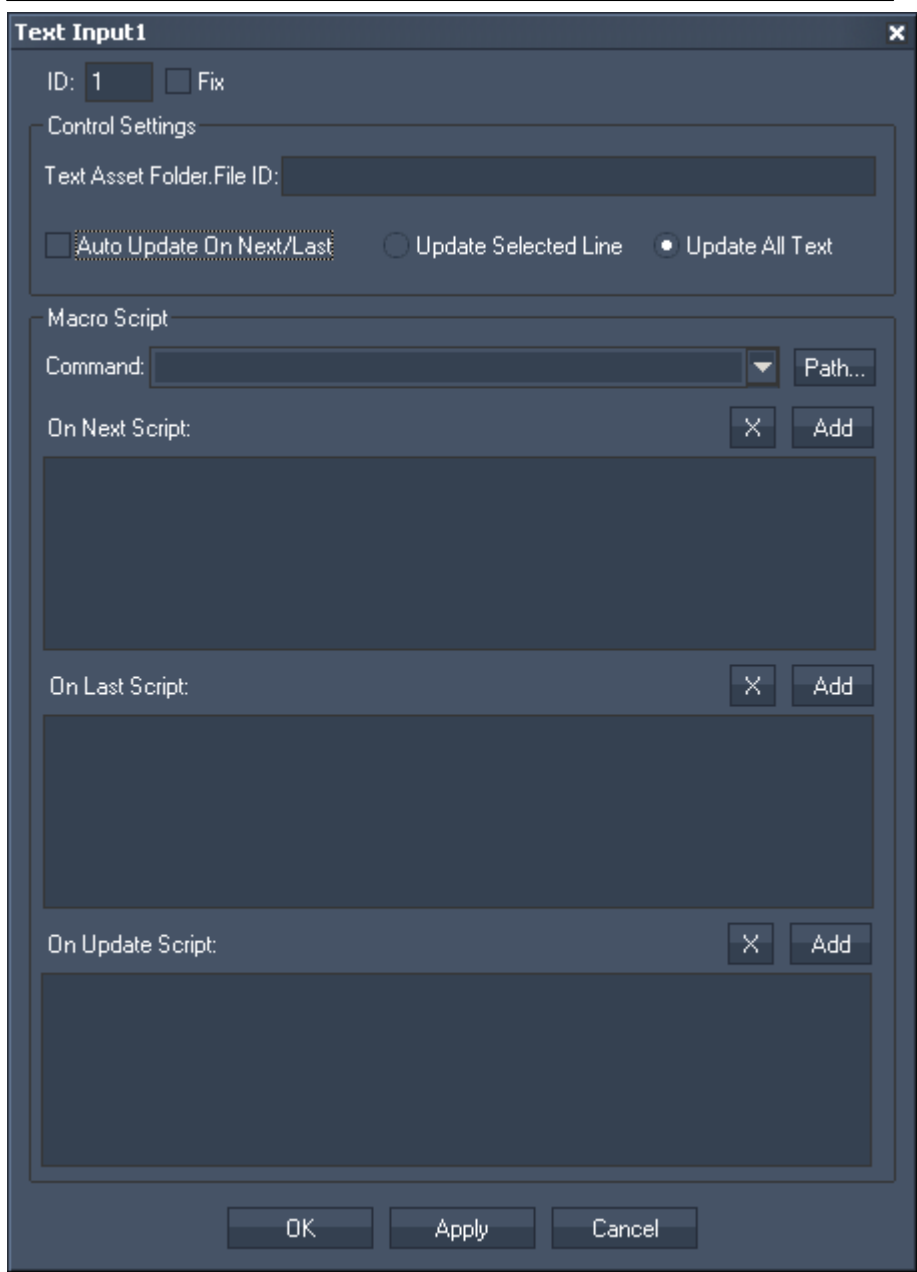

**ID:**  
The Text Input's ID may be changed by entering a new one in the text field top left.

**Fix:**  
When the option "Fix" is checked, the Text Input will be available on every page.

**Control Settings:**  
Define one or multiple Text Assets in PB this Text Input should be linked to. To do this please enter the Folder and File ID's.

**Example:**  
To assign the Text Input to Server 1 Layer 1 and Server 1 Layer 2, enter: "1,1 1,2".

**Auto Update On Next/Last:**  
This option will send the text contents directly upon button press.



Update Selected Line / Update All Text:

Choose between these two options to update only by line or complete text.

Furthermore you may want to link specific commands to the Next/Last Line and Update button press. You may use the drop-down list and the "Add" button or type directly in the text field. The topic [Script Language](#)<sup>1254</sup> explains this in more detail.

See here a list of all [commands](#)<sup>1260</sup>. To control the Text Input from e.g. a Custom Script Button, [these commands](#)<sup>1382</sup> may be used.

### 17.3.15 TEXTBOX

The Textbox control allows you to add an editable text to remote control text assets within Pandoras Box via the [Textbox Input Node](#)<sup>1056</sup> and the [PB Text Output Node](#)<sup>1125</sup>.

You may as well use this control as a Post-It on the WD User Interface.

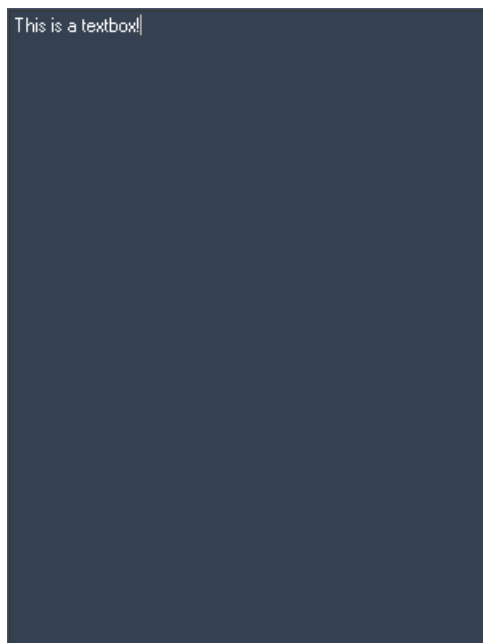

To edit the Textbox's font and colour, first switch to the edit / move mode ([ALT+M]) and then right-click on the desired Textbox control and choose the menu entry "Item Properties", press [ALT+P] whilst the mouse is hovering above it or double-click on it when being in the edit / move mode ([ALT+M]). The Textbox Property Dialog opens up.

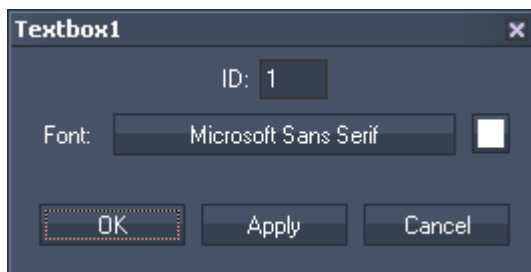

The Text Box's ID may be changed by entering a new one in the text field on the top.

Click on the Font button and in the upcoming pop-up window you may choose the font.

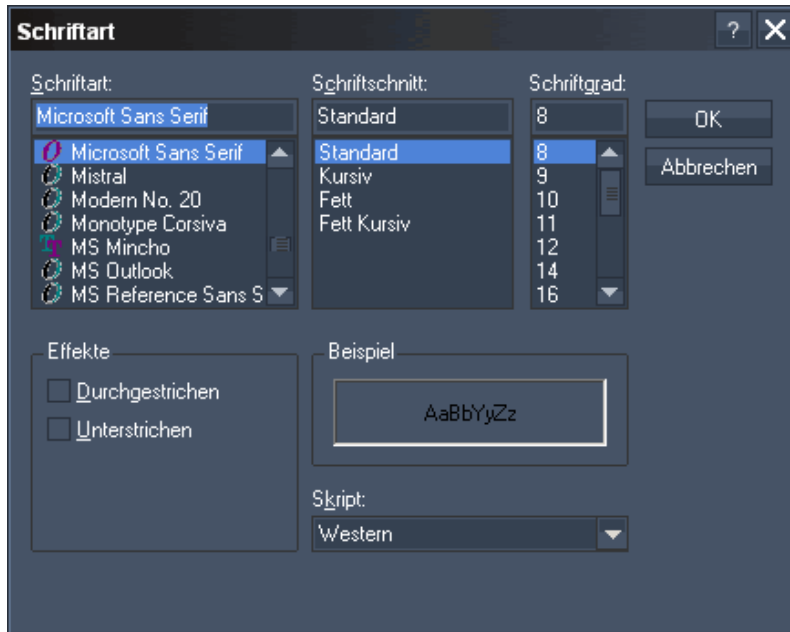

Click in the little box next to the font button and choose a colour from the upcoming pop-up window.



To link the Textbox to a Text asset in Pandoras Box, please use a Text Box Input Node and connect it to a PB Text output node.

To change the text of a Textbox e.g. via a Custom Script Button, [these commands](#)<sup>1376</sup> are available:

### Dynamic script setup

With the following commands you can use a textbox to hold and collect script snippets that could be executed at any given time:

[WDTextboxAppend,'ID','Value'](#)<sup>1378</sup>

[WDTextboxNewline,'ID'](#)<sup>1379</sup>

[WDTextboxExecuteAsScript,'ID'](#)<sup>1379</sup>

Imagine you want to build a signal router remote application. You can use buttons to set the source selection and buttons to append the script code for the target selections. A take button would use the entire script that is inside the textbox and executes it as one big dynamically created script. This way it is much easier to create and react to certain conditions and logics that would require much more nodes to set up.

### 17.3.16 TIMECODE

The Timecode control displays the timecode sent or received via a connected SMPTE Link device. Set up the SMPTE Link device in the [Connection Manager](#)<sup>1166</sup>.

You may also route the sent / received SMPTE Timecode via the [SMPTE Input Node](#)<sup>1055</sup> within the WD Node System.



To design the timecode colors simply right-click on the Timecode control and choose the menu entry "Item Properties", press [ALT+P] whilst the mouse is hovering above it or double-click on it when being in the edit / move mode ([ALT+M]). The Timecode property dialog opens up.

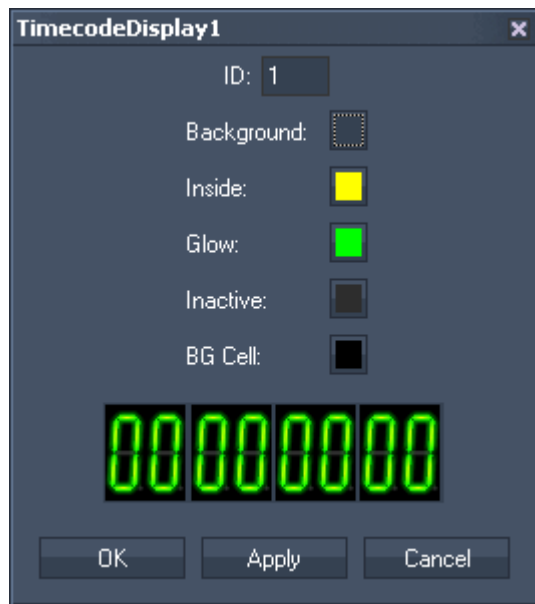

The Timecode's ID may be changed by entering a new one in the text field on the top.

It allows you to choose the colour for the timecodes

- background,
- inside,
- glow,
- inactive,
- background cell.

### 17.3.17 VIDEO PLAYER

The Video Player control lets you add a borderless Windows Media Player control to your interface.

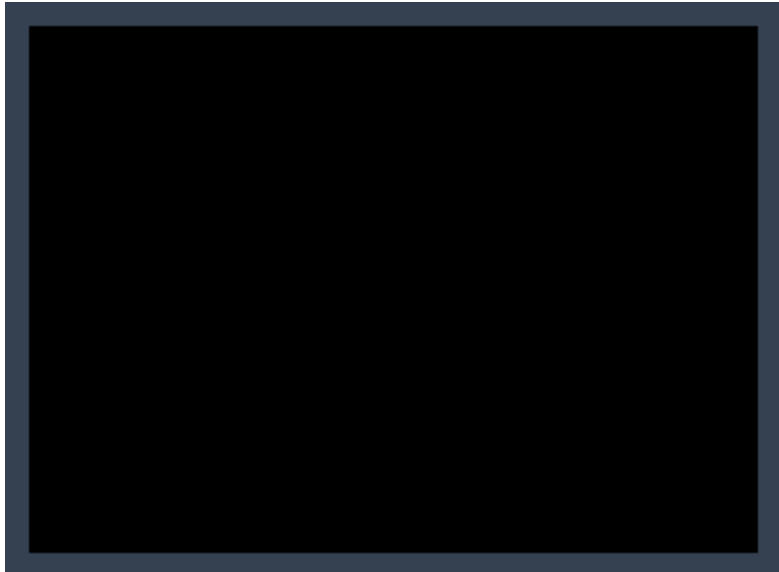

To edit the Video Player parameters first switch to the edit / move mode ([ALT+M]) mode and then right-click on the desired Video Player control and choose the menu entry "Item Properties", press [ALT+P] whilst the mouse is hovering above it or double-click on it when being in the edit / move mode ([ALT+M]). The Video Player Property Dialog opens up.

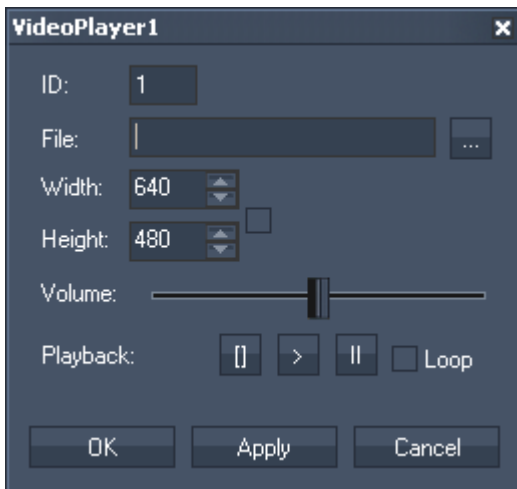

The Video Player's ID may be changed by entering a new one on the top.

In the property dialog you can choose the file and set the size, volume and transport controls of the file.

Please note:

In order to control the Video Player control within your interface it is a best practice to create dedicated [Custom Script Buttons](#)<sup>884</sup> or use [commands](#)<sup>1254</sup> in general to control the Video Player Control. The Video Player related commands are [these ones](#)<sup>1383</sup>.

Please note that only those files can be played that are supported by your system. If additional codecs are required you might need to download or install them from the codec vendor or distributor.

### 17.3.18 VNC PANEL

The VNC Panel control lets you host multiple VNC sessions within one page of the interface.

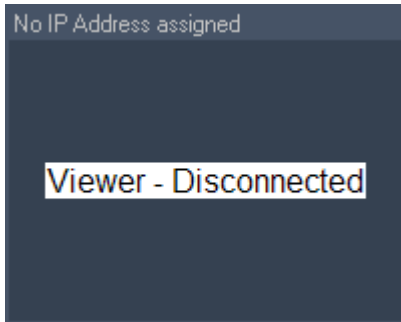

To edit the VNC Panel parameters right-click on the title of the desired VNC Panel control and choose the menu entry "Item Properties", press [ALT+P] whilst the mouse is hovering above it or double-click on it when being in the edit / move mode ([ALT+M]). The VNC Panel Property Dialog opens up.

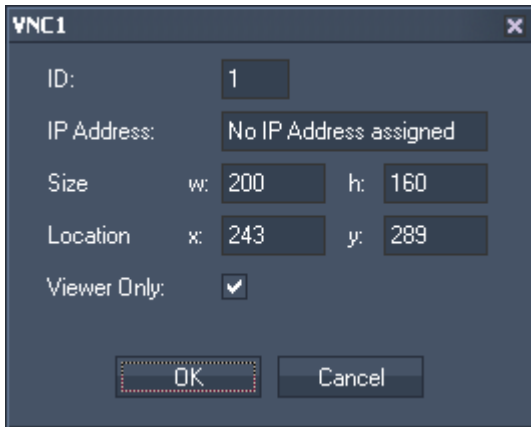

The VNC Panel's ID may be changed by entering a new one in the text field on the top.

In the property dialog of the VNC Panel you may enter the desired IP address to connect to as well as the width, height and location of the control.

If you only want to use the VNC Panels for service purposes you may set the Viewer Only mode where the mouse will not interface with the VNC Panel Control.

After setting the Properties, the VNC Viewer will display the connected device.



### 17.3.19 WEBBROWSER

The Webbrowser control lets you add a borderless Webbrowser control to your interface.

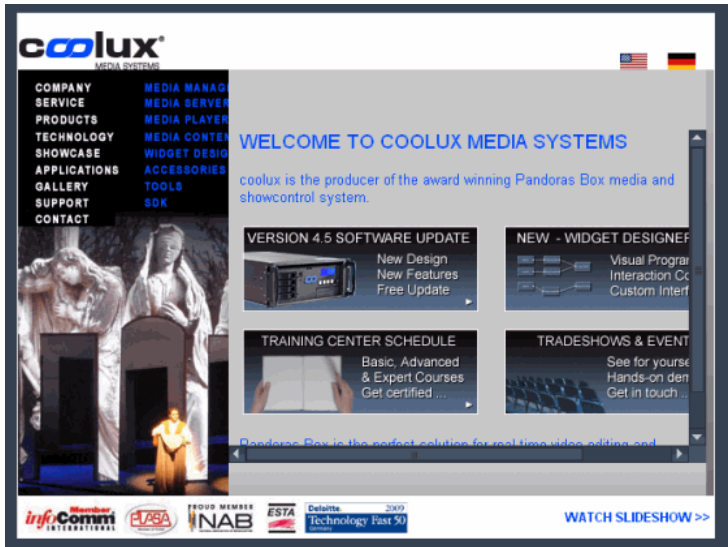

To edit the Webbrowser parameters first switch to the edit / move mode ([ALT+M]) and then right-click on the desired Webbrowser control and choose the menu entry "Item Properties", press [ALT+P] whilst the mouse is hovering above it or double-click on it when being in the edit / move mode ([ALT+M]). The Webbrowser Property Dialog opens up.

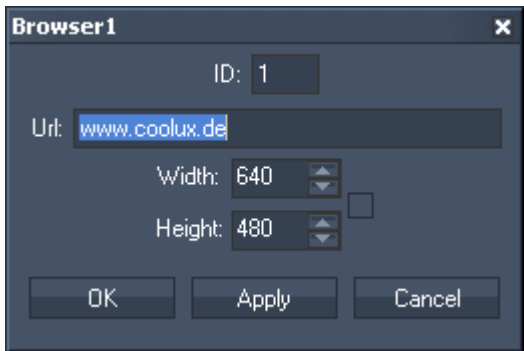

The Browser's ID may be changed by entering a new one in the text field on the top.

In the property dialog you can choose the URL as well as set the size of this control.

If you want to add buttons to navigate to different URLs or to clear the cache info you may use Custom Script Buttons and [these commands](#)<sup>1390</sup> to remote control the Webbrowser.

## 17.4 NODES (WD PRO/ULT ONLY)

The node system in Widget Designer PRO and ULT allows to create custom logic routing of control data. For example you achieve to...

- remote control a Pandoras Box Layer with a standard Joystick
- connect a SensorLink sensor input to any Pandoras Box Layer Parameter
- receive Art-Net values from another device and map these to Midi output values

etc,... The list of possible scenarios is probably endless.

If you have never worked with a node based system, the way it works within Widget Designer is very easy to learn.

There are different types of nodes: [Inputs](#)<sup>980</sup>, [Filters](#)<sup>1070</sup>, [Outputs](#)<sup>1108</sup> and the more advanced [Scripts](#)<sup>1140</sup> and [Interactions](#)<sup>1146</sup>. The table below lists all available nodes.

The next chapter informs you about the different types of nodes and [how to create and work with nodes](#)<sup>964</sup>. If you are interested in a small tutorial click [here](#)<sup>967</sup>.

More advanced users might need to enter incoming or outgoing values as string, decimal or hexadecimal values, please find here the [Syntax TCP- / UDP- / Serial Messages](#)<sup>970</sup>. Some nodes can be controlled via the so called [Node Commands](#)<sup>977</sup>.

<a href="#">Input</a> <sup>980</sup>	Controls	<a href="#">Colour Picker</a> <sup>993</sup>
		Custom Script
		Drop Down List
		<a href="#">Encoder</a> <sup>1001</sup>
		<a href="#">Fader</a> <sup>1003</sup>
		<a href="#">Label</a> <sup>1034</sup>
		<a href="#">Media Control</a> <sup>1034</sup>
		<a href="#">Multi/Touch Item</a> <sup>1039</sup>
		<a href="#">Multi/Touch Panel Point</a> <sup>1040</sup>
		<a href="#">Page</a> <sup>1045</sup>
		<a href="#">Textbox</a> <sup>1056</sup>
		<a href="#">Wheel</a> <sup>1068</sup>
		<a href="#">XY Panel</a> <sup>1070</sup>
	Connections	<a href="#">Art-Net</a> <sup>987</sup>
		<a href="#">COM ASCII Stream</a> <sup>995</sup>
		<a href="#">COM Port</a> <sup>994</sup>
		<a href="#">COM Query String</a> <sup>996</sup>
		COM Status
		<a href="#">DMX Link In</a> <sup>999</sup>
		<a href="#">Midi In</a> <sup>1035</sup>
		<a href="#">Midi Note Catch</a> <sup>1036</sup>
		<a href="#">OSC</a> <sup>1044</sup>
		<a href="#">Remote Touch Item</a> <sup>1049</sup>
		<a href="#">Sensor Link</a> <sup>1051</sup>
		<a href="#">SerialLink GPI</a> <sup>1053</sup>
		SMPTE Link
		<a href="#">TCP</a> <sup>1059</sup>
		<a href="#">TCP ASCII Stream</a> <sup>1060</sup>

	<a href="#">TCP Query String</a> <sup>1061</sup>
	TCP Status
	<a href="#">TrackScan</a> <sup>1063</sup>
	<a href="#">TrackScan Serial Link</a> <sup>1064</sup>
	<a href="#">UDP</a> <sup>1065</sup>
	<a href="#">UDP ASCII Stream</a> <sup>1066</sup>
	UDP Data Parser
	UDP Status
Devices	<a href="#">Airbar</a> <sup>984</sup>
	<a href="#">AirScan</a> <sup>985</sup>
	<a href="#">AirScan Multi-Point</a> <sup>986</sup>
	<a href="#">Black Box (BETA)</a> <sup>989</sup>
	<a href="#">iPhone Remote</a> <sup>1030</sup>
	Jog / Fader Extension
	<a href="#">Joystick</a> <sup>1031</sup>
	<a href="#">Kinect</a> <sup>1032</sup>
	<a href="#">Kinesys K2</a> <sup>1032</sup>
	<a href="#">Mouse</a> <sup>1038</sup>
	Natural Point Marker
	<a href="#">ODSL 30</a> <sup>1043</sup>
	Phidgets InterfaceKit 0/16/16
	Phidgets InterfaceKit 8/8/8
	Phidgets HS Encoder (1047)
	<a href="#">Space Navigator</a> <sup>1055</sup>
	<a href="#">Timax</a> <sup>1058</sup>
	<a href="#">Wii</a> <sup>1069</sup>
File System	Excel Reader
	<a href="#">Text Reader</a> <sup>1057</sup>
	Watch Folder
Generic	<a href="#">Audio</a> <sup>988</sup>
	Audio Processor
	<a href="#">Clock</a> <sup>993</sup>
	<a href="#">Count Down</a> <sup>997</sup>
	<a href="#">Counter</a> <sup>998</sup>
	Generator
	<a href="#">GPS</a> <sup>1004</sup>
	<a href="#">Ping</a> <sup>1046</sup>
	<a href="#">Random</a> <sup>1048</sup>
	<a href="#">Value</a> <sup>1067</sup>
	<a href="#">Variable</a> <sup>1068</sup>
Pandoras Box	Clip Remaining Time
	Cue Remaining Time
	<a href="#">Device Parameter</a> <sup>1045</sup>
	Layer Interaction
	Sequence Timecode
	Widget Device



	<b>Tools</b>	<a href="#">Camera Point Tracker</a> <sup>992</sup>
		<a href="#">Email</a> <sup>1000</sup>
		<a href="#">Events</a> <sup>1001</sup>
		<a href="#">Face Tracking</a> <sup>1003</sup>
		<a href="#">Motion Detector</a> <sup>1037</sup>
		<a href="#">RSS</a> <sup>1050</sup>
		<a href="#">SMS</a> <sup>1054</sup>
<a href="#">Filter</a> <sup>1070</sup>	<a href="#">Add Relative</a> <sup>1073</sup>	
	Angle Distance	
	<a href="#">Angle to Point</a> <sup>1074</sup>	
	Compare	
	<a href="#">Damping Prediction</a> <sup>1075</sup>	
	<a href="#">Damping Timed</a> <sup>1076</sup>	
	Delay	
	<a href="#">Delta</a> <sup>1077</sup>	
	<a href="#">Dynamic Trigger</a> <sup>1078</sup>	
	<a href="#">If</a> <sup>1079</sup>	
	Is In Bounding Box	
	Is In Range	
	<a href="#">Jitter Reduce</a> <sup>1080</sup>	
	<b>Math Nodes</b>	<a href="#">Abs</a> <sup>1086</sup>
		<a href="#">ACos</a> <sup>1086</sup>
		<a href="#">Add</a> <sup>1087</sup>
		<a href="#">ASin</a> <sup>1088</sup>
		<a href="#">ATan</a> <sup>1088</sup>
		<a href="#">Ceiling</a> <sup>1089</sup>
		<a href="#">Cos</a> <sup>1089</sup>
		<a href="#">Degree &gt; Radians</a> <sup>1090</sup>
		<a href="#">Divide</a> <sup>1090</sup>
		<a href="#">Floor</a> <sup>1091</sup>
		<a href="#">Log</a> <sup>1092</sup>
		<a href="#">Modulo</a> <sup>1092</sup>
		<a href="#">Multiply</a> <sup>1093</sup>
		<a href="#">Percent</a> <sup>1094</sup>
		<a href="#">Power X^Y</a> <sup>1094</sup>
		<a href="#">Radians &gt; Degree</a> <sup>1095</sup>
		<a href="#">Round</a> <sup>1096</sup>
		<a href="#">Sin</a> <sup>1096</sup>
		<a href="#">Sqrt</a> <sup>1097</sup>
		<a href="#">Subtract</a> <sup>1098</sup>
		<a href="#">Sum</a> <sup>1098</sup>
		<a href="#">Tan</a> <sup>1099</sup>

	<a href="#">Max</a> <sup>1081</sup>	
	<a href="#">Min</a> <sup>1082</sup>	
	<a href="#">Polar &gt; Rectangular</a> <sup>1083</sup>	
	Prediction	
	<a href="#">Range Asymmetric</a> <sup>1085</sup>	
	<a href="#">Range</a> <sup>1084</sup>	
	<a href="#">Text Nodes</a> <sup>1100</sup>	<a href="#">Compare Text</a> <sup>1100</sup>
		<a href="#">Contains Text</a> <sup>1101</sup>
		<a href="#">Date To Text</a> <sup>1102</sup>
		<a href="#">Leading Zeros</a> <sup>1103</sup>
		RegEx Text
		RegEx Compare
		<a href="#">Text Combiner</a> <sup>1106</sup>
	Vector	Distance 1D
		Distance 2D
		Distance 3D
<a href="#">Output</a> <sup>1106</sup>	Controls	<a href="#">Angular Display</a> <sup>1109</sup>
		<a href="#">Bar Graph</a> <sup>1111</sup>
		<a href="#">Digital Display</a> <sup>1114</sup>
		<a href="#">Label</a> <sup>1116</sup>
		Graph Display
		<a href="#">Fader</a> <sup>1116</sup>
		<a href="#">Textbox</a> <sup>1135</sup>
		<a href="#">Page</a> <sup>1121</sup>
		<a href="#">Video Player Time</a> <sup>1139</sup>
		<a href="#">Video Player Volume</a> <sup>1140</sup>
	Connections	<a href="#">Art-Net</a> <sup>1110</sup>
		<a href="#">COM Port ASCII Stream</a> <sup>1113</sup>
		<a href="#">COM Port Message</a> <sup>1112</sup>
		<a href="#">DMX Link Out</a> <sup>1114</sup>
		<a href="#">Midi Note On/Off</a> <sup>1117</sup>
		<a href="#">Midi Raw Message</a> <sup>1118</sup>
		<a href="#">Midi Value</a> <sup>1119</sup>
		<a href="#">SerialLink</a> <sup>1131</sup>
		<a href="#">TCP Message</a> <sup>1133</sup>
		<a href="#">TCP ASCII Stream</a> <sup>1134</sup>
		<a href="#">UDP Message</a> <sup>1136</sup>
		<a href="#">UDP ASCII Stream</a> <sup>1137</sup>
	File System	<a href="#">Excel Writer</a> <sup>1115</sup>
	Generic	<a href="#">Mouse</a> <sup>1120</sup>
		<a href="#">Script</a> <sup>1129</sup>
		<a href="#">Variable</a> <sup>1138</sup>
		<a href="#">Value</a> <sup>1138</sup>
	Pandoras Box	<a href="#">Device Control</a> <sup>1122</sup>

		Device Export To Sequence
		Layer Control
		Rotation Wrap
		Layer Shuffle
		<a href="#">Sequence Control</a> <sup>1123</sup>
		<a href="#">Sequence Seek</a> <sup>1124</sup>
		<a href="#">Text</a> <sup>1125</sup>
		<a href="#">Text Unicode</a> <sup>1126</sup>
<a href="#">Scripts</a> <sup>1140</sup>	<b>Action</b>	
	<a href="#">COM</a> <sup>1141</sup>	
	<a href="#">TCP</a> <sup>1142</sup>	
	<a href="#">UDP</a> <sup>1143</sup>	
	<a href="#">Phidget IR</a> <sup>1144</sup>	
	<a href="#">Phidget RFID</a> <sup>1145</sup>	

## 17.4.1 CREATING AND SETTING UP NODES

To create a node

- open the node menu from the main toolbar or
- right-click anywhere in the empty main background, go to "Create" and "Nodes"
- use the keyboard shortcut Alt+N

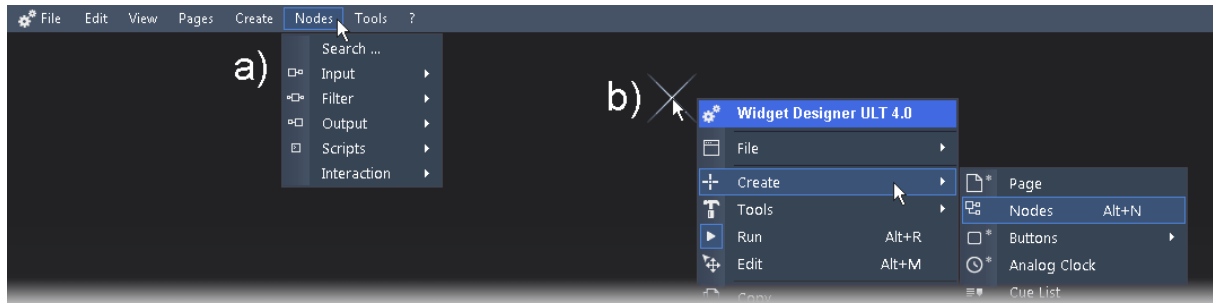

...and choose the desired node. The nodes are attributed to five node types: [Inputs](#)<sup>980</sup>, [Filters](#)<sup>1070</sup>, [Outputs](#)<sup>1106</sup> and the more advanced [Scripts](#)<sup>1140</sup> and [Interactions](#)<sup>1146</sup>. Some categories are sub-divided once more in order to make it easier and faster to find the nodes you are looking for. The table on the [last](#)<sup>959</sup> page lists all categories and nodes. If you know how your node is called, it may be faster to click on "Search" and start typing, the drop-down will suggest you possible nodes.

### Node types

**Input** nodes provide numeric or text based input values.

For example the Mouse or Joystick Input node provides you with an X&Y value.

This value might be related to screen coordinates based on your local display resolution 1024x768.

**Filter** nodes are used between Input and Output nodes, they recalculate the input value.

For example you might want to map the mouse motion to the 16bit value range of a layer in Pandoras Box between -8 and +8.

To resolve this you simply connect a Range Filter node to the Mouse Input and tell the Range Filter to recalculate the range from {0 to 1023} to {-8 to +8}. This is all it takes, this example is described step-by-step in this short [tutorial](#)<sup>967</sup>.

**Output** nodes are used to send values out.

They receive an incoming value (from Input nodes directly or Filter nodes) and -according to their category- send them to another external device, or to Pandoras Box, or to a control used in Widget Designer itself.

For example, you if you connect a Range Filter node with a Layer Output node, you can set up in the Layer Output node that the Range value should be send to the X Position parameter of a given layer.

**Script** nodes execute your customized script; they are triggered through a certain action.

They cannot be linked to other nodes, they are stand-alone. One could also say they are a fixed combination of an Input node to several Script Output nodes. This makes them very performance saving. In detail, Script nodes execute directly customized scripts as soon as a chosen action happens within Widget Designer. This can be, for example, a certain ASCII or Byte value coming in through the local COM port. One single Script node would combine one ASCII value with the first script and another ASCII value with another script and so on. Another type of (incoming) trigger can be an Action (e.g. a button is clicked, a fader changes the value etc.) or even a Gesture (e.g. Swipe Up) that is recognized in a tool like the AirScan.

**Interaction** nodes execute an underlying application that enables to interact with a remote system.

They cannot be linked to other nodes, they are stand-alone. Each Interaction node has a special function that would require a complex node and command combination. For example:

- they send the mouse or touch events happening on the local system to another system, or

- they use the local mouse or touch events to draw on a [Canvas Asset](#)<sup>250</sup>, or
- they watch a folder on the local hard drive and add new files to a Pandoras Box project plus append it to a [Playlist](#)<sup>229</sup>



Once you have chosen a node, the mouse cursor will change to a crosshair icon, telling you that you are in the [operating mode](#)<sup>869</sup> called "create mode". Wherever you left-click now, the chosen node is generated. You may click again, to generate a second node from the same type.

The small number in the upper left corner is the node's ID.

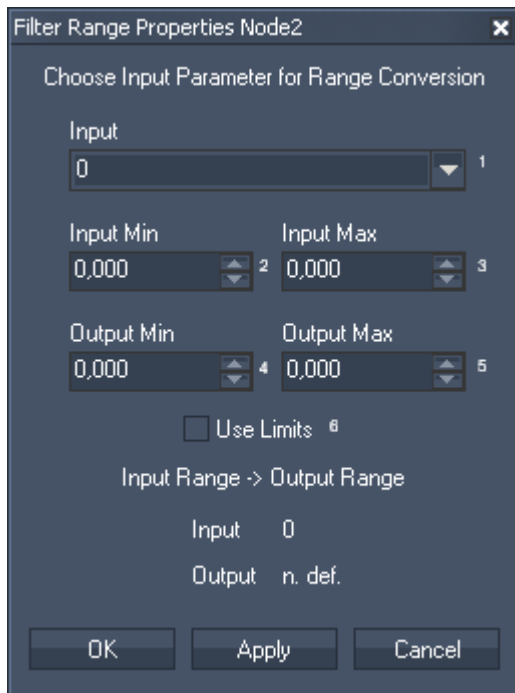

If you want to set up the properties of the newly built node, right-click on it and choose the menu entry "Item Properties" or press [Alt+P] whilst being in the edit / move mode. You may as well double-click it.

The node's property dialog opens up. The left image depicts the properties of a Range Node.

Here you can set up the static parameters and everywhere you see a drop-down list you may choose to pick a source node value output or enter a static numeric value into the text field of the combo box directly.

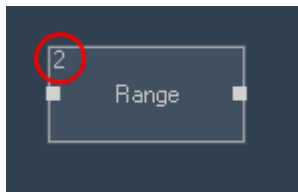

In many nodes you will notice little index numbers next to the input fields. These index numbers are important if you wish to remote control a node source or node value via commands from any other element such as a Custom Script Button or external remote or other output script node. This makes the node system very dynamic and lets you design systems that can change their behavior based on specific input parameters and controls.

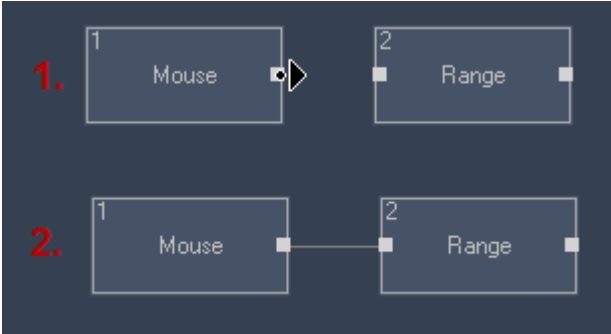

To connect two nodes with each other first switch to the edit mode by pressing ALT+M (you should see a blue outline around the main window and the mouse cursor differs from the standard mouse icon). Now, left-click and drag from the source node output pin to the target node and release the left mouse button.

The connection between the node is now displayed as grey line.

It is possible as well to connect nodes on different pages.

To do this press Page-Up or Page-Down on your keyboard when dragging the connect node line to navigate to the desired page.

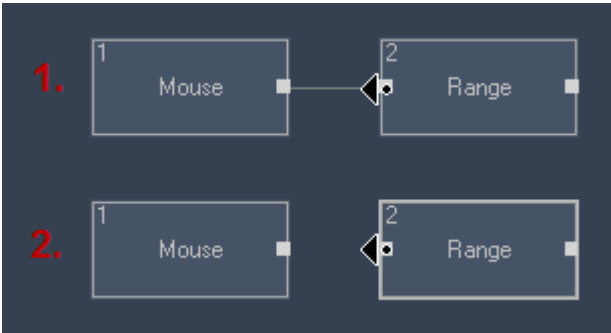

To disconnect a node or free an input or output pin from all its connections you have to be in the edit mode as well. Right-click on the pin that you would like to be reset. Resetting the pins does not reset all node values. Some node parameters are not based on source node values and can be set manually.

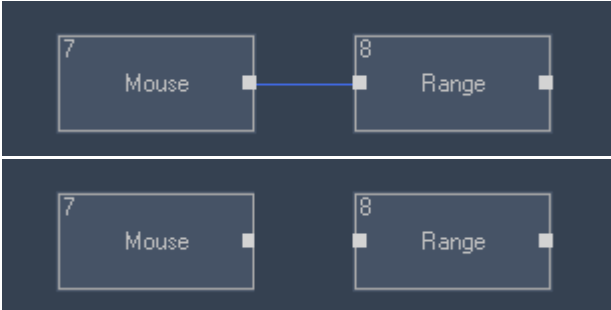

To delete just a single connection between two nodes, switch to the edit / move mode and select the Node Connection by clicking on it. The Node Connection turns blue. Now press [delete] on your keyboard to delete the Node Connection and confirm the upcoming pop up dialog.

To copy and paste nodes, you have to be in the edit / move mode [ALT+M]. To copy a single node, just click on it or drag a window across it. To select multiple nodes, hold [CTRL] pressed while clicking on the nodes or drag a window across all the nodes. Once selected, the nodes may be copied (CTRL+C) and pasted (CTRL+V) within the Widget Designer Project.

All Node Properties will also be copied, as long the Node Sources are copied as well.

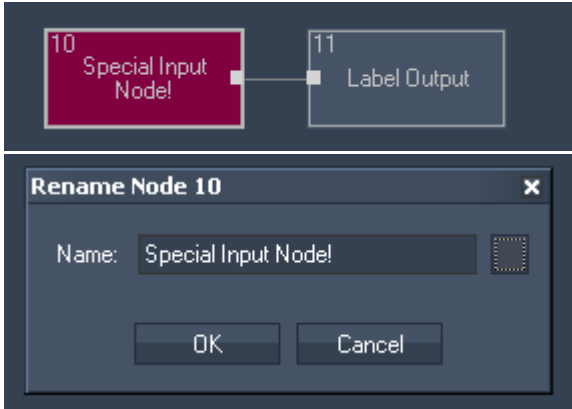

To edit a node's look i.e change the text and the background colour displayed inside the nodes, please position the mouse cursor over the node and press [F2] or right-click in the main GUI and choose "Edit Node". The left depicted dialog opens up.

**Name:**  
Enter the new name and press [OK] to apply the change.

**Background Colour:**  
Click in the little box to the right of the text field to choose a different colour for the node's background.

### 17.4.2 TUTORIAL NODES

Please see here a little example of how to map the X and Y position of a layer in Pandoras Box to a mouse cursor. Moving the mouse cursor to the left /right /upper or lower screen side should result in also moving the layer left / right / up or down.

At first please make sure that the [IP Configuration](#)<sup>865</sup> of your Widget Designer is set up correct to control Pandoras Box.

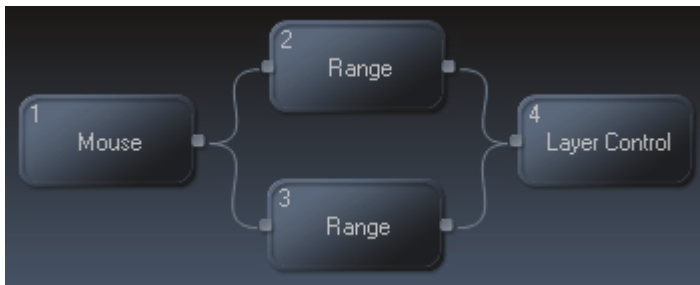

Create three different types of nodes:  
 - one Mouse Input Node ([ALT+N] > Input > Devices > Mouse),  
 - two Range Filter Nodes (one for the translation of the X position, one for the translation of the Y position) ([ALT+N] > Filter > Range),  
 - one Layer Control Output Node.

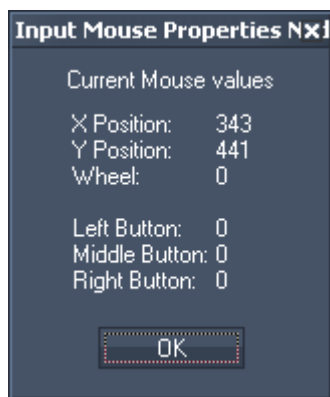

Whilst being in the edit / move mode [ALT +M], connect the nodes as depicted. The range nodes will be the translators between the mouse cursor X and Y position data and the X and Y Position values in Pandoras Box. Now, we need to find out what input range needs to be converted to what output range.

Right-click on the Mouse Node and choose Item Properties. Now the cursor positions are shown.

When your mouse cursor is at the left border of your screen, the mouse X Position shows 0 (at the right border e.g. 1023 is shown, this depends on your screen resolution).

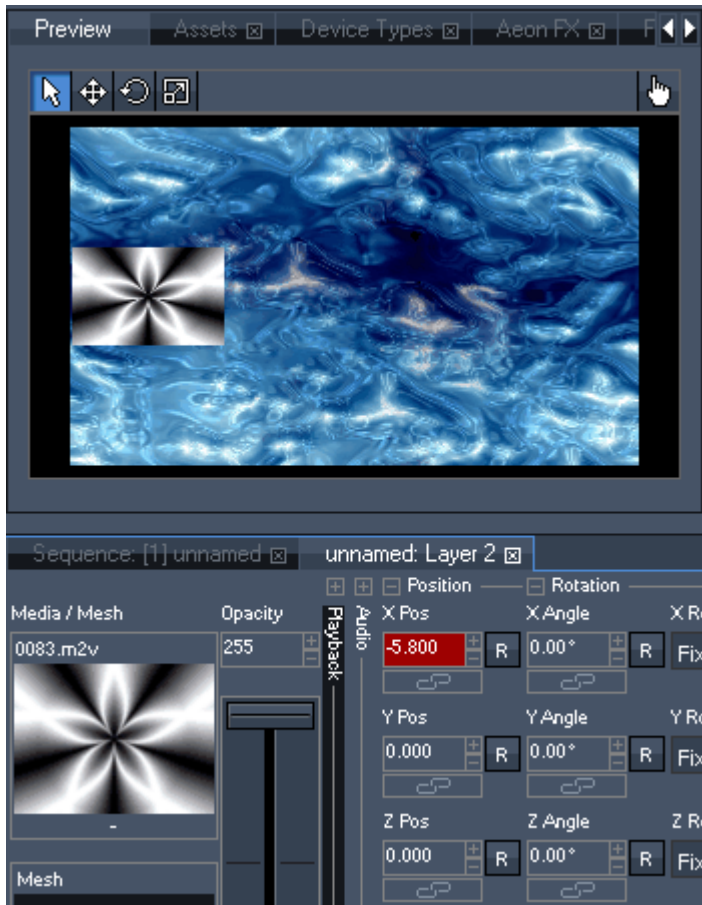

Now, we have a look at the preview window of Pandoras Box Software. Here Layer 2 (the scaled black and white image) is moved to the left side, the X position value for this position is - 5.8 (according to this, when the layer is moved to the right side, the X Position value is +5.8. If you prefer to have the center of the image at the screens border, use -/+ 8 as 16 generic units correspond to one screen width).

The Range Filter Nodes allow to map the mouse position data to Pandoras Box Layer Position data.

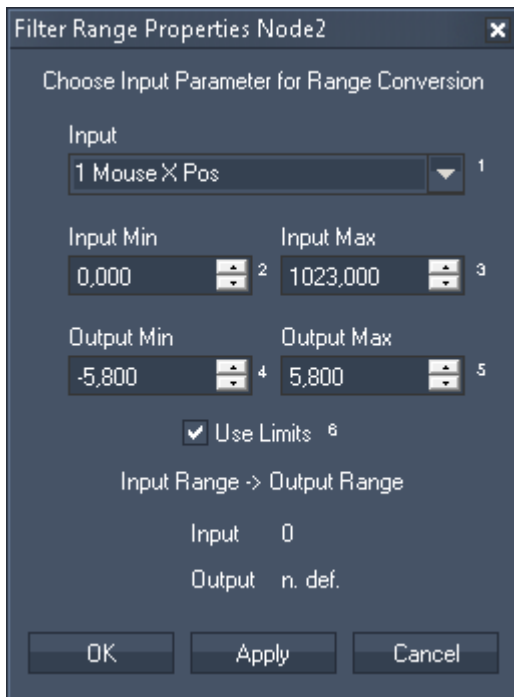

We start with the first Range Node that we set up to map the X position. Please right-click on the first Range Node and choose Item Properties.

Choose "Mouse X Pos" from the list as Input.

The Input Min and Input Max text fields are related to your mouse cursor X position. For Input Min enter the min mouse X position value (keeps the value 0), assign the max mouse X position value for Input Max (read it from mouse input node properties, when your mouse cursor is moved to the right side of your screen).

Output Min and Max are related to Layer 2 in Pandoras Box.

For Output Min enter the value -5.8 (value is read out of Pandoras Box Layer 2 X Position, when the layer is moved to the left side of the screen) and for Output Max enter +5.8 (layers X position value at the right side of the screen). Press Apply / OK. The filter node properties should look like the left example.



After preparing the translation of X position, the second range filter node needs to be set up for translation of Y position. The mouse cursor at top of the screen delivers Y position value 0, at the bottom of the screen it delivers Y position value 767 (according to your screen size). The Layer in Pandoras Box gets the following values in this example: Y position on top of the screen is 4.2, Y position on bottom of the screen is -4.2.



The last thing to do is setting up the Layer Control Output Node. Right-click on it and choose Item Properties.

Enter the Layer ID on top of the dialog. In the first text field enter the site ID, in the second text field enter the layer ID. Tick the check box next to X Pos and choose the Range Output from the list, that is set up for the X position. Tick the check box next to Y Pos and choose the Range Output from the list, that is set up for the Y position. Press Apply / OK.

Move your mouse cursor and the layer now will be mapped to it (make sure you are in the run mode [Alt+R]).

### 17.4.3 SYNTAX TCP- / UDP- / SERIAL MESSAGES

Via TCP-, UDP- and COM Port nodes incoming or outgoing values can be entered as string, decimal or hexadecimal values.

Example:

Let's say, you would like to express a "Carriage Return" at the end of other values. This control character is used in many codes as a command to move to a new line. On a normal keyboard you have the possibility to press the key [Carriage Return], also known as the return key or enter key, the operating system understands this automatically and translates it into the correct code. When writing strings in ASCII or decimal or hexadecimal language you need to translate the command yourself. Please see the DEC HEX ASCII Table below to find the code for the character.

Use [d13] to enter a carriage return as a decimal value.

Use [h0D] to enter a carriage return as a hexadecimal value.

Use [CR] to enter a carriage return as a ASCII symbol.

Please note: Mostly, you need a "Line Feed" command as well. For two commands you may use this syntax: [d13 d10] respectively [h0D h0A] or [CR LF]. Mixed values are also possible, e.g: Example String[CR d10].

Command in a Custom Script Button that sends a string via a TCP connection	Displayed string
TCPSEND,1,Hello world, how are you ?	Hello world, how are you ?
TCPSEND,1,Hello world,[CR LF]How are you [d191]	Hello world, How are you ¿

DEC	HEX	ASCII Symbol	Description
0	0	NUL	Null char
1	1	SOH	Start of Heading
2	2	STX	Start of Text
3	3	ETX	End of Text
4	4	EOT	End of Transmission
5	5	ENQ	Enquiry
6	6	ACK	Acknowledgment
7	7	BEL	Bell
8	8	BS	Back Space
9	9	HT	Horizontal Tab
10	0A	LF	Line Feed
11	0B	VT	Vertical Tab
12	0C	FF	Form Feed
13	0D	CR	Carriage Return
14	0E	SO	Shift Out / X-On
15	0F	SI	Shift In / X-Off
16	10	DLE	Data Line Escape

DEC	HEX	ASCII Symbol	Description
17	11	DC1	Device Control 1 (oft. XON)
18	12	DC2	Device Control 2
19	13	DC3	Device Control 3 (oft. XOFF)
20	14	DC4	Device Control 4
21	15	NAK	Negative Acknowledgement
22	16	SYN	Synchronous Idle
23	17	ETB	End of Transmit Block
24	18	CAN	Cancel
25	19	EM	End of Medium
26	1A	SUB	Substitute
27	1B	ESC	Escape
28	1C	FS	File Separator
29	1D	GS	Group Separator
30	1E	RS	Record Separator
31	1F	US	Unit Separator
32	20		Space
33	21	!	Exclamation mark
34	22	"	Double quotes (or speech marks)
35	23	#	Number
36	24	\$	Dollar
37	25	%	Procenttecken
38	26	&	Ampersand
39	27	'	Single quote
40	28	(	Open parenthesis (or open bracket)
41	29	)	Close (or close bracket)
42	2A	*	Asterisk
43	2B	+	Plus
44	2C	,	Comma
45	2D	-	Hyphen
46	2E	.	Period, dot or full stop
47	2F	/	Slash or divide
48	30	0	Zero
49	31	1	One
50	32	2	Two
51	33	3	Three

DEC	HEX	ASCII Symbol	Description
52	34	4	Four
53	35	5	Five
54	36	6	Six
55	37	7	Seven
56	38	8	Eight
57	39	9	Nine
58	3A	:	Colon
59	3B	;	Semicolon
60	3C	<	Less than (or open angled bracket)
61	3D	=	Equals
62	3E	>	Greater than (or close angled bracket)
63	3F	?	Question mark
64	40	@	At symbol
65	41	A	Uppercase A
66	42	B	Uppercase B
67	43	C	Uppercase C
68	44	D	Uppercase D
69	45	E	Uppercase E
70	46	F	Uppercase F
71	47	G	Uppercase G
72	48	H	Uppercase H
73	49	I	Uppercase I
74	4A	J	Uppercase J
75	4B	K	Uppercase K
76	4C	L	Uppercase L
77	4D	M	Uppercase M
78	4E	N	Uppercase N
79	4F	O	Uppercase O
80	50	P	Uppercase P
81	51	Q	Uppercase Q
82	52	R	Uppercase R
83	53	S	Uppercase S
84	54	T	Uppercase T
85	55	U	Uppercase U
86	56	V	Uppercase V

DEC	HEX	ASCII Symbol	Description
87	57	W	Uppercase W
88	58	X	Uppercase X
89	59	Y	Uppercase Y
90	5A	Z	Uppercase Z
91	5B	[	Opening bracket
92	5C	\	Backslash
93	5D	]	Closing bracket
94	5E	^	Caret - circumflex
95	5F	_	Underscore
96	60	`	Grave - accent
97	61	a	Lowercase a
98	62	b	Lowercase b
99	63	c	Lowercase c
100	64	d	Lowercase d
101	65	e	Lowercase e
102	66	f	Lowercase f
103	67	g	Lowercase g
104	68	h	Lowercase h
105	69	i	Lowercase i
106	6A	j	Lowercase j
107	6B	k	Lowercase k
108	6C	l	Lowercase l
109	6D	m	Lowercase m
110	6E	n	Lowercase n
111	6F	o	Lowercase o
112	70	p	Lowercase p
113	71	q	Lowercase q
114	72	r	Lowercase r
115	73	s	Lowercase s
116	74	t	Lowercase t
117	75	u	Lowercase u
118	76	v	Lowercase v
119	77	w	Lowercase w
120	78	x	Lowercase x
121	79	y	Lowercase y

DEC	HEX	ASCII Symbol	Description
122	7A	z	Lowercase z
123	7B	{	Opening brace
124	7C		Vertical bar
125	7D	}	Closing brace
126	7E	~	Equivalency sign - tilde
127	7F		Delete
128	80	€	Euro sign
129	81		
130	82	,	Single low-9 quotation mark
131	83	<i>f</i>	Latin small letter f with hook
132	84	„	Double low-9 quotation mark
133	85	...	Horizontal ellipsis
134	86	†	Dagger
135	87	‡	Double dagger
136	88	^	Modifier letter circumflex accent
137	89	‰	Per mille sign
138	8A	Š	Latin capital letter S with caron
139	8B	‹	Single left-pointing angle quotation
140	8C	Œ	Latin capital ligature OE
141	8D		
142	8E	Ž	Latin capital letter Z with caron
143	8F		
144	90		
145	91	‘	Left single quotation mark
146	92	’	Right single quotation mark
147	93	“	Left double quotation mark
148	94	”	Right double quotation mark
149	95	•	Bullet
150	96	–	En dash
151	97	—	Em dash
152	98	~	Small tilde
153	99	™	Trade mark sign
154	9A	š	Latin small letter S with caron
155	9B	›	Single right-pointing angle quotation mark

DEC	HEX	ASCII Symbol	Description
156	9C	oe	Latin small ligature oe
157	9D		
158	9E	ž	Latin small letter z with caron
159	9F	Ÿ	Latin capital letter Y with diaeresis
160	A0		Non-breaking space
161	A1	¡	Inverted exclamation mark
162	A2	¢	Cent sign
163	A3	£	Pound sign
164	A4	¤	Currency sign
165	A5	¥	Yen sign
166	A6		Pipe, Broken vertical bar
167	A7	§	Section sign
168	A8	¨	Spacing diaeresis - umlaut
169	A9	©	Copyright sign
170	AA	ª	Feminine ordinal indicator
171	AB	«	Left double angle quotes
172	AC	¬	Not sign
173	AD	Soft	hyphen
174	AE	®	Registered trade mark sign
175	AF	¯	Spacing macron - overline
176	B0	°	Degree sign
177	B1	±	Plus-or-minus sign
178	B2	²	Superscript two - squared
179	B3	³	Superscript three - cubed
180	B4	´	Acute accent - spacing acute
181	B5	µ	Micro sign
182	B6	¶	Pilcrow sign - paragraph sign
183	B7	·	Middle dot - Georgian comma
184	B8	¸	Spacing cedilla
185	B9	¹	Superscript one
186	BA	º	Masculine ordinal indicator
187	BB	»	Right double angle quotes
188	BC	¼	Fraction one quarter
189	BD	½	Fraction one half
190	BE	¾	Fraction the quarters

DEC	HEX	ASCII Symbol	Description
191	BF	¿	Inverted question mark
192	C0		Latin capital letter A with grave
193	C1	Á	Latin capital letter A with acute
194	C2	Â	Latin capital letter A with circumflex
195	C3	Ã	Latin capital letter A with tilde
196	C4	Ä	Latin capital letter A with diaeresis
197	C5	Å	Latin capital letter A with ring above
198	C6	Æ	Latin capital letter AE
199	C7	Ç	Latin capital letter C with cedilla
200	C8	È	Latin capital letter E with grave
201	C9	É	Latin capital letter E with acute
202	CA	Ê	Latin capital letter E with circumflex
203	CB	Ë	Latin capital letter E with diaeresis
204	CC	Ì	Latin capital letter I with grave
205	CD	Í	Latin capital letter I with acute
206	CE	Î	Latin capital letter I with circumflex
207	CF	Ï	Latin capital letter I with diaeresis
208	D0	Ð	Latin capital letter ETH
209	D1	Ñ	Latin capital letter N with tilde
210	D2	Ò	Latin capital letter O with grave
211	D3	Ó	Latin capital letter O with acute
212	D4	Ô	Latin capital letter O with circumflex
213	D5	Õ	Latin capital letter O with tilde
214	D6	Ö	Latin capital letter O with diaeresis
215	D7	×	Multiplication sign
216	D8	Ø	Latin capital letter O with slash
217	D9	Ù	Latin capital letter U with grave
218	DA	Ú	Latin capital letter U with acute
219	DB	Û	Latin capital letter U with circumflex
220	DC	Ü	Latin capital letter U with diaeresis
221	DD	Ý	Latin capital letter Y with acute
222	DE	Þ	Latin capital letter THORN
223	DF	ß	Latin small letter sharp s - ess-zed
224	E0	>	Latin small letter a with grave
225	E1	á	Latin small letter a with acute



DEC	HEX	ASCII Symbol	Description
226	E2	â	Latin small letter a with circumflex
227	E3	ã	Latin small letter a with tilde
228	E4	ä	Latin small letter a with diaeresis
229	E5	å	Latin small letter a with ring above
230	E6	æ	Latin small letter ae
231	E7	ç	Latin small letter c with cedilla
232	E8	è	Latin small letter e with grave
233	E9	é	Latin small letter e with acute
234	EA	ê	Latin small letter e with circumflex
235	EB	ë	Latin small letter e with diaeresis
236	EC	ì	Latin small letter i with grave
237	ED	í	Latin small letter i with acute
238	EE	î	Latin small letter i with circumflex
239	EF	ï	Latin small letter i with diaeresis
240	F0	ð	Latin small letter eth
241	F1	ñ	Latin small letter n with tilde
242	F2	ò	Latin small letter o with grave
243	F3	ó	Latin small letter o with acute
244	F4	ô	Latin small letter o with circumflex
245	F5	õ	Latin small letter o with tilde
246	F6	ö	Latin small letter o with diaeresis
247	F7	÷	Division sign
248	F8	ø	Latin small letter o with slash
249	F9	ù	Latin small letter u with grave
250	FA	ú	Latin small letter u with acute
251	FB	û	Latin small letter u with circumflex
252	FC	ü	Latin small letter u with diaeresis
253	FD	ý	Latin small letter y with acute
254	FE	þ	Latin small letter thorn
255	FF	ÿ	Latin small letter y with diaeresis

#### 17.4.4 NODE COMMANDS

Widget Designer version 4.5 introduces the feature to remote control [nodes](#)<sup>959</sup> with so called "Node Commands". Up until now, commands were "only" for items like a Fader etc. but with the introduction of more advanced nodes, the need arose to control their features with commands too. These more complex nodes allow to enter advanced settings directly in the node and are able to execute functions

themselves. Nodes that have remote controllable functions are for example:

- [Projector Control Input node](#)<sup>1046</sup>
- [OptiTrack ID Tag Input node](#)<sup>1005</sup>
- Watchfolder to PB Playlist Interaction node, etc.

Node commands are executed as any other command. It can be written, for example, in a Custom Script Button to be executed as soon as the button is pressed. Please refer to the chapter "[Script Language](#)<sup>1254</sup>" for more details about commands.

There are two ways to write a node command. One form is a more direct form whilst the other reminds of the structure of other common commands. As with all commands, the original form includes placeholders. By replacing them with according information the command addresses one particular setting from one particular node. So by typing the command, it assumes a definite shape.

### Node commands that access a function of a node

As an example please see the table below. It shows the two basic command forms and examples how they could be filled out.

	Direct node command	Common node command
Basic command to access an function	NodeID.Nodecommand	WDNodeCommand,NodeID,Args0,ArgsN
Examples for: Projector Control	node1.PowerOn node1.PowerOff node1.LampOn ... node1.Input4	WDNodeCommand,1,PowerOn WDNodeCommand,1,PowerOff WDNodeCommand,1,LampOn ... WDNodeCommand,1,Input4
Examples for: Watchfolder to PB Playlist	node2.ResetPlaylist node2.ClearWatchFolder	WDNodeCommand,2,ResetPlaylist WDNodeCommand,2,ClearWatchFolder

The Script Assist feature, offers the available functions for the according node:

- For the direct form: As soon as the dot behind the ID is typed...
  - For the common form: As soon as the comma behind the ID is typed...
- ... , Script Assist looks up what this node is (e.g. a Projector Control) and displays the according commands in a list box. Use the arrow keys (up and down) to select an entry and press Enter. The ESC key hides the list box.

### Node commands that access a parameter of a node

In addition to the purpose of controlling functions, node commands can also be used to assign a value to a parameter within a node. The examples refer to the depicted node chain.

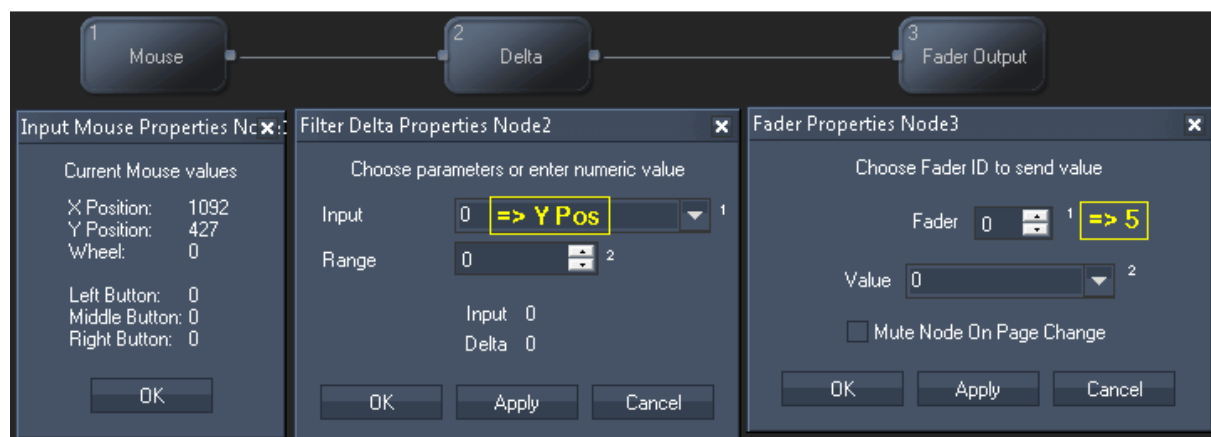

**Example for entering the Fader ID 5 into the Fader Output node:**

The Fader Output node has the NodeID "3" as depicted in the upper left corner in the node. Its parameter for "Fader" is identified with "1" as depicted by the small superscript number next to the parameter field in the Node Properties dialog.

There are 3 possible command forms: (please note that the two direct forms do not support variables yet)

- 1) A direct node command
- 2) A 2nd direct node command
- 3) Common node command

	Node Commands	Examples
1	NodeID.ParamID@Value	node3.1@5
2	NodeID.SetParamValue,ParamID,Value	node3.SetParamValue,1,5
3	WDNodeSetParam,NodeID,ParamID,Value	WDNodeSetParam,3,1,5 WDNodeSetParam,3,1,Variable

**Example for setting the "Input" source in the Delta Filter node to "Y Pos" from the Mouse Input node:**

The Delta Filter node has the NodeID "2" and the Mouse Input node "1". Their IDs are depicted in the upper left corner in the node. The parameter for "Input" (that can accept input values from other nodes) is identified with "1" as depicted by the small superscript number next to the parameter field in the Node Properties dialog. The Mouse Input node provides several values, "Y Pos" is the second of them, thus it gets the ID "2".

	Node Commands	Examples
1	NodeID.ParamID&NodeID,ParamID	node2.1&1,2
2	NodeID.SetParamValue,ParamID,Value	node2.SetParamSource,1,1,2
3	WDNodeSetParamSource,NodeID,ParamID,SourceNodeID,SourceNodeParamID	WDNodeSetParamSource,2,1,1,2 WDNodeSetParamSource,2,1,1,Variable

## 17.4.5 INPUT NODES

Input nodes provide numeric or text based input values. Please see the introductory chapter if you like to learn more about other node types or [how to create and work with nodes](#)<sup>964</sup> in general.

### [AIRBAR](#)<sup>984</sup>

The Airbar Input node provides the following output values: Min, Max, Size and Center. Set up the Airbar via Com Port.

### [AIRSCAN](#)<sup>985</sup>

The AirScan Input node provides the following output values: X1/X2 position, Y1/Y2 position, distance, angle, P1/P2 (Point) enter, P1/P2 leave.

### [AIRSCAN MULTI-POINT](#)<sup>986</sup>

The AirScan Multi-Point Input node provides the position of each detected points as well as his status.

### [ART-NET](#)<sup>987</sup>

The Art-Net input node lets you receive an 8 or 16 bit DMX Value by choosing the desired source Subnet and Universe.

### [AUDIO \(BETA\)](#)<sup>988</sup>

The Audio input Node allows you to define three frequency band passes with a limiter and gate settings.

### [BLACK BOX \(BETA\)](#)<sup>989</sup>

The Black Box input node allows using the 3D position data provided from Cast's device Black Box.

### [BUTTON](#)<sup>991</sup>

The Button input node allows you to intercept Button presses within Widget Designer. Select the Button ID to output the current Button state. The output value is either 0 or 1.

### [CAMERA POINT TRACKER](#)<sup>992</sup>

The Camera Point Tracker Input Interface and the Camera Point Tracker Input Node allows you to track up to 99 objects / points.

### CAMERA TRACKING (Beta)

The CameraTracking Input Interface and Camera Input Node allow you to track up to 8 Tracking points.

### [CLOCK](#)<sup>993</sup>

The Clock node provides the current Date values: Year, Month, Day, Hour, Minute and Second.

### [COLOUR PICKER](#)<sup>993</sup>

The Colour picker input allows you to pick a colour. The values of this RGB colour can be transferred to the Colour FX faders on a layer in Pandoras Box.

### [COM PORT](#)<sup>994</sup>

The Com port input node allows receiving either ASCII or Byte values over a local COM port connection. This input node can output by default any incoming packet as text if no ASCII filter is applied.

### [COM ASCII STREAM](#)<sup>995</sup>

The Com ASCII Stream input node allows receiving ASCII values over a local COM port connection. This input node can output by default any incoming packet as text if no ASCII filter is applied.

### [COM QUERY STRING](#)<sup>996</sup>

The Com Query String input node allows receiving ASCII feedback messages from COM devices over a local COM Port connection.

This input node will output any incoming packet as Text Only, Numeric Only or mixed string.

### [COUNT DOWN](#)<sup>997</sup>

The Count Down input node allows you to set a target time to which it counts down. It will give out both the total amount of remaining years, months, days, hours, minutes, seconds and the Count Down of hours, minutes and seconds.

### [COUNTER](#)<sup>998</sup>

The Counter input node can be set up to continuously count a certain value range in a given amount of time.

The counter can also be set to bounce up and down.

### [DMX LINK IN](#)<sup>999</sup>

The DMX Link input node provides all incoming DMX data via the coolux DMX Link interface.

### [EMAIL](#)<sup>1000</sup>

The Email input node provides all incoming Emails for further processing.

### [ENCODER](#)<sup>1001</sup>

The Encoder input node allows intercepting Encoder Values within Widget Designer.

### [EVENTS](#)<sup>1001</sup>

The Events Input Node provides you information about the last events, current events and next events.

### [EXCEL READER](#)<sup>1002</sup>

The Excel Reader Input Node allows you to readout cells from an excel sheet as text.

### [FACE TRACKING](#)<sup>1003</sup>

The Face Tracker input node allows proceeding the position values delivered by the Face Tracker Tool.

### [FADER](#)<sup>1003</sup>

The Fader input node allows intercepting Fader Values within Widget Designer. Select the Fader ID to output the current fader value.

### [GPS](#)<sup>1004</sup>

The GPS COMPort input node supports the GPGGA data format and is compatible with NMEA 0183.

### [ID Tag](#)<sup>1030</sup> Tracker

The iPhone Remote input node allows to receive the current iPhone remote single and multi-touch values.

ID Tag Data Client

### [IPHONE REMOTE](#)<sup>1030</sup>

The iPhone Remote input node allows to receive the current iPhone remote single and multi-touch values.

### [JOYSTICK](#)<sup>1031</sup>

The Joystick input node allows intercepting standard Windows gaming device input values for axis slider and button input.

### [KINECT](#)<sup>1032</sup>

The Kinect input node allows capturing up to 8 filtered and tracked points/regions of interest via the Kinect device.

### [KINESYS](#)<sup>1032</sup>

The Kinesys K2 Input Node allows you to grab X,Y,Z, Pitch, Tilt & Roll data from a Kinesys K2

### [LABEL](#)<sup>1034</sup>

The Label input node allows using label texts as Input.

### [MEDIA CONTROL](#) <sup>1034</sup>

The Media Control input node allows to intercept the last called Folder and File ID of one or multiple Media Control Panels.

### [MIDI IN](#) <sup>1035</sup>

The Midi input node allows to receive 7bit or 15bit input values as well as Note On/Off and raw byte messages. The midi connection needs to be enabled in the [Connection Manager](#) <sup>1166</sup>.

### [MIDI NOTE CATCH](#) <sup>1036</sup>

The Midi Note Catch node catches and outputs the first incoming Midi Note Message.

### [MOTION DETECTOR](#) <sup>1037</sup>

The Motion Detection input node provides the data given by the Motion Detector Tool for further processing.

### [MOUSE](#) <sup>1038</sup>

The Mouse input node provides the Mouse X&Y position as well as the three button press states Left, Middle and Right.

### [MULTI-TOUCH ITEM](#) <sup>1039</sup>

The Multi-Touch Item input node provides the current state of a Multi-Touch Item (Position, Rotation and Size) as well as the current state of the Layer in PB linked to this Item

### [MULTI-TOUCH PANEL POINT](#) <sup>1040</sup>

The Multi-Touch Panel Point input node provides the current Position of a Point inside a Multi-Touch Panel.

### [ODSL 30](#) <sup>1043</sup>

The ODSL 30 Input node lets you read out distance data from the optical distance measuring sensor ODSL 30 via a local COMPort connection (RS232).

### [OSC](#) <sup>1044</sup>

The OSC Input node lets you receive data via the Open Sound Control Protocol, e.g. from iPhone, iPad or iPod (tested with Touch OSC). A UDP Broadcast Input Connection is required.

### [PAGE](#) <sup>1045</sup>

The Page input node allows using the current page name for further processing.

### [PB DEVICE PARAMETER INPUT](#) <sup>1045</sup>

The PB Device Parameter input node provides feedback values for all layer parameters from a Pandoras Box Master and Backup System for further processing.

### [PING](#) <sup>1046</sup>

The Ping input node gives you feedback in a certain time interval if the specified IP is online.

### [RANDOM](#) <sup>1048</sup>

The Random input node provides a random number on a given update interval and value range.

### [REMOTE TOUCH](#) <sup>1049</sup>

The Remote Touch input node allows processing any incoming remote touch point.

### [RSS](#) <sup>1050</sup>

The RSS input node provides all incoming RSS feeds as Input.

### [SENSOR LINK](#) <sup>1051</sup>

The SensorLink input node provides the absolute, relative and delta values of the encoder inputs, the analog 0-10v inputs and the switch states 1 to 8.

### [SERIAL LINK GPI](#)<sup>1053</sup>

The SerialLink input node provides all 24 GPI contact closure states. Connect a Serial Link via TCP in the [Connection Manager](#)<sup>1166</sup> and set its TCP ID in the input node to listen to the incoming packets.

### [SMS](#)<sup>1054</sup>

The SMS input node provides all incoming SMS for further processing.

### [SPACE NAVIGATOR](#)<sup>1055</sup>

The Space Navigator input node provides the 3D Mouse's X, Y and Z position and rotation data.

### [SMPTE LINK](#)<sup>1055</sup>

The SMPTE Link input node allows reading and using timecode within Widget Designer.

### [TEXTBOX](#)<sup>1056</sup>

The Textbox input node allows intercepting Textbox Values within Widget Designer. Select the Textbox ID to output the current Textbox Value.

### [TEXT READER](#)<sup>1057</sup>

The Text Reader input node allows you to read out text files (.txt) for further processing.

### [TIMAX](#)<sup>1058</sup>

The Timax input node provides XYZ data of the Ubisense Timax tracker.

### [TCP](#)<sup>1059</sup>

The TCP input node allows receiving either ASCII or Byte values based on the selected TCP connection. It can output by default any incoming packet as text if no ASCII filter is applied. The TCP connection is set up in the Connection Manager.

### [TCP ASCII STREAM](#)<sup>1060</sup>

The TCP ASCII Stream input node allows to receive either ASCII values based on the selected TCP connection. It can output by default any incoming packet as text if no ASCII filter is applied.

### [TCP QUERY STRING](#)<sup>1061</sup>

The TCP Query String input node allows to receive ASCII feedback messages from TCP devices over a TCP Port connection

### [TRACKSCAN](#)<sup>1063</sup>

The TrackScan input node provides the integration of a Barcode scanner to read values in mm from 0 to up to 2 km of distances via the local COM Port.

### [TRACKSCAN SERIAL LINK](#)<sup>1064</sup>

The TrackScan SerialLink input node provides the integration of a Barcode scanner to read values in mm from 0 to up to 2 km of distances via the coolux SerialLink device.

### [UDP](#)<sup>1065</sup>

The UDP input node allows receiving either ASCII or Byte values based on the selected UDP connection. It can output by default any incoming packet as text if no ASCII filter is applied. The UDP connection is set up in the Connection Manager.

### [UDP ASCII STREAM](#)<sup>1066</sup>

The UDP input node allows to either ASCII values based on the selected UDP connection. It can output by default any incoming packet as text if no ASCII filter is applied.

### [VALUE](#)<sup>1067</sup>

The Value input node allows you to set a numeric value for further processing.

### [VARIABLE](#)<sup>1068</sup>

The Variable input node allows you to use a variable for further processing.

[WHEEL](#) <sup>1068</sup>

The Wheel input node allows intercepting Wheel Values within Widget Designer. Select the Wheel ID to output the current Wheel value.

[WII](#) <sup>1069</sup>

The Wii input node provides all 4 IR tracking coordinates as well as all Button presses and accelerometer data for up to 4 Wii controllers. The additional Nunchuk and Balance Board are also supported. The Wii controller needs to be connected via Bluetooth as HID.

[XY PANEL](#) <sup>1070</sup>

The XY Panel input node allows intercepting XY Panel Values within Widget Designer. Select the XY Panel ID to output the current XY Panel values.

### 17.4.5.1 AIRBAR

The Airbar Input node provides the following output values: Min, Max, Size and Center. Set up the Airbar via Com Port.

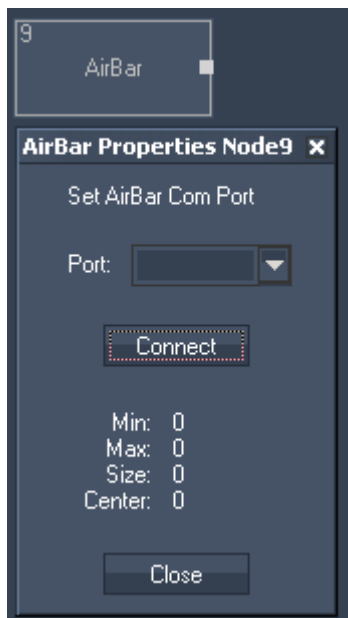

Node Properties:

Port:

Enter the number of the COM Port the Airbar is connected to. Press Connect.

The Node generates the following output:

- Airbar Min Output = Minimum Position from left
- Airbar Max Output = Maximum Position from left
- Airbar Size Output = distance between two points
- Airbar Center Output = center Position between Min and Max.



### 17.4.5.2 AIRSCAN

The AirScan Input node provides the following output values: X1/X2 position, Y1/Y2 position, distance, angle, P1/P2 (Point) enter, P1/P2 leave.

Please set up the AirScan in the [AirScan Tools Menu](#)<sup>1156</sup>.

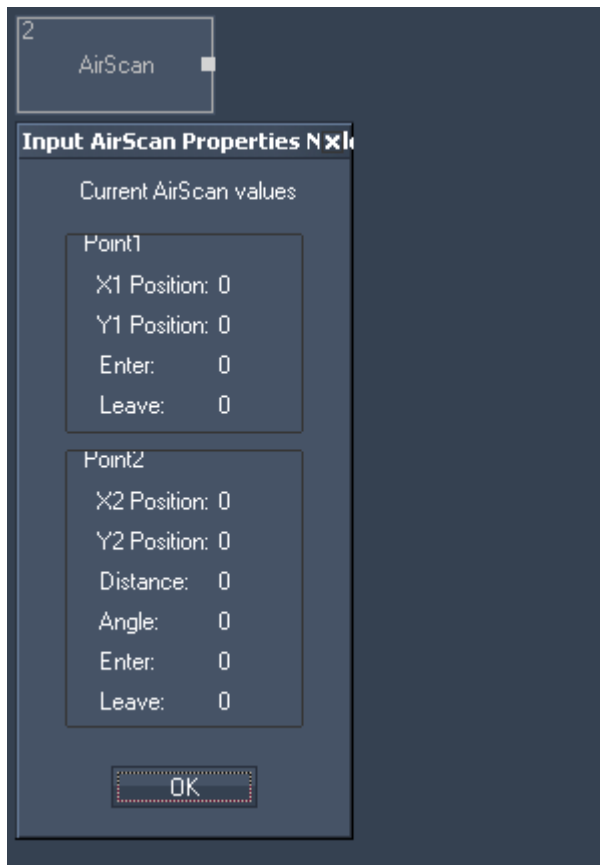

#### Node Properties

The Node generates the following output:

- AirScan X1 Pos,
- AirScan Y1 Pos,
- AirScan X2 Pos,
- AirScan Y2 Pos,
- AirScan Distance (between two points),
- AirScan Angle (between two points),
- AirScan P1 Enter (true or false),
- AirScan P1 Leave (true or false),
- AirScan P2 Enter (true or false),
- AirScan P2 Leave.(true or false).

### 17.4.5.3 AIRSCAN MULTI-POINT

The AirScan Multi-Point Input node provides the positions of each detected points as well as his status, the detected active point count and its orientation.

The AirScan has to be set up in Multi-Point Mode, see [AirScan Tools Menu](#)<sup>1156</sup>.

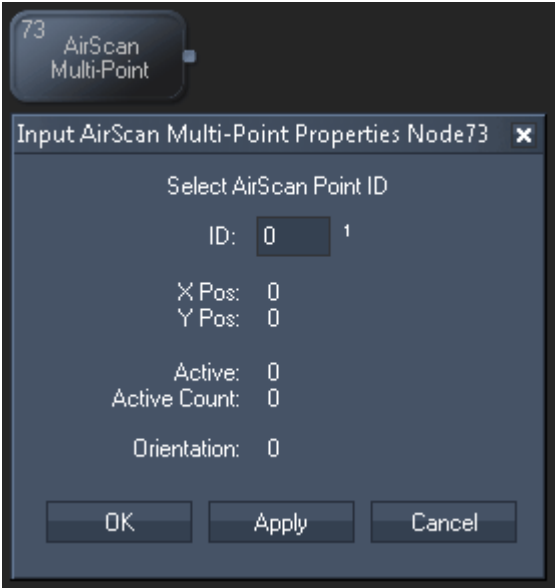

Node Properties:'

ID:  
Enter here the ID of the point whose data you want to use (1-24).

The Node generates the following output:

- X Pos
- Y Pos
- Active (true or false)
- Active Point Count
- Orientation

### 17.4.5.4 ART-NET

The Art-Net input node lets you choose an 8 or 16 bit DMX value by choosing the desired source Subnet and Universe.

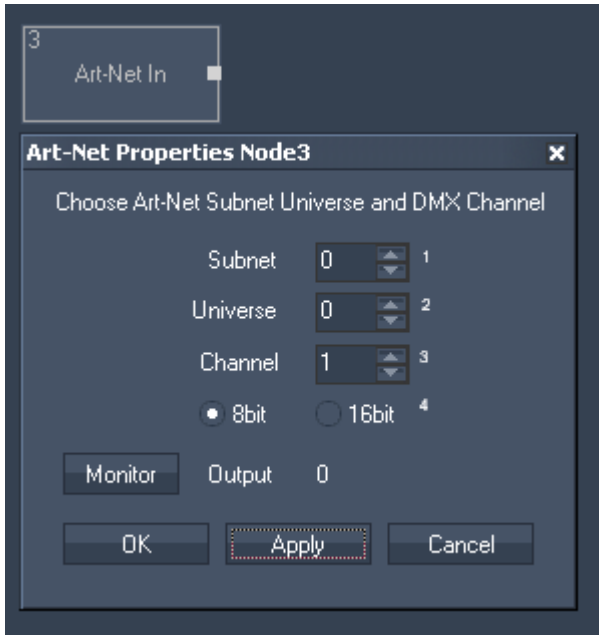

Node Properties:

Subnet:

Enter subnet ID.

Universe:

Enter the Universe ID.

Channel:

Enter the Channel ID.

8bit / 16 bit:

Choose if you want to get a eight or sixteen bit DMX value.

Monitor:

Click here to open the [Art-Net Monitor<sup>1177</sup>](#).

Confirm your settings by pressing OK or Apply.

The Node generates the following output:

- Art-Net In DMX Channel.

### 17.4.5.5 AUDIO (BETA)

The Audio input node allows you to define three frequency band passes with a limiter and gate settings.

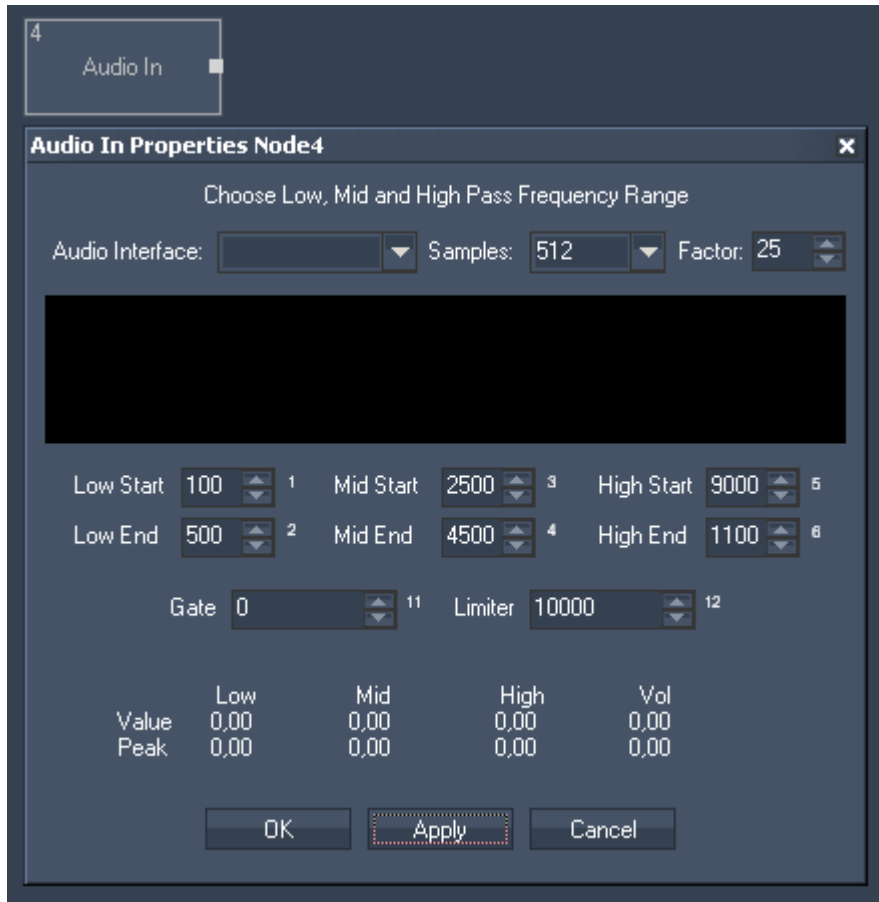

Node Properties:

Audio Interface:

Choose your Audio Interface from the list.

Samples:

Enter the amount of used samples.

Define the three frequency band passes (Low, Mid, High) by entering their Start and End frequency.

Limiter:

Set the limit for upper peak.

Confirm your settings by pressing OK or Apply.

The Node generates the following output:

- Audio In Low,
- Audio In Low Peak,
- Audio In Mid,
- Audio In Mid Peak,
- Audio In High,
- Audio In High Peak,
- Audio In Volume,
- Audio In Volume Peak.

### 17.4.5.6 BLACK BOX (BETA)

The Black Box input node allows using the 3D position data provided from Cast's device Black Box.

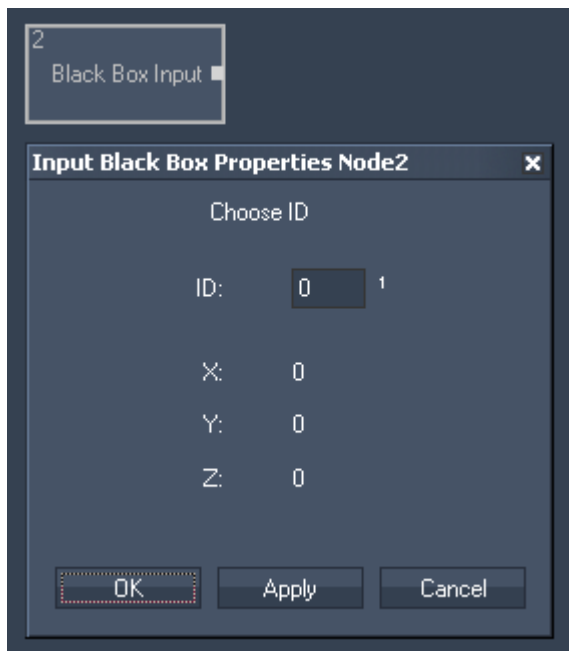

Node Properties:

ID:

Enter the ID.

The Node generates the following output:

- Black Box Input X,
- Black Box Input Y,
- Black Box Input Z.

### 17.4.5.7 CALIBRATION LINK

The Calibration Link Input node allows to communicate with the Calibration Link or a NET Link equipped with fibre input boards. Please see more information in the chapter covering the [NET Link](#)<sup>[747]</sup>.

On the one hand the node receives information send from the 16 fibre inputs, hence, it provides this data to other nodes in Widget Designer. On the other hand, it allows to configure the device and send commands to it.

The [NET Link Input node](#)<sup>[1040]</sup>, the [Relay Output node](#)<sup>[1126]</sup> and the tool "[Projector Calibration Manager](#)"<sup>[1236]</sup> might also be of interest for you.

Create > Nodes > Input > Devices > Calibration Link

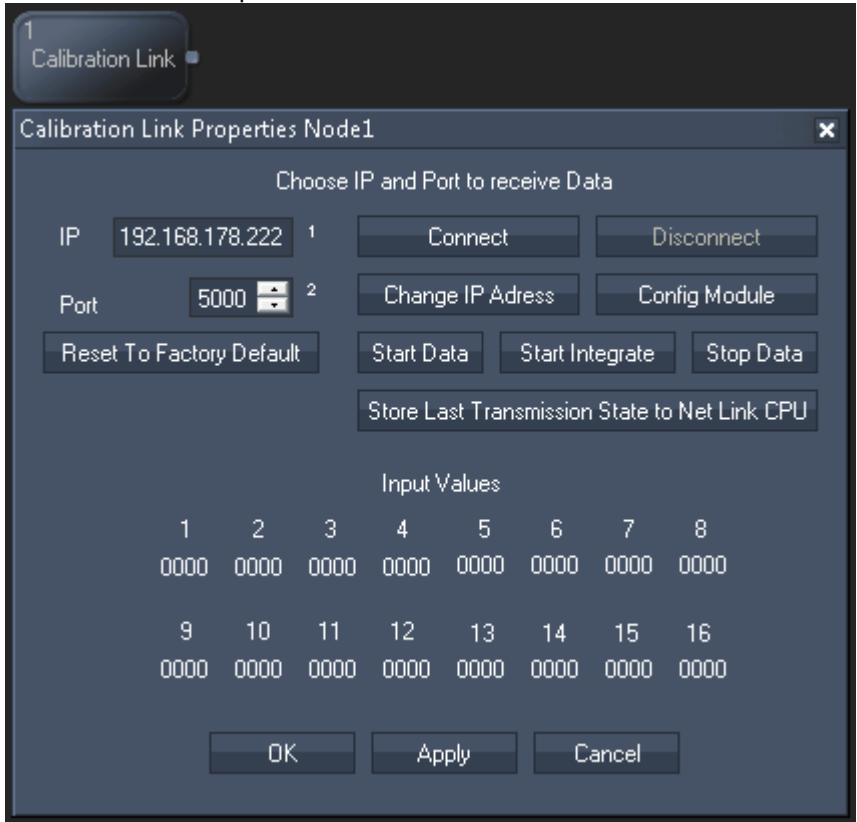

**Node properties**

**IP and Port**

Enter the correct IP address and port from the NET Link's processor or from the Calibration Link.

**Reset To Factory Default**

This buttons resets the above settings in the Widget Designer interface. To reset the device itself (to the IP address 192.168.178.222 and the port to 5000), hold the "Reset" button down whilst plugging the power into the device. Release the button again.

**Connect / Disconnect**

Before starting to communicate with the device, for instance receive data, the node must be connected to the device. The connection itself consumes no performance.

**Change IP Address**

This button opens a new dialog whereto you may enter another IP address and port for the device. Power-cycle the device to apply the changes.

**Config Module**

A NET Link / Calibration Link is configured by coolux as you have ordered it. However, if you have changed some input / output boards, the processor must be configured in terms of giving him the information which boards are connected to it. Click the "Config Module" button to open a new dialog where you may choose the according boards per processor connection. Find more details in the [NET Link hardware chapter](#)<sup>747</sup>.

**Start Data, Start Integrate and Stop Data**

As soon as data is processed via the network from the device to Widget Designer, performance is drawn. For normal use, click "Start Data" (sets a high data rate). For the use of measuring the light distribution over a longer time period, activate the slower data rate with "Start Integrate".

### Store Last Transmission State to NET Link CPU

Click this button and power-cycle the device if you wish that it remembers whether it should (not) send data as soon as it is powered up.

### Node control

This node allows to be remote controlled via so called [node commands](#)<sup>977</sup>. Node commands access functions from a node and / or set a parameter.

Enter "node", followed by the according ID and a dot and a list will pop up showing all available commands for the node. For instance, `node1.StartData` will execute the function automatically without the need of opening the Item Properties dialog and clicking the according button manually. In addition, the node properties with a parameter ID (the small superscript number) can be edited via the commands `WDNodeSetParam,NodeID,ParamID,Value` or `nodeID.ParamID@Value`.

### Node output values

The node generates the following output:

- Value 1 to 16 (0 - 1023)
- Connected

### 17.4.5.8 CUSTOM SCRIPT

The Custom Script Input node allows you to intercept [Custom Script Button](#)<sup>884</sup> presses within Widget Designer. Select the CS Button ID to output the current click state. The output value is either 0 or 1. Please note that the output stays at 1 as long as the button is hold down. If you like to count for example how many times a button was used, you need the information when it was clicked, not how long it was hold down. This can be achieved with the help of other filtering nodes, e.g. [Delta](#)<sup>1077</sup> and [If](#)<sup>1079</sup> node.

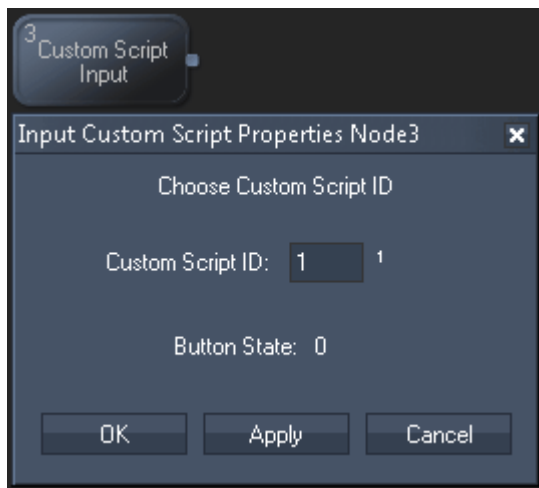

Node Properties:

Custom Script ID:

Enter here the Custom Script Button ID this node should refer to. Confirm your settings by pressing OK or Apply.

The Node generates the following output:

- Value (True=1, False=0)

### 17.4.5.9 CAMERA POINT TRACKER

The [Camera Point Tracker Interface](#)<sup>1224</sup> and the Camera Point Tracker Input Node allows you to track up to 99 tracking points.

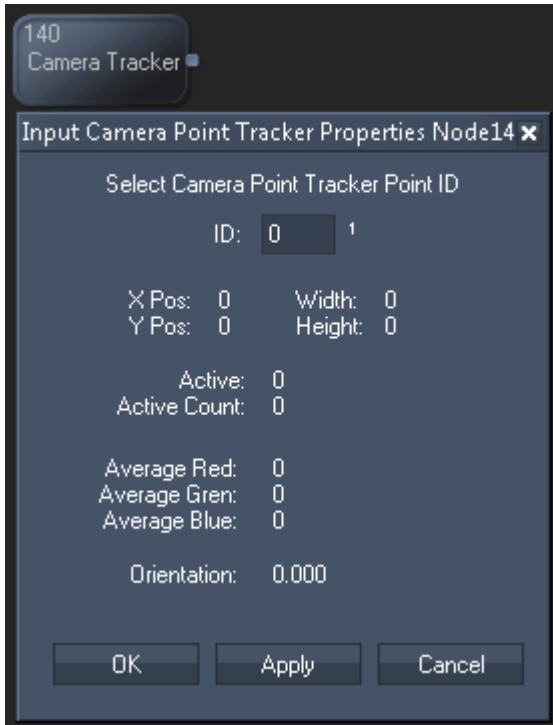

**ID:**  
Select the ID of the Point that is tracked via the Camera Point Tracker.

- The Node generates the following output:
- X Pos
  - Y Pos
  - Active (0 or 1)
  - Active Point Count (amount of current active points)
  - Average Red
  - Average Green
  - Average Blue
  - Orientation
  - Width
  - Height

**Please note:**  
Each tracked point whose data you want to get out for further processing needs its own Camera Point Tracker Input Node.



### 17.4.5.10 CLOCK

The Clock node provides the current Date values: Year, Month, Day, Hour, Minute and Second.

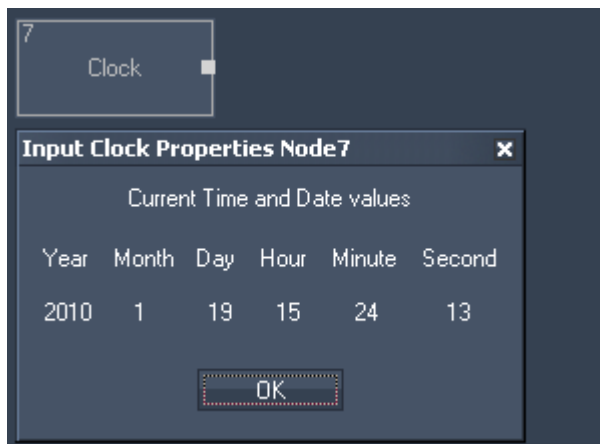

The Node generates the following output:

- Clock Year,
- Clock Month,
- Clock Day,
- Clock Hour,
- Clock Minute,
- Clock Second.

### 17.4.5.11 COLOUR PICKER

The Colour picker input allows you to pick a colour. The values of this RGB colour can be transferred to the Colour FX faders on a layer in Pandoras Box.

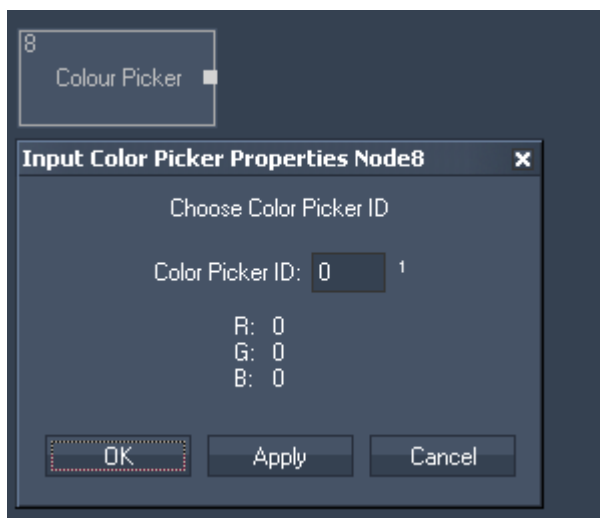

The Node generates the following output:

- Colour Picker Red,
- Colour Picker Green,
- Colour Picker Blue,
- Colour Picker Cyan,
- Colour Picker Magenta,
- Colour Picker Yellow.

### 17.4.5.12 COM PORT

The Com port input node allows receiving either ASCII or Byte values over a local COM Port connection. The COM Port connection needs to be enabled in the [Connection Manager](#).<sup>[1166]</sup> This input node can output by default any incoming packet as text if no ASCII filter is applied.

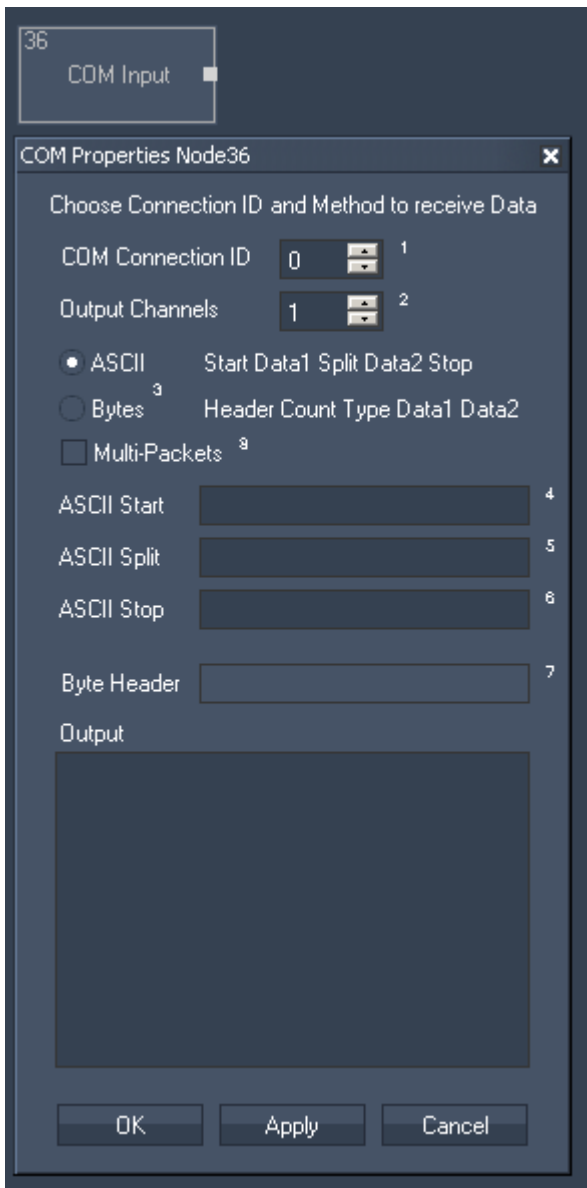

Node Properties:

COM Connection ID:  
Enter the ID of the [COM Port connection](#).<sup>[1166]</sup>

Output Channels:  
Enter the amount of output channels you want to use for this node.

ASCII / Bytes:  
Choose to receive either ASCII or Byte values.

Multi-Packets:  
Check this box to enable Multi-Packets.

ASCII Start, Split, Stop (if ASCII is enabled):  
 Enter the Byte header.

Byte Header (if Byte is enabled):  
 Enter symbols for ASCII Message Start, Split and Stop.

The Node generates the following output:  
 - COM Port Input Value 1 up to Input Value X (X=number of entered output channels).

### 17.4.5.13 COM ASCII STREAM

The Com ASCII Stream input node allows receiving ASCII values over a local COM Port connection. The COM Port connection needs to be enabled in the [Connection Manager](#)<sup>1166</sup>. This input node can output by default any incoming packet as text if no ASCII filter is applied.

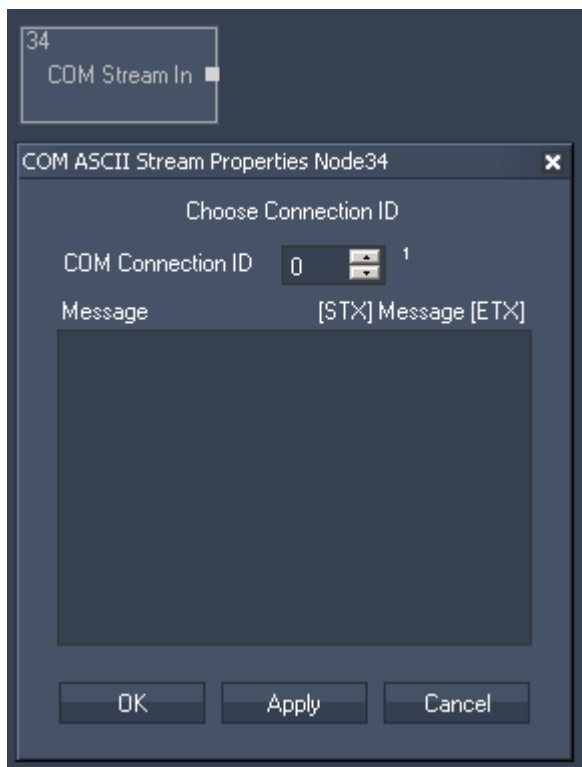

Node Properties:

COM Connection ID:  
 Enter the ID of the [COM Port connection](#)<sup>1166</sup>.  
 The ASCII message between Start [STX] and End [ETX] symbol will be given out.  
 Confirm your settings by pressing OK or Apply.

The Node generates the following output:  
 - COM Stream In String.

### 17.4.5.14 COM QUERY STRING

The Com Query String input node allows receiving ASCII feedback messages from COM devices over a local COM Port connection. The COM Port connection needs to be enabled in the [Connection Manager](#)<sup>1166</sup>.

This input node will output any incoming packet as Text Only, Numeric Only or mixed string.

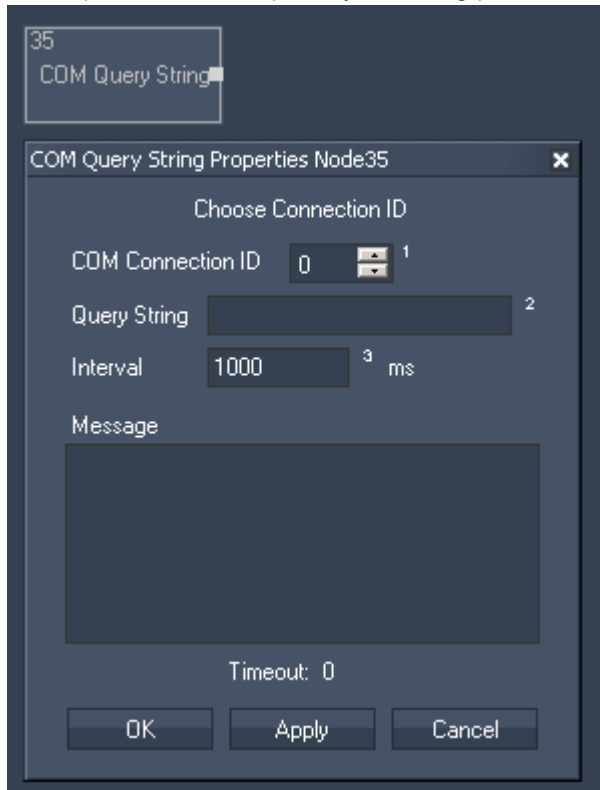

Node Properties:

COM Connection ID:

Enter the ID of the [COM Port connection](#)<sup>1166</sup>.

Query String:

Enter the query string that you want to send to the specified COM Device.

Interval:

Enter the time interval in ms in which the query string will be send to the COM Device.

If you want to query the device manually (e.g. by pressing a Custom Script Button using the command "[WDNodeSetParam, 'NodeID', 'ParamID', 'Value'](#)<sup>1363</sup>"), please set the Interval Time to 0 ms.

Message:

The response of the COM Device will be displayed here. Please note that the responding device needs to send a "carriage return", a "line feed" or an "end of text" at the end of its message. This can be done in [ASCII, decimal or hexadecimal language](#)<sup>970</sup>.

- carriage return is either [CR] or [d13] or [h0D]
- line feed is either [LF] or [d3] or [h3]
- end of text is either [ETX] or [d10] or [h0A]

Timeout:

The Timeout gives you feedback about the connection status. If Timeout is "0", there is no communication with the specified COM Device. If Timeout is "1" the communication works. Confirm your settings by pressing OK or Apply.

The Node generates the following output:

- COM Query String Response,
- COM Query String Text Only,
- COM Query String Numeric Only
- COM Query String Timeout.

### 17.4.5.15 COUNT DOWN

The Count Down input node allows you to set a target time to which it counts down. It will give out both the total amount of remaining years, months, days, hours, minutes and seconds and the Count Down of hours, minutes and seconds.

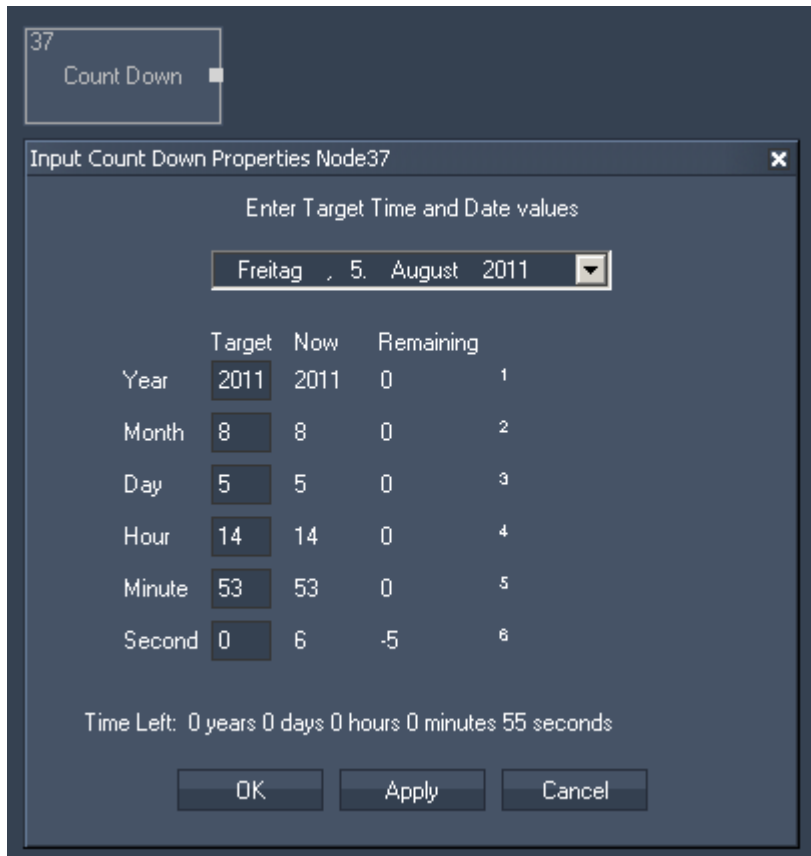

Node Properties:

Target Time and Date values:

Please choose the target date from the list or enter it in the text fields below. Enter here also the time target (hours, minutes and seconds).

Confirm your settings by pressing OK or Apply.

The Node generates the following output:

- Count Down Years Left,
- Count Down Months Left,
- Count Down Days Left,
- Count Down Hours Left,
- Count Down Minutes Left,
- Count Down Seconds Left,
- Count Down CD Hours,
- Count Down CD Minutes,
- Count Down CD Seconds.

### 17.4.5.16 COUNTER

The Counter input node can be set up to continuously count a certain value range in a given amount of time.

The counter can also be set to bounce up and down.

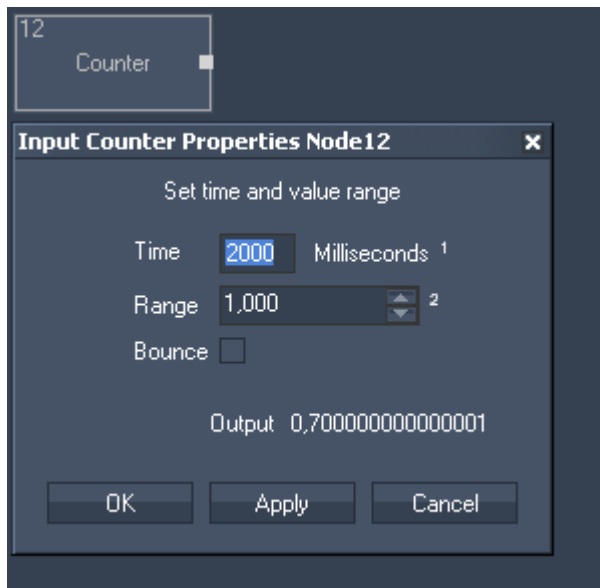

Node Properties:

Time:

Set the amount of time.

Range:

Set the value range.

For example:

To get a counter that counts continuously in 5 seconds from 0 to 5 enter for Time=5000 ms and for Range=5.

To get a counter that counts continuously in 5 seconds from 0 to 10 enter for Time=5000 ms and for Range=10.

To get a bouncing counter (counting continuously from 0 to X and back to 0 etc.) please tick the Bounce check box.

The Node generates the following output:

- Counter Value.

### 17.4.5.17 DMX LINK IN

The DMX Link input node provides all incoming DMX data via the coolux DMX Link interface.

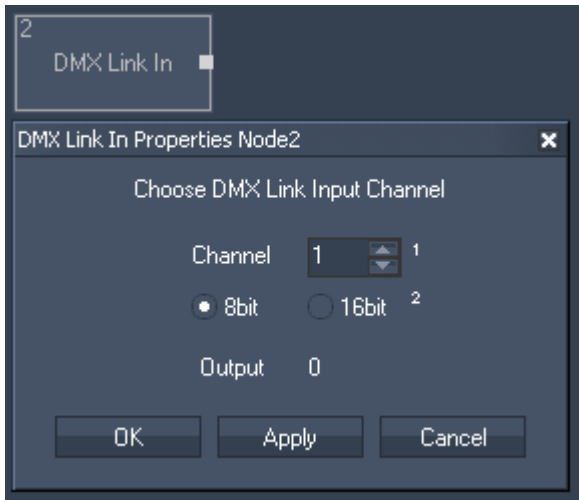

Node Properties:

Channel:  
Choose the DMX channel and if it is a 8bit or 16 bit value.

The Node generates the following output:  
- DMX Link In DMX Value

### 17.4.5.18 DROPDOWNLIST

The DropDownList Input node allows intercepting values from a Widget Designer [Drop Down List](#)<sup>918</sup> control. Select the Drop Down List ID to output the current text value and the index number of the chosen entry.

Create > Nodes > Input > Controls > Drop Down List

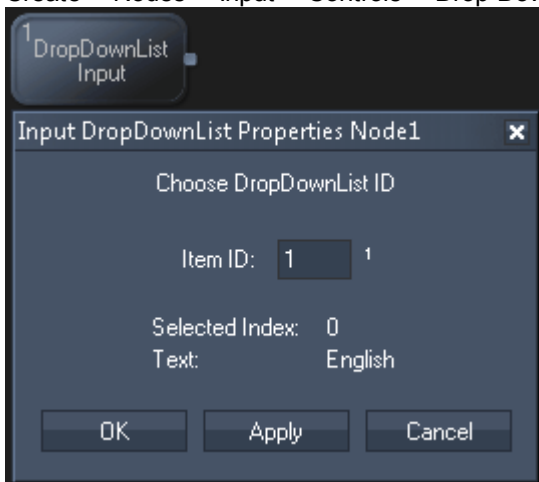

#### Node properties

**Item ID**  
Choose the Drop Down List ID.

## Node output values

The node generates the following output:

- Index (starting with 0!)
- Text

### 17.4.5.19 EMAIL

The Email input node provides all incoming Emails for further processing. Please configure your mail server in the [Email Settings](#)<sup>1214</sup>.

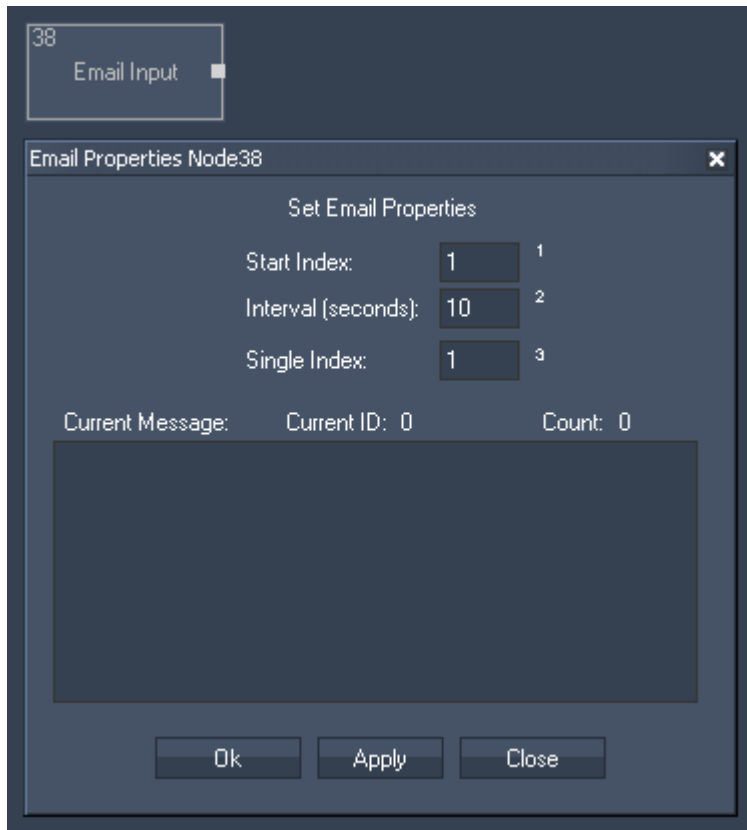

Node Properties:

**Start Index:**

Enter the Index of the email where the cycling should start. This will effect the outputs Current Email and Current ID.

**Interval (seconds):**

All incoming emails will be cycling in the entered amount of time. This will effect the outputs Current Email and Current Email ID.

**Single Index:**

Enter the Index of the email that you want to route to the output Single Email.

The Node generates the following output:

- Email Input Email Count,
- Email Input Last Email,
- Email Input Current Email,
- Email Input Current Email ID,
- Email Input Single Email,



- Email Input RND Email (Random Email).

### 17.4.5.20 ENCODER

The Encoder input node allows intercepting Encoder Values within Widget Designer. Enter the Encoder ID to output the current Encoder value.

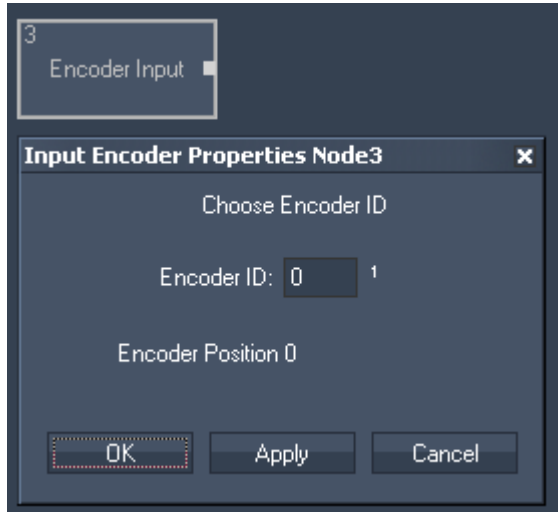

Node Properties:

Encoder ID:  
Enter the Encoder ID.

The Node generates the following output:  
- Encoder Input Value.

### 17.4.5.21 EVENTS

The Events Input Node provides information about the last events, current events and next events. Setup your events in the [Event Editor](#)<sup>1188</sup>.



The Node generates the following output: (Information about the Current Event):

- Events Current Event (Events name),
- Events Current Year,
- Events Current Month,
- Events Current Day,
- Events Current Hour,
- Events Current Second.

The same information is provided for the last and the next event.

## 17.4.5.22 EXCEL READER

The Excel Reader Input Node allows you to readout cells from an excel sheet as text.

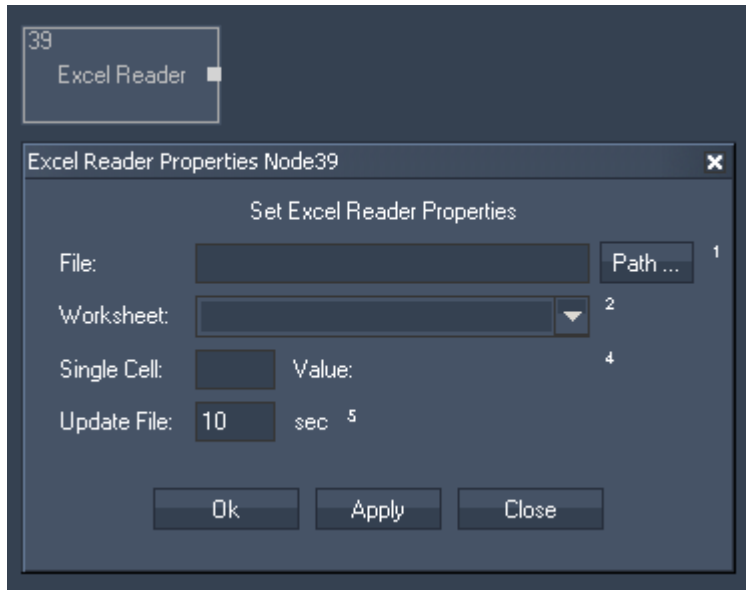

Node Properties:

File:

Use the Path-Button to browse to the document you want to read.

Worksheet:

Press apply after you have selected your file.

In the list select now one of the worksheets your file contains.

Single Cell:

Enter the cell you want to read out, e.g. B11.

Update File:

Enter the update interval.

The Node generates the following output:

- Excel Reader Cell (as String).

**17.4.5.23 FACE TRACKING**

The Face Tracker input node allows proceeding the position values delivered by the [Face Tracker Tool](#) <sup>1222</sup>.

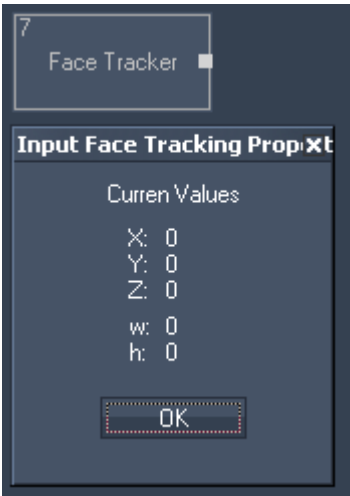

Node Properties:

- The Node generates the following output:
- Face Tracker X (X Pos of bounding box)
  - Face Tracker Y (Y Pos of bounding box)
  - Face Tracker Z
  - Face Tracker w (Width of bounding box)
  - Face Tracker h (Height of bounding box)

**17.4.5.24 FADER**

The Fader input node allows intercepting Fader Values within Widget Designer. Select the Fader ID to output the current fader value.

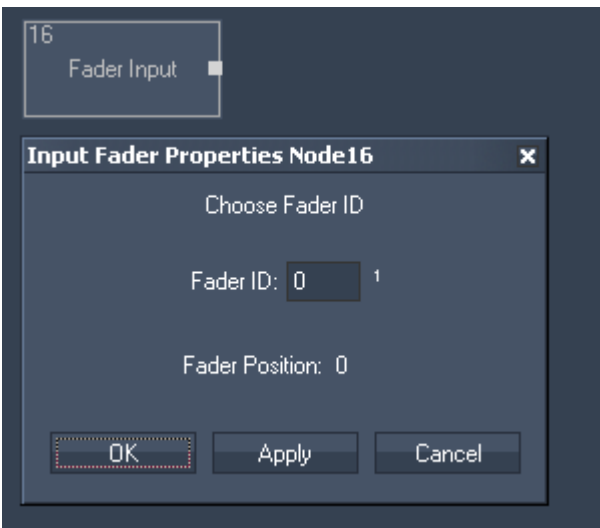

Node Properties:

Fader ID:  
Choose the Fader ID.

The Node generates the following output:  
 - Fader Input Value.

### 17.4.5.25 GPS

The GPS COMPort input node supports the GPGLGA data format and is compatible with NMEA 0183. This node was tested with Navilock USB GPS Input device.

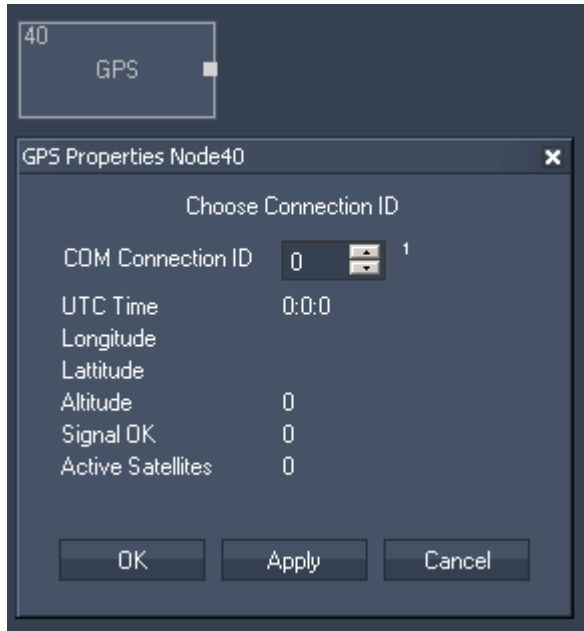

Node Properties:

COM Connection ID:  
 Choose the COM Port your GPS device is connected to.

The Node generates the following output:

- GPS Hours
- GPS Minutes
- GPS Seconds
- GPS Longitudes Text
- GPS Longitudes Degrees
- GPS Longitudes Minutes
- GPS Longitudes Seconds
- GPS LattitudeText
- GPS Lattitude Degrees
- GPS Lattitude Minutes
- GPS Lattitude Seconds
- GPS Altitude
- GPS SignalOK
- GPS Active Satellites

### 17.4.5.26 ID TAG TRACKER

The ID Tag Tracker Input node consists of all settings related to tracking coolux IR ID tags. The node requires the enabled option "OptiTrack Camera Manager" in the [Connection Manager](#)<sup>1166</sup>. It is available in Widget Designer PRO and ULT edition. The tag configuration is included in the Widget Designer STD too.

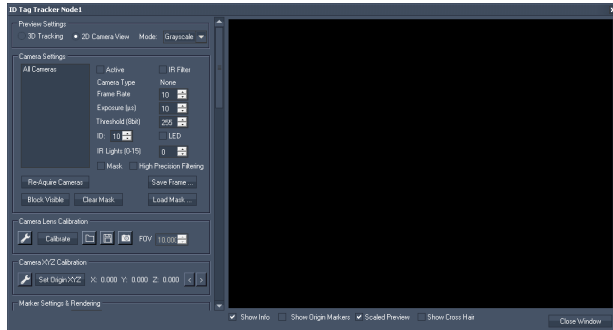

The ID Tag Tracker node includes a lot of settings to set up, adjust and optimize the tracking. It includes the following sections:

- [Preview](#)<sup>1012</sup>
- [Preview Settings](#)<sup>1013</sup>
- [Camera Settings](#)<sup>1013</sup>
- [Camera Lens Calibration](#)<sup>1015</sup>
- [Camera XYZ Calibration](#)<sup>1018</sup>
- [Marker Settings & Rendering](#)<sup>1021</sup>
- [Global Tracking Settings](#)<sup>1022</sup>
- [2D Camera Tracking Settings](#)<sup>1023</sup>
- [3D Tracking Settings](#)<sup>1024</sup>
- [Performance Options](#)<sup>1025</sup>
- [Motion Prediction](#)<sup>1025</sup>
- [MA PSN Output](#)<sup>1026</sup>
- [ID Tag Settings](#)<sup>1027</sup> and [Config ID Tag](#)<sup>1010</sup>

Below the principle of ID camera tracking is explained whilst the next chapter covers the [hardware and environment requirements](#)<sup>1006</sup>. The very last chapter approaches [tracking with moving lights](#)<sup>1028</sup> (automatic follow spot) and how to set up your GrandMA console for it.

### The principle of optical camera tracking and IR ID tags

The general idea behind the optical tracking method with infrared cameras and infrared identification tags -short IR ID tags - is to locate a person or any object, identify it and track its movement. This can be done without any cables attached to the person / object as the tag is pinned on the tracked object and is seen by one or several cameras.



The tag is an active marker with an internal power source: in contrary to a passive marker it does not reflect but emits light itself which allows a higher luminosity (and hereby a maximum range) as well as more flexibility in your stage setup.

In addition to that it can be configured with an identifiable number. Thus it is possible to distinguish two objects from each other, even if they overlap and separate again. This is a huge advantage compared to other camera tracking methods. As well, it allows playful interactive scenarios. For instance it is possible to assign dedicated properties (e.g. content media or color) to dedicated persons or objects. As well, these properties can be shared or swapped if two objects meet.

Currently, you may track up to 256 different IDs. Several tags can be set up with the same ID. The maximum total number of trackable tags depends on the hardware system.

Another requirement in the tag development was allowing it to be hidden in scene pieces, costumes etc. whilst providing good handling on stage. We met this need by reducing the tag to the minimum size

possible, the pure printed circuit board with an onboard power source. Furthermore, the tag can be used out of the box or it can be modified to suit individual needs. That includes different power and / or light sources, e.g. spatially divided from the tag board.

The Widget Designer offers a unique, self-developed tracking method that processes the camera data, allows user adjustments and provides the object's position. With a minimum of three cameras, it is possible to track the 3D position, that is the exact location in a 3D space, expressed through the X-, Y- and Z-position. It is also possible to track only in two dimensions (i.e. a plane), for instance, if one axis does not change. This reduces the camera count to one and other hardware too.

The 2D or 3D data can then be sent (through other Output nodes) to a Pandoras Box playback system, e.g. a Video Layer. Alternatively or in addition, the data can be directly sent to the MA PSN protocol and auxiliary tracking servers.

Besides the position tracking itself the Widget Designer offers the management of the tags properties mentioned above. To fulfill creative tracking scenarios you may adjust settings in the tracking node itself or combine it with everything else, the Widget Designer offers: from the command language and the entire nodes system to other tools and user-controls through to variables and functions. The combination of all this allows to program even the most complex logic.

Hardware-wise the IR ID tracking method requires tags, cameras, (a switch), and a PC running Widget Designer. The surrounding environment must be suitable. The next page explains more about requirements regarding [hardware and the environment](#)<sup>1006</sup>.

#### 17.4.5.26.1 Required Hardware and Tracking Environment

This topic describes the requirements for the IR ID tracking method regarding hardware and environment. For general information about IR ID tracking and links to other chapters please see the topic [ID Tag Tracker](#)<sup>1005</sup>.

Hardware-wise the IR ID tracking method requires tags, cameras, (a switch), and a computer running Widget Designer. The surrounding environment must be suitable.

**The tags** can be purchased through your local coolux distributor. You can choose between an "ID Tag" that provides one configurable ID and the "Quad ID Tag" that provides up to four configurable IDs.

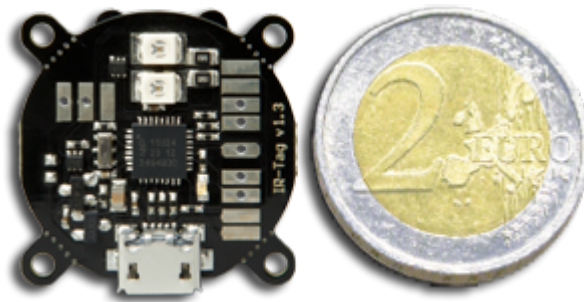

##### (Single) ID Tag

The tag is a printed circuit board with two onboard infrared LEDs, one onboard control LED and a power source. It has a size of 26x26mm and a weight of 10g. The board offers pads for external interfaces, thus it can be modified to suit individual needs, e.g. a spatially divided LED or another power source. Please note that the warranty is not voided by using these pads but malfunctions due to faulty use (too hot soldering, too much power etc.) are not covered!

The onboard or added LEDs blink in a certain pattern according to the set identification number. The LEDs' luminosity can be adjusted whilst only the onboard ones can be powered by 100%. Additional LEDs can be driven with max. 70%, independent from the power source. You may set up to use one or both onboard LEDs and up to three possible additional ones. A brighter tag allows a more distant camera, a more lightened surrounding and a more

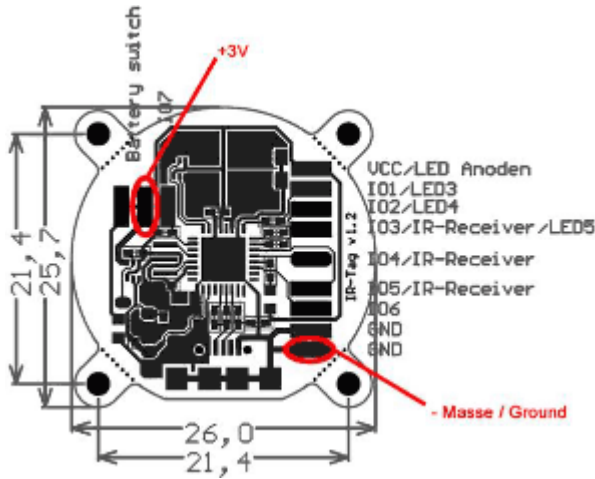

robust tracking. On the other hand it consumes more power.

- The power source can be one of the following three:
- onboard hearing cell holder: holds two button cells; smallest space; feeds one LED with 70%; battery life span approx. 10 hours (as soon as the batteries are activated this span cannot be stopped!)
  - onboard Micro-USB interface: allows to plug the delivered battery (with four 1.5 AA batteries); a battery pack lasts up to 24 hours; auxiliary battery packs should deliver 4.2 to 6.5V
  - custom power source: the pads allow to add another power source with max. 3V

The tag can be [configured](#) <sup>1010</sup> via the onboard Micro-USB interface. Connect the tag via the delivered USB cable (Micro-USB to Standard Type A plug) to your computer running Widget Designer. The configuration involves the number and power of the IR LEDs as well as the brightness of the blue control LED. Further, the blinking mode including the ID can be set up. See below for more details regarding the software settings. The settings are stored in the tag, allowing to unplug it from the computer to change back to the delivered battery pack.

### Quad ID Tag



The quad tag's printed circuit board is covered with a housing. It provides four twist-lock connectors to which you can connect the provided external infrared LEDs. The tags have a cable length of 1,5m. The housing also includes the power source: two AAA-batteries. A power switch and an onboard control LED are also included. It has a size of 110x70x20mm and a weight of 50g.

The connected LEDs blink in a certain pattern according to the set identification number. Each port can be numbered individually. The LEDs' luminosity can also be adjusted. A brighter tag allows a more distant camera, a more lightened surrounding and a more robust tracking. On the other hand it consumes more power.

The tag can be [configured](#) <sup>1010</sup> via the onboard Mini-USB interface. Connect the tag via the delivered USB cable (Mini-USB to Standard Type A plug) to your computer running Widget Designer. The configuration involves the options for the brightness of the IR LEDs as well as the brightness of the blue control LED. Further, the blinking mode including the four IDs can be set up. See below for more details regarding the software settings. The settings are stored in the tag.

**The cameras** supported are third-party motion capture cameras from the OptiTrack system developed by the company [NaturalPoint](#). Please contact an OptiTrack distributor if you are interested as they cannot be purchased through your coolux distributor.

The implemented and supported OptiTrack models are called:

V120:SLIM

V100:R2

Flex3

Flex13

s250e

Prime13

Prime17

Prime41

The camera models differ in resolution, frame rate, field of view (opening angle), max. tracking distance, latency, etc. Please refer to the ["Compare Cameras"](#) web site offered by NaturalPoint.

The question how many cameras are needed and where they need to be positioned depends first of all on the choice to track 2D or 3D. As mentioned above, to capture the 3D position of a tag, a minimum of three cameras must "see" it at any time. For the 2D position, only one camera is needed. Secondly, the maximum distance from a camera to a tag must be defined by combining the camera model's specifications in theory with the stage environment in field. This is influenced by light, the stage setup itself, object movement etc. Please see the below paragraph about "Environment". Afterwards, you may position the cameras in such a way that they cover the area of interest so that one tag is seen by either one or three cameras at any time.

Please keep in mind that the cameras' position should be as static as possible. If they are mounted with other devices such as moving lights on a truss, we strongly advice to check whether any light cue state moves the cameras so much that it worsens the tracking too much.

**An PoE Ethernet switch** is needed when working with cameras with an Ethernet interface, e.g. the s250e or the Prime models. coolux recommends to consider the product recommendation from NaturalPoint. They offer [accessories](#) including switches. As well they provide detailed information about the specification a switch must meet as not all PoE switches are suitable for use with OptiTrack PoE Ethernet cameras. Quoting their [FAQ page](#): " Ethernet cameras require PoE or PoE+ Gigabit (1000 Mbit/s) Ethernet switches. Standard PoE switches must provide a full 15.4 watts to every port simultaneously and PoE+ switches must provide a full 25 watts to every port simultaneously." Please consider that the required power is provided on all ports simultaneously and not only to a subset of ports whilst downgrading other ones. The cameras will not function properly when insufficient power is available to them.

Same applies to the bandwidth per port. "(...) the switch must support Gigabit (1000 Mbit/s) for every port. Connecting multiple PoE switches in a star topology to a non-PoE Gigabit uplink switch is recommended for larger camera counts." It is not recommended to connect more than 4-8 cameras on one switch.

As the Ethernet cameras assign themselves an **IP address**, the switch must not provide a DHCP Server!

**The cabling** between Ethernet cameras and the switch must be done with Cat6 or Cat7 cables; Cat5/ Cat5e/etc not supported. For the USB cameras (e.g. V100:R2) the USB cable length must match the NaturalPoint recommendations. Both camera types, Ethernet and USB, draw their power from the connected "data" cables, an additional power supply and connection is not needed.

Lastly, the **Widget Designer** communicates with the cameras, processes all the (image) data and extracts the object's position in real-time.

Hardware-wise it is recommended to meet at least the specifications from a coolux Workstation. Please contact your local distributor for more detailed information. Next to the network hardware (cables, switches, etc.), the type of Widget Designer hardware (network card, processor...) determine the amount of cameras and tags per system. As a very rough rule of thumb, one Widget Designer hardware and one



LAN (local area network) may process the data of six cameras and 32 tags. Several options may increase or decrease this number.

However, if the limits are reached, it is possible to set up another LAN and a Widget Designer that works as a tracking client. It sends the extracted position data to a main Widget Designer. This WD in return, does the actual tracking processing. It gathers the position data from the clients and assembles them. In addition it manages the objects' properties and runs the entire interactivity. This data containing the interactivity information for dedicated (video) layers or other devices is then send to another system, for instance a Pandoras Box master or another lighting console. It is a very recommended workflow to separate these data flows from each other. This can be either done by using manageable switches or with network cards that offer multiple network adapters / NICs (Network Interface Card, physical RJ-45 connector). All coolux hardware comes standard with a network card providing two NICs; by request we supply four NICs .

An exemplary application with separated data flows is depicted below...

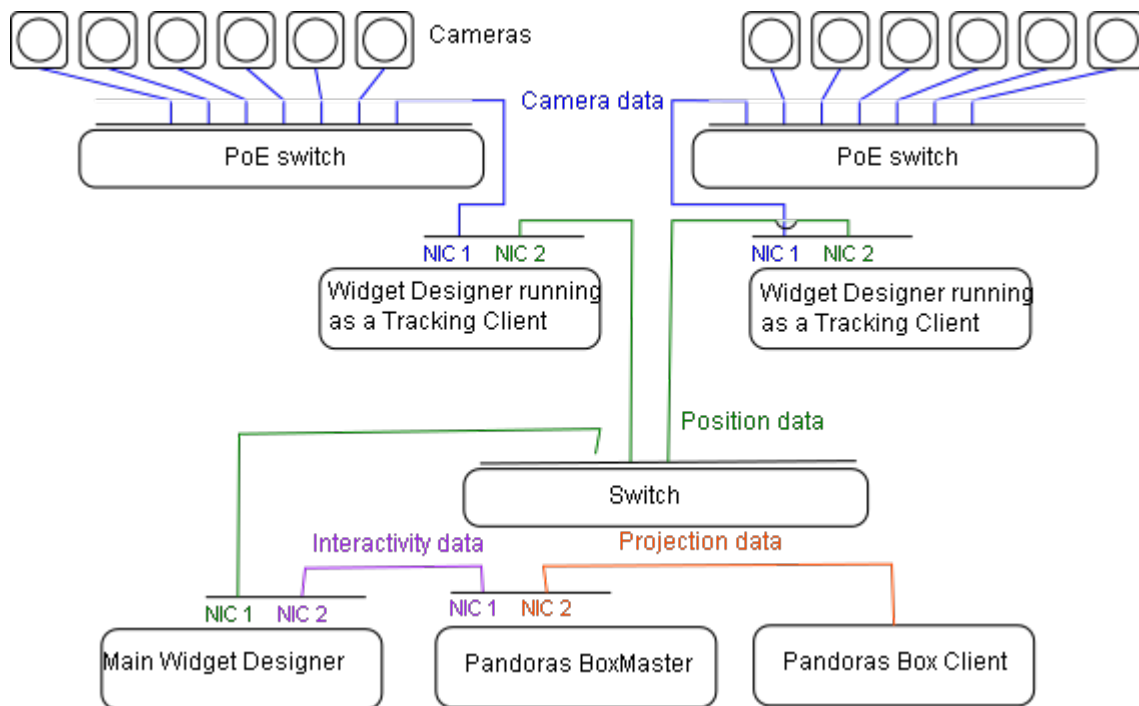

Widget Designer PRO and ULT edition support the tracking node itself and the tag configuration. Widget Designer STD supports only the tag configuration.

The setup for Widget Designer is described in the ["Installation" chapter](#)<sup>865</sup>. If you like to configure tags, connect one via the delivered USB cable (Micro-USB to Standard Type A plug) to your computer. Use the [USB-driver](#) "coousb-driver v6.0.13.0" (or a newer one) to finish the hardware installation of the device. Further steps are described in the chapter ["Config ID Tag"](#)<sup>1010</sup>.

If working with Ethernet cameras, the computer must be set up with a static IP address in a range and subnet mask freely chosen.

If working with USB cameras, please make sure to install the driver NaturalPoint provides.

The user interface offers several settings including the configuration of the tags, the cameras, the tracking itself including the management of objects' properties and finally the system to which all this data is send. The following pages will explain all option in the user interface.

The surrounding **environment** must match the needs of an optical tracking method based on infrared light. In the nature of things, any other infrared light source influences the stability of the tracking system. Please note, that many materials (glass, metal, etc.) reflect infrared light. To reduce light noise, it is possible to adjust the cameras' sensitivity and tags' luminosity. These settings help to get rid of most unwanted light sources but still see the tag's light. In addition, masking is

available. A mask can be used to exclude certain areas from the image a camera sends to Widget Designer, for instance areas outside the stage or too bright areas on stage. However, these areas need to be static and will also absorb the tag's information.

It is highly recommended to schedule sufficient time on site to cope with these interferences. Keep in mind that any changes done to the stage setup and scenery could influence the tracking behavior.

### 17.4.5.26.2 Config ID Tag

This topic describes how to configure a tag software-wise. For general information about IR ID tracking and links to other chapters please see the topic [ID Tag Tracker](#)<sup>[1005]</sup>.



#### (Single) ID Tag

The software configuration of the tag involves to set up the number and power of the IR LEDs as well as the brightness of the blue control LED. Further, the blinking mode including the ID can be set up.

The tag can be configured via the onboard Micro-USB interface. Connect the tag via the delivered USB cable (Micro-USB to Standard Type A plug) to your computer running Widget Designer. If you connect it the first time, and the driver cannot be found automatically, use the [USB-driver](#) "coousb-driver v6.0.13.0" (or a newer one) to finish the hardware installation of the device.

Now, please open the configuration dialog in Widget Designer:

- a) Tools > Connection Manager > section ID Tag Configuration
- b) Nodes > Input > Devices > ID Tag Tracker > section ID Tag Settings



#### Quad ID Tag

The software configuration of the tag involves to set up the brightness of the IR LEDs and the brightness of the blue control LED. Further, the blinking mode including the ID for each port can be set up. Note that it is possible to set each port to an individual ID or to share the same ID.

The tag can be configured via the onboard Mini-USB interface. Connect the tag via the delivered USB cable (Mini-USB to Standard Type A plug) to your computer running Widget Designer. If you connect it the first time, and the driver cannot be found automatically, use the [USB-driver](#) "coousb-driver v6.0.14.0" (or a newer one) to finish the hardware installation of the device.

Now, please open the configuration dialog in Widget Designer:

- Tools > Connection Manager > section ID Tag Configuration

Mode	<p>This influences the maximum ID a tag can hold. It is recommend to choose the smallest mode available that covers the number of tags you use.</p> <p>"4" allows four tags holding the ID 1,2,3 and 4. If you want to use ID 5, you need to choose a higher mode, e.g. 8. The tags transmit their ID with a certain blinking pattern that needs to be seen by cameras. The higher the mode is, the longer this pattern gets. Hence, the more time needs to pass in order to recognize a tag if it (re-)appears in the tracking area.</p> <p>Please note that it is possible to set up several ID tags with the same ID. This does not mean to increase the mode as long as the ID fits into the range. In the section "<a href="#">3D Tracking Settings</a>"<sup>1024</sup> you can set up that "same" IDs should result in one averaged position.</p>
Interval	<p>This influences how fast the above described blinking pattern is transmitted. Per default it is set to 20ms.</p> <p>The lower the frame rate of the used cameras is, the longer an interval needs to be, the slower a tag is recognized. For a frame rate below of 100-120fps an interval of 40 ms is recommended. That applies for most USB cameras.</p> <p>The higher the frame rate of the used cameras is, the shorter an interval can be, the faster a tag is recognized. A frame rate of 120fps allows to lower the interval to 20ms; 150fps allows even 10ms. However, a longer interval still works with fast cameras and is more robust. In theory, a 10ms interval also works for 120fps but in practice this is very prone to error, hence an 20ms interval is better.</p>
ID	<p>The "ID" depends on the "Mode" chosen above and means the identification number of the connected tag.</p>
Power	<p>Choose the power source of your tag.</p> <p>Choose "USB / 3V" if you use the onboard Micro-USB interface with the delivered battery pack or your own 3V power source</p> <p>Choose "A675 Cell" if you use two onboard hearing cells.</p> <p>See more information regarding the power options in the previous chapter "<a href="#">Required Hardware</a>"<sup>1006</sup>.</p>
IR LED	<p>Choose which LEDs should blink. 1 and 2 are the onboard ones. Only the "USB / 3V" power source allows to use all LEDs at the same time.</p>
IR Pulse	<p>Set the minimum and maximum brightness used in the blinking pattern when transmitting the tag's ID. It is recommended to set the minimum to 0. The brighter the maximum is, the higher the tracking distance gets and the more disturbing light is possible. Only the "USB / 3V" power source allows to power the LEDs with 100%.</p>
Blue LED	<p>Set the minimum and maximum brightness used for the blue control LED. If you do not want a blinking LED, set an equal value.</p> <p>The blue LED serves no other purpose than being able to see at first glance whether a tag is on or off.</p>
Save Config	<p>This stores the above settings to the connected ID tag. Now you can unplug it and power it (later).</p> <p>The settings in the dialog are not reset, hence you can plug a new tag to the PC, change only the ID and save all settings to it.</p>

### 17.4.5.26.3 Preview

This topic explains the section "Preview" of the ID Tag node, for general information about IR ID tracking and links to other chapters please see the topic [ID Tag Tracker](#)<sup>1005</sup>.

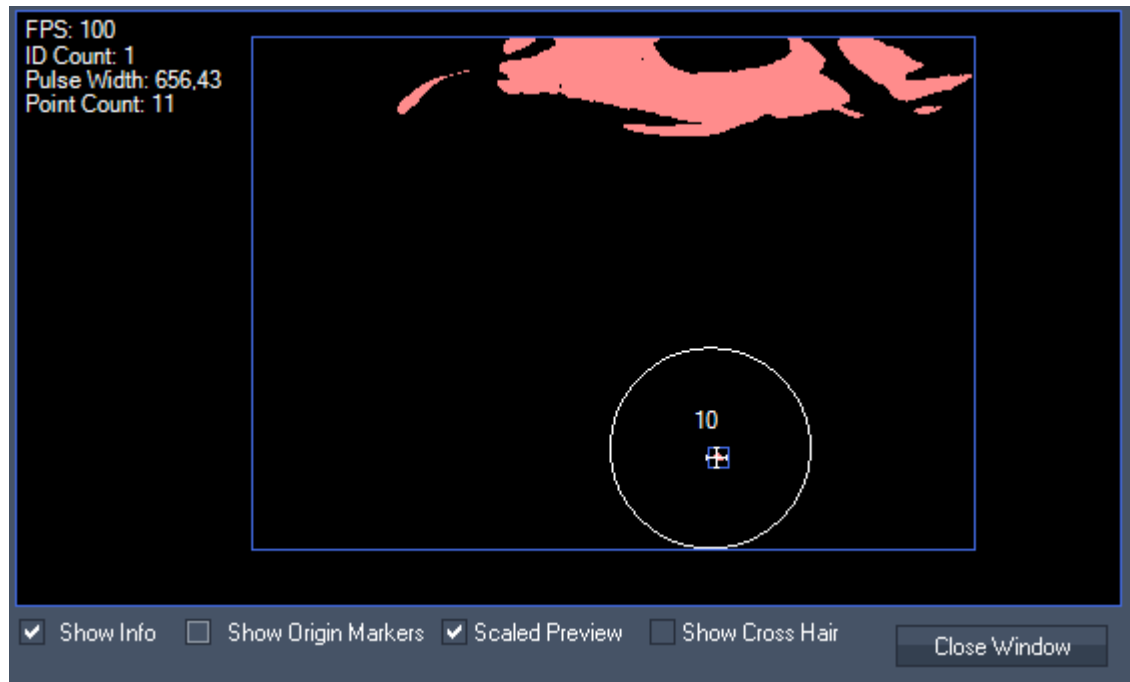

Preview Window	<p>Depending on the options in the section <a href="#">"Preview Settings"</a><sup>1013</sup> this window shows either a camera's image (in grayscale, segment or tracking mode) or the virtual 3D space with all cameras and markers inside. To navigate in the 3D space use the middle mouse button (wheel): Scroll = Zoom, Drag = Pan, ALT+Drag = Rotate. More <a href="#">3D rendering settings...</a><sup>1021</sup></p> <p>If a mask is set up, it is displayed as an blue overlay.</p> <p>If a tag is found, it is displayed with...</p> <ul style="list-style-type: none"> <li>- its ID if possible (here: 10)</li> <li>- a white circle indicating the maximum speed (see "2D Tracking Settings")</li> <li>- another circle underneath the white one, if you change the default minimum distance to another tag (see "2D Tracking Settings")</li> <li>- a white cross indicating the tag's position with the added damping time (see "Prediction Settings").</li> </ul> <p>Please see the below table for detailed information about "Grayscale / Segment / Tracking".</p>
Show Info	<p>This displays the Information in the left upper corner. The frame rate (FPS) depends on the mode chosen: the maximum rate is reached only in tracking mode and is lowered for the other modes. The Point Count informs about the number of valid areas. All valid areas are analyzed whether they hold an ID. If so, their tag ID and circles are displayed.</p>
Show Origin Markers	<p>This displays a red circle at the location from a origin marker when the "Mouse Mode" of the <a href="#">"Camera XYZ Calibration"</a><sup>1018</sup> was used.</p>
Scaled Preview	<p>This toggles between a scaled view of 640x480px and the camera image in its original size (e.g. for the s250e model: 832x832px). A non-scaled view will be shown 1:1 and with scrollbars.</p>
Show Cross Hair	<p>This displays a horizontal and vertical line at the mouse pointer's position. Under certain circumstances it might be useful to see a crosshair overlay in the preview. The center of the image is marked as well as the size of a quarter of a frame. For instance, it is useful for the <a href="#">"Camera Lens Calibration"</a><sup>1015</sup> process.</p>

### 17.4.5.26.4 Preview Settings

This topic explains the section "Preview Settings" of the ID Tag node, for general information about IR ID tracking and links to other chapters please see the topic [ID Tag Tracker](#)<sup>1005</sup>.

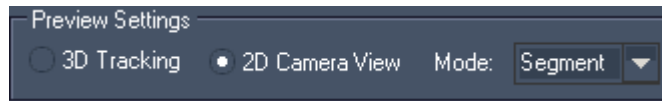

<p>2D Camera View 3D Tracking</p>	<p>Choose what you like to see in the <a href="#">preview</a><sup>1012</sup>.          "3D Tracking" shows a virtual 3D space with visualized camera icons, all tags and a 3D model of your stage if set up in the section "<a href="#">Marker Settings &amp; Rendering</a>"<sup>1021</sup>. To navigate in the 3D space use the middle mouse button (wheel): Scroll = Zoom, Drag = Pan, ALT+Drag = Rotate          The "2D Camera View" shows the real camera image. Here, you may choose between grayscale, segment and tracking mode...</p>
<p>Grayscale Segment Tracking</p>	<p>If the preview is in "2D Camera View" mode, the camera's image is seen as:          - a grayscale image with detailed information (draws most performance)          - a segment image with information reduced to pixels above the setup threshold - all these pixels are examined to wear a tag ID, if they do, a tag is displayed as described in "Preview Window"          - a tracking image with information reduced to pixels found to belong to a tag (draws less performance, each time the node properties are closed, this mode is entered)          The frame rate of a camera (depicted in the corner of the preview) depends on the selected mode. The maximum available rate is only achieved in the tracking mode.</p>

### 17.4.5.26.5 Camera Settings

This topic explains the section "Camera Settings" of the ID Tag node, for general information about IR ID tracking and links to other chapters please see the topic [ID Tag Tracker](#)<sup>1005</sup>.

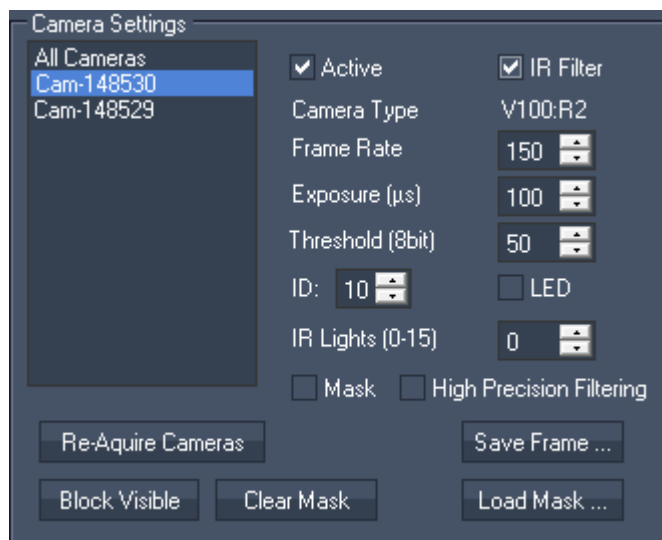

<p>Camera List</p>	<p>All cameras found within the network are listed with their serial numbers. If a camera is missing, try to re-initialize the list (see below). Secondly, check the connection to it, e.g. restart your switch. NaturalPoint offers a tool called "<a href="#">Camera Tester</a>" (also available under C:\Program Files (x86)\coolux\Widget Designer...), if you have problems connecting the Widget Designer to the cameras, try to connect to them using the tool to see whether the problem lies in the physical connection or not.</p>
--------------------	--

	The selection of a single camera or "All Cameras" affects many settings, e.g. the "Frame Rate". Keep in mind, that "All Cameras" overwrites a change to all cameras, even if they were set up individually per camera before"
Re-Acquire Cameras	This button tries to (re-)connect to all available cameras (and removes obsolete cameras). All settings like "Exposure" are kept.
Active	This check box toggles the camera active or inactive. An inactive camera does not contribute its view to the calculation of the tag's position anymore. This can be helpful during setup to find out how "good" a camera matches with other cameras. If a tag jumps far when toggling a camera, it is not setup well. Another necessity for deactivating a camera might be when the connection suddenly became bad or if it's position has changed by accident or something else happened that disturbs the tracking calculation.
IR Filter	This check box influences what light is seen by the camera - only infrared light with a ticked check box or additional visible light if not ticked. You might want to deactivate the filter during setup (e.g. camera position, focus,...) in order to see a camera image containing more information.
Camera Type	This informs about the camera type when a camera is selected from the list, e.g. "V100:R2".
Frame Rate	The frame rate determines how many images are taken per second. For instance, "250" means that 250 images are taken and sent per second. In other words one image has a time frame of $1/250$ of a second = 0.004 sec = 4 ms = 4000 $\mu$ s You may lower the frame rate to save performance. You must not exceed the highest frame rate supported by your camera.
Exposure	The Exposure determines how many microseconds ( $1\mu$ s = $1/1\,000\,000$ of a second = 0.000001 sec) the lens shutter is open for light to pass through it and expose the image. The longer that is, the brighter the image gets, meaning that dark areas will be not black any more but dark-gray whilst light-gray areas will become white. Every pixel that is not black is later on examined to be a potential tag. Hence, adjust the time as short as possible to still see the tag's light but nothing else. Before increasing it, lower the threshold first. Exposure and threshold are engaged to each other! Also, you could increase the brightness of a tag or set up a mask. Note that the exposure time depends on the frame rate and should not be longer than one frame itself.
Threshold	The effect of the threshold is only seen in camera mode "Segment" or "Tracking" as it works "after" the grayscale image. It sets the minimum brightness a pixel from the grayscale image must have in order to be considered as a valid pixel. Valid pixels are displayed in the segment mode as pink pixels and are potential tags. The value range is 0-255. In contrary to the exposure, which should be set to a minimum level, the threshold should be set to a maximum level. The higher the threshold is, the brighter a pixel in the grayscale needs to be in order to be handed over into the segment mode, hence to be examined to be a tag. The less pink pixels you see, the less calculation needs to be done. In short, adjust the exposure as low as possible and the threshold as high as possible to still see the tag's light but nothing else. If you need a brighter image, it is better in regards to the performance, to adjust the threshold than the exposure.
ID and LED	If the LED check box is activated, the camera will show the set up ID. This is useful during setup. For show use, you might not want to see the ID. If you untick the check box, the ID itself stays unchanged for later use You may setup a maximum ID of 99.
IR Lights	The cameras are equipped with infrared LEDs themselves as they can be used in tracking scenarios with passive (i.e. reflecting) markers. As the coolux tag is an active marker, you won't need to illuminate it. However during setup (with an activated "IR Filter") it might be useful from time to time to illuminate the scene. A value of 0 turns the LEDs completely off whilst 15 results in the maximum brightness.

Mask	<p>With an activated mask, certain areas of the camera's image are blocked. A mask can be set up from the user interface itself (see "Block Visible") or prepared with another image software (see "Load Mask" and "Save Frame")</p> <p>This way you can eliminate areas with reflections or other light noise from the tracking calculation.</p> <p>You may see a mask overlay in the preview mode "Grayscale" and "Segment", not in "Tracking".</p>
Show Crosshair	
Block Visible	<p>This option works only in the camera mode "Segment". It creates a mask. All visible pixels seen in the segment preview are used for the mask and are blocked in consequence. For instance, turn off all tags so that you are sure to block only external light and then press the button. Tick the "Mask" check box to see the blocked pixels as a blue overlay.</p>
Clear Mask	<p>This option clears a mask if you have used the "Block Visible" or "Load Mask" before. If you do not need a mask anymore it is recommended to clear it as well as deactivate it.</p>
Load Mask...	<p>Click this button if you wish to load a mask that you have prepared with a third-party image software. All black areas in the mask, hide the according pixels in the camera's image whilst visible pixels let them pass through. It does not matter whether you use white pixels, or any color, as long as it is not pure black.</p> <p>Supported file formats are: bmp, png, jpg, gif</p>
Save Frame...	<p>This option saves the current frame of the selected camera that is seen in the preview. It is possible to save a frame from the Camera modes: Grayscale, Segment and Tracking. If you have ticked the "Mask" check box, the mask will not be shown as black pixels. Saving a frame is useful when you like to prepare a mask or if you like to document light ratio, e.g. how much light there was during rehearsals.</p>
Highprecision Filtering	<p>This option is needed in order to enable camera pre-filtering of detected segments above threshold, a higher threshold might be chosen for this mode.</p>

### 17.4.5.26.6 Camera Lens Calibration

This topic explains the section "Camera Lens Calibration" of the ID Tag node, for general information about IR ID tracking and links to other chapters please see the topic [ID Tag Tracker<sup>1005</sup>](#).

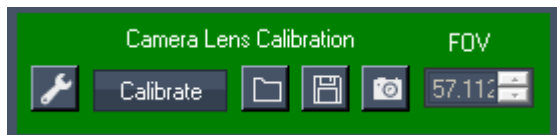

This section includes all settings for calibrating the lens.

Each lens deforms its image in a different way and it increases the accuracy of the tracking if this deformation is compensated. The lens deformation usually needs to be done only once as long as the lens is not removed. For the very best accuracy it is recommended to redo the calibration if the lens focus is altered.

As long as the cameras are not calibrated by you, Widget Designer calls the default calibration files from its installation path:

C:\Program Files (x86)\coolux\Widget Designer 4.5 Rev 708\Data\camera

If the default or your custom calibration files were able to be loaded, the section will be colored green, otherwise red.

For calibrating a lens you need a special image that depicts a checkerboard (details below...). You can either print on a hard board or glue a printed paper to it. Note, that the board needs to be as straight and plane as possible.

Wrench Icon	The button opens the "Camera Calibration Settings" dialog which is described in more detail below... In short, here you set up how the image looks like that you use for the calibration. The image is a checkerboard and is hold in different poses in front of the camera whilst snap shots are saved.
Calibrate	This calibrates the selected camera with the settings taken in the "Camera Calibration Settings" dialog.
Folder / Load Icon	Click the Folder Icon if you have calibrated the selected camera before and wish to load its data from a different path than the default one: C:\Program Files (x86)\coolux\Widget Designer...\Data\camera
Disk / Save Icon	Click this button if you wish to save the calibration data for the selected camera to a different folder than the default one: C:\Program Files (x86)\coolux\Widget Designer...\Data\camera
Camera / Precision Icon	Click this button if you wish to see the result of the Calibration (again).
FOV	This informs you about the field of view of the camera lens. The FOV is calculated during the Calibration and cannot be changed manually.

### Camera Lens Calibration Steps

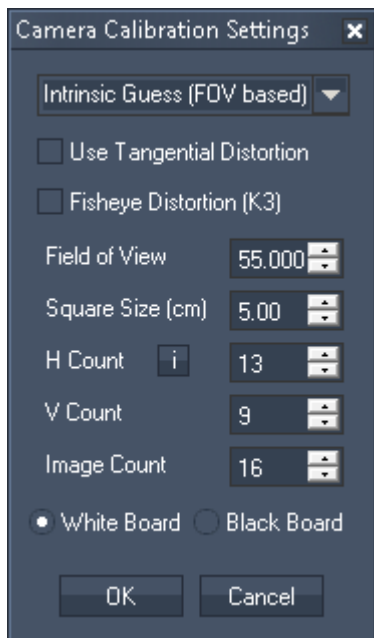

First, click the Wrench Icon to open the left depicted dialog.

The first drop-down and two check-boxes let you choose the calibration method. Afterwards, enter the FOV of the camera lens. Now, all settings relate to the checkerboard:

Square Size: how wide and high is one square, measure in centimeters!  
 H Count and V Count: how many horizontal internal comers are there and how many vertical ones (click the info button for more information)  
 Image Count: how many images will be taken (16 is the recommended minimum)

White / Black Board: is the border around the checkerboard white or black



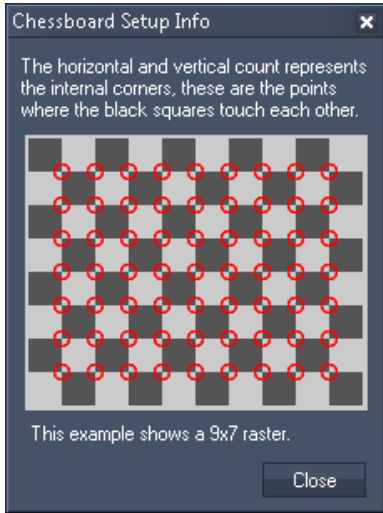

This dialog explains the horizontal and vertical square count.

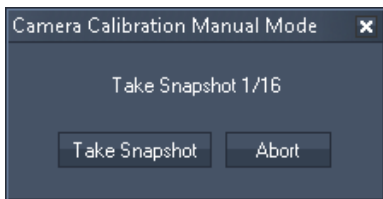

You then hold the checkerboard in front of the camera and take pictures whilst moving either the board or the camera in such a manner that the board covers different parts of the taken image.

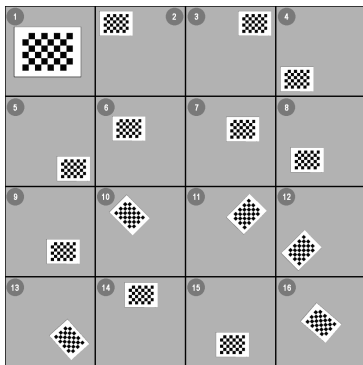

The left image shows recommended calibration poses. Click it, to enlarge the image.

After the last snapshot, a Calibration file is calculated, saved, displayed for your information and afterwards applied to the currently selected camera. To see the Calibration file again, click the Camera / Precision Icon

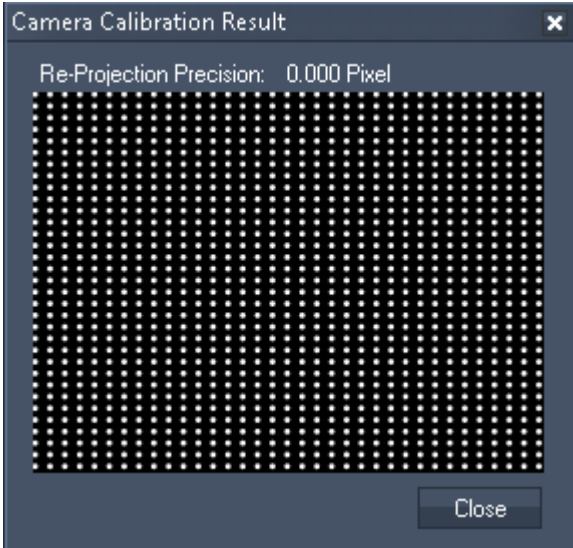

empty Calibration file; after Calibration, the dots are shifted slightly and represent the lens deformation

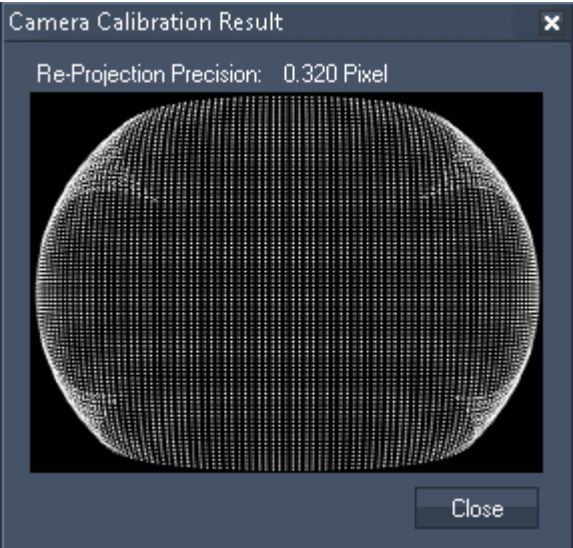

wrong Calibration file, the corners must not be folded inwards

**17.4.5.26.7 Camera XYZ Calibration**

This topic explains the section "Camera XYZ Calibration" of the ID Tag node, for general information about IR ID tracking and links to other chapters please see the topic [ID Tag Tracker](#)<sup>1005</sup>.



This section includes all settings for the setup of the fundamental XYZ World description needed when working with multiple cameras in 3D and 2.5D mode. If you work with one camera only or only in 2D mode, you have the choice to skip this step and work with a [Range filter node](#)<sup>1084</sup> instead.

In general, if one determines a XYZ coordinate, first, an origin of the 3D space is needed, meaning the coordinate system's origin, the orientation of the X-, Y- and Z-axis as well as their scaling. Only when the cameras share the same 3D space information, they can agree on correct XYZ position values for a tag. In other words, only if the origin for each camera can be determined accurately, their reported tag position coincides. If the origin from one camera does not correspond with the one from another camera, they position the tag differently. As long as both cameras see the tag, its final position is averaged but as soon as it is covered for one camera, it can not be averaged anymore and could jump significantly.

The origin calibration also means that the cameras themselves are positioned in the 3D space, this is why this section is called "Camera XYZ Calibration". This can be observed in the 3D mode in the Preview section.

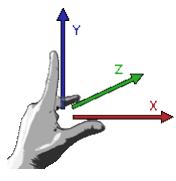

For calibrating the origin for one camera or all of them at the same time, you need to measure and mark a rectangle somewhere on your stage (i.e. four co-planar points). For most applications a 1-2m<sup>2</sup> spot that is seen by all cameras is ok, but this depends on the distance and orientation of the camera(s). For example, if a camera sees a very large area, a 1m<sup>2</sup> spot could be too small to achieve accurate results. Enlarge the rectangle until it covers 1/4 - 1/3 of the camera image seen in the Preview. Ideally it should be positioned in the center of the camera image. For complex applications, you might need to constitute several rectangles for different cameras.

For the sake of simplicity, you could mark four points on the floor. To achieve a better accuracy, the rectangle should include the origin itself, the coordinate 0,0,0. Now, you may decide how the orientation of your 3D space should be. For most scenarios, it makes sense to place the XZ plane onto the ground. A positive X axis means "move right" in Pandoras Box; a positive Z axis "move backwards"; a positive Y axis "move to ceiling". Having these axes in mind measure the XYZ position for each point of the rectangle (in meters!) and copy the data to Widget Designer into the "Origin Settings" dialog as described below. It's a good idea to number the corners 1-4 to remember the order. If you need to work with more than one rectangle, measured these points starting from the 0,0,0 point!

Note: Widget Designer now also offers a "5 Point Calibration Mode". Instead of calibrating the cameras with four points forming a rectangle, you can now also calibrate with five points. This method is of interest when you need to achieve a very precise tracking or if you are not satisfied with your results using a rectangle. In order to make text more readable, the manual will talk about four points or a rectangle, but all information applies comparably to the "5 Point Calibration Mode".

In the next step, the four points belonging to one rectangle will be found in the image of each camera. There are two modes available, an automatic and a manual one. Depending on the camera's position, the rectangle's shape looks different and this is how the camera's position is calculated.

< > buttons	With the help of these buttons you can select the preceding or following camera without using the camera list.
Set Origin XYZ	This button calibrates the selected camera based on the settings in the origin dialog (and the current camera image).
Wrench icon	This opens the below described dialog for the origin settings for the selected camera. For most applications, you calibrate the cameras using one rectangle. Choose "All Cameras" and click the wrench icon. Only if different rectangles are used for different cameras, select the specific camera in the camera list and enter its rectangle corners.
XYZ	This informs you about the calibrated XYZ position in meters for each camera and helps you to determine whether the calculation ran without errors. It is a good workflow to (roughly) measure the camera positions from the origin and compare these figures with the WD values for the assumed position. If the calculation is wrong, the WD position does not correspondent with the real one. If this is the case you can simply click on the "Set Origin XYZ" button again to run the calculation again and achieve a better result. If no result satisfies you, check the origin settings, the camera, the tags and network.

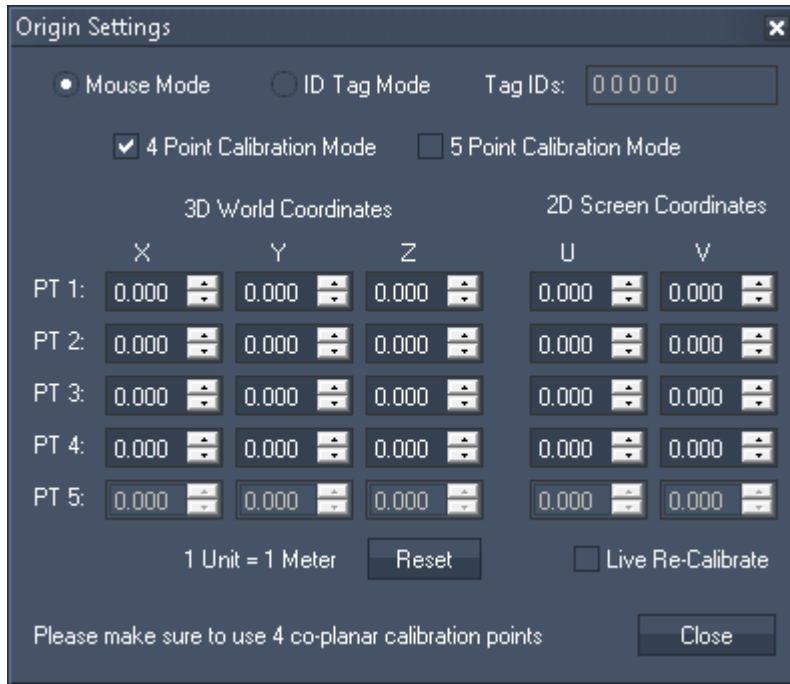

As said above, there are two modes available to find the four points of the drawn rectangle in each image of a camera: the "Mouse Mode" and the "ID Tag Mode" which is easier and faster but requires four different tags.

**ID Tag Mode**

1	Position four tags (holding four different IDs) on the rectangle's points. You might want to cordon off the area so that the cameras keep a free view during the Calibration.
2a	Select "All Cameras" and open the "Origin Settings" dialog. Enter the XYZ location that you measured in the rectangle into the fields of PT1, 2, 3 and 4.
2b	Select "ID Tag Mode".
2c	Enter the corresponding IDs into the text field. Separate the ID numbers with a space, no comma is needed. If you, for example, got tags with ID 11-14 and positioned them onto the rectangle points as follows: 11 on 1, 12 on 2, 13 on 3 and 14 on 4, then you would enter into the text field: 11 12 13 14
2d	Close the dialog.
3a	Select one camera in the Camera List or with the < > buttons.
3b	Adjust the " <a href="#">Camera Settings</a> <sup>1013</sup> " and ... so that you see all four IDs in the <a href="#">Preview</a> <sup>1012</sup> .
3c	Click the "Set Origin" button.
4a	Now, the camera looks for the four IDs, the camera's position is calculated and displayed in the XYZ field.
4b	Check (roughly) whether the calculated position is correct. If you don't like the result, check whether all tags are positioned accurately, check the camera itself (focus etc.), the origin settings, lens settings and the network. You may click "Set Origin" again.
	Start with step 3a for the remaining cameras.

If some cameras do not see the rectangle, a second one needs to be drawn, measured and equipped with ID tags. Redo all above steps, only for step 2a, do not select "All Cameras" but a single one.

**Mouse Mode**

1	You might want to cordon off the rectangle area so that the cameras keep a free view during the Calibration.
2a	Select "All Cameras" and open the "Origin Settings" dialog. Enter the XYZ location that you measured in the rectangle into the fields of PT1, 2, 3 and 4.
2b	Select "Mouse Mode".
2c	Close the dialog.
3a	Select one camera in the Camera List or with the < > buttons.
3b	Adjust the " <a href="#">Camera Settings</a> <sup>1013</sup> " so that you see all four IDs in the <a href="#">Preview</a> <sup>1012</sup> . If you like you can disable the IR Filter, or increase the exposure. If you have at least one tag, you can use it to mark one corner after another. This helps you as the tag's light is seen more clear and brighter .
3c	Click the "Set Origin" button.
4	Now, a crosshair and magnifying glass is shown in the preview section. Click on the spots that mark PT 1, then PT 2... As soon as all 4 points are marked, the camera's position is calculated automatically and displayed in the XYZ field.
4b	Check (roughly) whether the calculated position is correct. If you don't like the result, check whether all marked points are positioned accurately (" <a href="#">Show Marker</a> " <sup>1013</sup> check box, check the camera itself (focus etc.), the origin settings, and the network. You may click "Set Origin" again to mark the points again, for example after adjusting the exposure or light on stage.
	Start with step 3a for the remaining cameras.

**17.4.5.26.8 Marker Settings & Rendering**

This topic explains the section "Marker Settings & Rendering" of the ID Tag node, for general information about IR ID tracking and links to other chapters please see the topic [ID Tag Tracker](#)<sup>1005</sup>.

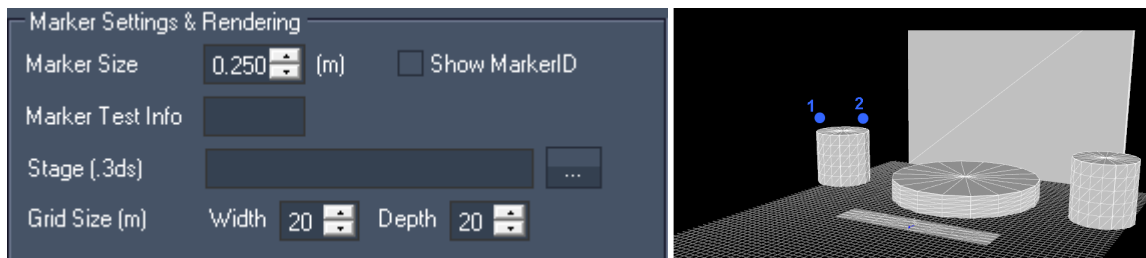

This section includes an information field for markers and further settings for the 3D view in the [Preview](#)<sup>1012</sup>. To toggle this on, choose "3D Tracking" in the section "[Preview Settings](#)"<sup>1013</sup>.

Marker Size	This changes the size of the circle that depicts an ID marker. Per default it is rendered with 25cm.
Show Marker ID	This displays a number on top of the ID marker.
Marker Test Info	This is a helpful tool. Enter an ID marker, e.g. 1 and next to the text field 4 numbers will appear, e.g. 1.2 3.0 0.5 4, meaning that the position of the marker is X=1.2, Y=3.0 and Z=0.5 whilst the camera count that see the tag currently is 4. Using this tool you can control whether the calculated position of a stage marker equals the measured one, verifying that the cameras are well calibrated. Secondly, with the camera count, you can control whether all cameras work. Note that the IDs need to be listed in the table in the section " <a href="#">ID Tag Settings</a> " <sup>1027</sup> .

Stage (.3ds)	Click on the [...] button to load a .3ds file as a 3D model of your stage into the preview. Make sure that it is saved in meter units and with a pivot point on top the <a href="#">XZ plane</a> <sup>1018</sup> .
Grid With/Depth	This changes the amount of the rendered grid lines. One square is always 1m x 1m.

### 17.4.5.26.9 Global Tracking Settings

This topic explains the section "Global Tracking Settings" of the ID Tag node, for general information about IR ID tracking and links to other chapters please see the topic [ID Tag Tracker](#)<sup>1005</sup>.

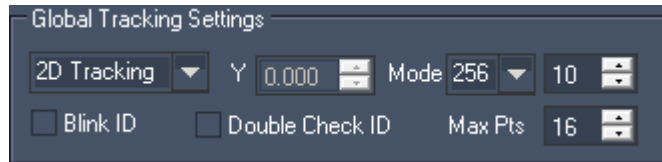

This section includes important settings that influence whether tags are seen and tracked.

	<p>Choose how you like to track the ID tags.</p> <p>"2D Tracking" works only with one active camera (that does not need to be calibrated in XYZ-space). The result for the tag(s) is a position described with X and Y, there is no Z-coordinate! The X- and Y-values depend on the resolution of the used camera, hence their unit is pixel. To scale the values down, for example if you like to follow with a Video Layer, you can use a <a href="#">Range Filter</a><sup>1084</sup> node.</p> <p>2D 2.5D 3D Tracking</p> <p>If you <a href="#">calibrate the XYZ-position</a><sup>1018</sup> of the camera, the output values are in meters and independent from the camera resolution.</p> <p>"2.5D Tracking" works with one or several active cameras. They need to be <a href="#">calibrated in XYZ-space</a><sup>1018</sup>.</p> <p>Y</p> <p>The result for the tag(s) is a position described with X and Z, both represented in meter values and depending on the XZ-movement of the tag. The Y-coordinate does exist, but is independent from the real up-down-movement. Set a constant height with the "Y" number field.</p> <p>"3D Tracking" works with several active cameras. At least three cameras must see a tag at every time. The cameras need to be <a href="#">calibrated in XYZ-space</a><sup>1018</sup>. The result for the tag(s) is a position described with X, Y and Z, all represented in meter values and depending on the real XYZ-movement of the tag.</p>
Mode	<p>The mode (consisting of two figures) must match the "Mode" and "Interval" used when <a href="#">configuring the tags</a><sup>1010</sup>.</p>
Blink ID	<p>This option allows high tracking distances.</p> <p>Per default, the option "Blink ID" is on. As soon as you exceed tracking distances of 10m, this option must be ticked.</p> <p>If you track with lower distances and you have problems detecting a tag ID it might be that the exposure is too high. In that case the off state in the blinking still produces a little bit of light and disturbs the detection.</p> <p>For distances below 1m, reducing the exposure might not be sufficient. In that case, deactivate the "Blink ID" option.</p> <p>An deactivated "Blink ID" option detects the on and off states of the blinking by comparing brighter and darker pixels. This method allows maximum tracking distances of 5m and requires slow movement towards the camera lens.</p>
Double Check ID	<p>This influences the behavior of keeping the tag ID in case of an error. This does not apply for the initial recognition of a tag which is always a double check, i.e. an ID is initialized as soon as it is recognized twice. During and after recognition, tags transfer their ID with</p>

	<p>a blinking pattern. As an exception, it might happen that the pattern is not identified as the same ID as before, it can either be lost or identified as a different ID. This can happen when the tag is not seen by the cameras, e.g. when it disappears behind a set piece or is hidden by another object for a moment.</p> <p>Per default, the option "Double Check ID" is off. In case the ID is stable for a long time and then changes or disappears for a short time, this error weighs comparatively little. The "Off" option allows to soften or damp errors. As long as a blinking light is seen within the diameter set up with "Max Motion" (in <a href="#">"2D Camera Tracking Settings"</a>)<sup>1023</sup> it is assumed that it is the ID it was in the last frames.</p> <p>If "Double Check ID" is ticked, errors are not seen relatively but count absolutely. Even if a tag ID changes or disappears for one moment, this counts. The old ID is removed and deactivated if the error occurred for at least the number of the "Hold" frame count set up in <a href="#">"2D Camera Tracking Settings"</a><sup>1023</sup>.</p> <p>If you activate "Double Check ID" it is very important that the tracking recognition is 100% stable as it is demanded that the ID stays constantly the same.</p>
Max Pts	<p>This option defines how many points are examined to "wear" an ID. The information in the left upper corner of the <a href="#">preview</a><sup>1012</sup> depicts how many "points" a camera sees. This is influenced by the exposure and threshold set up in the section <a href="#">"Camera Settings"</a><sup>1013</sup>. In best case, the point count matches the ID tag count. Realistically, it is a little higher due to disturbing light. The higher "Max Pts" is, the more performance is needed. It is recommended to increase this option only if necessary. If you decrease it to save performance make sure that the real point count does not exceed it.</p>

### 17.4.5.26.10 2D Camera Tracking Settings

This topic explains the section "2D Camera Tracking Settings" of the ID Tag node, for general information about IR ID tracking and links to other chapters please see the topic [ID Tag Tracker](#)<sup>1005</sup>.

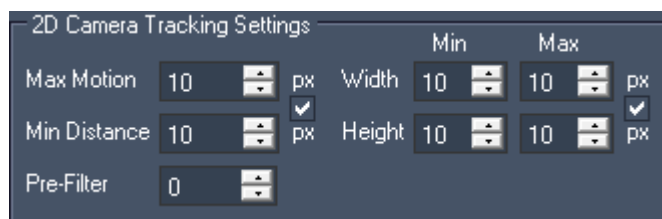

This section includes settings that influence when a tag is recognized as an ID and when the ID is blocked. Before changing these options, make sure that you see the tag's light in the [preview](#)<sup>1012</sup> by setting up the ["Camera Settings"](#)<sup>1013</sup> and that the "Mode" in the section ["Global Tracking Settings"](#)<sup>1022</sup> matches the one the [IDs were configured with](#)<sup>1010</sup>.

Max Motion	<p>This defines the maximum distance an ID can move from one frame to the next. If it is faster, the ID will be removed from the tag.</p> <p>The value is depicted as an outer red circle in the <a href="#">preview</a><sup>1012</sup>.</p> <p>The higher the value is, the more performance is needed. See also the below description of "Min Distance".</p>
Min Distance	<p>This defines the minimum distance two IDs can be next to each other. If they get closer, their IDs will be removed.</p> <p>The value is depicted as an inner red circle in the <a href="#">preview</a><sup>1012</sup>.</p> <p>The smaller the value is, the less stable the ID detection might become as it is more likely that the two blinking patterns or physical tags overlap each other.</p> <p>For a scenario where several tags are attached to one object (e.g. on a panel) it is likely that they are quite close to each other (from the view of a camera or a certain rotation angle). The minimum distance should be set up in such a way that the tags do not</p>

	disappear when rotating and moving the object. At the same time the max. motion should not be larger than the min. distance as this could allow that an ID "jumps" over to another tag in case of a short fault detection. This is why the two parameters are linked to each other.
Min /Max Height Width	This defines how small or big a tag can be seen from a camera before its ID is blocked.
Pre-Filter	This can be called a pre-damping as it defines the number of passed frames from which the position of a processed 2D point is averaged.

### 17.4.5.26.11 3D Tracking Settings

This topic explains the section "3D Tracking Settings" of the ID Tag node, for general information about IR ID tracking and links to other chapters please see the topic [ID Tag Tracker](#)<sup>1005</sup>.

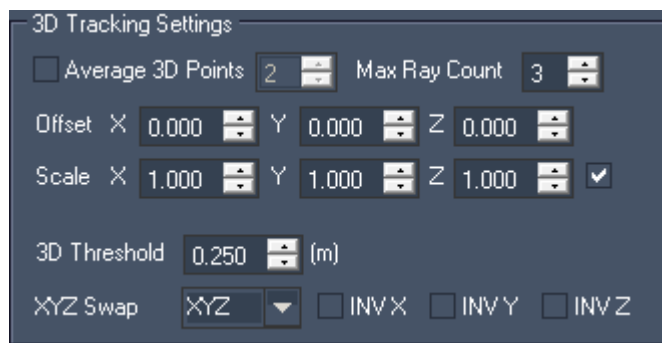

This section includes settings when the 3D Tracking Mode is used (see section ["Global Tracking Settings"](#)<sup>1022</sup>).

Average 3D Points	Enable the "Average 3D Points" option if you have set up several ID tags with the same ID and like to average their position. With the number field you define how many tags with the same ID should be taken into account.
Max Ray Count	This defines how many cameras are taken to determine the 3D position of a tag. The higher the value is, the more performance is needed.
Offset XYZ	With the offset options you can shift the origin of the 3D space, and thus all positions of the tags, without the need of re-calibrating all cameras. <a href="#">Read more...</a> <sup>1018</sup>
Scale XYZ	With the scale options you can increase or decrease the scaling of the coordinate-system of the 3D space, and thus all positions of the tags, without the need of re-calibrating all cameras. <a href="#">Read more...</a> <sup>1018</sup>
3D Threshold	The better the cameras are calibrated and the better the tag light detection and environment is, the more the position from a tag for one cameras consents to the position for another camera. Realistically, the tag's position is a little bit different for each camera. If the estimated position from one camera is further away then the "3D threshold", which is 25cm per default, then this camera is not taken into account and the next available one is taken.
XYZ Swap and Invert	With the swap and invert options you can rotate the X-, Y- and Z axes of the 3D space to change its orientation, and thus all positions of the tags, without the need of re-calibrating all cameras. <a href="#">Read more...</a> <sup>1018</sup>



### 17.4.5.26.12 Performance Options

This topic explains the section "Performance Options" of the ID Tag node, for general information about IR ID tracking and links to other chapters please see the topic [ID Tag Tracker](#)<sup>1005</sup>.

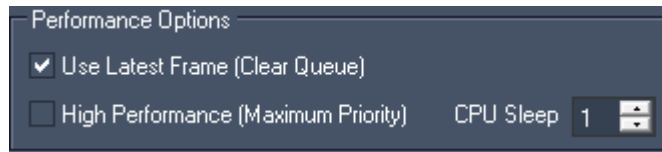

This section includes settings influencing the performance of the tracking calculation.

Use Latest Frame	The default option is to always use the latest frame transmitted from the cameras for the next processing interval. If the option is deactivated, the process waits for all cameras to send a newer frame.
High Performance Mode	This increases the prioritization of the thread for the operating system and allows ultimate CPU usage. Per default the prioritization is set to a normal level.
CPU Sleep	This is the time in milliseconds that is waited before the next frame from the cameras is read and processed.

### 17.4.5.26.13 Motion Prediction

This topic explains the section "Motion Prediction" of the ID Tag node, for general information about IR ID tracking and links to other chapters please see the topic [ID Tag Tracker](#)<sup>1005</sup>.

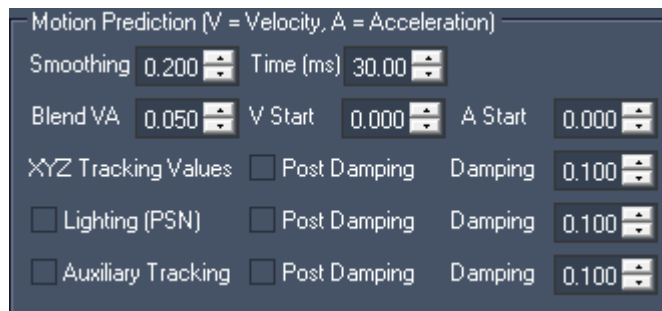

This section includes settings for smoothing, predicting and damping a tag's position. For predicting where the tag will be in the next frame, a complex formula is needed. Depending on the specific movement of your tag, some factors need to be adjusted. A fast movement without abrupt stops is very different to a slow continuous one.

The factors include adjustments for velocity and acceleration. However, the most important settings are "Smoothing", "Time" and "Damping". For most tracking scenarios, the Velocity and Acceleration settings can stay on there default values.

Smoothing	The prediction calculation includes an internal velocity and acceleration part. The "Smoothing" value smoothes this data. It can be understood as a multiplying factor. The smaller Smoothing is, the more the data is damped and modified to reduce noise. Recommended values of 0.1 - 0.2 result in a lot of smoothing as commonly there is much data noise that needs to be reduced. The higher it is, the more the VA-part influences the prediction calculation. A factor of 1 means no data modification, no smoothing.
Time (ms)	"Time" should be adjusted to meet the real duration that exists between measuring the tag's position and seeing or hearing the result, e.g. projecting an image onto this position. This delay is measured in milliseconds. Delay times up to 80-120ms are common.

<p>Blend VA V Start A Start</p>	<p>The velocity and acceleration part contribute to the calculation as soon as a "Start" value is met. In other words, if the velocity (and acceleration respectively) is below that start value, the VA-part is not taken into account. Velocity is measured in mm/sec and Acceleration in mm/sec<sup>2</sup>. If your tag jitters slightly eventhough the tag does not move at all, you can raise the VA Start to 0.3 mm for instance to discard the VA-prediction for these small movements Blend VA blends between these two formulas with and without the VA-part.</p>
<p>Lighting and Aux. Tracking</p>	<p>This applies when you have a node attached to the ID Tag Tracker node. Per default you see in the node's input drop-down list, that every tag is expressed with a position (X, Y, Z). In case you have more than one device following the tracking it might be needed to add different damping times to the XYZ-position to route them to different output nodes. When enabling "Lighting (PSN)" you will see that each tag has an additional X2, Y2 and Z2 value; when enabling "Auxiliary Tracking" X3, Y3 and Z3 are available. As soon as you add different damping times (see below) to these values, they will not coincide any more. Please note that the two check boxes are not of interest when outputting PSN data directly from the node!</p>
<p>Post Damping</p>	<p>This activates an additional damping calculation. "Damping" is similar to the "Smoothing" as it smoothes the data. But as "Damping" happens at the very end of the calculation, after prediction, it can be understood as a post damping that smoothes the predicted curve to reduce jittering. "Post Damping" can be applied to three data sets introduced above. You can setup different damping times to...: - "XYZ Tracking Values" = X1 Y1 Z1 (default values of the node) - "Lighting (PSN)" = <a href="#">PSN output</a><sup>1026</sup> send out directly from the node as well as X2 Y2 Z2 if the left check box is ticked - "Auxiliary Tracking" = X3 Y3 Z3 if the left check box is ticked You can set up damping times to adjust the tracking behavior for different devices. A factor of 1 means no data modification, no damping whilst values between 0 and 0.1 mean a lot damping.</p>

### 17.4.5.26.14 MA PSN Output

This topic explains the section "MA PSN Output" of the ID Tag node, for general information about IR ID tracking and links to other chapters please see the topic [ID Tag Tracker](#)<sup>1005</sup>.



This section includes settings for the PSN data output. The PosiStageNet protocol is for example supported by MA Lighting consoles; more information can be found on [www.posistage.net](http://www.posistage.net).

In general PSN needs to be activated in the [Connection Manager](#)<sup>1169</sup> where you can also find other settings like the IP and port for the PSN MA Tracking Server.

<p>Enable</p>	<p>This outputs the X-,Y- Z-coordinate of each tag.</p>
<p>Inv XYZ and Swap</p>	<p>The coordinate system on which the tag positioning is based can be set up in two steps. First is when calibrating the cameras, second is in the section "3D Tracking Settings". Both influence the values for a tag in Widget Designer. However, if the lighting system uses a different coordinate system, you can change the position for the tags only for the PSN output without the need to adjust Widget Designer or Pandoras Box.</p>

You may invert the orientation of each axis, or even change the XYZ order into a YXZ one, for example.

### 17.4.5.26.15 ID Tag Settings

This topic explains the section "ID Tag Settings" of the ID Tag node, for general information about IR ID tracking and links to other chapters please see the topic [ID Tag Tracker](#)<sup>1005</sup>.

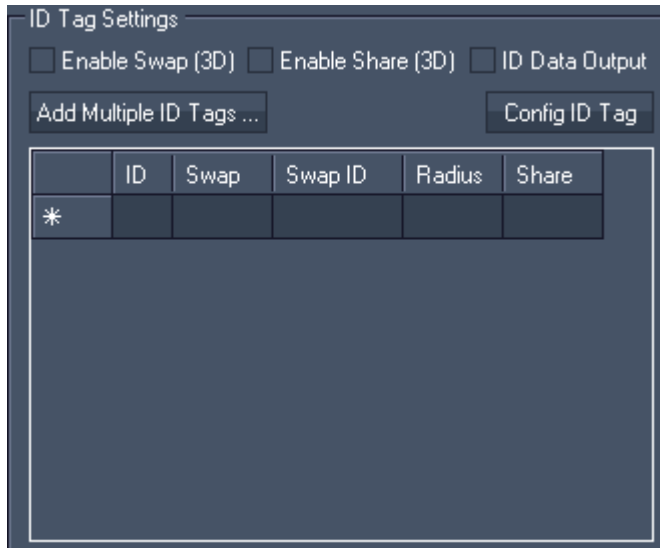

This section includes tag settings, most of them apply when the 3D Tracking Mode is used (see section ["Global Tracking Settings"](#)<sup>1022</sup>).

If you like to use data of a tag as an output value of the ID Tag Tracker node or if you like to see the tag in the [preview](#)<sup>1012</sup>, the tag needs to be listed in the table. To add a tag, click into the row and enter its ID or use the "Add Multiple Tags" button. If you need to change an entry, simply (right-)click into the cell. To delete a tag ID, you need to delete the entire row. To do so, click into the first cell (\*) to select the row and press the "Delete" key on your keyboard.

To see the data from the node activate "ID Data Output".

Enable Swap	This enables the "Swap" function. After enabling "Swap", two listed tags need to wear a "Swap ID". Then, a "Radius" needs to be set up. Now, as soon as two tags meet each, meaning that there are as close as the "Radius" says, they will exchange their "Swap ID".
Enable Share	This enables the "Share" function. After enabling "Share", at least two listed tags need to wear a "Share ID". Then, a "Radius" needs to be set up. Now, as soon as two tags meet each, meaning that there are as close as the "Radius" says, one tag will overwrite the "Share ID" of the other one.
ID Data Output	This enables the data output meaning that the ID Tag Tracker node outputs data that can be used in other nodes.
Add Multiple Tags	This opens a dialog that fastens the process of entering multiple tags to the list that is described above.
Config ID Tag	Please see the chapter <a href="#">"Config ID Tag"</a> <sup>1010</sup> .

### 17.4.5.26.16 Lighting Console Settings

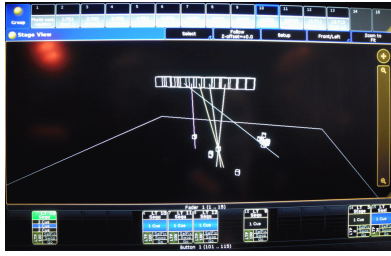

This topic explains how to setup tracking with lights, e.g. a moving light (or follow spot) follows the position of a person wearing a tag. The goal is to give you a short to do list with settings for Widget Designer and for the lighting console. For general information about IR ID tracking and links to other chapters please see the topic [ID Tag Tracker](#)<sup>1005</sup>.

As an exemplary console the GrandMA 2 was chosen. Other consoles supporting PSN work also but their settings might differ.

### Requirements

#### Network connection between console and Widget Designer PC

Widget Designer and the lighting console are connected via network and both are setup with a static IP address. You can use any IP range but if you additionally like to send Art-Net data you should use a 2.x.x.x IP address and 255.255.255.0 as subnet mask. Make sure that this connection works by pinging the console from the WD PC! When using the onPC-version, double-check also that your anti-virus software and Firewall are not blocking incoming data.

#### Same origin

The 3D world setup in WD for the tracking and the 3D space setup in the console for the (moving) lights should be based on the same origin position, i.e. 0,0,0 point and scaling. It is possible to offset and rescale data, but it makes life much easier to work with the same reference point from the beginning. You may choose to use different orientations (rotation of axes) but you must then [swap or invert the axes](#)<sup>1026</sup> for the PSN data. Most likely you need to choose XZY.

#### Lights position and orientation are measured and the light fixtures are setup accordingly

Based on the mentioned origin, the moving lights' position and orientation needs to be measured and in Stage View all light fixtures need to be placed according to these figures.

1st tip: Level the moving lights (e.g. with a water level). 0.5° rotation can have a huge impact on the position of the follow spot and it is far easier to level a device than measure its exact rotation.

2nd tip: Using a laser distometer saves time especially for many lights and large distances. There are 3D laser tools available. coolux offers a tool for the [3D Disto from Leica](#)<sup>831</sup>.

Before mounting the lights it makes sense to mark the point whereto you like to measure e.g with tape. Check whether the console knows your light and the distance (offset) between the pivot in the yoke and the lens. Measure then the distance between your own marker and the lens and add / subtract this when entering the height for the light

3rd tip: Mark 4-8 positions on your stage, measure them and tell the lights to go to this point.

Depending on a light's offset to these various stage positions, you can modify its position and orientation until it is accurate enough.

4th tip: Check whether the movement of the lights in Stage View accords with the real movement, if not swap the Pan / Tilt parameter. For doing so, you might need to deactivate "XYZ Positioning" in "Fixture Types" temporarily.

#### - Tracking in WD is setup

All cameras are calibrated and when a tag moves around, it does the same in the preview without disappearing and jittering. Mark 4-8 positions on your stage, measure them and place a tag onto them. Check whether the value from the ID Tag Tracker node coincides with your measurement.

## Settings to control a Moving Light / Stage Marker with a tag

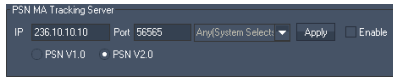

In WD...

- Connection Manager > [Enable PSN](#)<sup>1169</sup> protocol (do not change the IP from the PSN Server)
- ID Tag Tracker node > [Enable PSN](#)<sup>1026</sup> data
- ID Tag Tracker node > [ID Tag Settings](#)<sup>1027</sup> > add all tag IDs you want to use



In the lighting console...

- Setup > Network > PSN Network Configuration > Enabled => button is highlighted in yellow
- Add > Tracking System
  - the column "Enabled" should say "Yes"
  - the column "IP" should display the IP address from the WD PC
  - the columns "Multicast" and "Port" should coincide with the (default) settings found in the WD Connection Manager



- as explained above, your patch should already include the light-fixtures; check in "Fixture Types" that "XYZ Positioning" is turn on
- add a MA-Stage Marker-fixture to the patch, that is one fixture per ID tag



- Setup > Network > PSN Network Configuration > View Tracker => displays a list of all PSN IDs, their Fixture ID and incoming XYZ-position
- assign a fixture to each PSN ID (i.e. tag ID)

- the below images depict 14 moving light fixtures hanging site by site in a truss whilst 2 stage markers (IR tags) lay on stage
- as the last step, select a fixture and go to "Position" to attach a marker to it

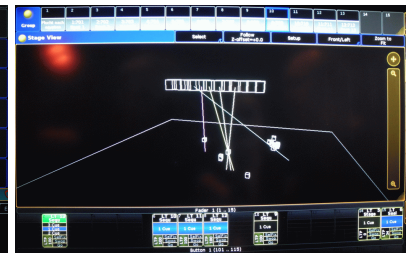

### 17.4.5.27 IPHONE REMOTE

The iPhone Remote input node allows receiving the current iPhone remote single and multi-touch values. Set up your iPhone Remote Control in the [Remoting Tool](#)<sup>1182</sup>.

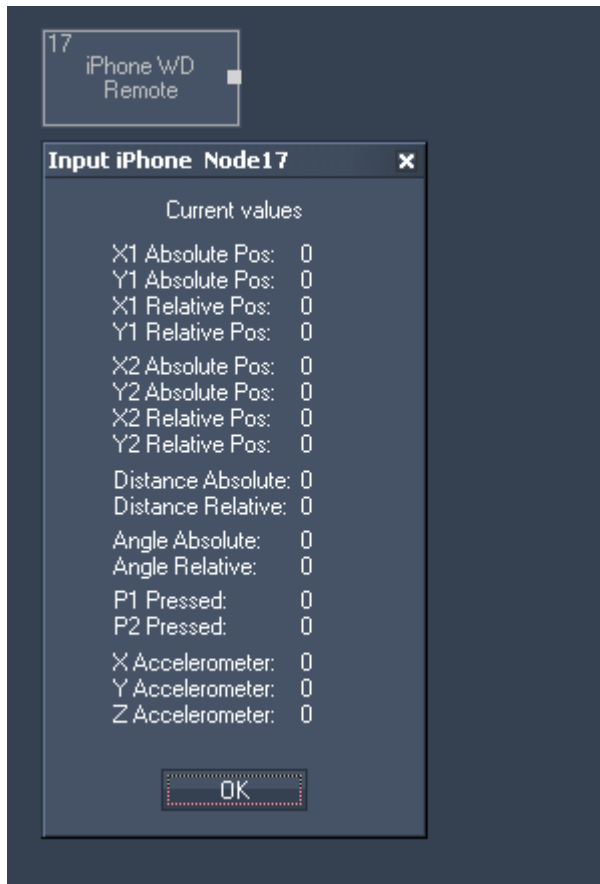

The Node generates the following output:

- Absolute and Relative Positions of two points (X1/Y1 and X1/X2),
- Distance and Angle Absolute / Relative,
- P1 or P2 pressed (True=1 and False=0),
- X,Y and Z Accelerometer.

### 17.4.5.28 JOYSTICK

The Joystick input node allows intercepting standard Windows gaming device input values for axis slider and button input.

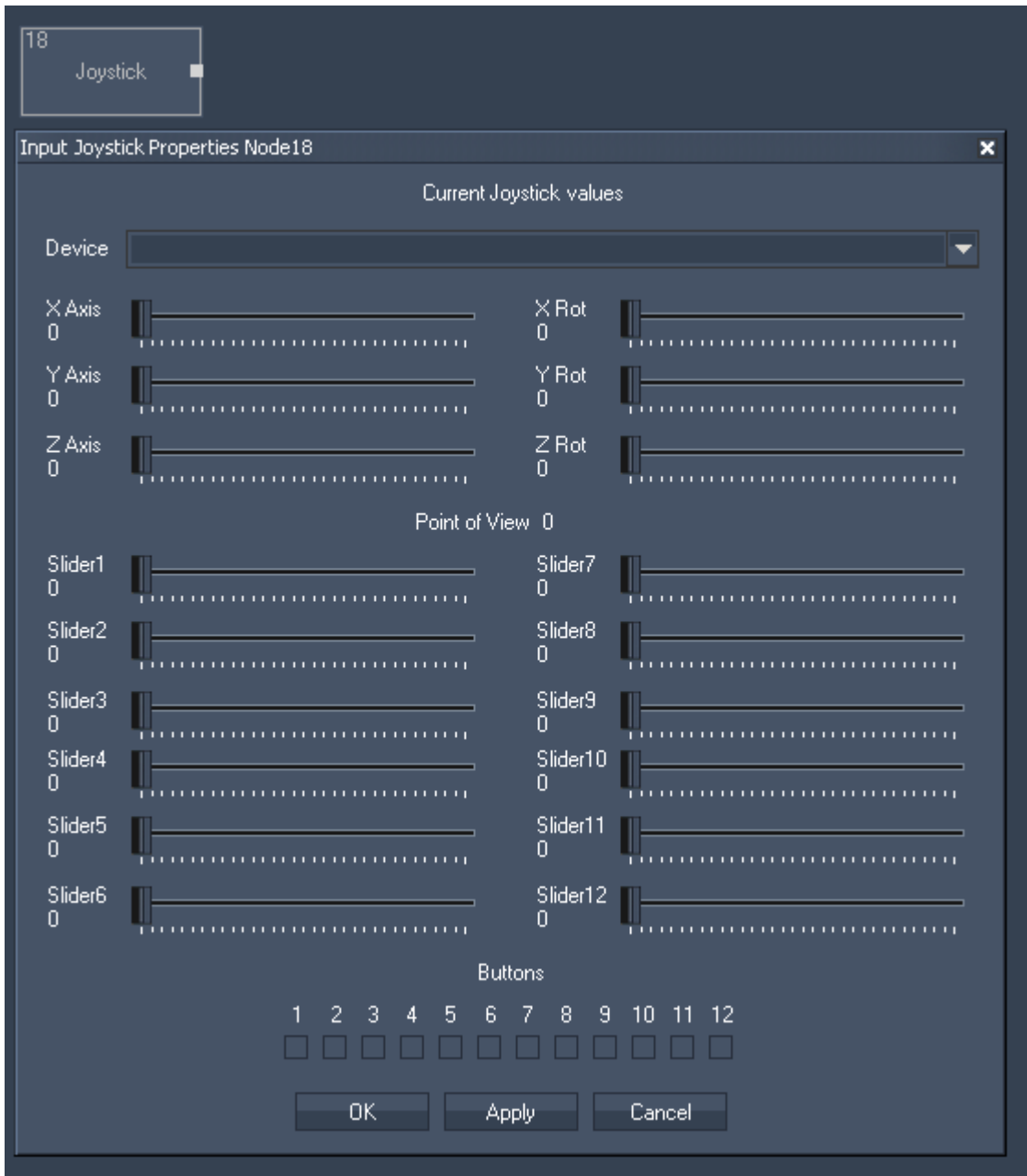

Node Properties:

Device:

Choose your gaming device from the list.

The Node generates the following output:

- X Axis,
- Y Axis,
- Z Axis,
- X Rot Axis,
- Y Rot Axis,
- Z Rot Axis,
- Point of View

- Slider 1 to 12
- Button 1 to 12

### 17.4.5.29 KINECT

The Kinect input node allows capturing up to 8 filtered and tracked points/regions of interest via the Kinect device. Setup your device in the [Kinect Tool](#)<sup>1162</sup> first.

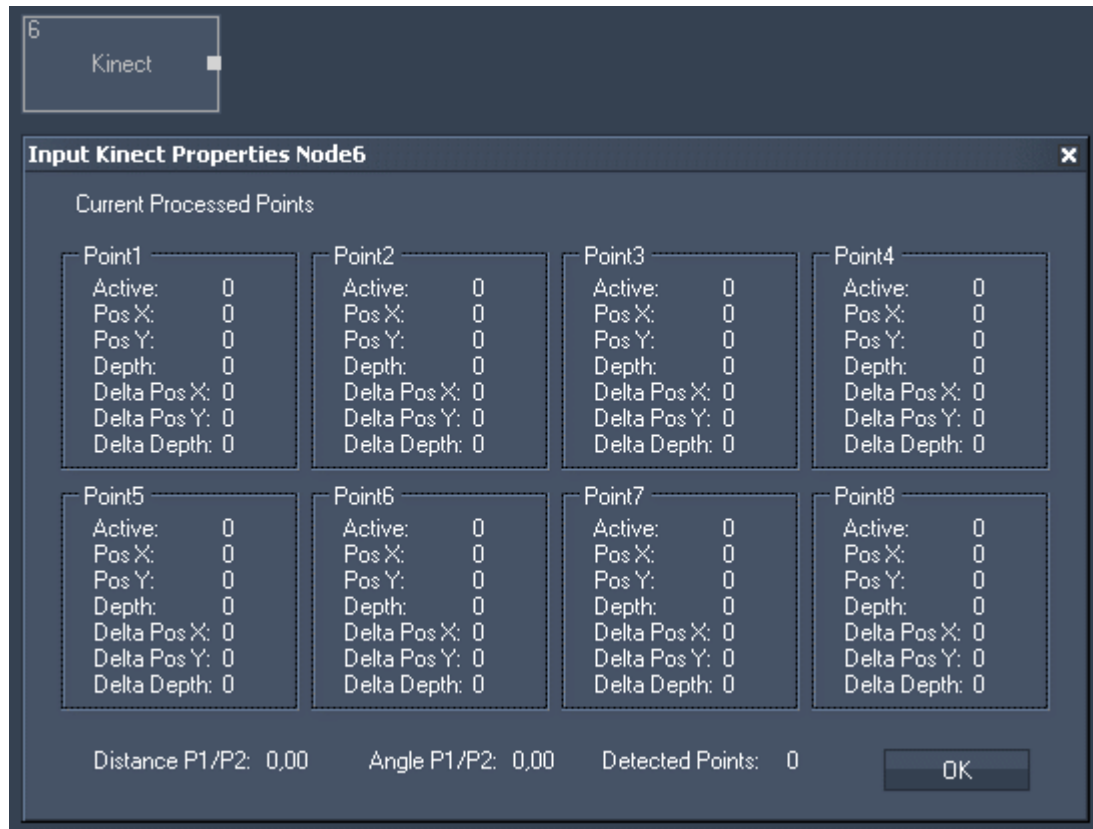

Node Properties:

The Node generates the following output for each of the 8 points:

- Active,
- Pos X,
- Pos Y,
- Depth,
- Delta Pos X,
- Delta Pos Y,
- Delta Depth.

It outputs the overall active point count as well:

- Point Count.

### 17.4.5.30 KINESYS

The Kinesys K2 Input Node allows you to grab X,Y,Z, Pitch, Tilt & Roll data from a Kinesys K2. Please note, that a Multicast UDP Client on Port 6061 is required. Set it up in the [Connection Manager](#)

<sup>1166</sup>



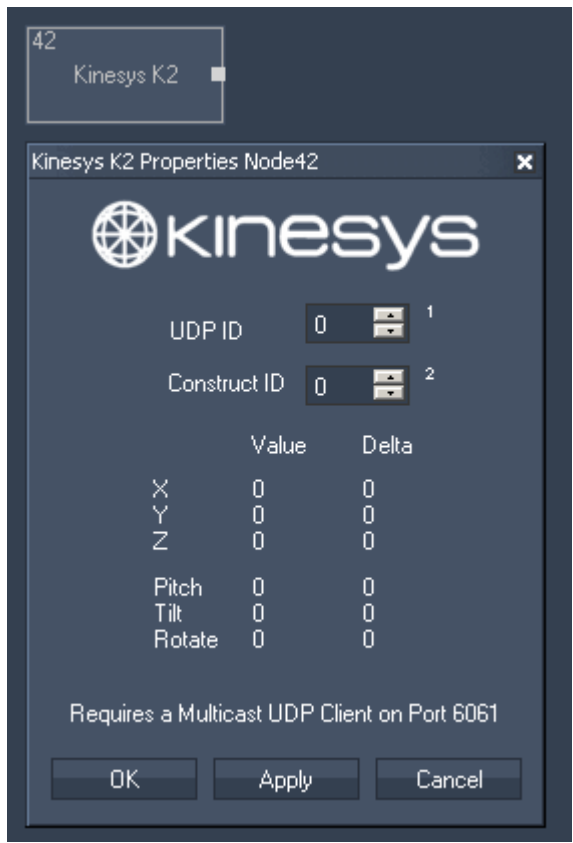

Node Properties:

UDP ID:

Choose the ID of your UDP Multicast Connection (see [Connection Manager<sup>1166</sup>](#)).

Construct ID:

Choose the ID of the Construct as it is named in your Kinesys K2.

The Node generates the following output:

- Kinesys K2 X,
- Kinesys K2 X Delta,
- Kinesys K2 Y,
- Kinesys K2 Y Delta,
- Kinesys K2 Z,
- Kinesys K2 Z Delta,
- Kinesys K2 Pitch,
- Kinesys K2 Pitch Delta,
- Kinesys K2 Tilt,
- Kinesys K2 Tilt Delta,
- Kinesys K2 Rotate,
- Kinesys K2 Rotate Delta.

### 17.4.5.31 LABEL

The Label input node allows using label texts for further processing.

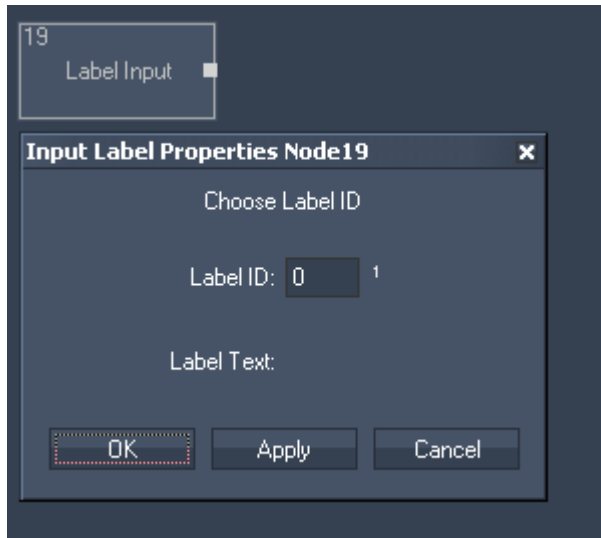

Node Properties:

ID:

Enter the Label ID in the text field.

The Node generates the following output:

- Label Input Value (as String).

### 17.4.5.32 MEDIA CONTROL

The Media Control input node allows to intercept the last called Folder and File ID of one or multiple Media Control Panels.

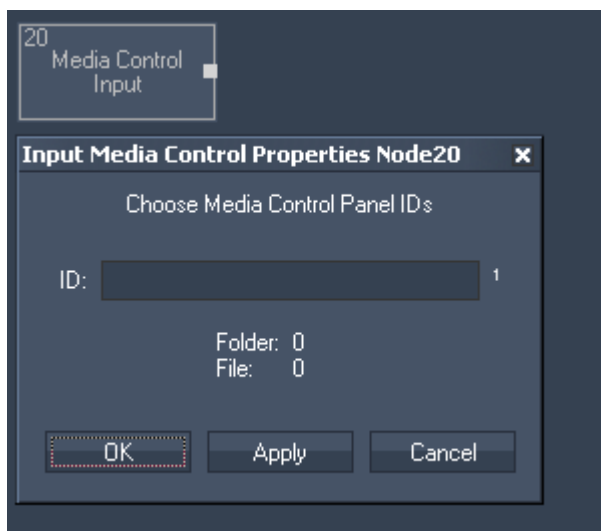

Node Properties:

ID:

Enter the Media Control Panel ID in the text field.

The Node generates the following output:

- Media Control Input Folder ID and
- Media Control Input File ID of the last called File.

### 17.4.5.33 MIDI IN

The Midi input node allows receiving 7bit or 15bit input values as well as Note On/Off and raw byte messages.

The Midi connection needs to be enabled in the [Connection Manager](#)<sup>1166</sup>.

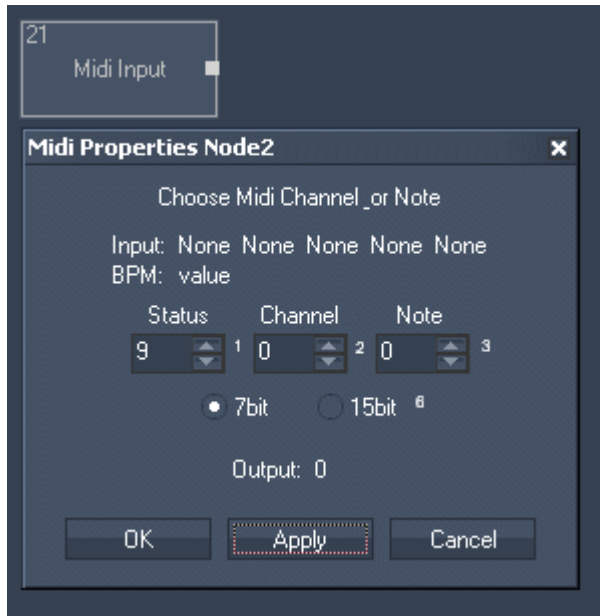

Node Properties:

Enter the Status, Channel and Note value. Choose between 7bit or 15bit input values.

The Node generates the following output:

- Midi Input Current Value
- Midi Input Trigger
- Midi Input Status Byte
- Midi Input Channel Byte
- Midi Input DataByte 1 to DataByte 3 and
- Midi Input BPM.

### 17.4.5.34 MIDI NOTE CATCH

The node catches and outputs the first incoming Midi Note Message.

This is in particular useful for game scenarios where WD needs to identify the first incoming Midi Note event.

This node can be reset by setting Parameter 1 to 0 via the command "[WDNodeSetParam](#)<sup>1363</sup>".

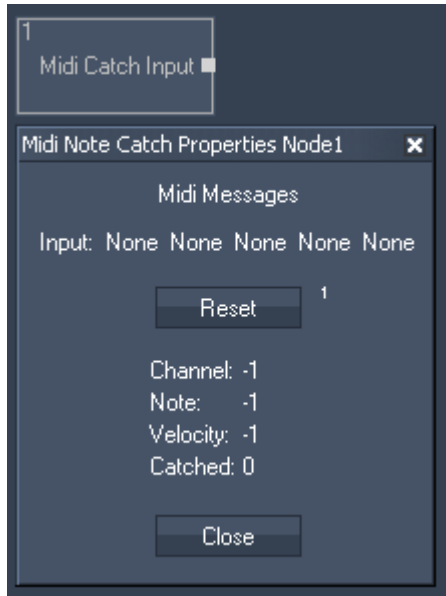

The Node generates the following output:

- Midi Catch Input Channel,
- Midi Catch Input Note,
- Midi Catch Input Velocity,
- Midi Catch Input isCaught.

### 17.4.5.35 MOTION DETECTOR

The Motion Detection input node provides the data given by the [Motion Detector Tool](#)<sup>1223</sup> for further processing.

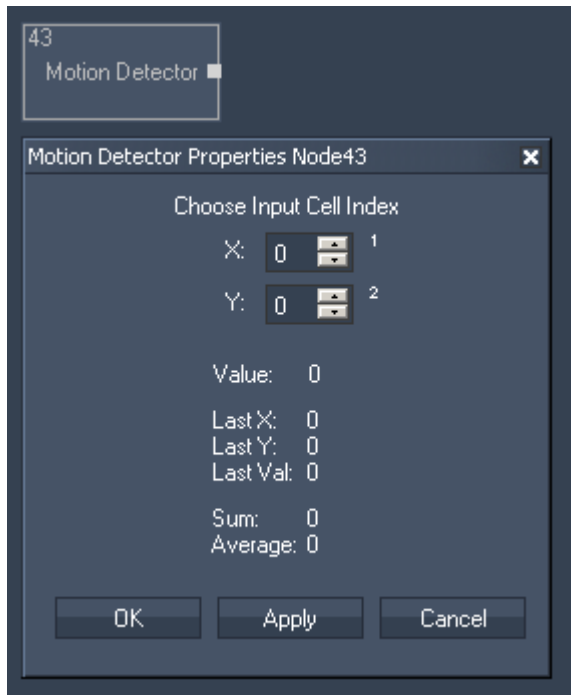

Node Properties:

XY:

Choose here the Input Cell Index from the Motion Detector Tool whose data you want to use by entering the column number (X) and the row number (Y).

The Node generates the following output:

- Motion Detector Value (the value of the chosen cell)
- Motion Detector Last X (X index of the cell in which the last motion was detected)
- Motion Detector Last Y (Y index of the cell in which the last motion was detected)
- Motion Detector Last Value
- Motion Detector Sum (Sum of all cell values)
- Motion Detector Average (Average of all cell values).

### 17.4.5.36 MOUSE

The Mouse input node provides the Mouse X&Y position as well as the three button press states Left, Middle and Right.

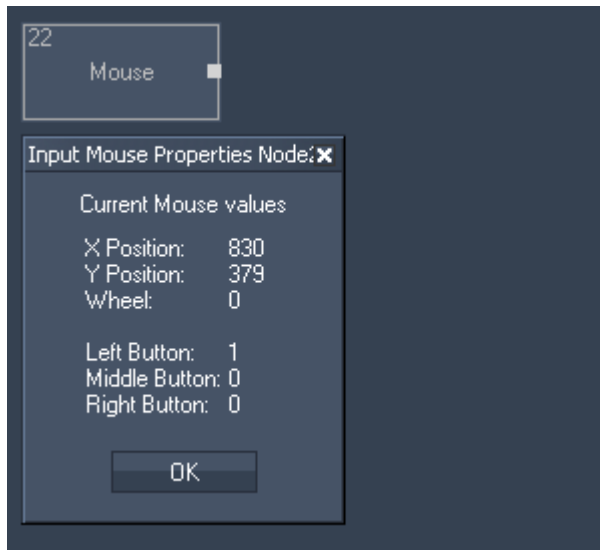

The Node generates the following output:

- Mouse X Pos,
- Mouse Y Pos,
- Mouse Wheel,
- Mouse Left Click,
- Mouse Middle Click,
- Mouse Right Click.

### 17.4.5.37 MULTI-TOUCH ITEM

The Multi-Touch Item input node provides the current state of a Multi-Touch Item (Position, Rotation, Size) as well as the current state of the Layer in PB linked to this Item. See the [Multitouch Tool](#)<sup>936</sup> for further information and setup.

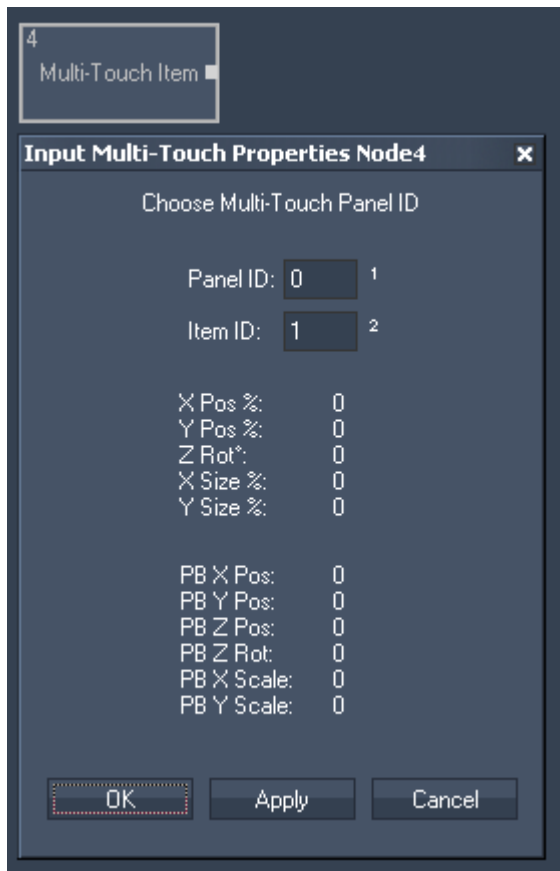

Node Properties:

Panel ID:

Enter the ID of the Multi-Touch Panel.

Item ID:

Enter the ID of the Multi-Touch Item you want to use.

The Node generates the following output:

- Multi-Touch Item X Pos %
- Multi-Touch Item Y Pos %
- Multi-Touch Item Z Rot °
- Multi-Touch Item X Size %
- Multi-Touch Item Y Size %
- Multi-Touch Item X Size %
- Multi-Touch Item X Pos PB
- Multi-Touch Item Y Pos PB
- Multi-Touch Item Z Rot PB
- Multi-Touch Item X Size PB
- Multi-Touch Item Y Size PB
- Multi-Touch Item X Size PB

### 17.4.5.38 MULTI-TOUCH PANEL POINT

The Multi-Touch Panel Point input node provides the current Position of a Point inside a Multi-Touch Panel. See the [Multitouch Tool](#)<sup>936</sup> for further information and setup.

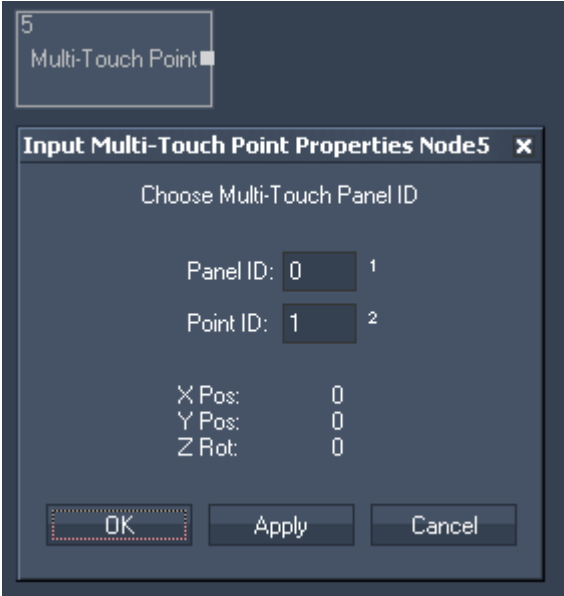

Node Properties:

**Panel ID:**  
Enter the ID of the Multi-Touch Panel.

**Point ID:**  
Enter the ID of the Multi-Touch Point you want to use.

The Node generates the following output:

- Multi-Touch Point X Pos
- Multi-Touch Point Y Pos
- Multi-Touch Point Active

### 17.4.5.39 NET LINK - GENERIC I/O

The NET Link Input node allows to communicate with the Calibration Link or a NET Link equipped with input and / or output boards. Please see more information in the chapter covering the [NET Link](#)<sup>747</sup>. On the one hand the node receives information send from available inputs, hence, it provides this data to other nodes in Widget Designer. On the other hand, it allows to configure the device and send commands to it. In case of output boards, a contact closure can be commanded through this node.

The [Calibration Input node](#)<sup>989</sup>, the [Relay Output node](#)<sup>1126</sup> and the tool "[Projector Calibration Manager](#)<sup>1236</sup>" might also be of interest for you.



Create > Nodes > Input > Devices > NET Link - Generic I/O



## Node properties

### IP and Port

Enter the correct IP address and port from the NET Link's CPU or from the Calibration Link.

### Reset To Factory Default

This buttons resets the above settings in the Widget Designer interface. To reset the device itself (to the IP address 192.168.178.222 and the port to 5000), hold the "Reset" button down whilst plugging the power into the device. Release the button again.

### Connect / Disconnect

Before starting to communicate with the device, for instance receive data, the node must be connected to the device. The connection itself consumes no performance.

### Change IP Address

This button opens a new dialog whereto you may enter another IP address and port for the device. Power-cycle the device to apply the changes.

### Config Module

A NET Link / Calibration Link is configured by coolux as you have ordered it. However, if you have changed some input / output boards, the processor must be configured in terms of giving him the information which boards are connected to it. Click the "Config Module" button to open a new dialog where you may choose the according boards per processor connection. Find more details in the [NET Link hardware chapter](#)<sup>747</sup>.

### Start Data / Stop Data

As soon as data is processed via the network from the device to Widget Designer, performance is drawn.

### Store Last Transmission State to NET Link CPU

Click this button and power-cycle the device if you wish that it remembers whether it should (not) send data as soon as it is powered up.

### Node control

This node allows to be remote controlled via so called [node commands](#)<sup>977</sup>. Node commands access functions from a node and / or set a parameter.

Enter "node", followed by the according ID and a dot and a list will pop up showing all available commands for the node. For instance, `node1.StartData` will execute the function automatically without the need of opening the Item Properties dialog and clicking the according button manually. In addition, the node properties with a parameter ID (the small superscript number) can be edited via the commands `WDNodeSetParam,NodeID,ParamID,Value` or `nodeID.ParamID@Value`.

### Node output values

The node generates the following output:

- A1 to A8 (0 - 1023) for the first analog bus
- B1 to B8 (0 - 1023) for the second analog bus
- D1.1 to D1.128 (Open = 0, Closed = 1) for the first digital bus
- D2.1 to D2.128 (Open = 0, Closed = 1) for the second digital bus
- Connected

### 17.4.5.40 ODSL 30

The ODSL 30 Input node lets you read out distance data from the optical distance measuring sensor ODSL 30 via a local COMPort connection (RS232). The COMPort Connections can be found and setup in the [Connection Manager](#)<sup>1166</sup>.

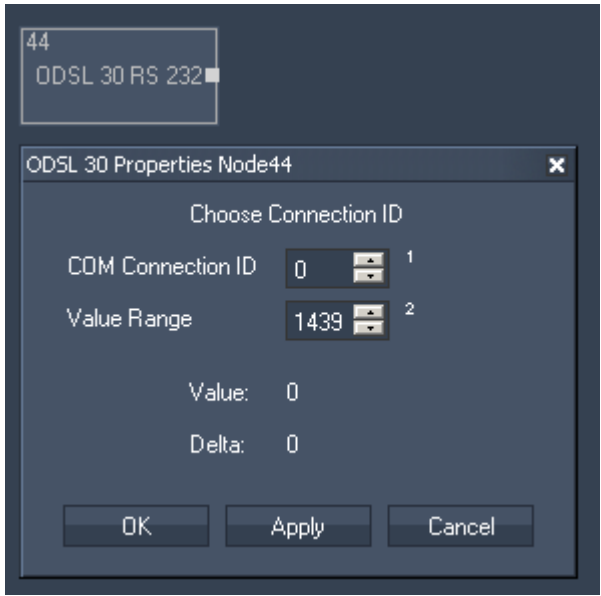

Node Properties:

COM Connection ID:

Choose the COMPort Connection ID to listen to. The COMPort Connections can be found and setup in the [Connection Manager](#)<sup>1166</sup>.

The following settings need to be used:

600/8n1 (Baud Rate: 9600, Parity: None, Data Bits: 8, Stop Bits: 1).

Value Range:

The range defines the jump point of a maximum value back to zero.

Enter the range in mm. This is only important for correct calculation of delta values when using as incremental length count.

The Node generates the following output:

- ODSL 30 RS 232 Value
- ODSL 30 RS 232 Delta

### 17.4.5.41 OSC

The OSC Input node lets you receive data via the Open Sound Control Protocol, e.g. from iPhone, iPad or iPod (tested with Touch OSC).

A UDP Broadcast Input Connection is required, see [Connection Manager](#)<sup>1166</sup>.

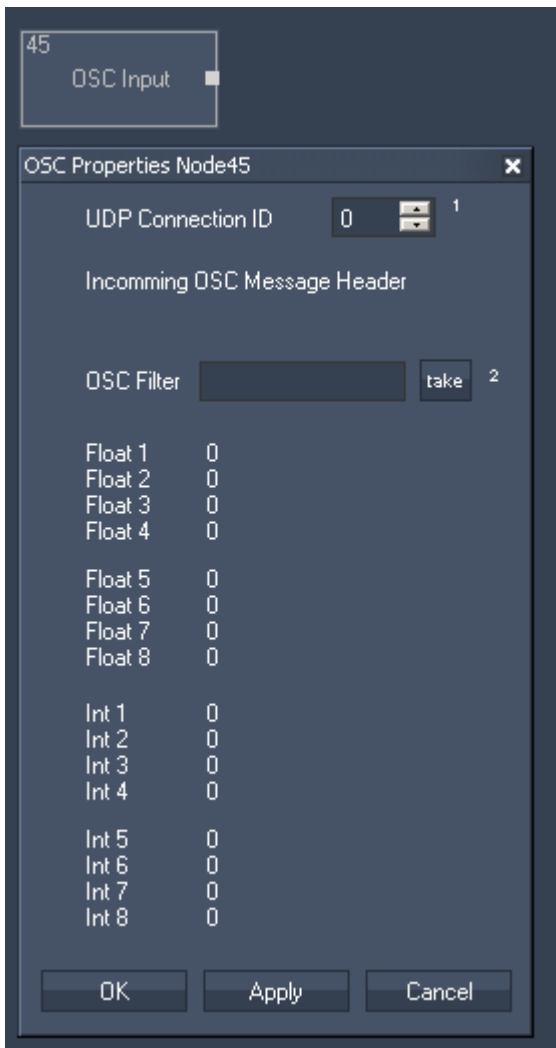

Node Properties:

UDP Connection ID:

Choose the UDP Connection to listen to. The UDP Connections can be found and setup in the [Connection Manager](#)<sup>1166</sup>.

OSC Filter:

If an OSC message is incoming, the OSC Message Header will be displayed. To assign messages with this Header to this OSC Input Node (e.g. send from a fader or button in OSC Touch), press [take]. Float1 to Float8 and Int1 to Int8 will now display the message details.

The Node generates the following output:

- OSC Input Float 1-8
- OSC Input Int 1-8
- OSC Input Msg

### 17.4.5.42 PAGE

The Page input node allows using the current page name for further processing.

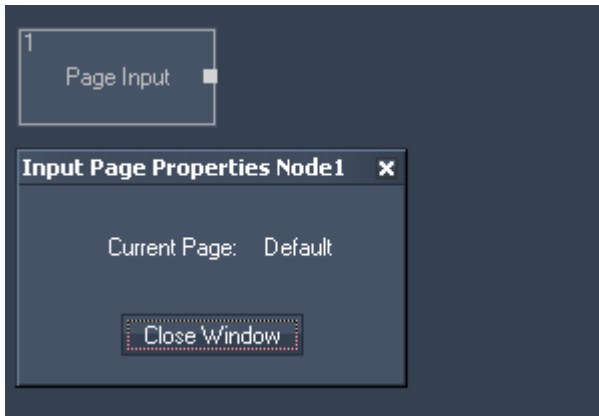

Node Properties:

The Node generates the following output:

- Page input value

### 17.4.5.43 PB DEVICE PARAMETER INPUT

The PB Device Parameter input node provides feedback values for all layer parameters from a Pandoras Box Master and Backup System for further processing.

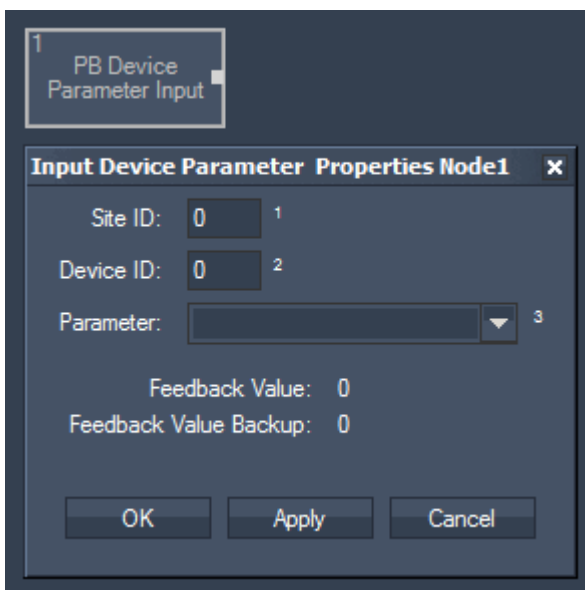

Node Properties:

Site ID:

Enter the Site ID from which you want to get feedback values.

Device ID:

Enter the Device ID from which you want to get feedback values.

Parameter:

Choose the parameter you want to monitor from the list.

The Node generates the following output:  
 - PB Device Parameter Input Value  
 - PB Device Parameter Input Backup Value

Example:

To route the current value of the parameter X Position of layer 1.3 to another node, enter "1" as SiteID, "3" as DeviceID and choose "X Position" from the drop-down list.

The PB Master and Backup Connection needs to be set up in the [IP Configuration](#)<sup>865</sup> first!

### 17.4.5.44 PING

The Ping input node gives you feedback in a certain time interval if the specified IP is online.

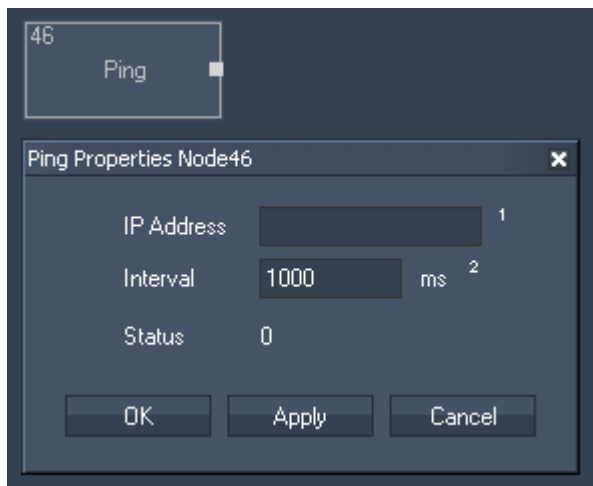

Node Properties:

IP Address:

Enter the IP Address you want to ping.

Interval:

Enter the update interval in milliseconds.

The Node generates the following output:

- Ping status (true or false).

### 17.4.5.45 PROJECTOR CONTROL

The Projector Control Input node allows to communicate with projectors via a TCP connection. The communication includes controlling the projector, e.g. closing the shutter or powering it, as well as receiving feedback information, e.g. regarding the shutter or power status. The node itself has three status "lights" that change color depending on the projector's response. Hence, the node provides a good overview without the need to open its properties or connect the node with other controls like [labels](#)<sup>931</sup>. In order to send a message to a projector you may either press the according button in the node or execute a node command as described below.

Create > Nodes > Input > Devices > Projector Control

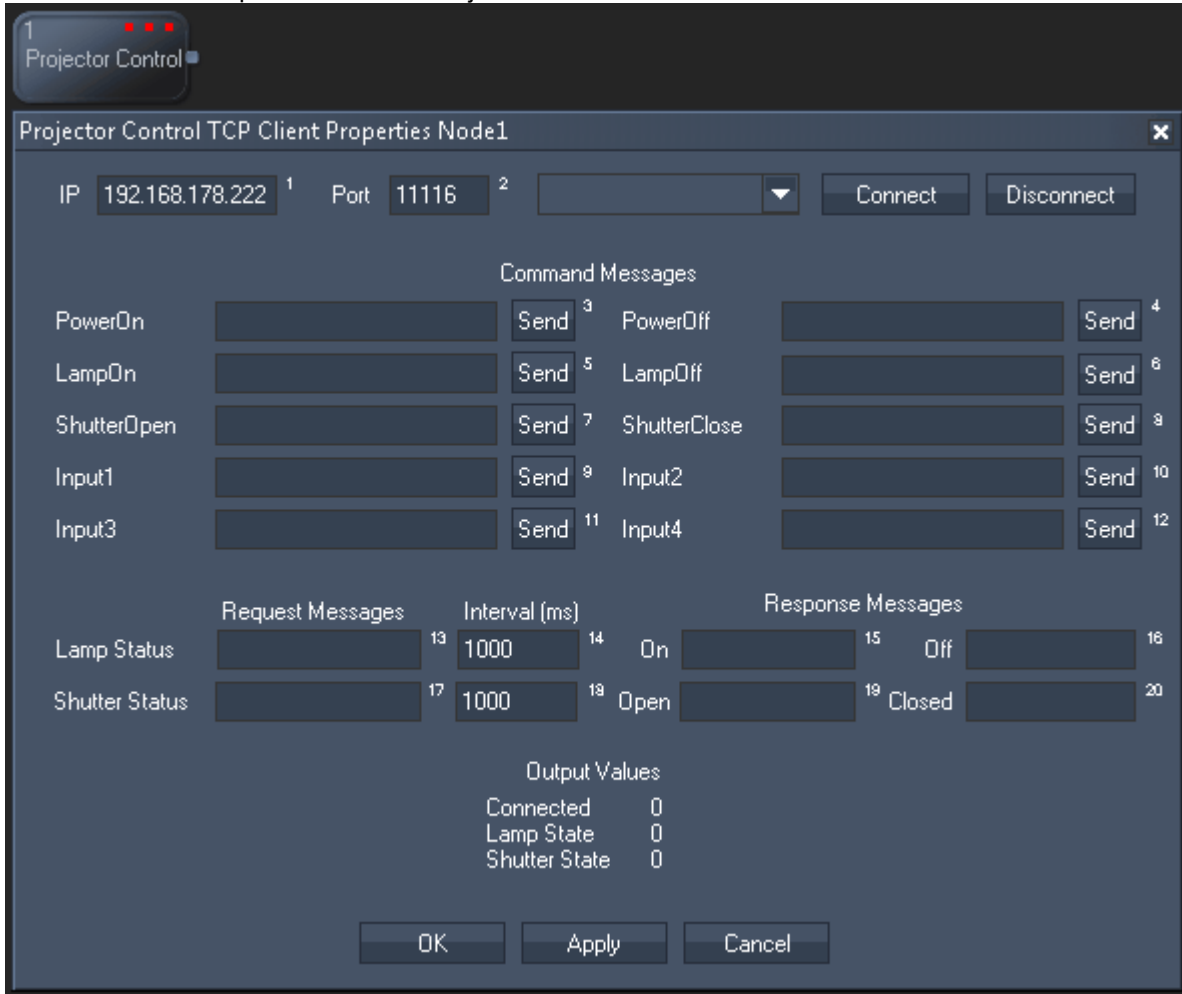

## Node properties

### IP and Port

Enter the correct IP address and port from the projector.

### Connect / Disconnect

If the connection can be enabled, the third "light" from the node changes to green; yellow indicates that the connection attempt failed whilst red means that the projector is definitely not connected, e.g. because the connection has not been initialized yet or the Disconnect button has been pressed.

### Command Messages

The Command Messages allow you to control the projector. Enter the messages for each according action. You may find the syntax in the documentation of your projector, mostly referred to as TCP or serial commands. Please note, that a carriage return or line feed could be demanded. Please see the chapter [Syntax TCP, UDP, serial messages](#)<sup>970</sup> for more information.

Click the according Send button to forward the message to the projector. Alternatively you may execute a node control as described below.

If your projector supports PJLink and the password is disabled (by using the browser control window) the syntax to turn it on would be: %1POWR 1[CR]

Projectors from Barco usually request hexadecimal commands. Please find an [example in our forum](#). To send "Lamp On" for example: [hfe h00 h00 h03 h02 h76 h1a h01 h96 hff]

### Request Messages

The Request Messages allow you to get feedback from the projector. First, enter the messages for the according request. You may find the syntax in the documentation of your projector, mostly referred to as TCP or serial commands. Please note, that a carriage return or line feed could be demanded. Please see the chapter [Syntax TCP, UDP, serial messages](#)<sup>970</sup> for more information.

Enter the time interval in which the request should be forwarded to the projector.

Lastly, enter the expected message what the projector responds, one for a positive answer and one for a negative one. As long as the request is answered positively, the according "light" of the node stays green. A negative answer is indicated by a red color.

The first light informs about the shutter state, the second about the lamp status and the third about the connection status.

### Node control

This node allows to be remote controlled via so called [node commands](#)<sup>977</sup>. Node commands access functions from a node and / or set a parameter.

Enter "node", followed by the according ID and a dot and a list will pop up showing all available commands for the node. For instance, `node1.PowerOn` will execute the function automatically without the need of opening the Item Properties dialog and clicking the according button manually.

In addition, the node properties with a parameter ID (the small superscript number) can be edited via the commands `WDNodeSetParam,NodeID,ParamID,Value` or `nodeID.ParamID@Value`.

### Node output values

The node generates the following output:

- Connected 0,1
- Lamp State 0,1
- Shutter State 0,1

### 17.4.5.46 RANDOM

The Random input node provides a random number on a given update interval and value range.

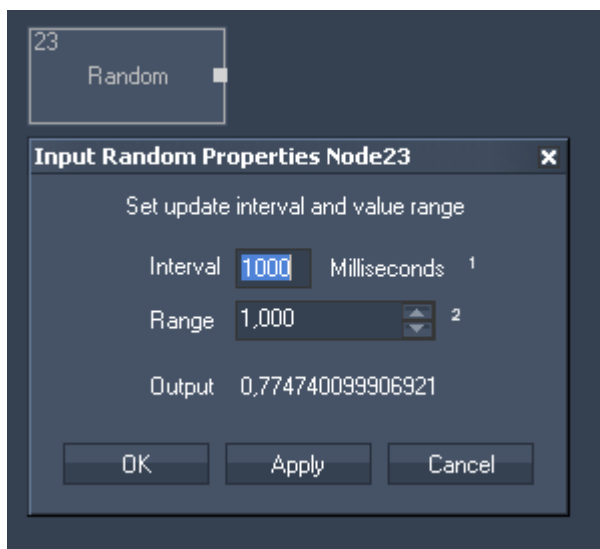

Node Properties:

Interval:

Enter the update interval in milliseconds.



Range:  
Enter the value range.

The Node generates the following output:  
- Random Value.

### 17.4.5.47 REMOTE TOUCH

The Remote Touch input node allows processing any incoming remote touch point.

The remote input needs to be set up in the [Connection Manager](#)<sup>1166</sup>.

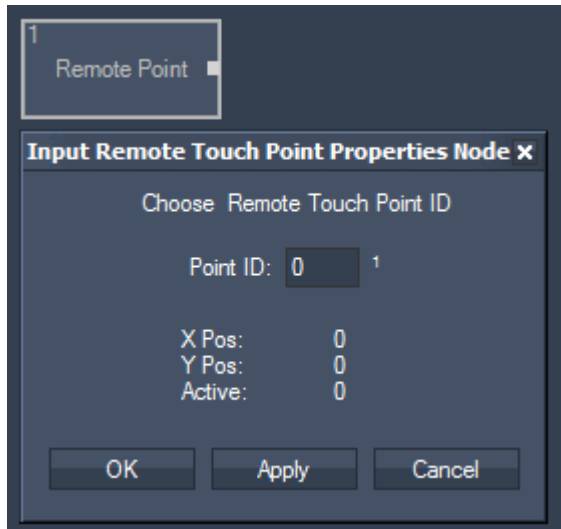

Node Properties:

Point ID:  
Enter here the ID of the incoming remote touch point you want to use for further processing.

The Node generates the following output:  
- Point X Pos  
- Point Y Pos  
- Point Active

### 17.4.5.48 RSS

The RSS input node provides all incoming RSS feeds for further processing. Please setup the RSS connection in the [RSS Settings](#)<sup>1217</sup> before.

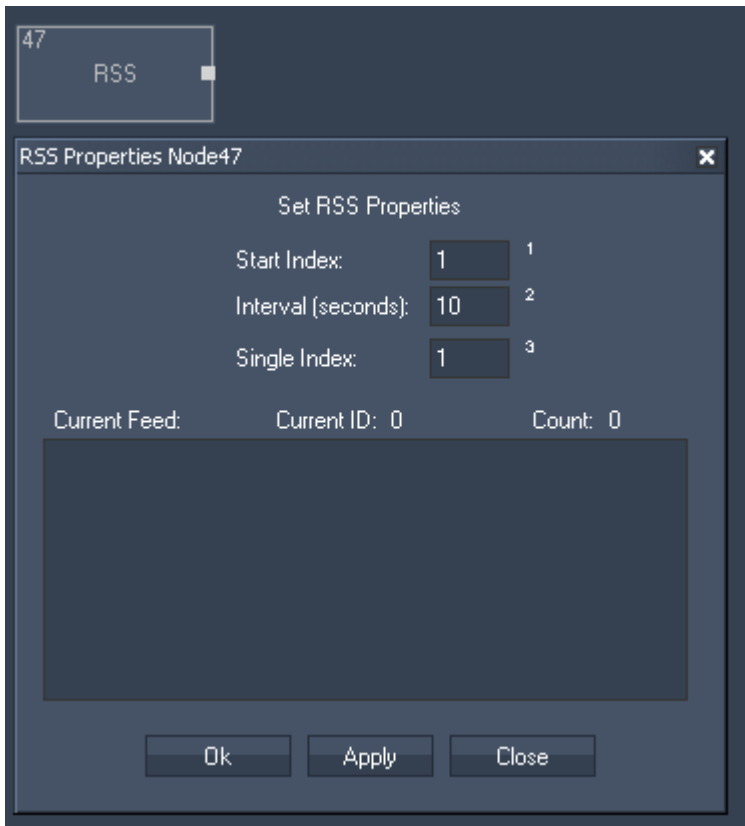

Node Properties:

**Start Index:**

Enter the Index of the RSS Feed where the cycling should start. This will affect the outputs Current RSS and Current ID.

**Interval (seconds):**

All incoming RSS Feeds will be cycling in the entered amount of time. This will affect the outputs Current RSS and Current ID.

**Single Index:**

Enter the Index of the RSS Feed that you want to route to the output Single RSS.

The Node generates the following output:

- RSS Count,
- Last RSS,
- Current RSS,
- Current ID,
- Single RSS,
- RND RSS.

### 17.4.5.49 SENSOR LINK

The Sensor Link input node provides the absolute, relative and delta values of the [Sensor Link](#)<sup>[716]</sup> device - the encoder inputs, the analog 0-10V inputs and the switch states 1 to 8.

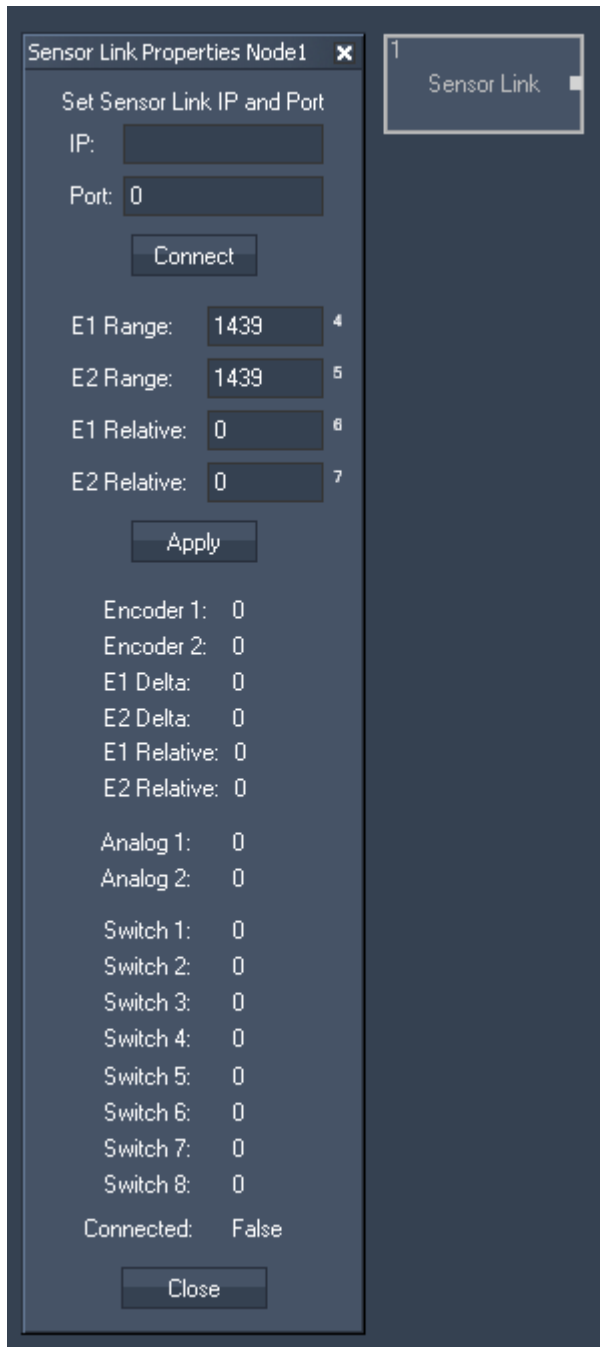

Node Properties:

Please enter the Sensor Link IP and Port number.  
Connect the WD with the Sensor Link.

E1 Range:

Enter the encoder's amount of steps. If the encoder provides 1440 steps, enter 1439 because the counting starts with zero.

Please note that the encoder's range has to be entered in the [SensorLink Configuration Tool](#)<sup>[721]</sup>, too.

---

**E2 Range:**

Enter the encoder's amount of steps. If the encoder provides 1440 steps, enter 1439 because the counting starts with zero.

Please note that the encoder's range has to be entered in the [SensorLink Configuration Tool](#)<sup>[721]</sup>, too.

**E1 Relative:**

Enter zero to reset the relative step count for the current encoder position or enter an offset value.

**E2 Relative:**

Enter zero to reset the relative step count for the current encoder position or enter an offset value.

The Node generates the following output:

- E1,
- E2,
- Analog 1,
- Analog 2,
- Switch 1,
- Switch 2,
- Switch 3,
- Switch 4,
- Switch 5,
- Switch 6,
- Switch 7,
- Switch 8,
- E1 Delta,
- E2 Delta,
- E1 Relative,
- E2 Relative,
- Link Connection State.

### 17.4.5.50 SERIAL LINK GPI

The [SerialLink<sup>729</sup>](#) input node provides all 24 GPI contact closure states. Connect a Serial Link via TCP in the [Connection Manager<sup>1166</sup>](#) and set its TCP ID in the input node to listen to the incoming packets.

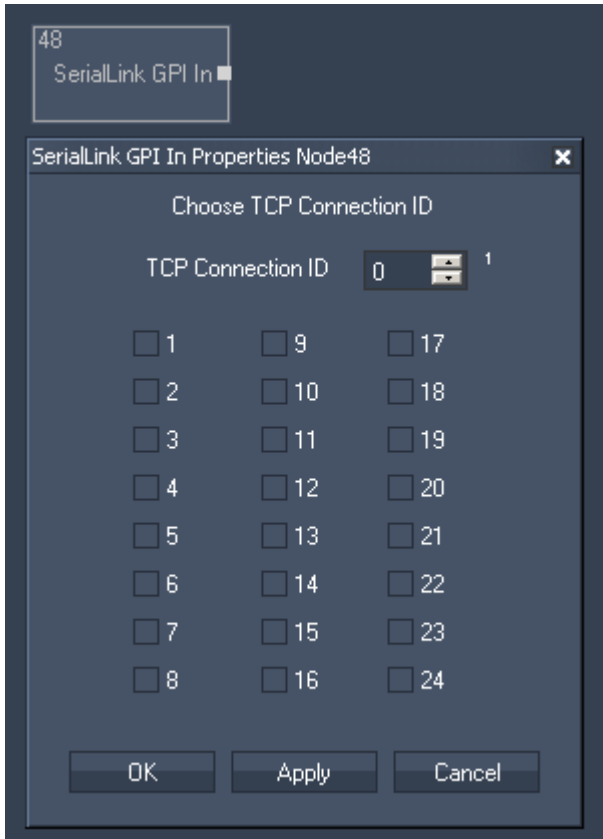

Node Properties:

TCP Connection ID:

Enter here the SerialLink's TCP Connection ID.

The Node generates the following output:

- Status for all 24 GPIs (True (10V)=1 or False (0V)=0).

### 17.4.5.51 SMS

The SMS input node provides all incoming SMS for further processing. Please setup the required GSM modem in the [SMS Settings](#)<sup>[1219]</sup> before.

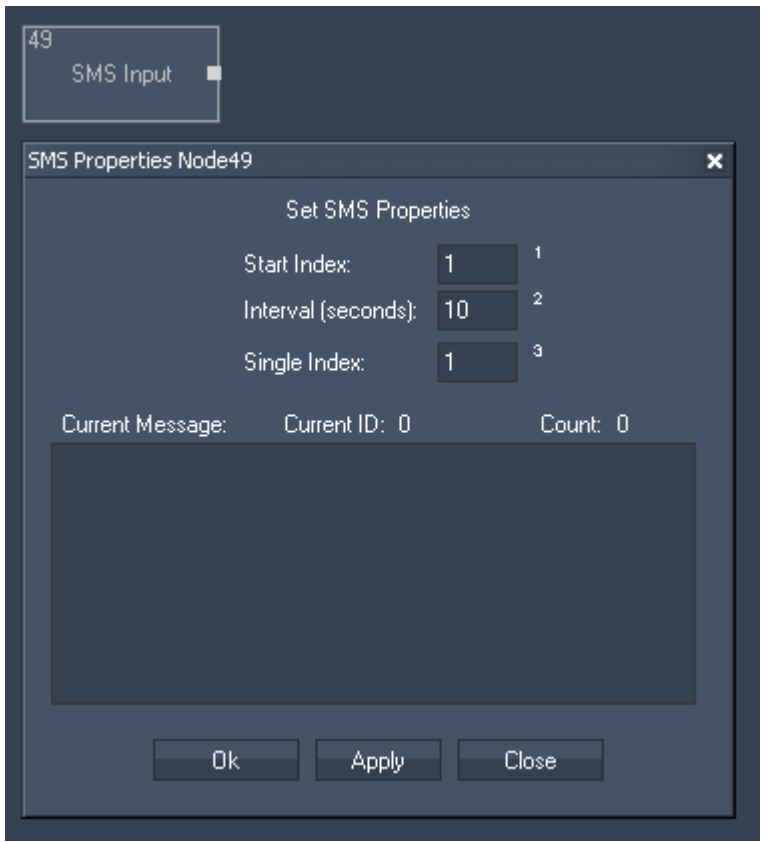

Node Properties:

**Start Index:**

Enter the Index of the start SMS, where the cycling should begin. This will effect the outputs Current SMS and Current ID.

**Interval (seconds):**

All incoming SMS will be cycling in the entered amount of time. This will effect the outputs Current SMS and Current ID.

**Single Index:**

Enter the Index of the SMS that you want to route to the output Single SMS.

The Node generates the following output:

- SMS Count,
- Last SMS,
- Current SMS,
- Current ID,
- Single SMS,
- RND SMS (Random SMS).

### 17.4.5.52 SPACE NAVIGATOR

The Space Navigator input node provides the 3D Mouse's X, Y and Z position as well as its X, Y and Z Rotation.

It is necessary to install the 3D Connexion Driver before using this tool.

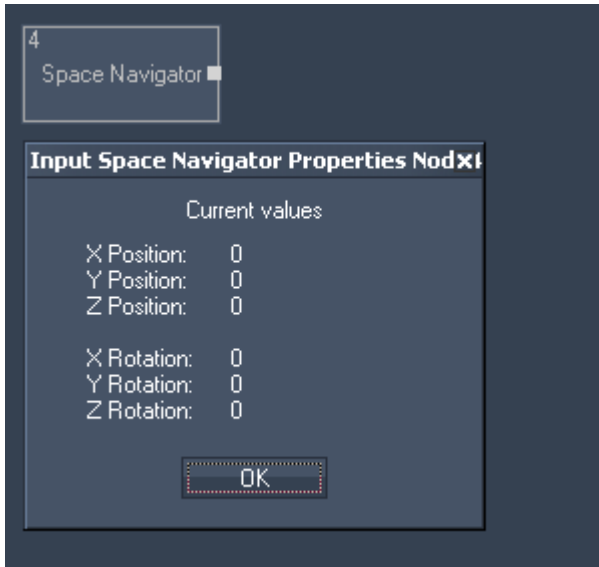

The Node generates the following output:

- X Pos,
- Y Pos,
- Z Pos,
- X Rot,
- Y Rot,
- Z Rot.

### 17.4.5.53 SMPTE LINK

The SMPTE Link input node allows reading and using timecode within Widget Designer.

The SMPTE connection needs to be enabled in the [Connection Manager](#)<sup>1166</sup>.

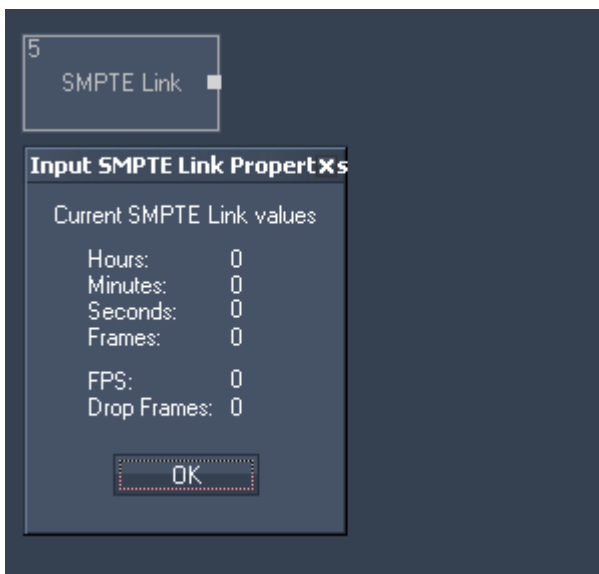

The Node generates the following output:

- Hours,
- Minutes,
- Seconds,
- Frames,
- FPS,
- Drop Frames.

#### 17.4.5.54 TEXTBOX

The Textbox input node allows intercepting Textbox Values within Widget Designer. Select the Textbox ID to output the current Textbox Value.

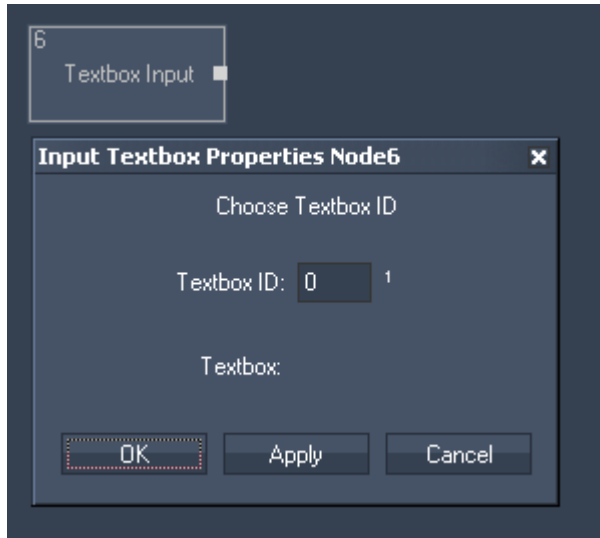

Node Properties:

Textbox ID:  
Enter the Textbox ID.

The Node generates the following output:  
- Textbox Input Value.



### 17.4.5.55 TEXT READER

The Text Reader input node allows you to read out text files (.txt) for further processing.

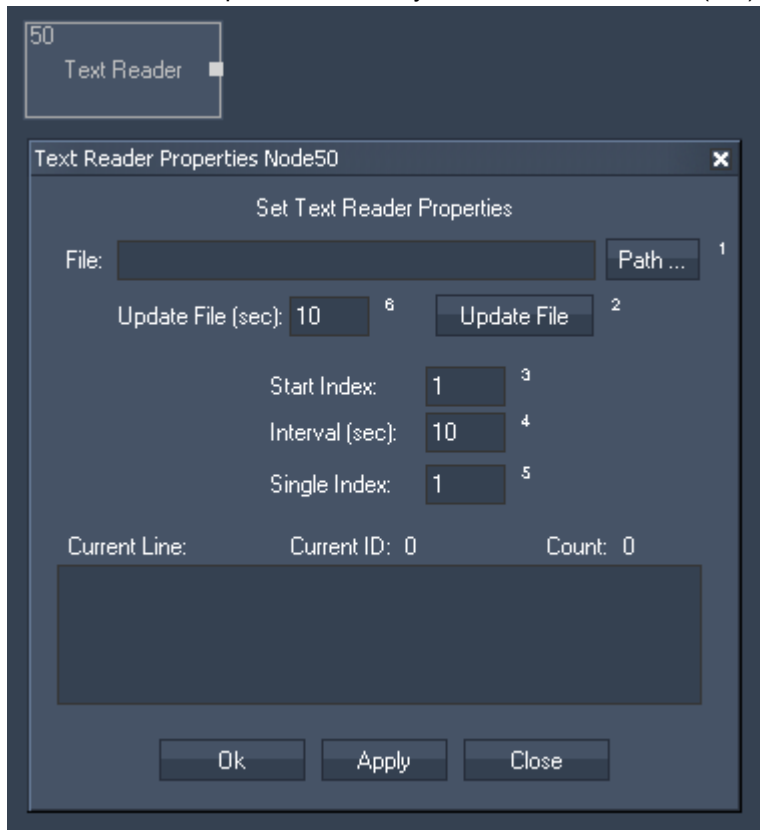

Node Properties:

File:

Click on [Path] and choose your text file via the windows browser.

Update File:

Please enter the interval time the files should be updated in seconds.  
To do it manually click on [Update File].

Start Index:

Enter the Index of the line where the cycling should start. This will affect the outputs Current Line and Current ID.

Interval (seconds):

All Text Lines will be cycling in the entered amount of time. This will affect the outputs Current Line and Current Line ID.

Single Index:

Enter the Index of the line that you want to route to the output Single Line.

The Node generates the following output:

- Text Reader Line Count,
- Text Reader Last Line,
- Text Reader Current Line,
- Text Reader Current Line ID,
- Text Reader Single Line,
- Text Reader RND Line (Random Line),
- Text Reader Entire Text.

### 17.4.5.56 TIMAX

The Timax input node provides XYZ data of the Ubisense Timax tracker.

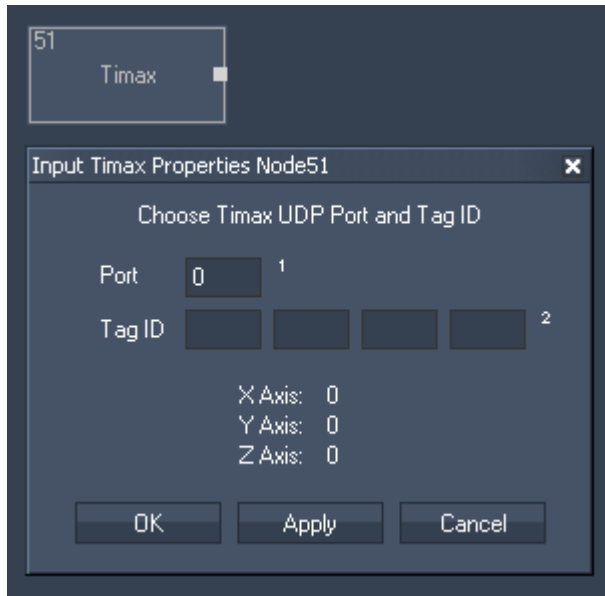

Node Properties:

Port:

Enter the Timax UDP Port.

Tag ID:

Enter the Timex Tag ID.

The Node generates the following output:

- Timax X Position,
- Timax Y Position,
- Timax Z Position.

### 17.4.5.57 TCP

The TCP input node allows receiving either ASCII or Byte values based on the selected TCP connection. It can output by default any incoming packet as text if no ASCII filter is applied. The TCP Connections can be found and setup in the [Connection Manager](#)<sup>1166</sup>.

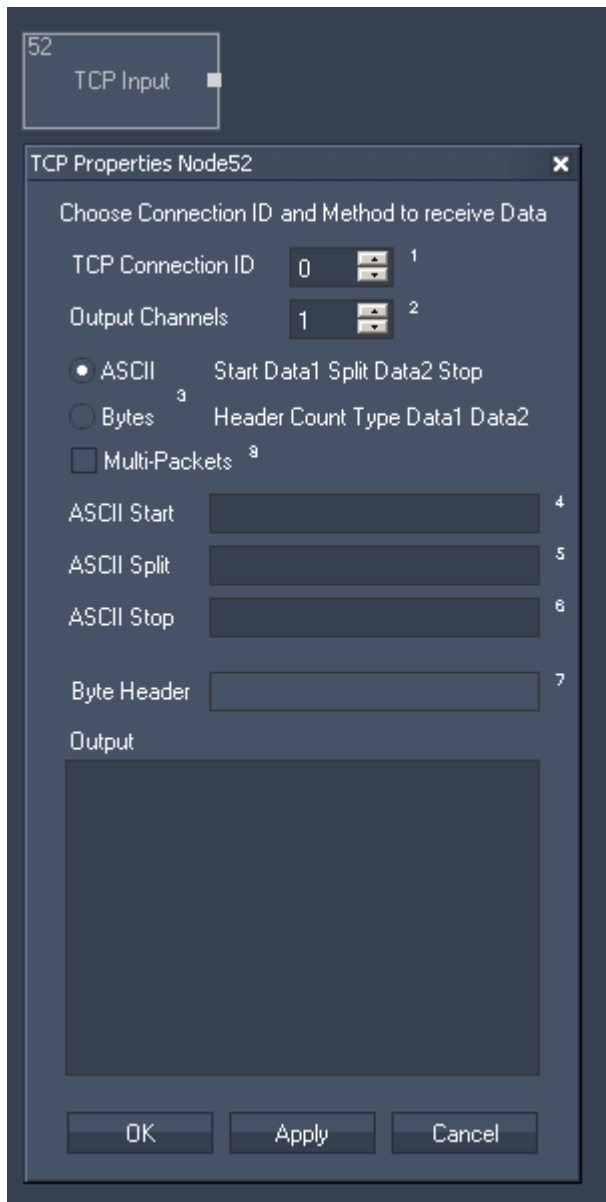

Node Properties:

TCP Connection ID:

Choose the TCP Connection to listen to. The TCP Connections can be found and setup in the [Connection Manager](#)<sup>1166</sup>.

Output Channels:

Set the Amount of Output Channels of this Input Node.

Input Value 1 will output Data 1, Input Value 2 will output Data 2, etc.

ASCII Mode:

The ASCII Mode allows creating a custom ASCII protocol for data transfer.

Multiple data can be separated by the split string.  
To determine the Start and End of the message, use the Start and Stop strings.

ASCII Start, Split and Stop:

Enter values as string, dec or hex value. Please refer to [Syntax TCP- / UDP- / Serial messages](#)<sup>970</sup>.

Bytes Mode:

The Byte protocol allows data transmission based on a byte stream.  
First send the header with any amount of Bytes,  
followed by the data count as 4 Byte integer,  
followed by a single Byte to describe the datatype used  
(1 = 4byte integer, 2 = 8byte double).

Byte Header:

Enter values as string, dec or hex value. Please refer to [Syntax TCP- / UDP- / Serial messages](#)<sup>970</sup>.

Multi-Packets:

If the TCP packets are being received in parts, this option allows reading all part packets as one.

The Node generates the following output:

- TCP Input Value 1 - Value X (X = Amount of Output Channels).

### 17.4.5.58 TCP ASCII STREAM

The TCP ASCII Stream input node allows receiving either ASCII values based on the selected TCP connection. It can output by default any incoming packet as text if no ASCII filter is applied.  
The TCP Connections can be found and setup in the [Connection Manager](#)<sup>1166</sup>.

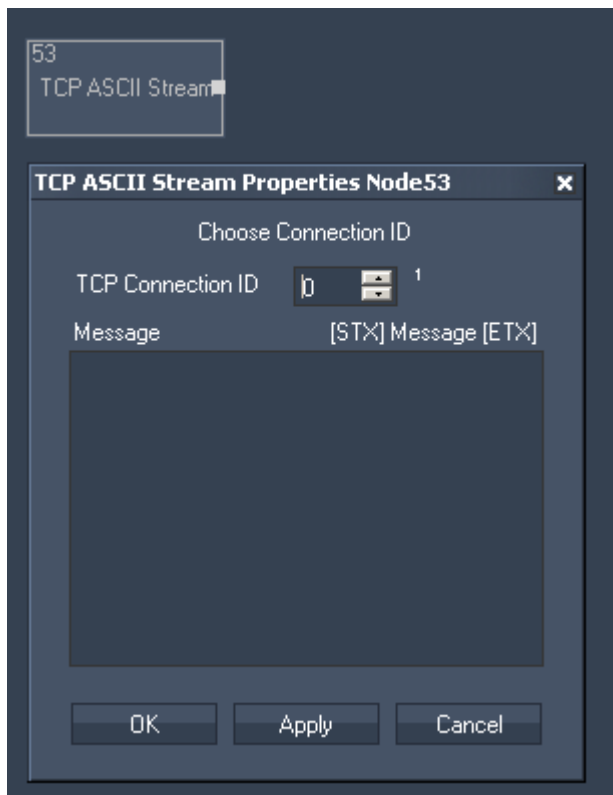

Node Properties:

TCP Connection ID:

Choose the TCP Connection to listen to. The TCP Connections can be found and setup in the [Connection Manager](#)<sup>1166</sup>.

Message:

To determine the Start and End of the message, use the Start symbol [STX] and Stop symbol [ETX] Enter values as string, dec or hex value. Please refer to [Syntax TCP- / UDP- / Serial messages](#)<sup>970</sup>.

The Node generates the following output:

- TCP Stream In String.

### 17.4.5.59 TCP QUERY STRING

The TCP Query String input node allows receiving ASCII feedback messages from TCP devices over a TCP Port connection. The TCP Port connection needs to be enabled in the [Connection Manager](#)<sup>1166</sup>.

This input node will output any incoming packet as Text Only, Numeric Only or mixed string.

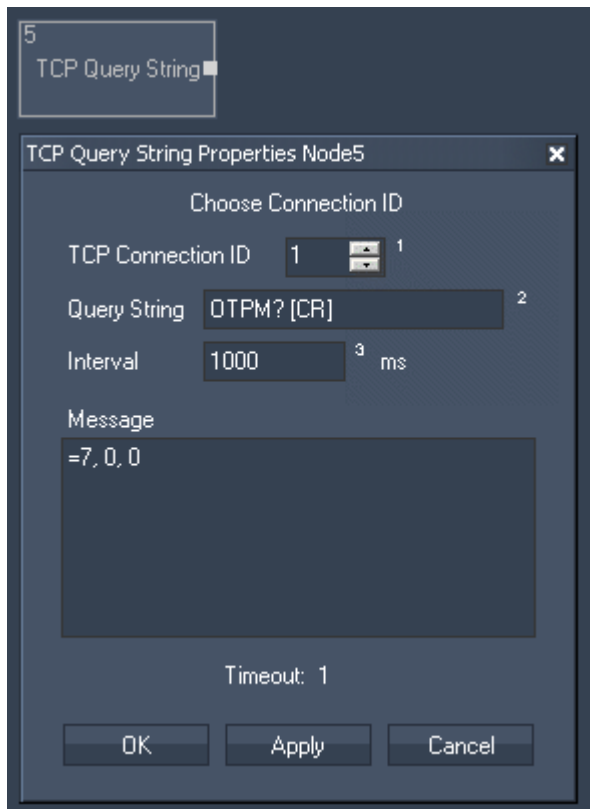

Node Properties:

TCP Connection ID:

Enter the ID of the [TCP Port Connection](#)<sup>1166</sup>

Query String:

Enter the query string that you want to send to the specified TCP Device.

Interval:

Enter the time interval in ms in which the query string will be send to the TCP Device.

---

If you want to query the device manually (e.g. by pressing a Custom Script Button using the command "[WDNodeSetParam,'NodeID','ParamID','Value'<sup>1363</sup>](#)"), please set the Interval Time to 0 ms.

#### Message:

The response of the TCP Device will be displayed here. Please note that the responding device needs to send a "carriage return", a "line feed" or an "end of text" at the end of its message. This can be done in [ASCII, decimal or hexadecimal language<sup>970</sup>](#).

- carriage return is either [CR] or [d13] or [h0D]
- line feed is either [LF] or [d3] or [h3]
- end of text is either [ETX] or [d10] or [h0A]

#### Timeout:

The Timeout gives you feedback about the connection status. If Timeout is "0", there is no communication with the specified TCP Device. If Timeout is "1" the communication works. Confirm your settings by pressing OK or Apply.

The Node generates the following output:

- TCP Query String Response,
- TCP Query String Text Only,
- TCP Query String Numeric Only
- TCP Query String Timeout.

### 17.4.5.60 TRACKSCAN

The TrackScan input node provides the integration of a Barcode scanner to read values in mm for up to 2 km of distance.

Please note:

There are two different revisions of the TrackScan device in circulation:

Rev.1 TrackScans (57600/8-N-1) only connect to the WD with this TrackScan Input Node (via the local COM Port).

Rev.2 TrackScans (9600/8-N-1) can be used with this TrackScan Input Node (via the local COM Port) and can also be connected via the [TrackScan Serial Link](#)<sup>1064</sup> Input Node (through a Serial Link Device).

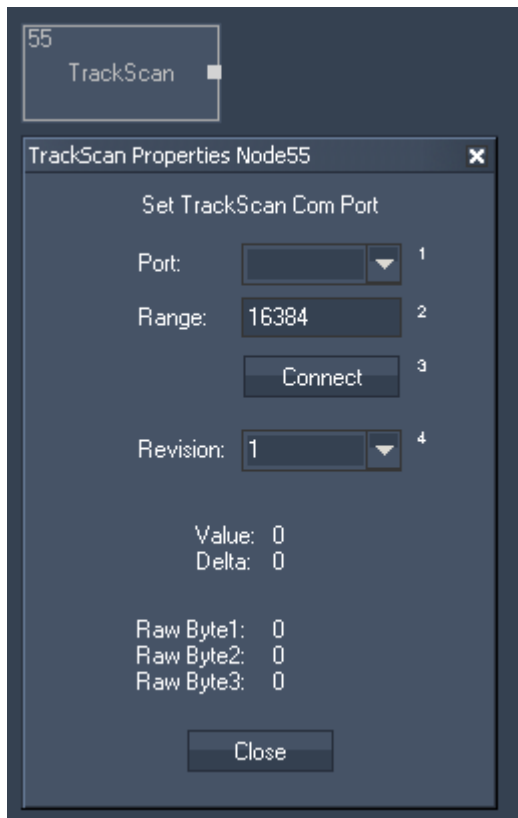

Node Properties:

Port:

Choose the TrackScan COM Port to listen to. The COM Port Connections can be found and setup in the [Connection Manager](#)<sup>1166</sup>.

Range:

The range defines the jump point of a maximum value back to zero.

The range is only important for rotating platforms, to determine the index point. Enter the range in mm.

This is only important for correct calculation of delta values when using as incremental length count.

Revision:

Please choose here the Revision of your TrackScan (1 or 2).

The Node generates the following output:

- TrackScan Value,
- TrackScan Delta,
- TrackScan Byte 1,
- TrackScan Byte 2,
- TrackScan Byte 3.

### 17.4.5.61 TRACKSCAN SERIAL LINK

The TrackScan Serial Link input node provides the integration of a Barcode scanner to read values in mm for up to 2 km of distance via the coolux SerialLink device. It requires a Serial Link to be connected as TCP client in the Connection Manager.

Please note:

There are two different revisions of the TrackScan device in circulation:

Rev.1 TrackScans (57600/8-N-1) only connect to the WD with the [TrackScan Input Node](#)<sup>1063</sup> (via the local COM Port) and not with this TrackScan Serial Link input Node!

Rev.2 TrackScans (9600/8-N-1) can be used with the TrackScan Input Node (via the local COM Port) and can also be connected via this TrackScan Serial Link Input Node (through a Serial Link Device).

Important:

The Serial Link Ports must be set to 9600 Parity off. Please make sure that TX and RX are crossed (e.g. by using gender changers and a null modem cable between Serial Link and each TrackScan)!

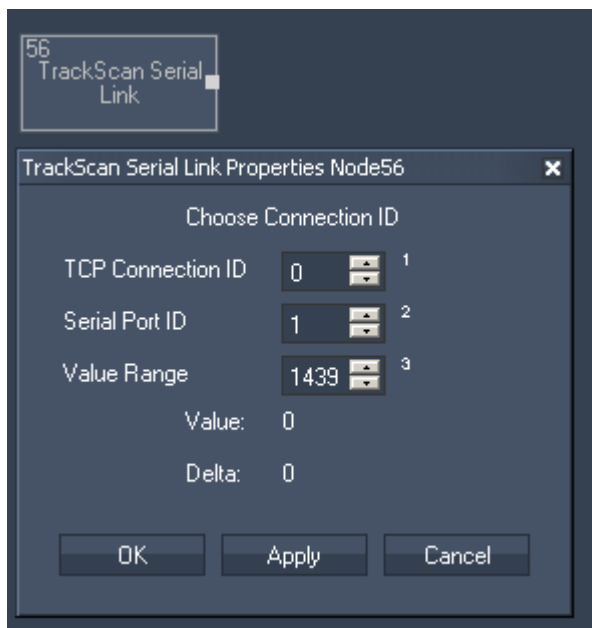

Node Properties:

TCP Connection ID:

Enter here the Serial Links Connection ID. The TCP Connections can be found and setup in the [Connection Manager](#)<sup>1166</sup>.

Serial Port ID:

Choose here the Serial Links Port ID the TrackScan is connected to.

Value Range:

The range defines the jump point of a maximum value back to zero.

The range is only important for rotating platforms, to determine the index point. Enter the range in mm.

This is only important for correct calculation of delta values when using as incremental length count.

The Node generates the following output:

- TrackScan Serial Link Value,
- TrackScan Serial Link Delta.



### 17.4.5.62 UDP

The UDP input node allows receiving either ASCII or Byte values based on the selected UDP connection. It can output by default any incoming packet as text if no ASCII filter is applied. The UDP connection can be found and set up in the [Connection Manager](#)<sup>[1166]</sup>.

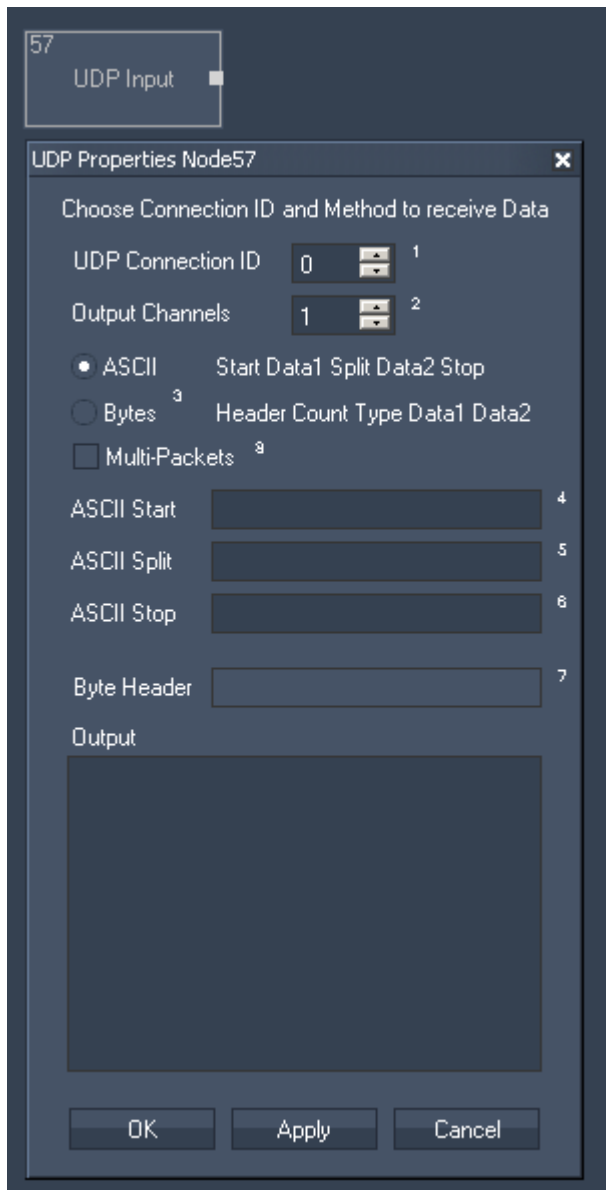

Node Properties:

UDP Connection ID:

Choose the UDP Connection to listen to. The UDP Connections can be found and setup in the [Connection Manager](#)<sup>[1166]</sup>.

Output Channels:

Set the Amount of Output Channels of this Input Node.  
Input Value 1 will output Data 1, Input Value 2 will output Data 2, etc.

ASCII Mode:

The ASCII Mode allows creating a custom ASCII protocol for data transfer.

Multiple data can be separated by the split string.  
To determine the Start and End of the message, use the Start and Stop strings.

**ASCII Start, Split and Stop:**

Enter values as string, dec or hex value. Please refer to [Syntax TCP- / UDP- / Serial messages](#)<sup>970</sup>.

**Bytes Mode:**

The Byte protocol allows data transmission based on a byte stream.  
First send the header with any amount of Bytes,  
followed by the data count as 4 Byte integer,  
followed by a single Byte to describe the data type used  
(1 = 4byte integer, 2 = 8byte double).

**Byte Header:**

Enter values as string, dec or hex value. Please refer to [Syntax TCP- / UDP- / Serial messages](#)<sup>970</sup>.

**Multi-Packets:**

If the UDP packets are being received in parts, this option allows reading all part packets as one.

The Node generates the following output:

- UDP Input Value 1 - Value X (X = Amount of Output Channels).

### 17.4.5.63 UDP ASCII STREAM

The UDP ASCII Stream input node allows receiving ASCII values based on the selected UDP connection.  
It can output by default any incoming packet as text if no ASCII filter is applied.  
The UDP connection can be found and set up in the [Connection Manager](#)<sup>1166</sup>.

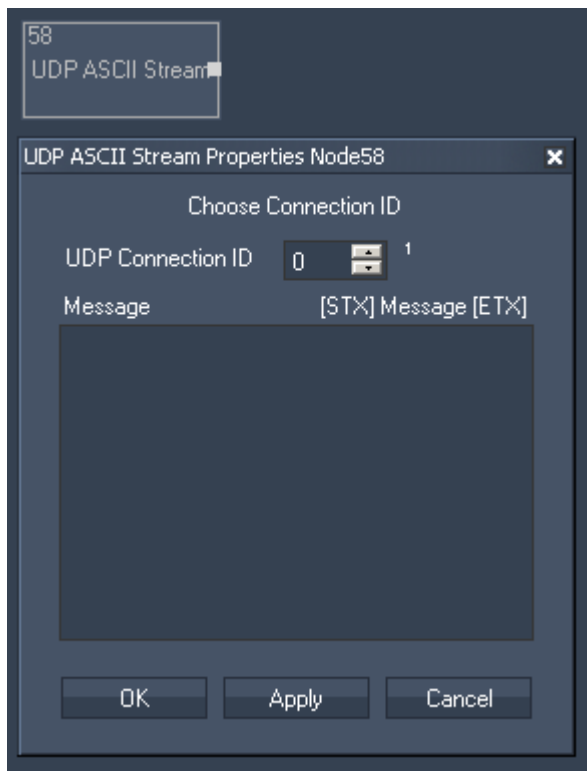

Node Properties:

UDP Connection ID:

Choose the UDP Connection to listen to. The UDP Connections can be found and setup in the [Connection Manager](#)<sup>1166</sup>.

Message:

To determine the Start and End of the message, use the Start symbol [STX] and Stop symbol [ETX] Enter values as string, dec or hex value. Please refer to [Syntax TCP- / UDP- / Serial messages](#)<sup>970</sup>.

The Node generates the following output:

- UDP Stream In String.

### 17.4.5.64 VALUE

The Value input node allows you to set a numeric value for further processing.

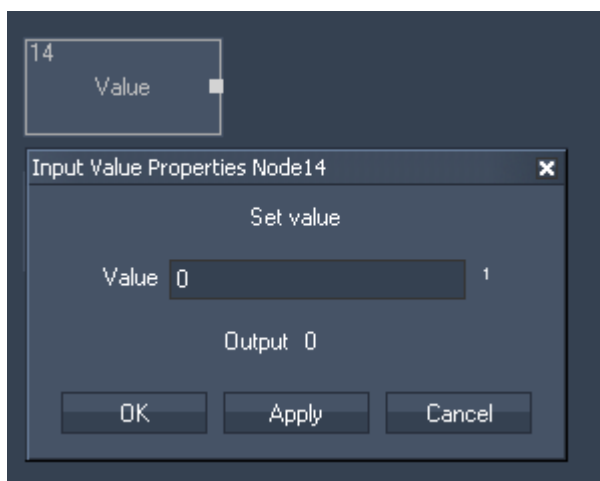

Node Properties:

Value:

Enter the numeric value.

The Node generates the following output:

- Value.

### 17.4.5.65 VARIABLE

The Variable input node allows you to use a variable for further processing.

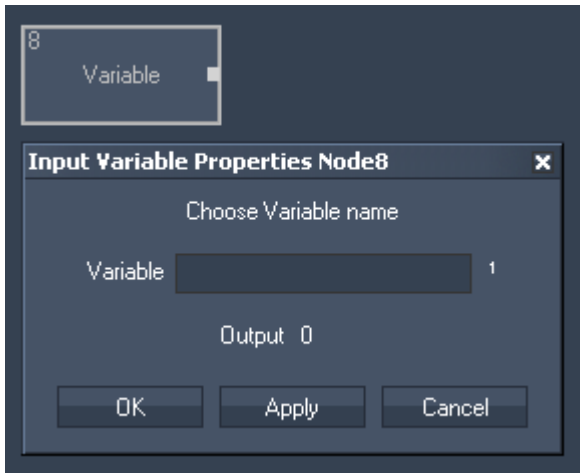

Node Properties:

Variable:

Enter the variable name.

The Node generates the following output:

- Variable.

To set up and process variables, please use [these scripts](#)<sup>1385</sup>:

To see all existing variables and their values, see the [Variable List](#)<sup>1193</sup>.

### 17.4.5.66 WHEEL

The Wheel input node allows intercepting Wheel Values within Widget Designer. Select the Wheel ID to output the current Wheel value.

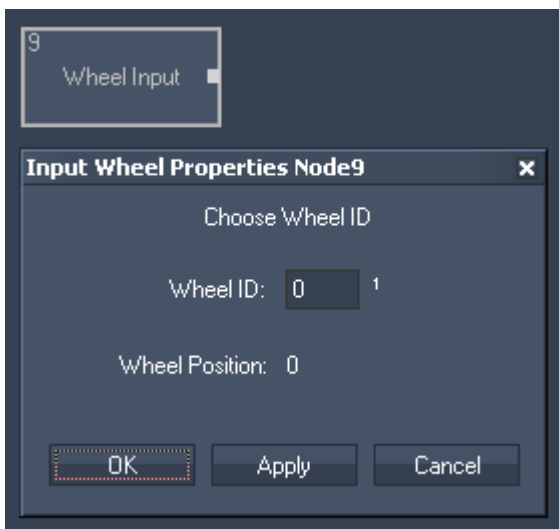

Node Properties:

Wheel ID:

Enter the Wheel ID.

The Node generates the following output:  
 - Wheel Input Value.

### 17.4.5.67 WII

The Wii input node provides all 4 IR tracking coordinates as well as all Button presses and accelerometer data for up to 4 Wii controllers. The additional Nunchuk and Balance Board are also supported. The Wii controller needs to be connected via Bluetooth as HID.



The Node generates the following output:  
 - Please see all items listed in the picture above.

### 17.4.5.68 XY PANEL

The XY Panel input node allows intercepting XY Panel Values within Widget Designer. Select the XY Panel ID to output the current XY Panel values.

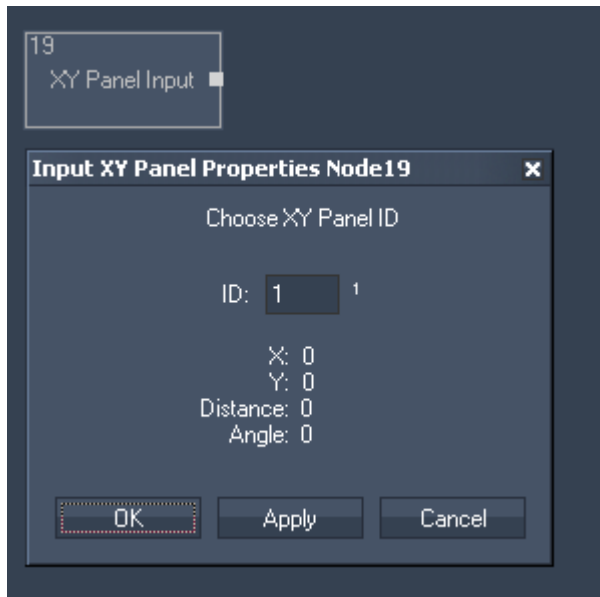

Node Properties:

ID:

Choose the XY Panel ID.

The Node generates the following output:

- Input X Position,
- Input Y Position,
- Input Distance,
- Input Angle.

### 17.4.6 FILTER NODES

Filter nodes are used between Input and Output nodes, they recalculate the input value. Please see the introductory chapter if you like to learn more about other node types or [how to create and work with nodes](#)<sup>964</sup> in general.

#### [ADD RELATIVE](#)<sup>1073</sup>

The Add Relative filter node continuously adds up incoming data. Since the Node system is updated 60 times per second the sampling speed of the node system is limited. As property windows update 25 times per second the sampling speed is increased with every property windows of an element in the node chain. It is recommended to keep all node property dialogs closed when an add relative filter node is being used.

#### [ANGLE TO POINT](#)<sup>1074</sup>

The Angle To Point filter node allows to calculate Pan and Tilt angles based on the relationship of moving targets xyz position input values according to the fixed position of the source. This node is useful to be used for tracking setups that require calculating the exact Pan and Tilt angle for remote cameras or Moving Light projectors.

#### [DAMPING PREDICTION](#)<sup>1075</sup>

The prediction based damping filter node allows reducing noisy input values and extrapolating a trend based on the history of the received values.

### [DAMPING TIMED](#)<sup>1076</sup>

The time based damping filter node allows to set a delay time for the input data to be damped.

### [DELTA](#)<sup>1077</sup>

The delta filter node allows calculating the incremental delta value of the current value vs. the last input value. The Range defines the maximum value count in case of rotary encoders that would provide the same value range per 360°.

### [DYNAMIC TRIGGER](#)<sup>1078</sup>

The Dynamic Trigger filter node allows to act as a gate with a given hold and release time and an additional target value. The Dynamic Trigger filter node is one of the few nodes that is related to the sample rate of the node system. When no node property window is opened, the filter works at the given time values. If the updates are increased by open node property dialogs of the node chain, then the timings will be affected. It is recommended to keep all node property dialogs closed when an add relative filter node is being used.

### [IF](#)<sup>1079</sup>

The If filter node allows comparing incoming data and outputs a true or false output value.

### [JITTER REDUCE](#)<sup>1080</sup>

The jitter reduce filter node allows to eliminate jittering input data, for example when using the TrackScan.

The filter updates the output value, if the input is outside the min/max range. If the input is within the min/max range, the last value is on hold.

### [MAX](#)<sup>1081</sup>

The Maximum filter node allows setting a maximum limit to input values.

### [MIN](#)<sup>1082</sup>

The Minimum filter node allows setting a minimum limit to input values.

### [POLAR > RECTANGULAR](#)<sup>1083</sup>

The Polar to Rectangular filter node allows converting radial XY values to rectangular XY values. This node is useful to convert tracking values received from a spherical surface to apply them to a two dimensional texture coordinate space.

### [RANGE ASYMMETRIC](#)<sup>1085</sup>

The Range Asymmetric node allows to convert a low and high range of an input source value and to leave a gap between the ranges. This filter is especially useful for filtering inconsistent joystick data, for example when the XY motion is mechanically snapping back to center, the center value might not always return the same values. Instead of creating a long node chain with multiple Range and min max nodes this nodes does it all in one step.

### [RANGE](#)<sup>1084</sup>

The Range filter node allows to map any input range to a new output range. You may set limits, otherwise if the input range is exceeded in both, positive or negative values, the conversion will still be applied.

## MATH FILTER NODES

The Math Filter nodes provide access to all standard math calculations.

### [ABS](#)<sup>1086</sup>

Return an absolute positive value of the input source value.

### [ACOS](#)<sup>1086</sup>

Arcus Cosine calculation.

[ADD](#)<sup>1087</sup>

Additive calculation of two source values.

[ASIN](#)<sup>1088</sup>

Arcus Sine calculation.

[ATAN](#)<sup>1088</sup>

Arcus Tangent calculation.

[CEILING](#)<sup>1089</sup>

Returns the maximum value of a decimal input value.

[COS](#)<sup>1089</sup>

Cosine calculation.

[DEGREE > RADIANS](#)<sup>1090</sup>

Converts a value from degrees to radians. This filter node is useful for cosine, sine and tangent calculation and value conversion.

[DIVIDE](#)<sup>1090</sup>

Division calculation of two source values.

[FLOOR](#)<sup>1091</sup>

Returns the minimum value of a decimal input value.

[LOG](#)<sup>1092</sup>

Logarithm calculation of the input source value.

[MODULO](#)<sup>1092</sup>

Modulo calculation of the input source value.

[MULTIPLY](#)<sup>1093</sup>

Multiplies two input source values.

[PERCENT](#)<sup>1094</sup>

Calculates the percent of an input source value.

[POWER X^Y](#)<sup>1094</sup>

Power of two input source values.

[RADIANS>DEGREE](#)<sup>1095</sup>

Converts a value from radians to degrees. This filter node is useful for cosine sine and tangent calculation and value conversion.

[ROUND](#)<sup>1096</sup>

This filter allows to round decimal values to a given amount of decimal places.

[SIN](#)<sup>1096</sup>

Sine calculation.

[SQRT](#)<sup>1097</sup>

Square Root calculation of the input source value.

[SUBTRACT](#)<sup>1098</sup>

Subtraction of two input source values.

[SUM](#)<sup>1098</sup>

Sums up all input values attached.



This is useful when connecting many delta nodes to determine easily when one of them has changed its value.

[TAN](#)<sup>1099</sup>

Tangent calculation.

### TEXT NODES

Use these nodes to handle text assets, e.g. to compare texts.

[COMPARE TEXT](#)<sup>1100</sup>

Compares two text sources.

[CONTAINS TEXT](#)<sup>1101</sup>

This filter allows scanning a text input source for specific words.

[DATE TO TEXT](#)<sup>1102</sup>

Converts numeric input values to date string.

[LEADING ZEROS](#)<sup>1103</sup>

Generates Leading Zeros for Text.

[TEXT COMBINER](#)<sup>1106</sup>

Combines up to eight text input sources or entered text to one string.

### 17.4.6.1 ADD RELATIVE

The Add Relative filter node continuously adds up incoming data. Since the Node system is updated 60 times per second the sampling speed of the node system is limited. As property windows update 25 times per second the sampling speed is increased with every property window of an element in the node chain. It is recommended to keep all node property dialogs closed when an add relative filter node is being used.

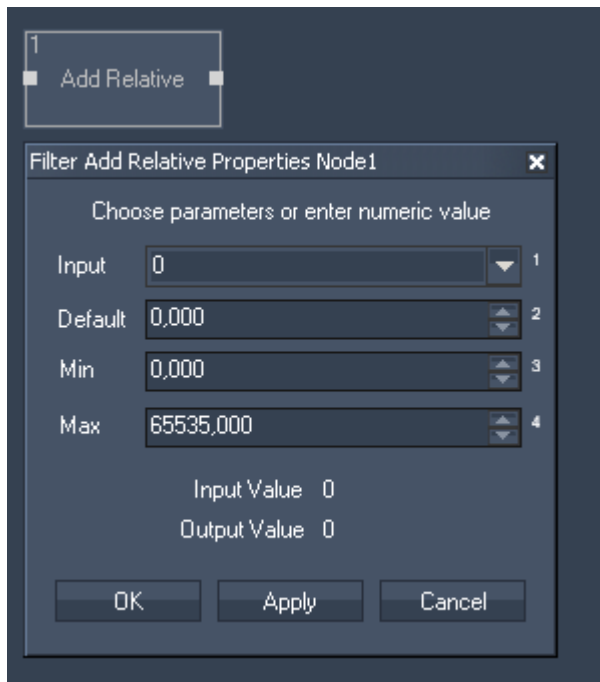

Filter Properties:

**Input:**  
Choose input node from list or enter numeric value

**Default:**  
Enter the Default Value to which the Input Values will be added.

**Min:**  
Enter the limit for the minimum output value.

**Max:**  
Enter the limit for the maximum output value.

The filter generates the following output:  
- Add Relative Output.

### 17.4.6.2 ANGLE TO POINT

The Angle To Point filter node allows to calculate Pan and Tilt angles based on the relationship of moving targets xyz position input values according to the fixed position of the source. This node is useful to be used for tracking setups that require calculating the exact Pan and Tilt angle for remote cameras or Moving Light projectors.

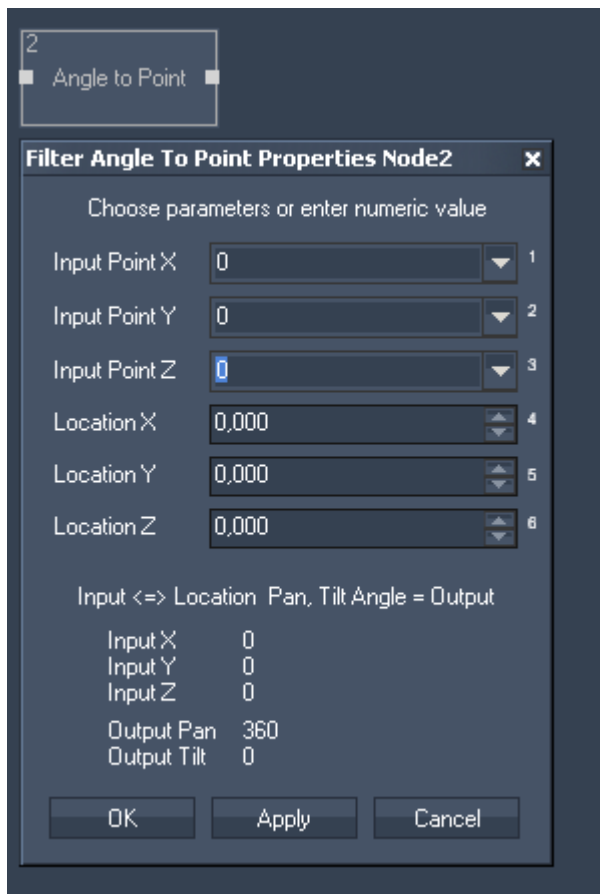

**Filter Properties:**

**Input Point X:**  
Choose input node from list or enter numeric value

Input Point Y:  
Choose input node from list or enter numeric value

Input Point Z:  
Choose input node from list or enter numeric value

Location X:  
Enter the X Position of the reference point

Location Y:  
Enter the Y Position of the reference point

Location Z:  
Enter the Z Position of the reference point

The filter generates the following outputs:  
- Pan Angle  
- Tilt Angle

### 17.4.6.3 DAMPING PREDICTION

The prediction based damping filter node allows reducing noisy input values and extrapolating a trend based on the history of the received values.

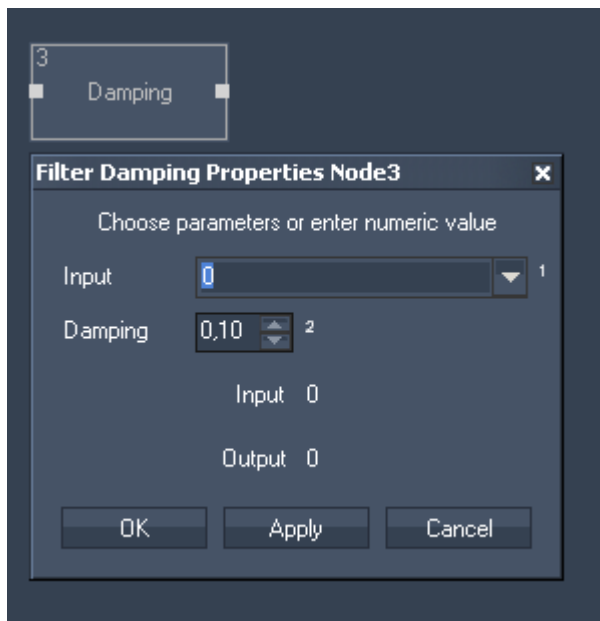

Filter Properties:

Input:  
Choose input node from list or enter numeric value

Damping:  
Enter the damping factor.  
0,1 = maximum damping  
1 = no damping

The filter generates the following output:  
- Damping Output

### 17.4.6.4 DAMPING TIMED

The time based damping filter node allows setting a delay time for the input data to be damped.

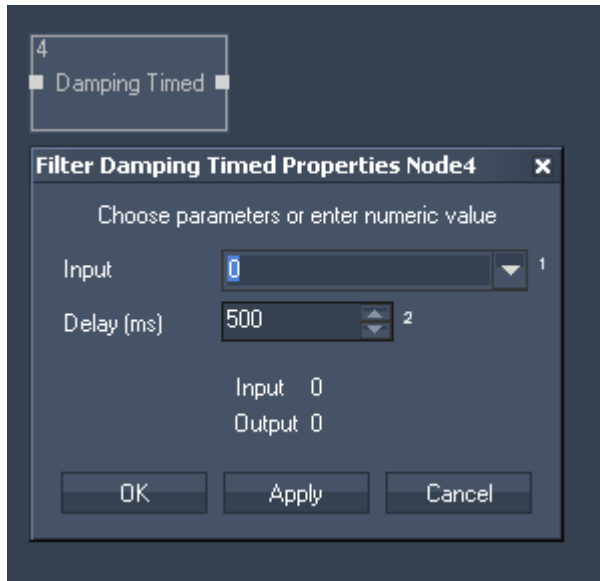

Filter Properties:

Input:

Choose input node from list or enter numeric value

Delay (ms):

Enter the delay time in milliseconds

The filter generates the following output:

- Damping Timed Result

### 17.4.6.5 DELTA

The delta filter node allows calculating the incremental delta value of the current value vs. the last input value. The Range defines the maximum value count in case of rotary encoders that would provide the same value range per 360°.

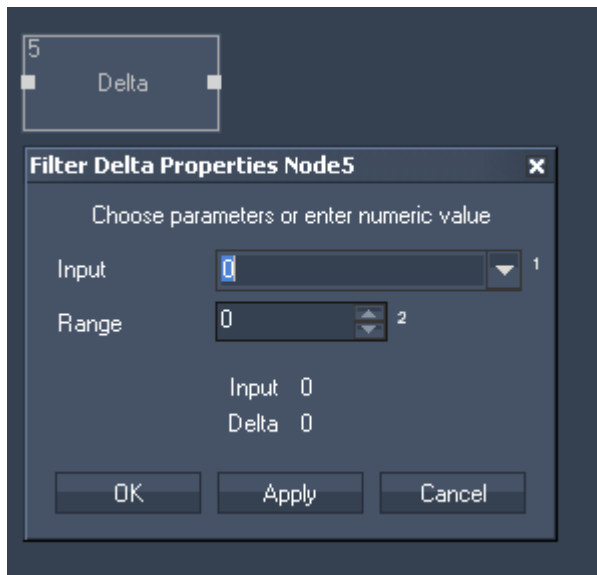

Filter Properties:

Input:

Choose input node from list or enter numeric value.

Range:

Enter maximum value if incremental values are used to calculate correct delta values between the start and end value.

You will need this for example when using encoders from 0 to 1439.

The filter generates the following output:

- Delta Output.

### 17.4.6.6 DYNAMIC TRIGGER

The Dynamic Trigger filter node allows acting as a gate with a given hold and release time and an additional target value. The Dynamic Trigger filter node is one of the few nodes that is related to the sample rate of the node system. When no node property window is opened, the filter works at the given time values. If the updates are increased by open node property dialogs of the node chain, then the timings will be affected. It is recommended to keep all node property dialogs closed when an add relative filter node is being used.

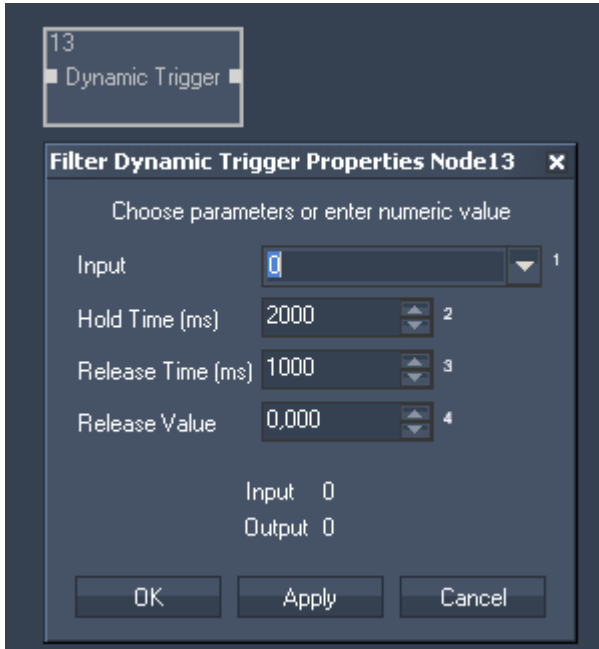

Filter Properties:

Input:

Choose input node from list or enter numeric value.

Hold Time (ms):

Enter the Hold Time in milliseconds

Release Time (ms):

Enter the Release Time in milliseconds

Release Value:

Enter the Release Value, this will be the minimum value the node gives out.

The filter generates the following output:

- Dynamic Trigger Result

### 17.4.6.7 IF

The IF filter node allows comparing incoming data and it outputs a true or false output value.

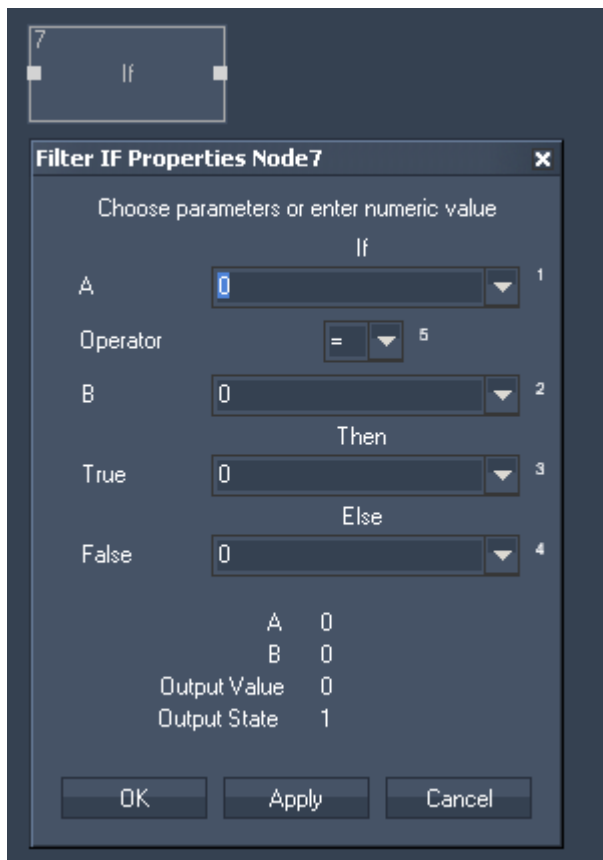

Filter Properties:

**A:**  
Choose input node from list or enter numeric value.

**Operator:**  
Choose the Operator.

**B:**  
Choose input node from list or enter numeric value.

**True:**  
If the operation is True, this input node value or entered numeric value will be given out as Output Value.

**False:**  
If the operation is False, this input node value or entered numeric value will be given out as Output Value.

The filter generates the following output:

- Output Value
- Output State (1=True, 0=False)

### 17.4.6.8 JITTER REDUCE

The jitter reduce filter node allows to eliminate jittering input data, for example when using the TrackScan.

The filter updates the output value, if the input is outside the min/max range. If the input is within the min/max range, the last value is on hold.

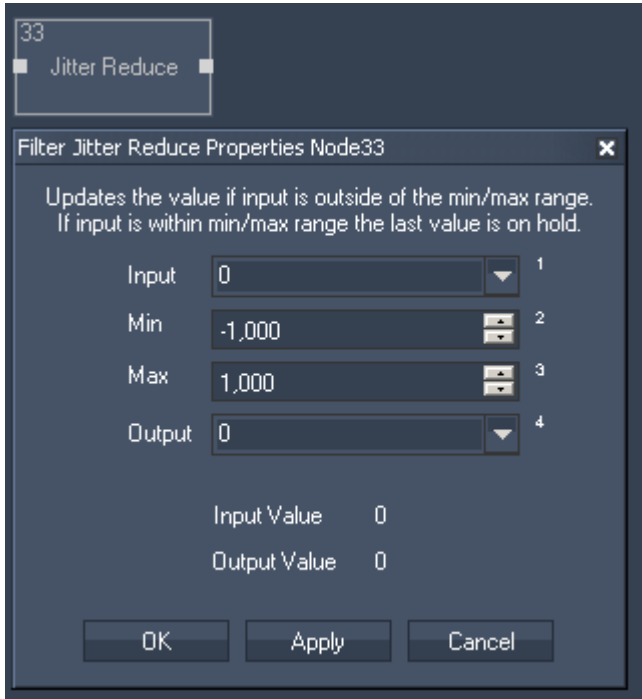

Filter Properties:

Input:

Choose input node from list (a delta value).

Min:

Enter minimum value for filtering the jitter from the delta input.

Max:

Enter maximum value for filtering the jitter from the delta input.

The filter generates the following output:

- Jitter Reduce Output.

Example:

Place a delta filter node behind your sensor input node to calculate the jittering delta. In the jitter reduce node choose the delta node output as "Input". If you do not want to route the sensor input data to an output node as long as the delta is between e.g.. -1 and 1, enter these values for min and max. Connect the sensor output node as well to the jitter reduce filter node and choose the sensors output data for "Output".



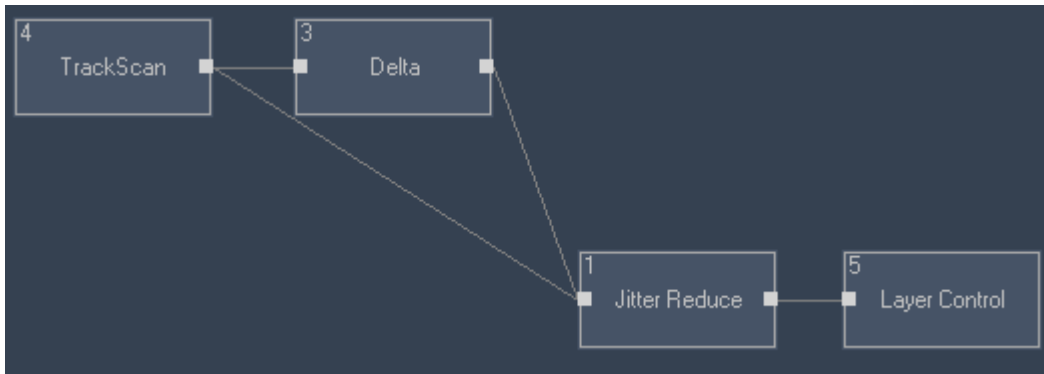

### 17.4.6.9 MAX

The Maximum filter node allows setting a maximum limit to input values.

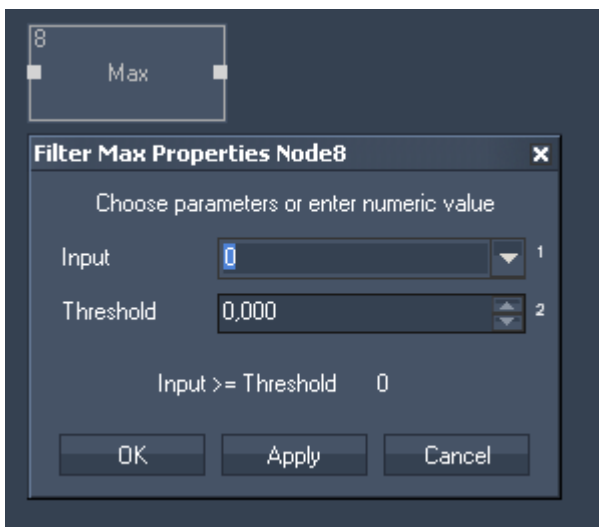

Filter Properties:

**Input:**

Choose input node from list or enter numeric value.

**Threshold:**

Choose the Threshold (maximum output value).

The filter generates the following output:

- Max Output Value

### 17.4.6.10 MIN

The Minimum filter node allows setting a minimum limit to input values.

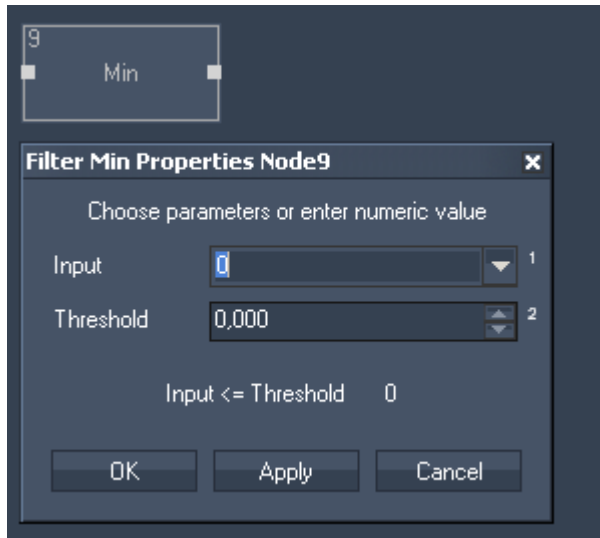

Filter Properties:

Input:

Choose input node from list or enter numeric value.

Threshold:

Choose the Threshold (minimum output value).

The filter generates the following output:

- Min Output Value

### 17.4.6.11 POLAR > RECTANGULAR

The Polar to Rectangular filter node allows converting radial XY values to rectangular XY values. This node is useful to convert tracking values received from a spherical surface to apply them to a two dimensional texture coordinate space.

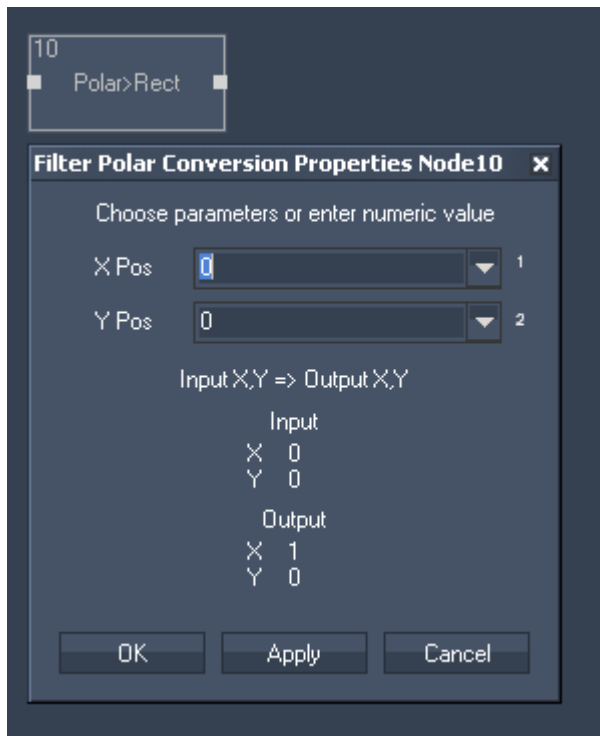

Filter Properties:

X Pos:

Choose input node from list or enter numeric value.

Y Pos:

Choose input node from list or enter numeric value.

The filter generates the following output:

- Polar>Rect X
- Polar>Rect Y

### 17.4.6.12 RANGE

The Range filter node allows mapping any input range to a new output range. You may set limits, otherwise if the input range is exceeded in both, positive or negative values, the conversion will still be applied.

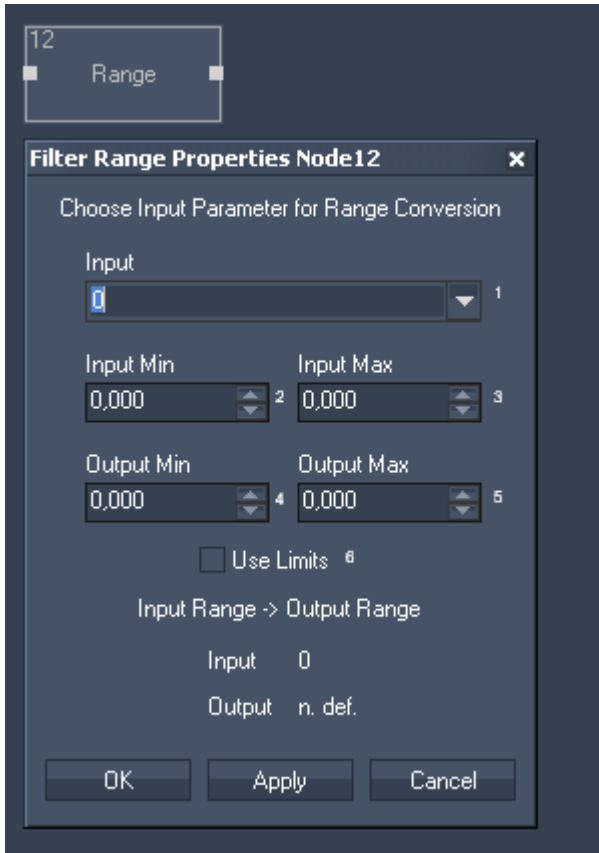

Filter Properties:

**Input:**

Choose input node from list or enter numeric value.

**Input Min:**

Enter the Input Minimum value.

**Input Max:**

Enter the Input Maximum value.

**Output Min:**

Enter the Output Minimum value. The Input Minimum value will be mapped to the Output Minimum value.

**Output Max:**

Enter the Output Minimum value. The Input Maximum value will be mapped to the Output Maximum value.

The filter generates the following output:

- Range Output.

### 17.4.6.13 RANGE ASYMMETRIC

The Range Asymmetric node allows to convert a low and high range of an input source value and to leave a gap between the ranges. This filter is especially useful for filtering inconsistent joystick data, for example when the XY motion is mechanically snapping back to center, the center value might not always return the same values. Instead of creating a long node chain with multiple Range and min max nodes this nodes does it all in one step.

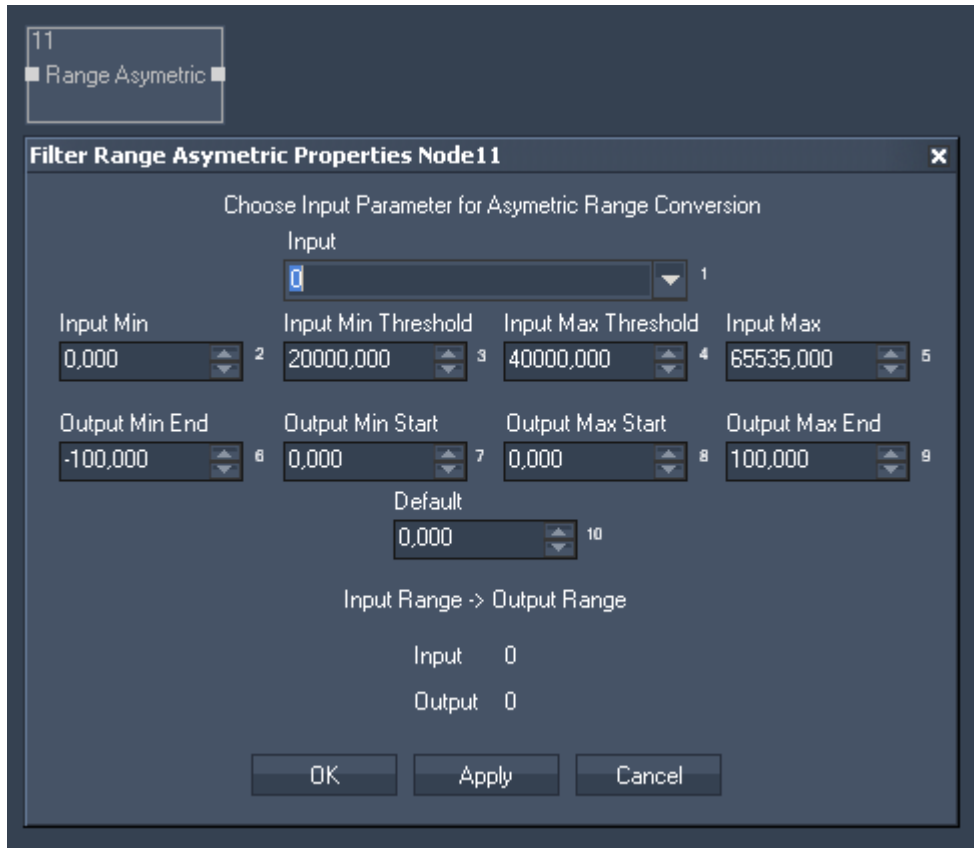

**Input:**

Choose input node from list or enter numeric value.

**Input Min / Output Min End:**

For all values below the Input Minimum the Output Min End Value will be the output.

**Input Min Threshold / Output Min End :**

For all values from Input Min up to Input Min Threshold the range between Output Min End and Output Min Start will be given out.

**Input Max Threshold / Input Max:**

For all values between Input Min Threshold and Input Max Threshold the output will be the Default Value.

**Input Max / Output Max End:**

For all values above this Input Maximum the Output Max End Value will be the output.

**Default:**

This value will be given out for all input values between Input Min and Input Max Threshold.

The filter generates the following output:

- Range Asymmetric Output

### 17.4.6.14 MATH FILTER NODES

The Math Filter nodes provide access to all standard math calculations. Please see [here](#)<sup>1071</sup> a summary of all available math nodes.

#### 17.4.6.14.1 ABS

Returns an absolute positive value of the input source value.

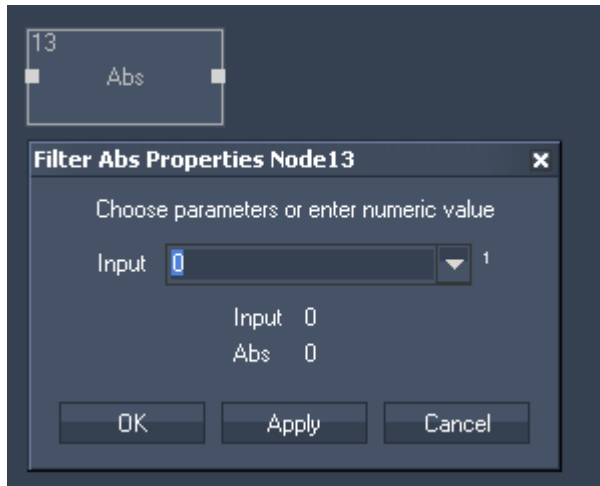

Filter Properties:

Input:

Choose input node from list or enter numeric value.

The filter generates the following output:

- Abs Output

#### 17.4.6.14.2 ACOS

Arcus Cosine calculation.

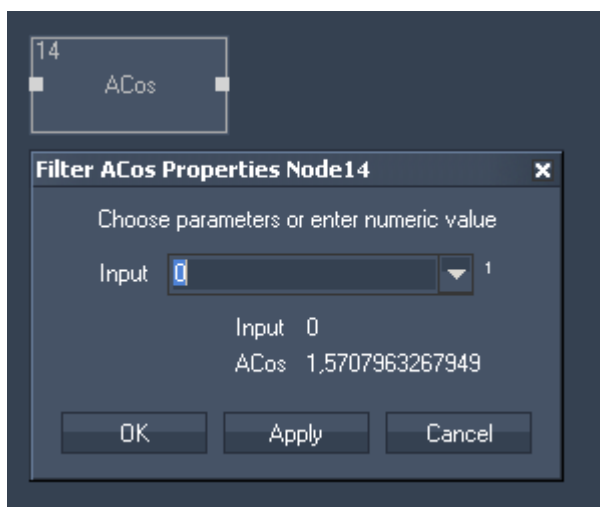

Filter Properties:

Input:  
Choose input node from list or enter numeric value.

The filter generates the following output:  
- ACos Output

### 17.4.6.14.3 ADD

Additive calculation of two source values.

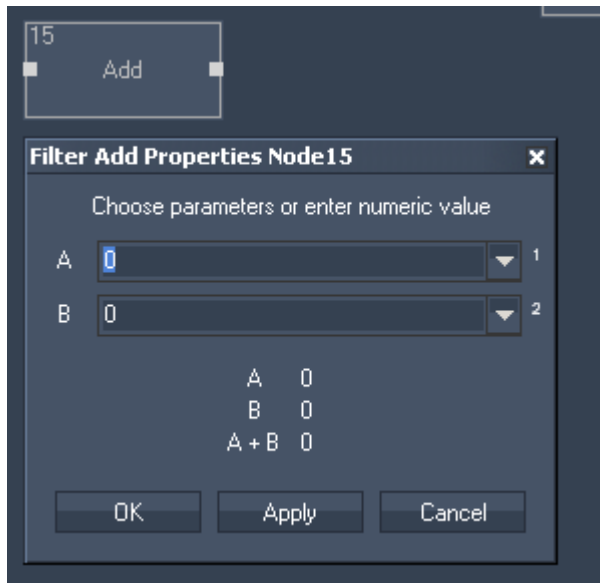

Filter Properties:

Input A:  
Choose first input node from list or enter numeric value.

Input B:  
Choose second input node from list or enter numeric value.

The filter generates the following output:  
- Add Result: Input A + Input B.

### 17.4.6.14.4 ASin

Arcus Sine calculation.

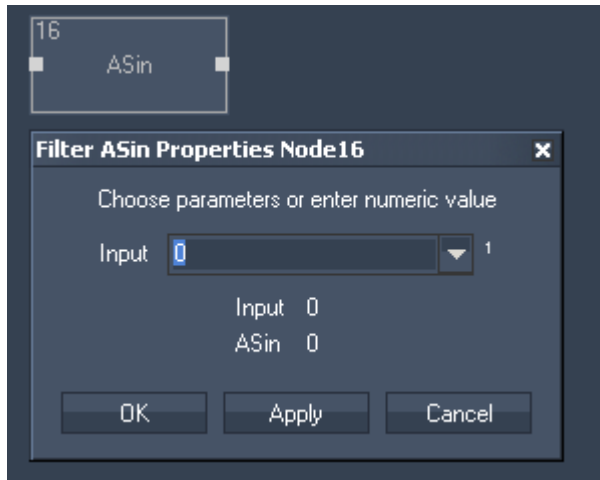

Filter Properties:

Input:

Choose input node from list or enter numeric value.

The filter generates the following output:

- ASin Result.

### 17.4.6.14.5 ATan

Arcus Tangent calculation.

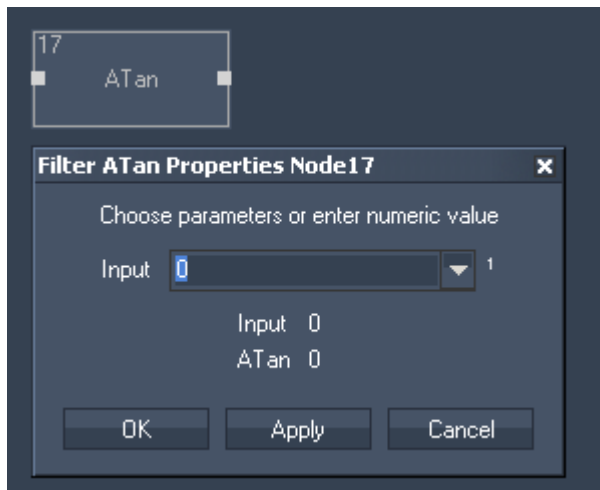

Filter Properties:

Input:

Choose input node from list or enter numeric value.

The filter generates the following output:

- ATan Result.



### 17.4.6.14.6 CEILING

Returns the maximum value of a decimal input value.

For example: Input value 5,1 results in the output value 6.

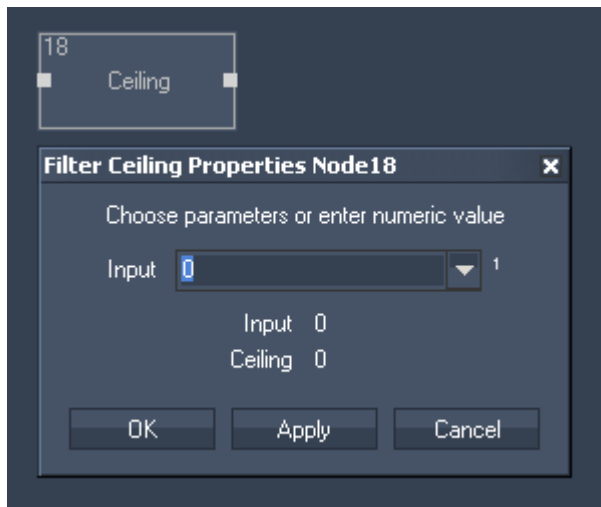

Filter Properties:

Input:

Choose input node from list or enter numeric value.

The filter generates the following output:

- Ceiling Result.

### 17.4.6.14.7 COS

Cosine calculation.

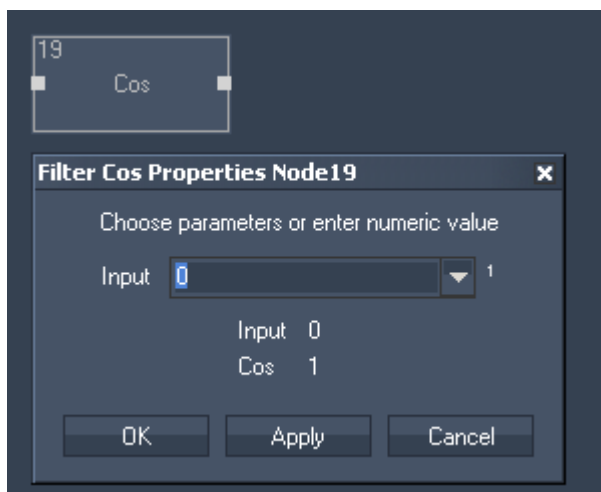

Filter Properties:

Input:

Choose input node from list or enter numeric value.

The filter generates the following output:  
 - Cosinus Result.

### 17.4.6.14.8 DEGREE > RADIANS

Converts a value from degrees to radians. This filter node is useful for cosine, sine and tangent calculation and value conversion.

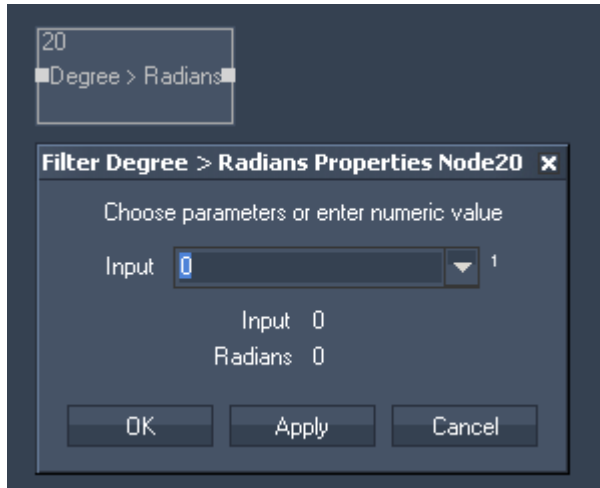

Filter Properties:

Input:  
 Choose input node from list or enter numeric value.

The filter generates the following output:  
 - Radians Result.

### 17.4.6.14.9 DIVIDE

Division calculation of two source values.

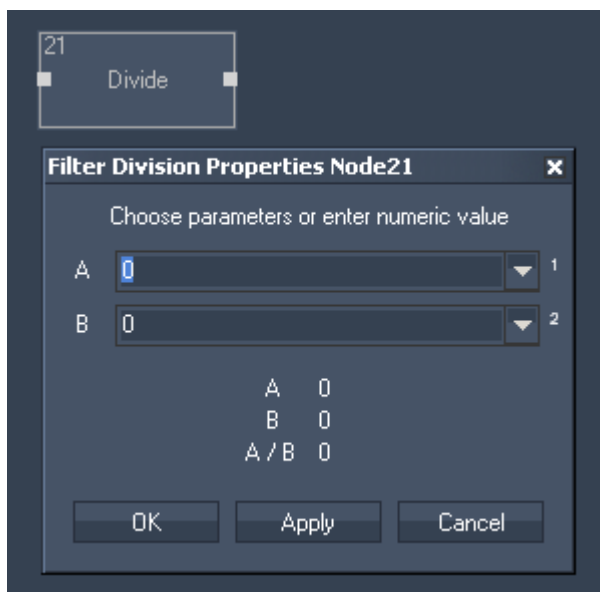

Filter Properties:

Input A:

Choose input node from list or enter numeric value.

Input B:

Choose input node from list or enter numeric value.

The filter generates the following output:

- Divide Result.

### 17.4.6.14.10 FLOOR

Returns the minimum value of a decimal input value.

For example: Input value of 4,3 will result in the Output value 4.

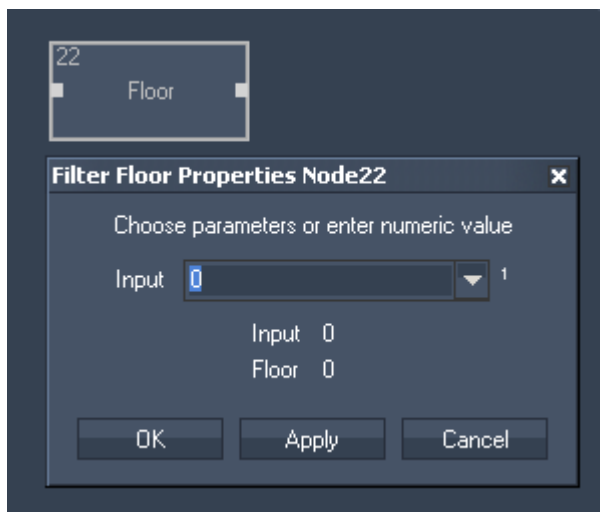

Filter Properties:

Input:

Choose input node from list or enter numeric value.

The filter generates the following output:

- Floor Result

### 17.4.6.14.11 LOG

Logarithm calculation of the input source value.

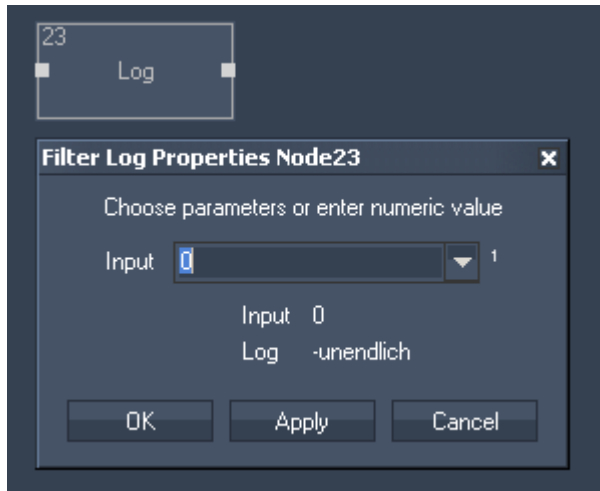

Filter Properties:

Input:

Choose input node from list or enter numeric value.

The filter generates the following output:

- Logarithm Result.

### 17.4.6.14.12 MODULO

Modulo calculation of the input source value.

For Example: 7 modulo 3 = 1.

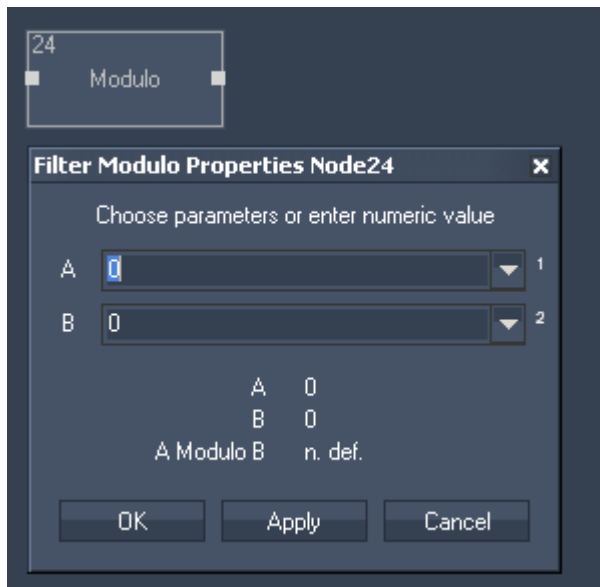

Filter Properties:

Input A:

Choose input node from list or enter numeric value.

Input B:

Choose input node from list or enter numeric value.

The filter generates the following output:

- Modulo Result.

### 17.4.6.14.13 MULTIPLY

Multiplies two input source values.

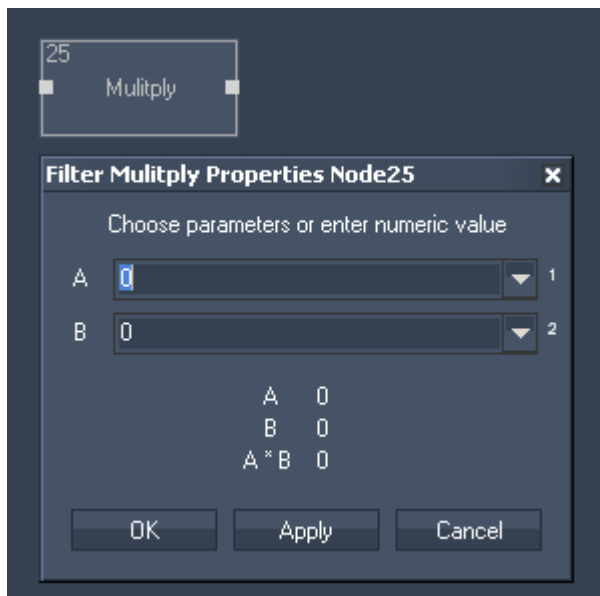

Filter Properties:

Input A:

Choose input node from list or enter numeric value.

Input B:

Choose input node from list or enter numeric value.

The filter generates the following output:

- Multiply Result.

### 17.4.6.14.14 PERCENT

Calculates the percent of an input source value.

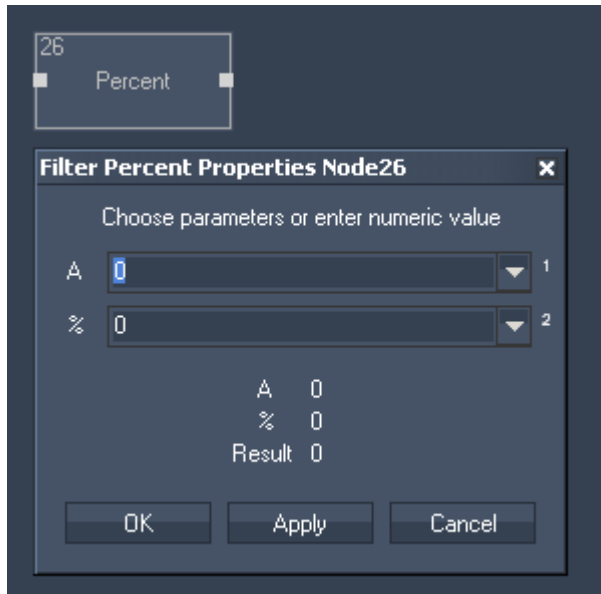

Filter Properties:

Input A:

Choose input node from list or enter numeric value.

Input %:

Choose input node from list or enter numeric value.

The filter generates the following output:

- Percent Result.

### 17.4.6.14.15 POWER X^Y

Power of two input source values.

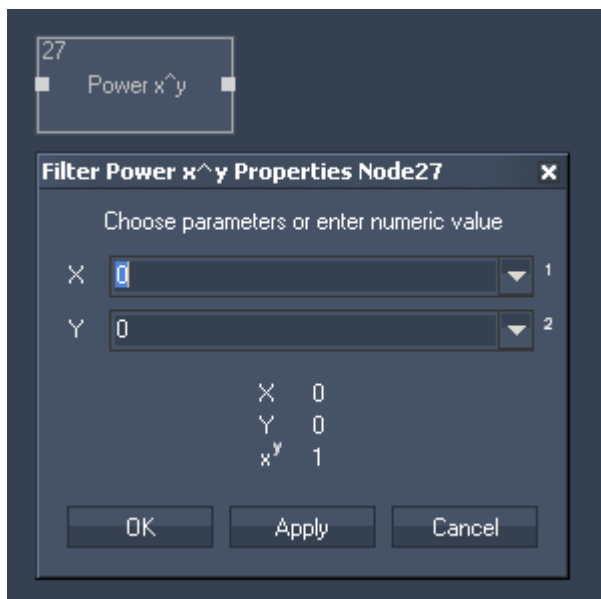

Filter Properties:

Input X

Choose input node from list or enter numeric value.

Input Y:

Choose input node from list or enter numeric value.

The filter generates the following output:

- Power Result.

### 17.4.6.14.16 RADIANS>DEGREE

Converts a value from radians to degrees. This filter node is useful for cosine sine and tangent calculation and value conversion.

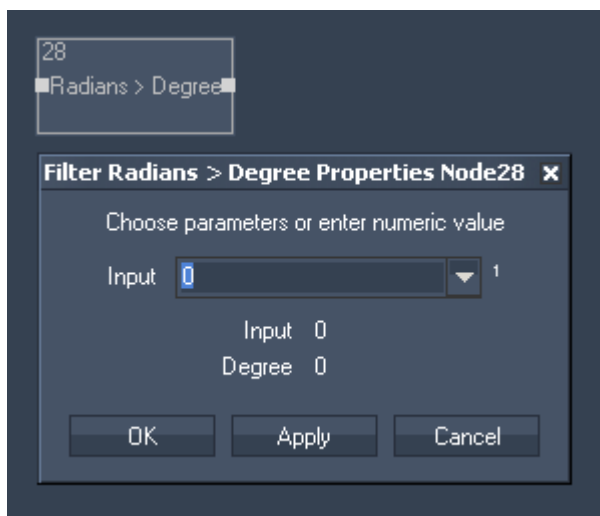

Filter Properties:

Input:

Choose input node from list or enter numeric value.

The filter generates the following output:

- Radians>Degree Result.

### 17.4.6.14.17 ROUND

This filter allows to round decimal values to a given amount of decimal places.  
 For Example: Input value 7,633 rounded to 1 digit results in the output value 7,7.

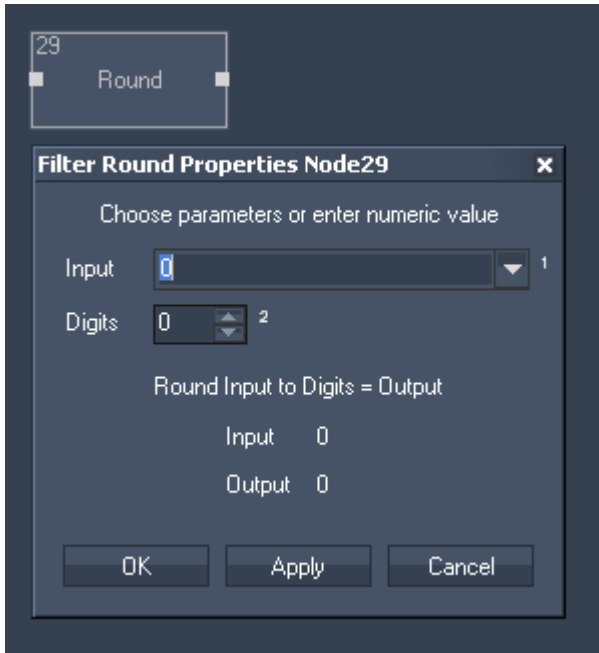

Filter Properties:

Input:  
 Choose input node from list or enter numeric value.

Digits:  
 Enter amount of decimal places.

The filter generates the following output:  
 - Round Result.

### 17.4.6.14.18 SIN

Sine calculation.

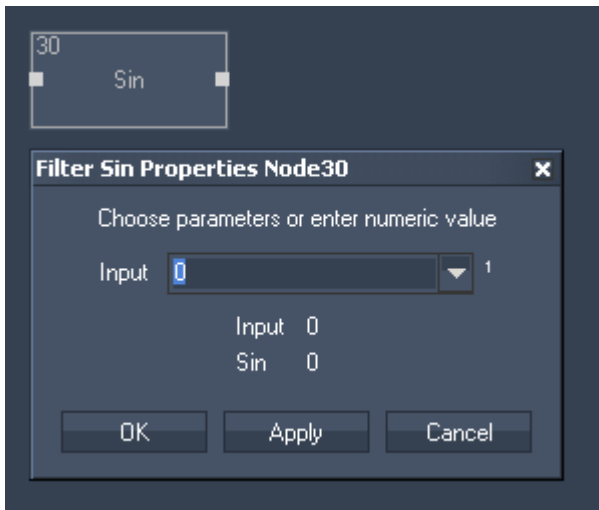



Filter Properties:

Input:

Choose input node from list or enter numeric value.

The filter generates the following output:

- Sin Result.

#### 17.4.6.14.19 SQRT

Square Root calculation of the input source value.

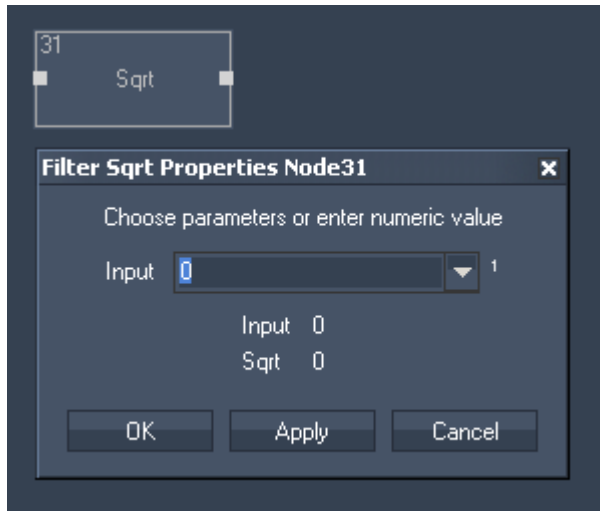

Filter Properties:

Input:

Choose input node from list or enter numeric value.

The filter generates the following output:

- Square Root Result.

### 17.4.6.14.20 SUBTRACT

Subtraction of two input source values.

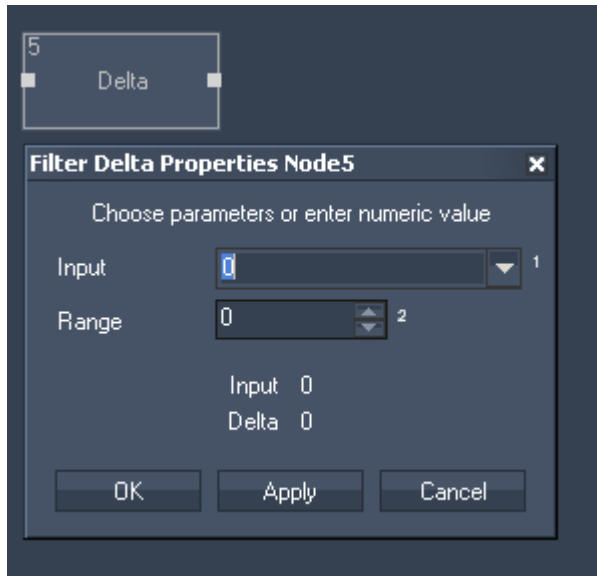

Filter Properties:

Input A:

Choose input node from list or enter numeric value.

Input B:

Choose input node from list or enter numeric value.

The filter generates the following output:

- Subtract Result.

### 17.4.6.14.21 SUM

The Filter Node SUM allows summing up all input values attached.

This is useful when connecting many delta nodes to determine easily when one of them has changed its value.

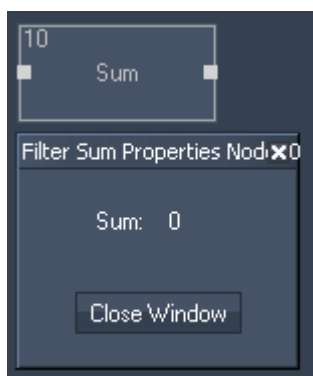

Filter Properties:

The filter generates the following output:

- Sum.

### 17.4.6.14.22 TAN

Tangent calculation.

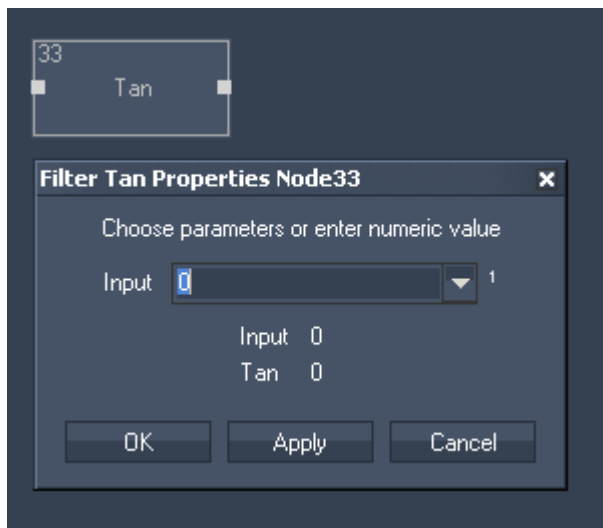

Filter Properties:

Input A:

Choose input node from list or enter numeric value.

The filter generates the following output:

- Tangent Result.

### 17.4.6.15 TEXT FILTER NODES

Use these nodes to handle text assets, e.g. to compare texts. Please see [here](#)<sup>1073</sup> a summary of all available text nodes.

#### 17.4.6.15.1 COMPARE TEXT

Compares two text sources.

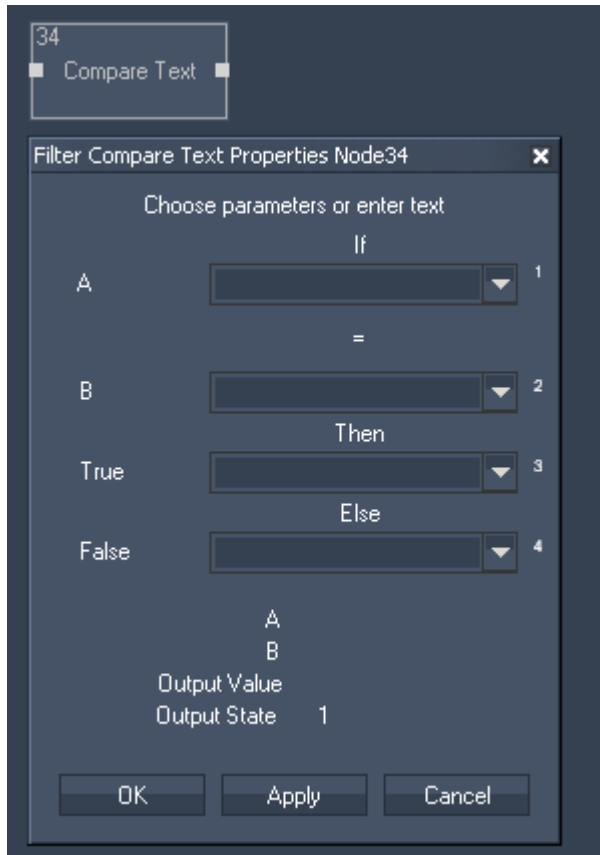

Filter Properties:

Input A:

Choose input node from list or enter text.

Input B:

Choose input node from list or enter text.

True:

Choose input node from list or enter text that should be the output if the result is true.

False:

Choose input node from list or enter text that should be the output if the result is false.

The filter generates the following output:

- Compare Output value
- Compare State (true=1 or false=0)

### 17.4.6.15.2 CONTAINS TEXT

This filter allows scanning a text input source for specific words.

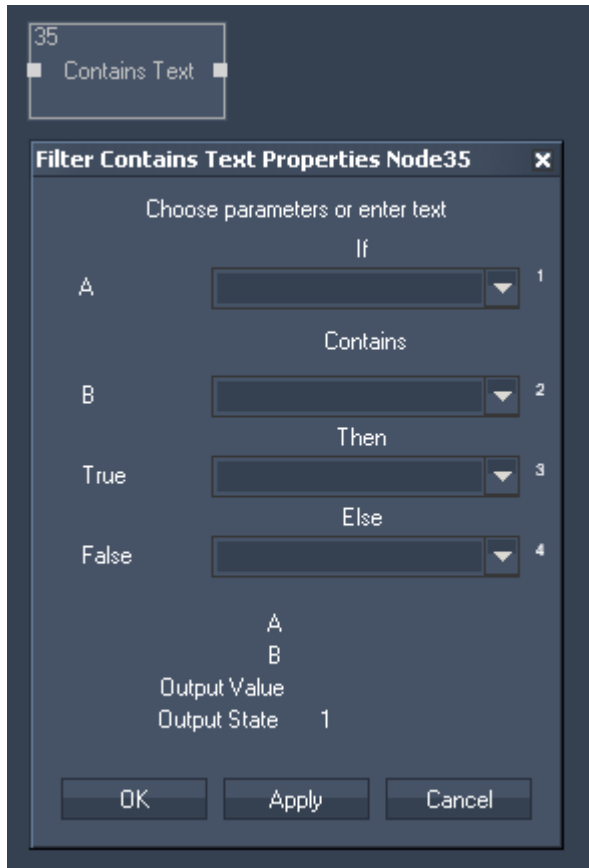

Filter Properties:

Input A:

Choose input node from list or enter text.

Input B:

Choose input node from list or enter text.

True:

Choose input node from list or enter text that should be the output if the result is true.

False:

Choose input node from list or enter text that should be the output if the result is false.

The filter generates the following output:

- Contains Output Value
- Contains Output State (true=1 or false=0)

### 17.4.6.15.3 DATE TO TEXT

Converts numeric input values to date string.

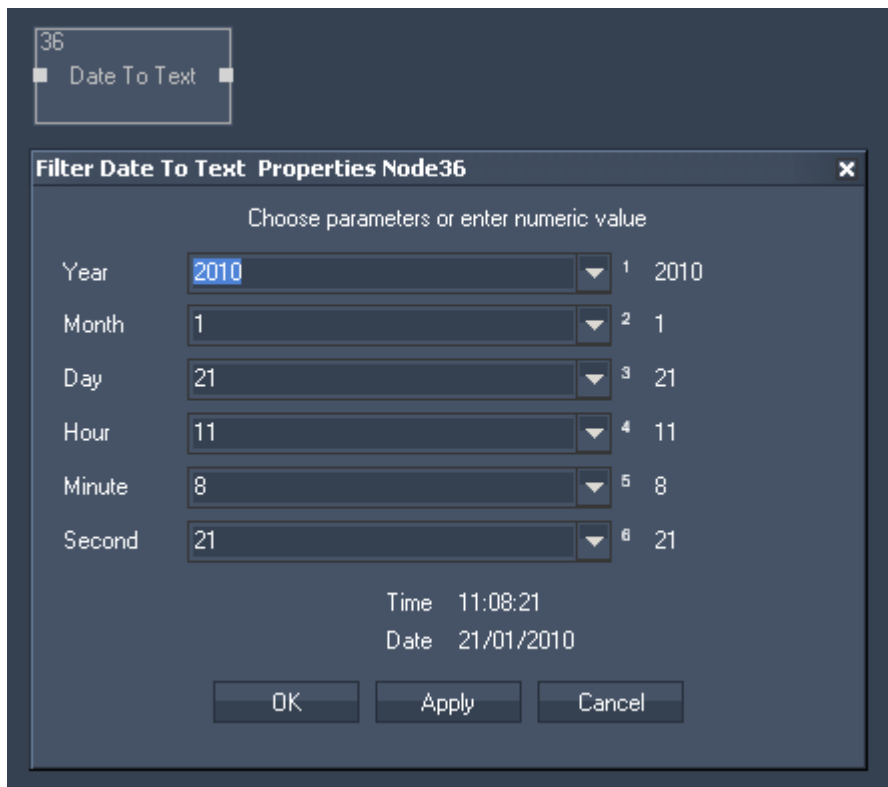

Filter Properties:

Year:

Choose input node from list or enter numeric value.

Month:

Choose input node from list or enter numeric value.

Day:

Choose input node from list or enter numeric value.

Hour:

Choose input node from list or enter numeric value.

Minute:

Choose input node from list or enter numeric value.

Second:

Choose input node from list or enter numeric value.

The filter generates the following output:

- Time Text Output
- Date Text Output

### 17.4.6.15.4 LEADING ZEROS

Generates Leading Zeros for Text. This is especially useful for scoreboard counts

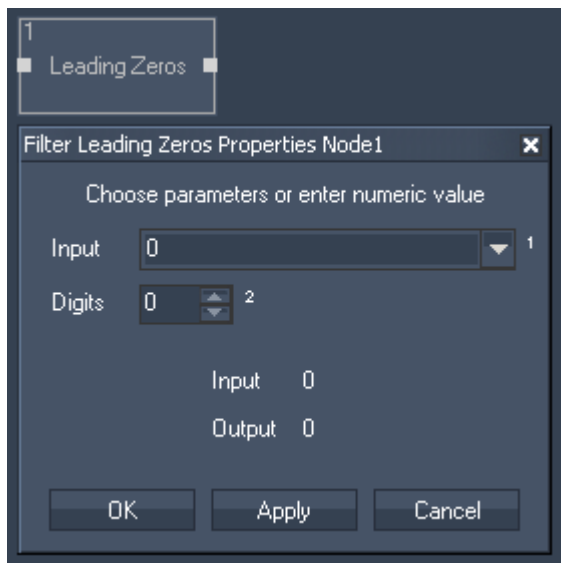

Filter Properties:

Input:

Choose input node from list or enter numeric value.

Digits:

Enter the amount of digits the filter should generate in front of the input.

The filter generates the following output:

- Leading Zeros Number

### 17.4.6.15.5 REGEX TEXT

The RegEx Text Filter node extends the "Find and Replace" feature known from common text editor software with RegEx expressions. A Regular Expression (short: RegEx) is a pattern that describes a certain combination / amount of text including word, number and (non-) printable characters. By supporting character classes (wild cards), grouping, back-references, etc. the RegEx engine allows very flexible and efficient text processing.

There are different RegEx flavors i.e. implementations in various programming languages. Widget Designer uses the RegEx the .NET framework library.

Below you will find a few examples how regular expressions work. For further information and complete description of supported character classes, operators and constructs, please visit:

<https://msdn.microsoft.com/en-us/library/az24scfc%28v=vs.110%29.aspx>

Note: The Filter node "[RegEx Compare](#)<sup>1105</sup>" also searches for text that matches the used RegEx but does not replace it, it simply returns a TRUE or FALSE.

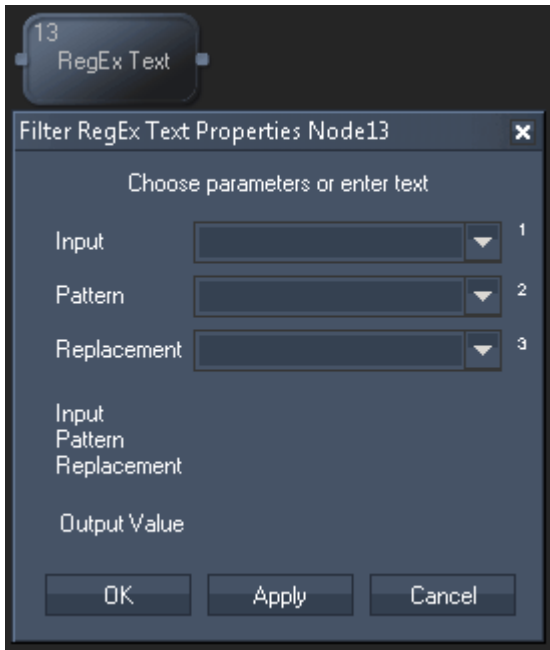

**Node properties**

**Input:**

Choose an input node from the list or enter a string.

**Pattern:**

Enter a regular expression describing the text you like to search for.

**Replacement:**

Enter a regular expression that should replace a found pattern.

**Node output values**

The node generates the following outputs:

- Output

**Examples for Regular Expressions**

These examples are based on the input string:

A cat wears 99 hats - What? - Yes, yes!

Pattern	Replace	Output	Meaning
[a-z]+	1	A 1 1 99 1 - W1? - Y1, 1!	Searches case-sensitive any letter from character group "a-z" that occurs at least once. Replaces with digit "1"!
(cat)[^?]*	\$1	A cat? - Yes, yes!	Searches for the word "cat" followed by any character that is not a "?" occurring zero or more times. By putting "cat" in round brackets, it became group no.1. Replaces with first group.
[^a-zA-Z0-9 ]		A cat wears 22 hats	Searches for any character that is not a-z nor A-Z nor 0-9 nor a space. Replaces with nothing. The mentioned characters can be described shorter with the "character class" word character "w". Hence, we can search alternatively for the negated group.
[\w]		What Yes yes	
\W			
(?i)yes	yes	A cat wears 22 hats - What? - yes, yes!	Searches case-insensitive for the word "yes". Replaces with "yes".



For further information and complete description please visit:  
<https://msdn.microsoft.com/en-us/library/az24scfc%28v=vs.110%29.aspx>

### 17.4.6.15.6 REGEX COMPARE

The RegEx Text Filter node extends the "Find" feature known from common text editor software with RegEx expressions. A Regular Expression (short: RegEx) is a pattern that describes a certain combination / amount of text including word, number and (non-) printable characters. By supporting character classes (wild cards), grouping, back-references, etc. the RegEx engine allows very flexible and efficient text processing.

There are different RegEx flavors i.e. implementations in various programming languages. Widget Designer uses the RegEx the .NET framework library.

Note: The Filter node "[RegEx Text](#)<sup>1103</sup>" also searches for text that matches the used RegEx, but in addition to the "RegExCompare" node it can also replace it. In the chapter for "[RegEx Text](#)<sup>1103</sup>" node you will find a few examples how regular expressions work. For further information and complete description of supported character classes, operators and constructs, please visit:  
<https://msdn.microsoft.com/en-us/library/az24scfc%28v=vs.110%29.aspx>

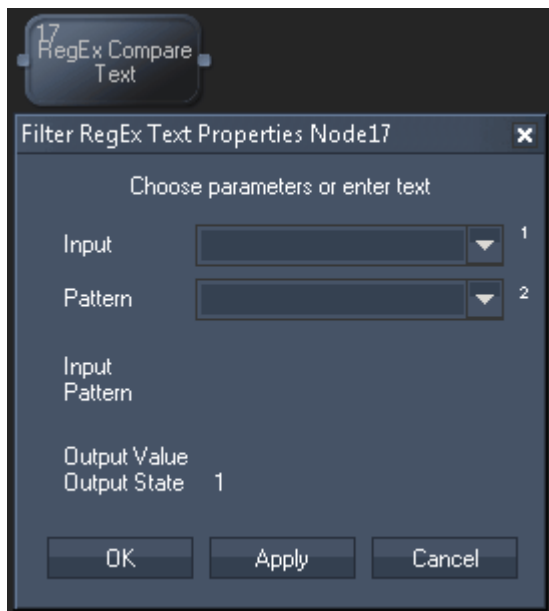

#### Node properties

**Input:**

Choose an input node from the list or enter a string.

**Pattern:**

Enter a regular expression describing the text you like to search for.

#### Node output values

The node generates the following outputs:

- Output
- State

### 17.4.6.15.7 TEXT COMBINER

Combines up to eight text input sources or entered text to one string.  
 The Text Combine Filter now supports single entry for Line Feed [LF].

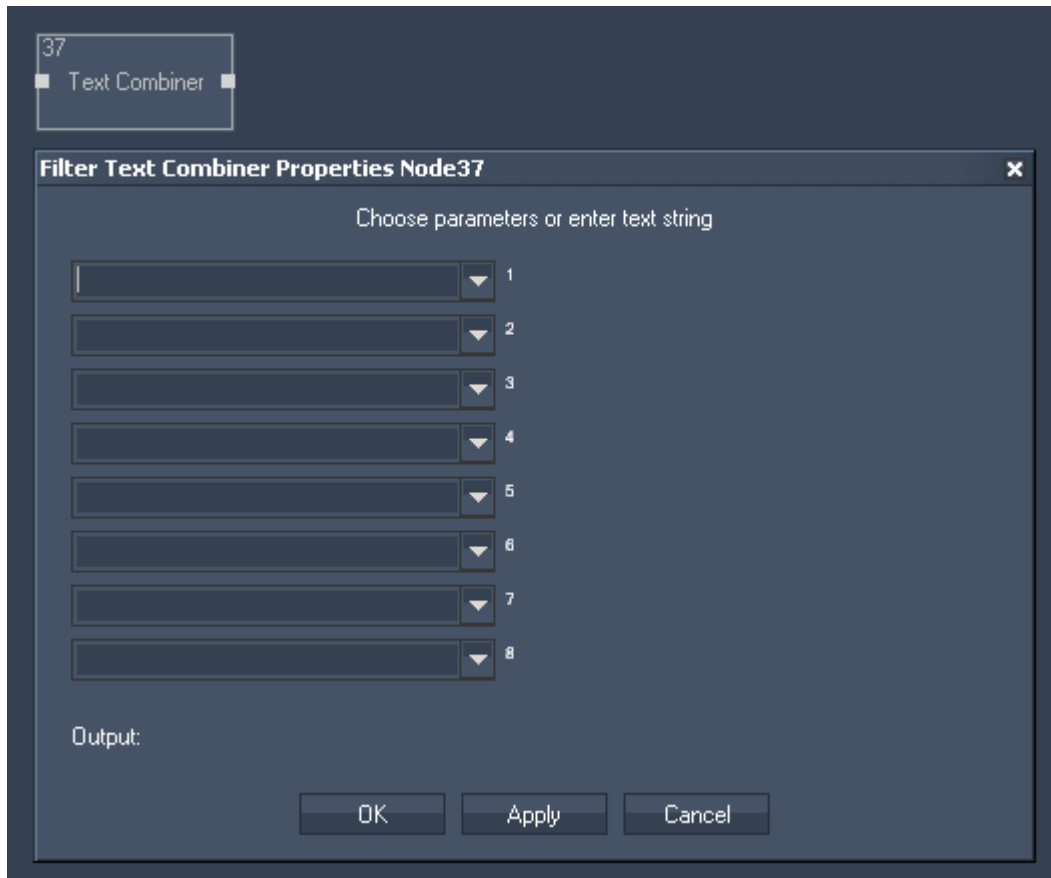

Filter Properties:

Inputs (8x):

Choose input node from list or enter text string.

The filter generates the following output:

- Time String Output

### 17.4.7 OUTPUT NODES

Output nodes are used to send values out that are provided by other nodes. Please see the introductory chapter if you like to learn more about other node types or [how to create and work with nodes](#)<sup>964</sup> in general.

#### [ANGULAR DISPLAY](#)<sup>1109</sup>

The Angular Display output node allows routing any incoming numeric value to be displayed on an Angular Display.

#### [ART-NET](#)<sup>1110</sup>

The Art-Net output node allows assigning incoming source values to either an 8 or 16bit DMX output value on a given Art-Net Subnet and Universe.

[BAR GRAPH](#)<sup>1111</sup>

The Bar Graph output node allows assigning incoming source values to a Bar Graph.

[COM PORT MESSAGE](#)<sup>1112</sup>

The Com Port Message value acts like an if node, the incoming data can be compared and depending on the true or false result a dedicated ASCII or Byte packet can be sent to the local COM Port.

[COM PORT ASCII STREAM](#)<sup>1113</sup>

The Com ASCII Stream output node allows sending ASCII values over the local COM Port connection.

[DIGITAL DISPLAY](#)<sup>1114</sup>

The Digital Display output node allows assigning incoming source values to a digital Display.

[DMX LINK OUT](#)<sup>1114</sup>

The DMX Link output node allows to send out DMX data via the coolux DMX Link Out interface (interface is still in development).

[EXCEL WRITER](#)<sup>1115</sup>

The Excel Writer output node allows to write incoming data to Excel sheets.

[FADER](#)<sup>1116</sup>

The Fader output value allows to remote control any fader based on its ID within Widget Designer project.

[LABEL](#)<sup>1116</sup>

The Label output value allows to display any input value to a label inside the Widget Designer.

[MIDI NOTE ON/OFF](#)<sup>1117</sup>

The Midi Note On/Off node allows to send Midi Note on/off values to a given note on a given Midi Channel.

[MIDI RAW MESSAGE](#)<sup>1118</sup>

The Midi Raw Message node allows mapping individual input source values to all 5 midi control bytes.

[MIDI VALUE](#)<sup>1119</sup>

The Midi Value output node allows sending a 7 or 15bit value on a given Midi Channel.

[MOUSE](#)<sup>1120</sup>

The Mouse output node allows to remote control the local mouse and map input values to emulate mouse clicks and mouse motion.

[PAGE](#)<sup>1121</sup>

The Page output node allows executing a page change inside WD via an input source.

[PB DEVICE CONTROL](#)<sup>1122</sup>

The Device node allows controlling any Pandoras Box Device with any parameter name in both, absolute or relative mode.

[PB SEQUENCE CONTROL](#)<sup>1123</sup>

The Sequence Control output node allows mapping any input or filtering data to any sequence parameter value.

[PB SEQUENCE SEEK](#)<sup>1124</sup>

The Sequence Seek output node allows mapping any input or filtering data in order to set any sequence to any timecode.

[PB TEXT](#)<sup>1125</sup>

The PB Text output node allows routing any input or filtering data to a PB Text Asset.

### [PB TEXT UNICODE](#)<sup>1126</sup>

The PB Text Unicode output node allows sending text strings in any language format to Pandoras Box text assets.

### [SCRIPT](#)<sup>1129</sup>

The Script output node acts like an if node, the incoming data can be compared and depending on the true or false result a dedicated script can be executed within Widget Designer. It is recommended for performance reasons to choose "Update on input value change only".

### [SERIAL LINK](#)<sup>1131</sup>

The Serial Link output node connects to a serial link via the connection managers TCP ID. Incoming values can be compared to send ASCII or Byte packets to any of the four serial ports of the connected Serial Link. All 24 GPI contact closures can be mapped and assigned to input values as well 0 is off, 1 is contact closed. It is recommended for performance reasons to choose "Update on input value change only".

### [TCP MESSAGE](#)<sup>1133</sup>

The TCP Message value acts like an if node. The incoming data can be compared and depending on the true or false result a dedicated ASCII or Byte packet can be sent to the TCP connection setup by its ID in the Connection Manager.

### [TCP ASCII STREAM](#)<sup>1134</sup>

The TCP ASCII Stream output node allows sending ASCII values over the local COM Port connection.

### [TEXTBOX](#)<sup>1135</sup>

The Textbox output node allows sending incoming texts to a text box within Widget Designer.

### [UDP MESSAGE](#)<sup>1136</sup>

The UDP Message value acts like an if node. The incoming data can be compared and depending on the true or false result a dedicated ASCII or Byte packet can be sent to the UDP connection setup by its ID in the Connection Manager.

### [UDP ASCII STREAM](#)<sup>1137</sup>

The UDP ASCII Stream output node allows to send ASCII values over an UDP connection.

### [VALUE](#)<sup>1138</sup>

The Value output node allows to easily change the value of a [Value input node](#)<sup>1067</sup>.

### [VARIABLE](#)<sup>1138</sup>

The Variable output node allows assigning new values to an existing Variable.

### [VIDEO PLAYER TIME](#)<sup>1139</sup>

The Video Player Time output node allows controlling the current time of an video played in the [Video Player](#)<sup>956</sup> that is integrated within Widget Designer.

### [VIDEO PLAYER VOLUME](#)<sup>1140</sup>

The Video Player Volume output node allows controlling the Volume of the Video Player integrated within Widget Designer.

### 17.4.7.1 ANGULAR DISPLAY

The Angular Display output node allows routing any incoming numeric value to be displayed on an Angular Display.

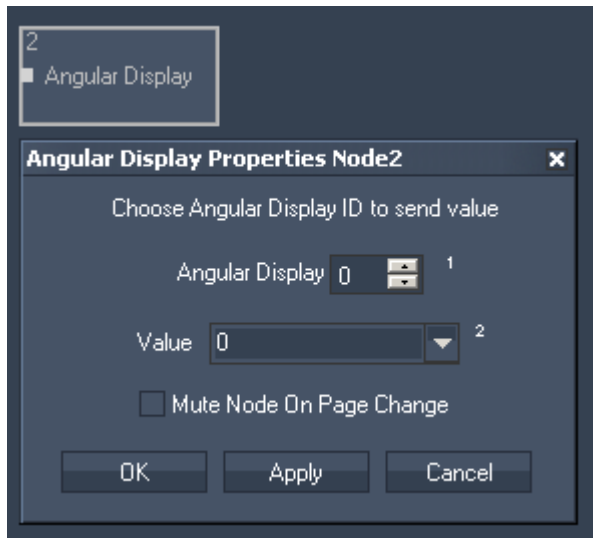

Node Properties:

Angular Display:

Please enter the ID of the Angular Display.

Value:

Please choose the input source that should be given out via this Angular Display.

Tick the check box to Mute Node on Page Change.

### 17.4.7.2 ART-NET

The Art-Net output node allows to assign incoming source values to multiple 8 or 16bit DMX output Channels on a given Art-Net Subnet and Universe.

Simply type in all DMX start addresses and use a white space in between them i.e.: 1 2 123.

The Art-Net output node updates Art-Net only on change of the input value.

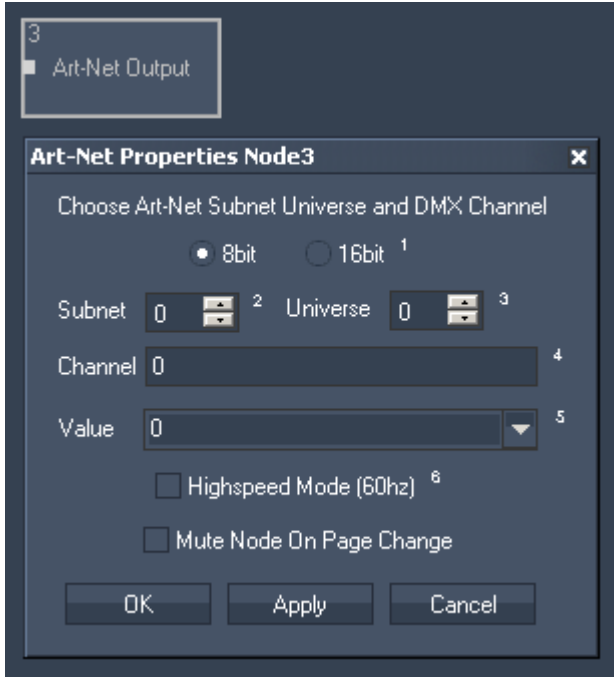

Node Properties:

Tick one of the check boxes to give out either 8bit or 16 bit DMX values.

Art-Net Subnet, Universe:

Set here the Art-Net Subnet and Universe.

Channel:

Set here the DMX channel. To send Art-Net to multiple channels, use a white space in between the channel IDs, e.g. 1 2 509.

Value:

Please choose one of your incoming source values.

Highspeed Mode (60 Hz):

Enable this option to use the Highspeed Mode that does a refresh rate of 60 Hz (Default is off)

Please note:

The Highspeed Mode is not supported by GrandMA consoles.

Tick the check box to Mute Node on Page Change.

### 17.4.7.3 BAR GRAPH

The Bar Graph output node allows assigning incoming source values to a [Bar Graph](#)<sup>914</sup>.

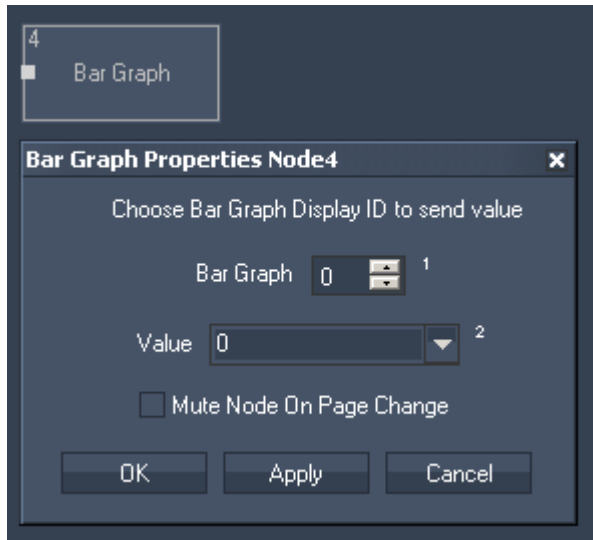

Node Properties:

Bar Graph:  
Please enter the ID of the Bar Graph.

Value:  
Please choose the input source that should be given out via this Bar Graph.

Tick the check box to Mute Node on Page Change.

### 17.4.7.4 COM PORT MESSAGE

The Com Port Message value acts like an if node, the incoming data can be compared and depending on the true or false result a dedicated ASCII or Byte packet can be sent to the local COM Port. Set up its ID in the [Connection Manager](#)<sup>[1166]</sup>.

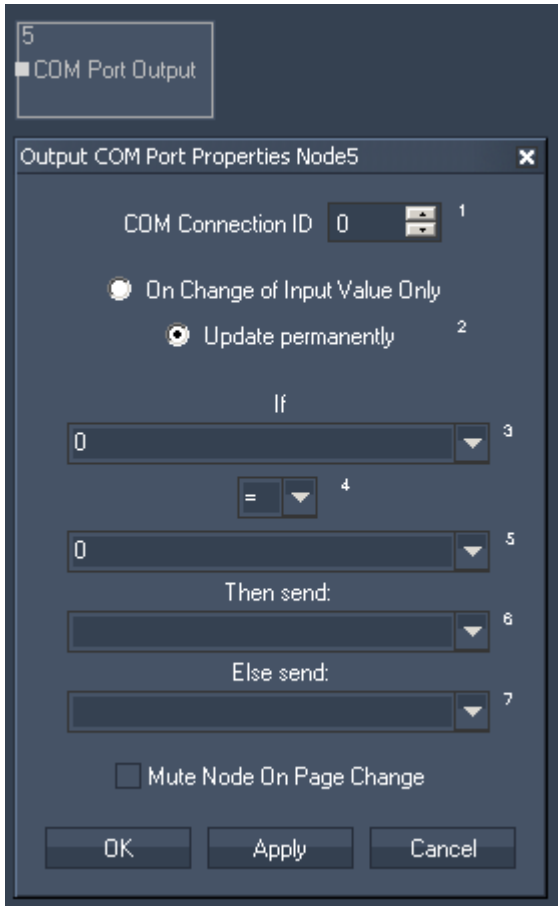

Node Properties:

COM Connection ID:  
Enter the COM Port Connection ID.

Update:  
Choose if the output should be updated either "On Change of Input Value Only" or permanently.

If:  
Choose the first input node from list or enter numeric value. This input will be compared to the second input.  
Choose the Operator.  
Choose the second input node from list or enter numeric value.

Then send:  
If the operation is True, this input node value or entered numeric value will be given out as Output Value.

Else send:  
If the operation is False, this input node value or entered numeric value will be given out as Output Value.

Tick the check box to Mute Node on Page Change.



### 17.4.7.5 COM PORT ASCII STREAM

The Com Port ASCII Stream output node allows sending ASCII values over the local COM Port connection.

Set up the COM Port Connection in the [Connection Manager](#)<sup>1166</sup>.

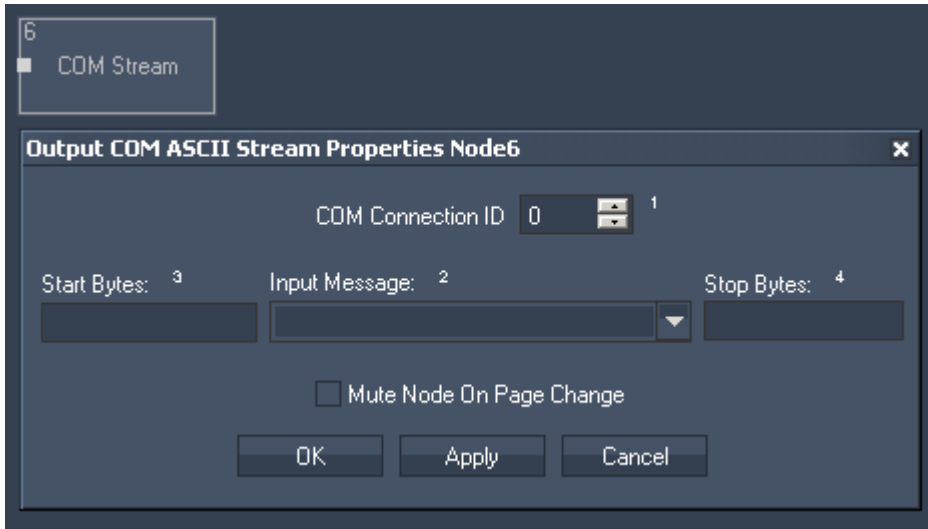

Node Properties:

COM Connection ID:

Enter the COM Port Connection ID.

Start and Stop Bytes:

Enter Start and Stop Bytes that should frame the message.

Enter these values as string, dec or hex value. Please refer to [Syntax TCP- / UDP- / Serial messages](#)<sup>970</sup>.

Input Message:

Please choose the input source that should be given out via this COM Port Output Node.

Tick the check box to Mute Node on Page Change.

### 17.4.7.6 DIGITAL DISPLAY

The Digital Display output node allows assigning incoming source values to a [Digital Display](#)<sup>915</sup>.

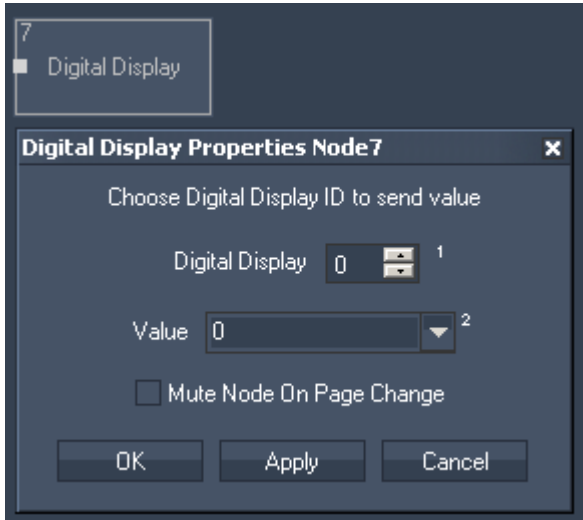

Node Properties:

Digital Display:

Please enter the ID of the Digital Display.

Value:

Please choose the input source that should be given out via this Bar Graph.

Tick the check box to Mute Node on Page Change.

### 17.4.7.7 DMX LINK OUT

The DMX Link output node allows sending out DMX data via the coolux DMX Link Out interface (interface is still in development).

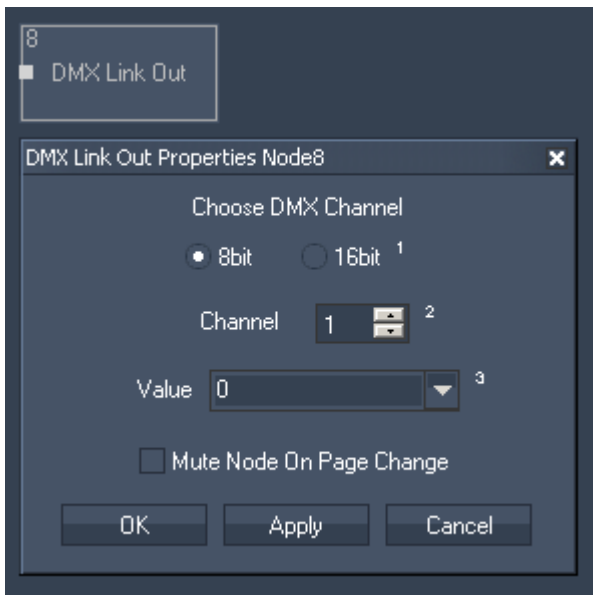

Node Properties:

**DMX Channel:**

Choose the channel and if it is an 8bit or 16bit value.

**Value:**

Please choose the input source that should be given out via this DMX Link Output Node.

Tick the check box to Mute Node on Page Change.

**17.4.7.8 EXCEL WRITER**

The Excel Writer output node allows writing incoming data to Excel sheets.

Please note that as long the output node is active you won't be able to open the file in Excel at the same time.

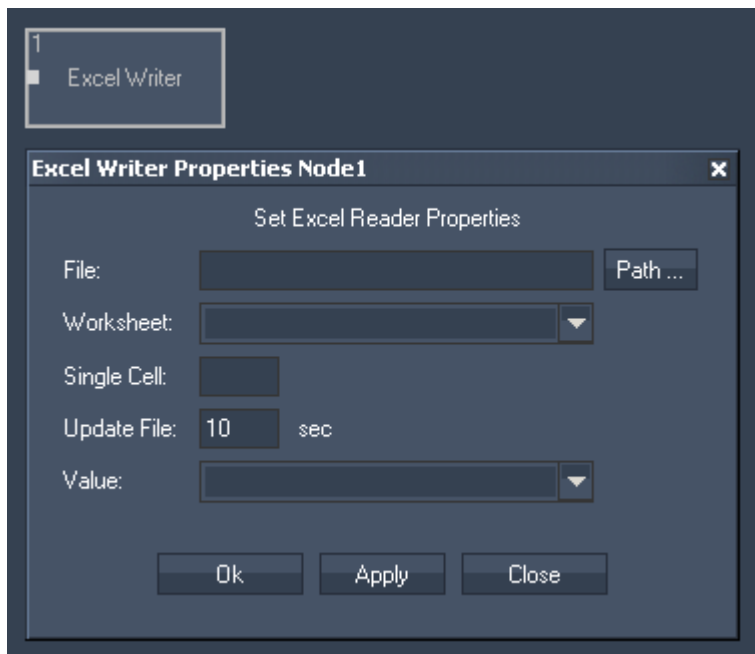

**Node Properties:**

**File:**

Click on [Path] to browse to the Excel file to which the node should write the incoming data. Press [Apply] in order to choose the File.

**Worksheet:**

Please choose the worksheet from the list that should be edited. Press [Apply] in order to choose the Worksheet.

**Single Cell:**

Enter the cell in which the node should write the incoming data, for example A1.

**Update File:**

By default the Excel File will be updated every 10 seconds. You may increase or decrease this value here.

**Value:**

Please choose the input source that should be written into the specified document.

### 17.4.7.9 FADER

The Fader output value allows to remote control any fader based on its ID within Widget Designer project.

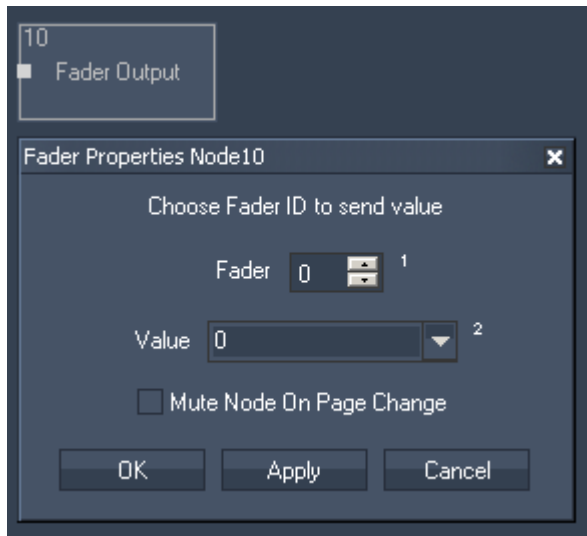

Node Properties:

Fader:

Please enter the ID of the Fader.

Value:

Choose the input source that should remote control the fader.

Tick the check box to Mute Node on Page Change.

### 17.4.7.10 LABEL

The Label output value allows displaying any input value to a label inside the Widget Designer.

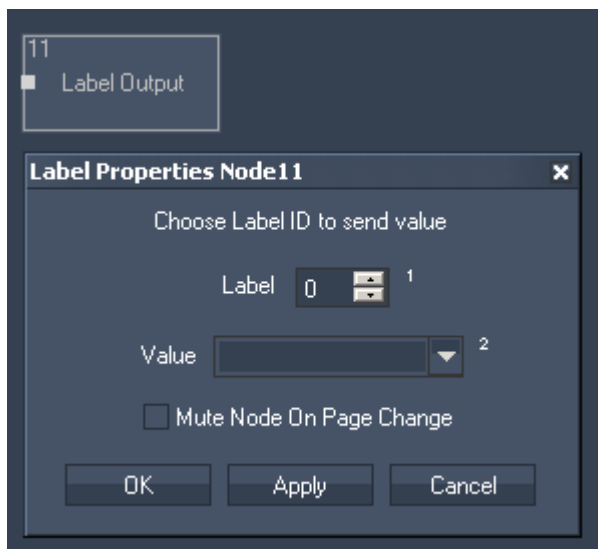

Node Properties:

Fader:  
Please choose the Label ID.

Value:  
Please choose the input source that should be displayed to the label.

Tick the check box to Mute Node on Page Change.

### 17.4.7.11 MIDI NOTE ON/OFF

The Midi Note On/Off node allows to send Midi Note on/off values to a given note on a given Midi Channel.

The Midi connection needs to be enabled in the [Connection Manager](#)<sup>1166</sup>.

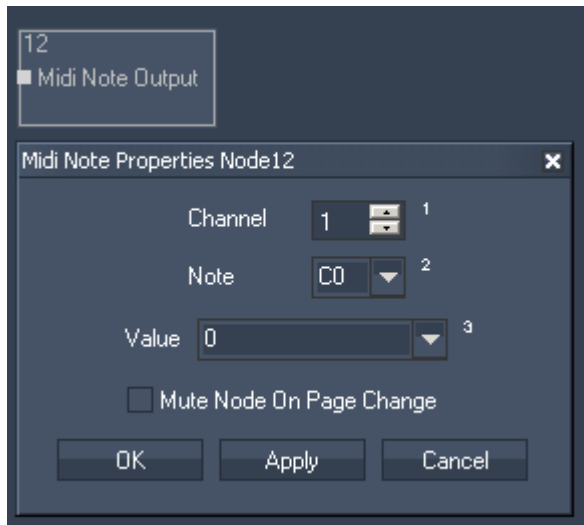

Node Properties:

Channel:  
Please choose the Midi Channel.

Note:  
Please choose the Midi Note.

Value:  
Please choose the input source. Its values will be sent as Midi Note on/off values.

Tick the check box to Mute Node on Page Change.

### 17.4.7.12 MIDI RAW MESSAGE

The Midi Raw Message node allows mapping individual input source values to all 5 midi control bytes. The Midi connection needs to be enabled in the [Connection Manager](#)<sup>1166</sup>.

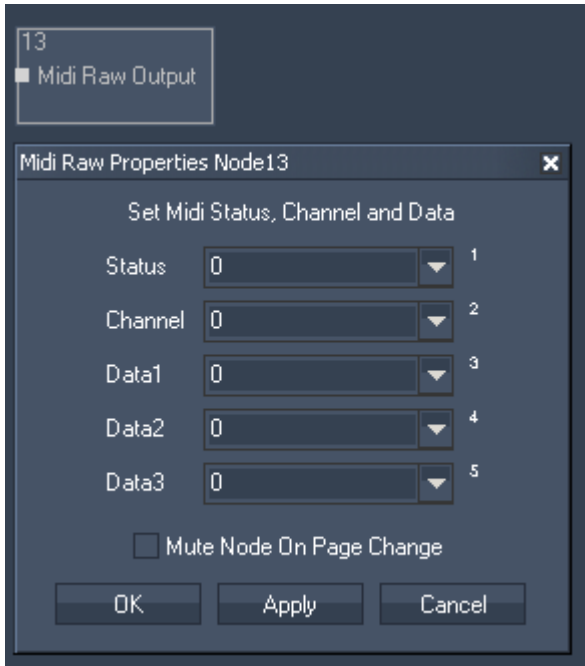

Node Properties:

Status:

Choose an input source from the list or enter a numeric value.

Channel:

Choose an input source from the list or enter a numeric value.

Data1:

Choose an input source from the list or enter a numeric value.

Data2:

Choose an input source from the list or enter a numeric value.

Data3:

Choose an input source from the list or enter a numeric value.

Tick the check box to Mute Node on Page Change.

### 17.4.7.13 MIDI VALUE

The Midi Value output node allows sending a 7 or 15bit value on a given Midi Channel. The Midi connection needs to be enabled in the [Connection Manager](#)<sup>1166</sup>.

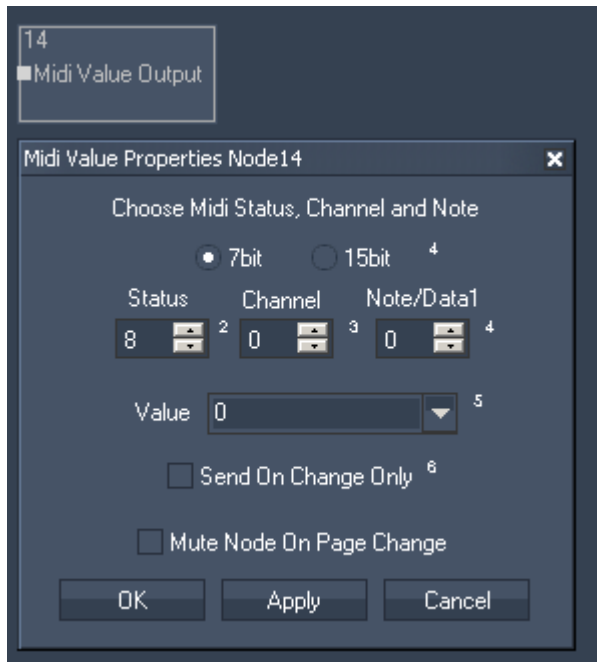

Node Properties:

Please choose if you want to send a 7 or 15bit value.

Status:

Enter the Midi Status.

Channel:

Enter the Midi Channel.

Note/Data1:

Enter the Midi Note / Data1.

Value:

Choose the Input Source from the list to send on this Midi Channel.

Tick the first check box to Send on change Only.

Tick the second check box to Mute Node on Page Change.

### 17.4.7.14 MOUSE

The Mouse output node allows to remote control the local mouse and map input values to emulate mouse clicks and mouse motion.

New feature from WD Rev 130 on: the Mouse Output Node only moves the mouse when input value has changed.

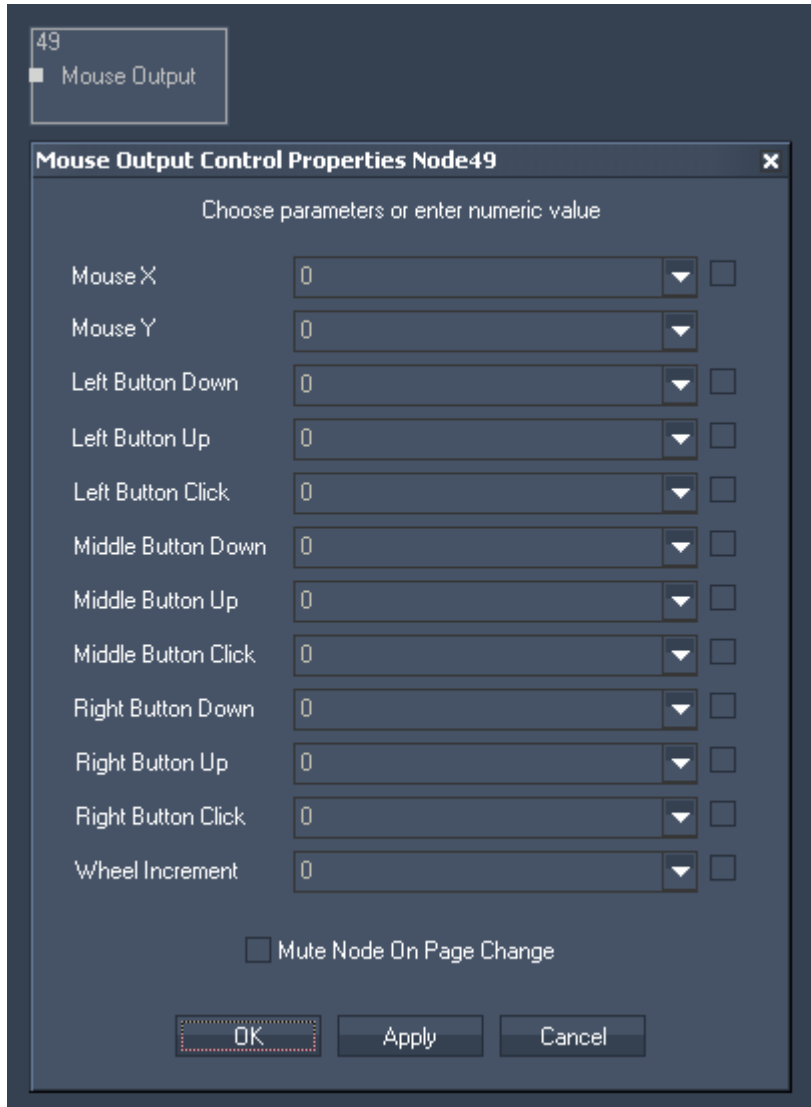

Node Properties:

Enable the parameter of your local mouse that you want to remote control by ticking its check box.

Please note:

The values for Mouse X and Mouse Y range from 0 to the max. value of your screen resolution.

The values for all other parameters have to be either 0 (False) or 1 (True).

Tick the check box to Mute Node on Page Change.



### 17.4.7.15 PAGE

The Page output node allows executing a page change inside WD via an input source. Please note that the input coming from another node needs to be written exactly like the page name you want to change to (case sensitive)!

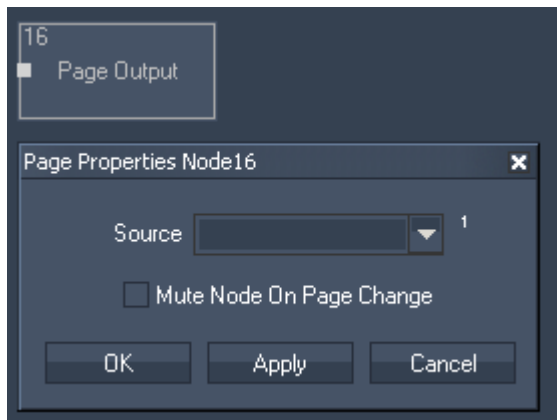

Node Properties:

Source:

Choose the input source from the list that should provide the page names.

Tick the check box to Mute Node on Page Change.

### 17.4.7.16 PB DEVICE CONTROL

The Device node allows controlling any Pandoras Box Device with any parameter name in both, absolute or relative mode.

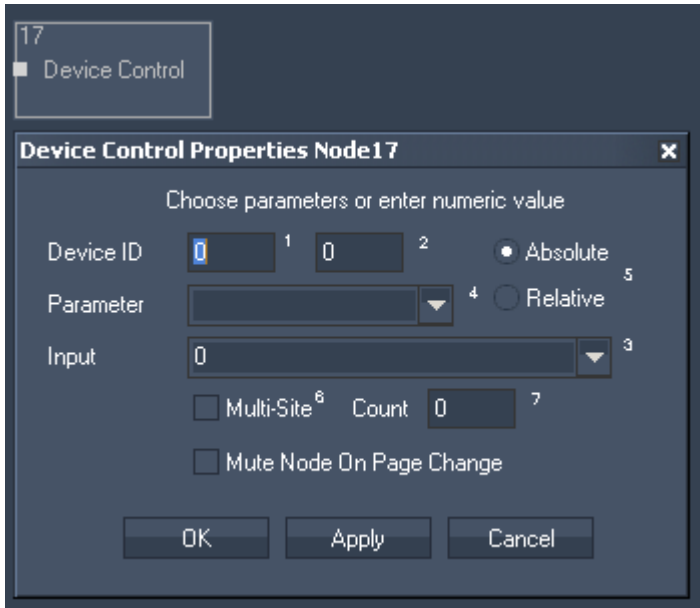

Node Properties:

Device ID:

Enter the Device ID, e.g. 1 in the first text field and 2 in the second text field. This will control Layer 2 of Site 1.

Absolute / Relative:

Choose absolute or relative mode. In absolute mode the PB device will take the input value, in relative mode the input value will be added or subtracted to the PB device parameter's value.

Parameter:

Choose the parameter you want to control from the list.

Input:

Choose the input source from the list that should provide the values.

Multi-Site:

In order to control several devices simultaneously the Multi-Site option can be used instead of adding a second PB Device Control Output Node. To do so please tick the check box and enter the amount of sites.

Example:

To control Layer 1 of Site 1 and Layer 1 of Site 2, enter "1" "1" in the text fields for the Device ID.

Enable the Multi-Site option and enter the amount of sites: "2".

To control Layer 1 of Site 2 and Layer 1 of Site 3, enter "2" "1" in the text fields for the Device ID and "2" for the Multi-Site Count.

Tick the check box to Mute Node on Page Change.

### 17.4.7.17 PB SEQUENCE CONTROL

The Sequence Control output node allows mapping any input or filter node data to any sequence parameter value.

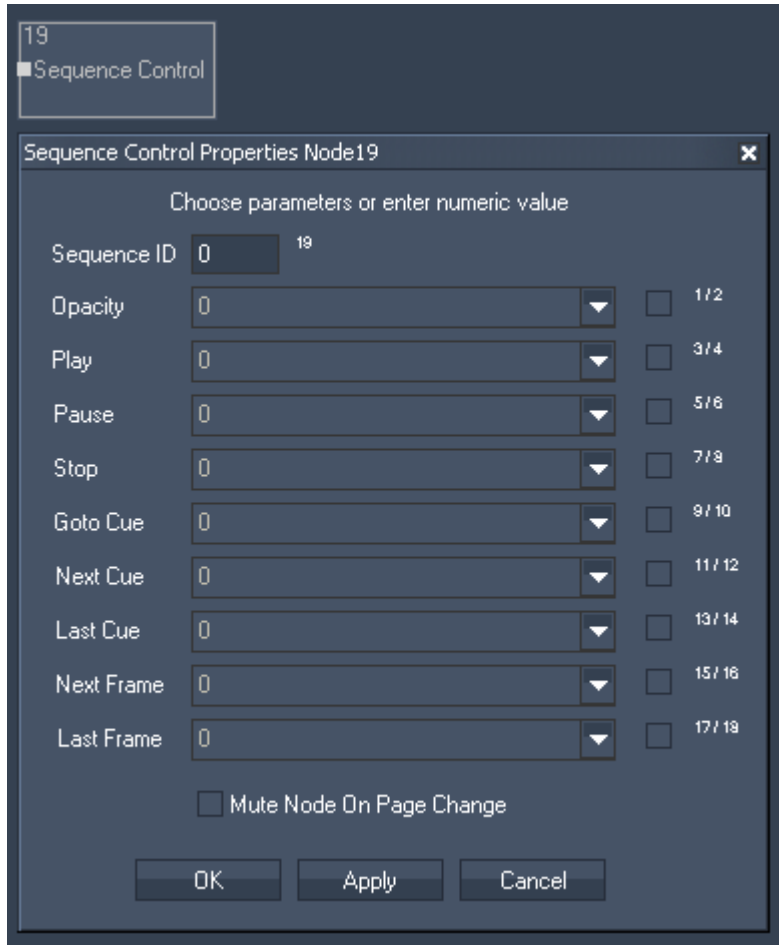

Node Properties:

Sequence ID:  
Enter the Sequence ID.

Parameter:  
Enable all parameters you want to control by ticking its check box. Choose the input source for the parameter from the list.

The parameters accept different value ranges:

Opacity	0 to 255
Play, Pause, Stop	0=false, 1=true
GotoCue	Cue ID
Next/Last Cue and Next / Last Frame	0=false, 1=true

Tick the check box to Mute Node on Page Change.

### 17.4.7.18 PB SEQUENCE SEEK

The Sequence Seek output node allows mapping any input or filter node data in order to set any sequence to any timecode.

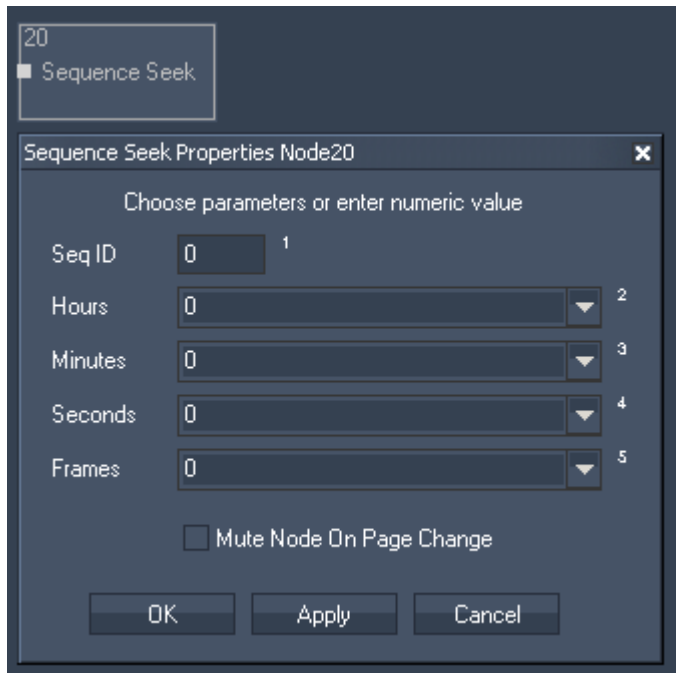

Node Properties:

Sequence ID:  
Enter the Sequence ID.

Hours:  
Choose the input source from the list.

Minutes:  
Choose the input source from the list.

Seconds:  
Choose the input source from the list.

Frames:  
Choose the input source from the list.

Tick the check box to Mute Node on Page Change.

**17.4.7.19 PB TEXT**

The PB Text output node allows routing any input or filter node data to a PB Text Asset.

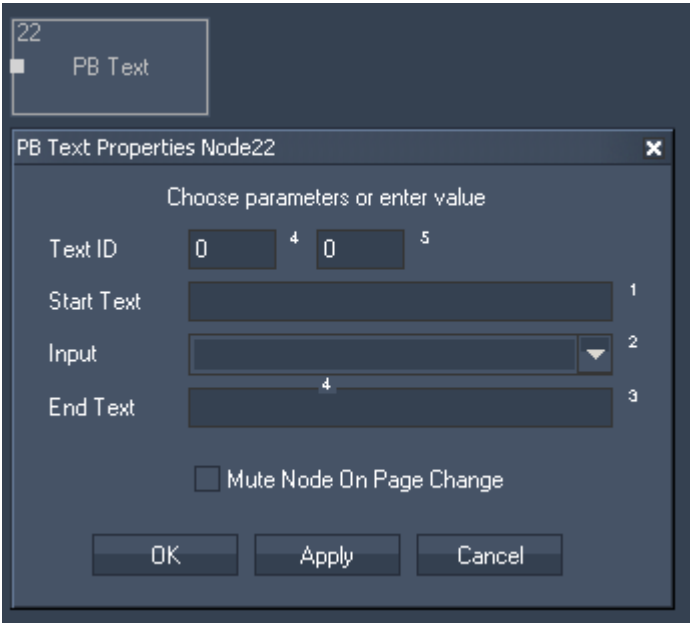

Node Properties:

**Text ID:**  
Enter the Text Asset's DMX File and Folder ID. Set up this Text ID in Pandoras Box.

**Start Text:**  
Enter any text the Text Asset should start with.

**Input:**  
Choose the input source from the list.

**End Text:**  
Enter any text the Text Asset should end with.

Tick the check box to Mute Node on Page Change.

### 17.4.7.20 PB TEXT UNICODE

The PB Text Unicode output node allows sending text strings in any language format to Pandoras Box text assets.

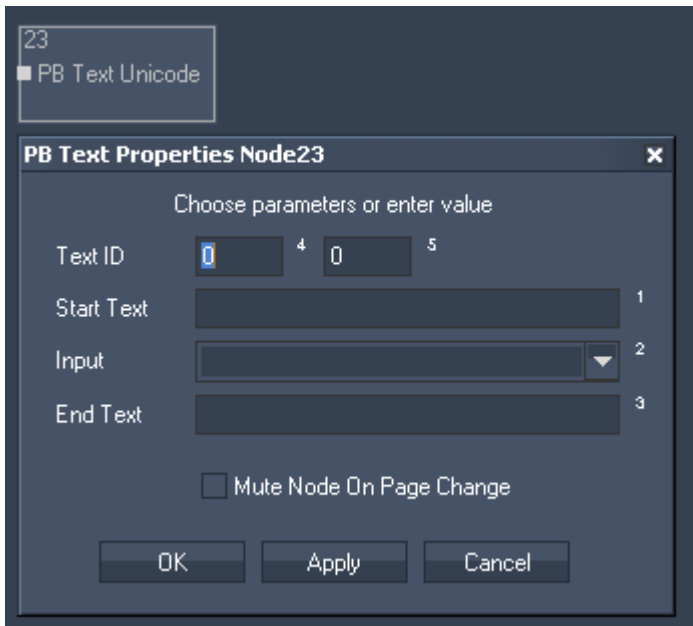

Node Properties:

Text ID:

Enter the Text Asset's DMX File and Folder ID. Set up this Text ID in Pandoras Box.

Start Text:

Enter any text the Text Asset should start with.

Input:

Choose the input source from the list.

End Text:

Enter any text the Text Asset should end with.

Tick the check box to Mute Node on Page Change.

### 17.4.7.21 RELAY OUTPUT LINK

The Relay Output Link node allows to communicate with the NET Link equipped with output boards. Please see more information in the chapter covering the [NET Link](#)<sup>747</sup>.

The node configures the device and sends commands to it, for instance to close a contact.

The [NET Link Input node](#)<sup>1040</sup> might also be of interest for you.

Create > Nodes > Output > Devices > Relay Output Link

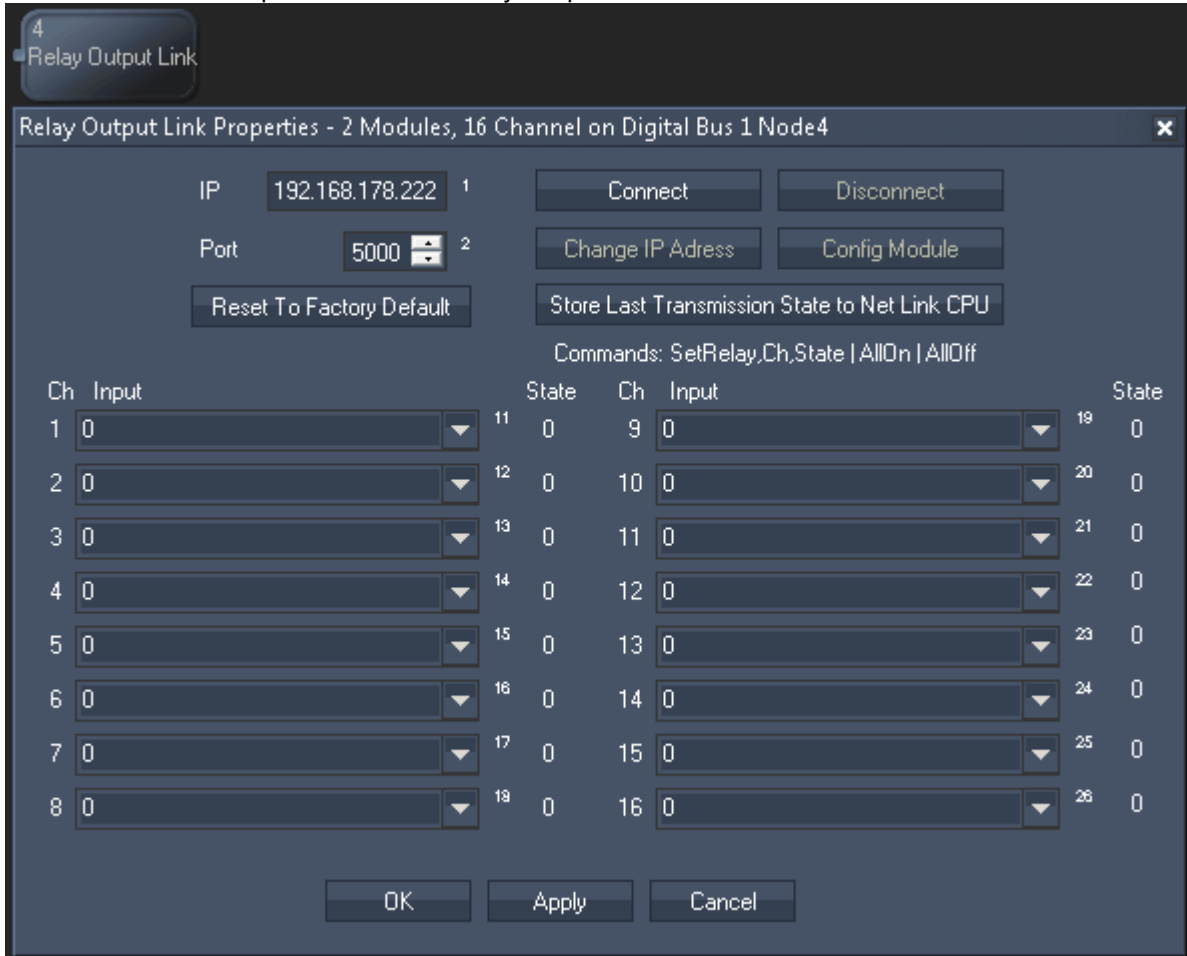

## Node properties

### IP and Port

Enter the correct IP address and port from the NET Link's processor or from the Calibration Link.

### Reset To Factory Default

This buttons resets the above settings in the Widget Designer interface. To reset the device itself (to the IP address 192.168.178.222 and the port to 5000), hold the "Reset" button down whilst plugging the power into the device. Release the button again.

### Connect / Disconnect

Before starting to communicate with the device, for instance receive data, the node must be connected to the device. The connection itself consumes no performance.

### Change IP Address

This button opens a new dialog whereto you may enter another IP address and port for the device. Power-cycle the device to apply the changes.

### Config Module

A NET Link / Calibration Link is configured by coolux as you have ordered it. However, if you have changed some input / output boards, the processor must be configured in terms of giving him the information which boards are connected to it. Click the "Config Module" button to open a new dialog where you may choose the according boards per processor connection. Find more details in the [NET Link hardware chapter](#)<sup>747</sup>.

---

### Start Data / Stop Data

As soon as data is processed via the network from the device to Widget Designer, performance is drawn.

### Store Last Transmission State to NET Link CPU

Click this button and power-cycle the device if you wish that it remembers whether it should (not) send data as soon as it is powered up.

### Channel, Input list and State

First, connect an Input node or Filter node to the Relay node to provide the information "0" or "1". Then open the Item Properties and choose the incoming source data for the channel you like to control. The "State" informs you about the current state of the what the incoming signal. "0" leaves the contact open, whilst "1" closes it.

### Node control

This node allows to be remote controlled via so called [node commands](#)<sup>977</sup>. Node commands access functions from a node and / or set a parameter.

Enter "node", followed by the according ID and a dot and a list will pop up showing all available commands for the node. For instance, `node1.StartData` will execute the function automatically without the need of opening the Item Properties dialog and clicking the according button manually. `node1.SetRelay,1,1` will set the first channel to the state "1".

In addition, the node properties with a parameter ID (the small superscript number) can be edited via the commands `WDNodeSetParam,NodeID,ParamID,Value` or `nodeID.ParamID@Value`.



### 17.4.7.22 SCRIPT

The Script output node acts like an If Node, the incoming data can be compared and depending on the true or false result a dedicated script can be executed within Widget Designer.

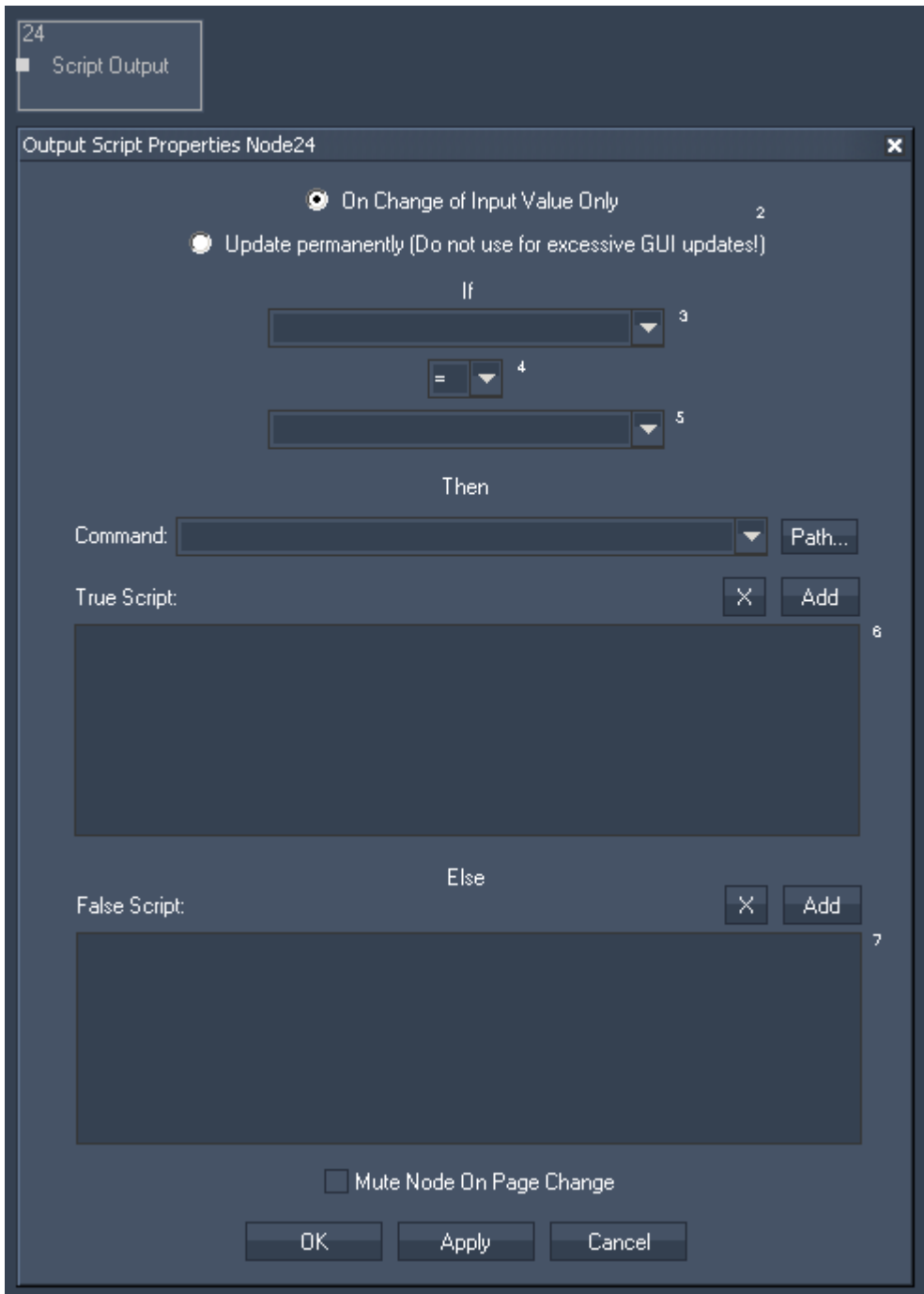

Node Properties:

Update:

Choose if the output should be updated either "On Change of Input Value Only" or permanently. It is recommended for performance reasons to choose "Update on input value change only".

---

If:

Choose the first input node from list or enter numeric value. This input will be compared to the second input.

Choose the Operator.

Choose the second input node from list or enter numeric value.

True and False Script:

In the Script sections you may enter commands to be executed. If the operation is true, the True script will be executed. If the operation is False, the False script will be executed.

To enter a command you may use the drop-down list and the "Add" button or type directly in the text field. The topic [Script Language](#)<sup>1254</sup> explains this in more detail.

See here a list of all [commands](#)<sup>1260</sup>.

Tick the check box to Mute Node on Page Change.

### 17.4.7.23 SERIAL LINK

The Serial Link output node connects to a serial link via the connection managers TCP ID. Incoming values can be compared to send ASCII or Byte packets to any of the four serial ports of the connected [Serial Link](#)<sup>729</sup>. All 24 GPI contact closures can be mapped and assigned to input values as well 0 is off, 1 is contact closed.



Node Properties:  
TCP Connection ID:

---

Enter the TCP Connection ID. The TCP Connections can be found and setup in the [Connection Manager](#)<sup>1166</sup>.

**Update:**

Choose if the output should be updated either "On Change of Input Value Only" or permanently. It is recommended for performance reasons to choose "Update on input value change only".

**If:**

Choose the first input node from list or enter numeric value. This input will be compared to the second input.

Choose the Operator.

Choose the second input node from list or enter numeric value.

**Then send:**

If the operation is True, the True script will be executed. You have the possibility to assign a different true send command for each Serial Link port. The topic [Script Language](#)<sup>1254</sup> explains commands and how to use them in more detail.

See here a list of all [commands](#)<sup>1260</sup>.

**Else send:**

If the operation is False, the Else script will be executed. You have the possibility to assign a different else send command for each Serial Link port.

**GPI Outputs:**

All 24 GPI contact closures can be mapped and assigned to input values as well 0 is off, 1 is contact closed.

Tick the check box to Mute Node on Page Change.

### 17.4.7.24 TCP MESSAGE

The TCP Message value acts like an If Node. The incoming data can be compared and depending on the true or false result a dedicated ASCII or Byte packet can be sent to the TCP connection setup by the its ID in the [Connection Manager](#)<sup>1166</sup>.

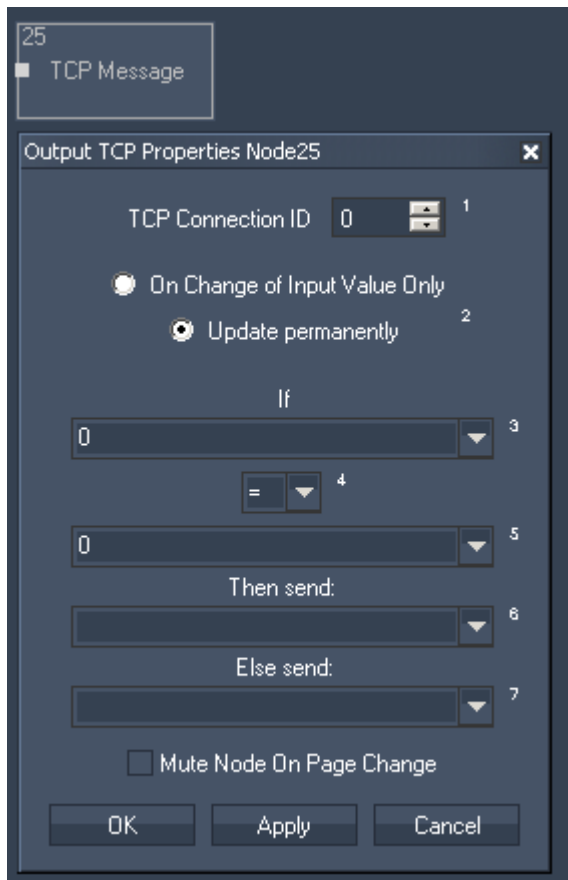

Node Properties:

TCP Connection ID:

Enter the TCP Connection ID.

Update:

Choose if the output should be updated either "On Change of Input Value Only" or permanently.

If:

Choose the first input node from list or enter numeric value. This input will be compared to the second input.

Choose the Operator.

Choose the second input node from list or enter numeric value.

Then send:

If the operation is True, this input node value or entered numeric value will be given out as Output Value.

Else send:

If the operation is False, this input node value or entered numeric value will be given out as Output Value.

Tick the check box to Mute Node on Page Change.

### 17.4.7.25 TCP ASCII STREAM

The TCP ASCII Stream output node allows sending ASCII values over a TCP connection. Set up the TCP Connection in the [Connection Manager](#)<sup>1166</sup>.

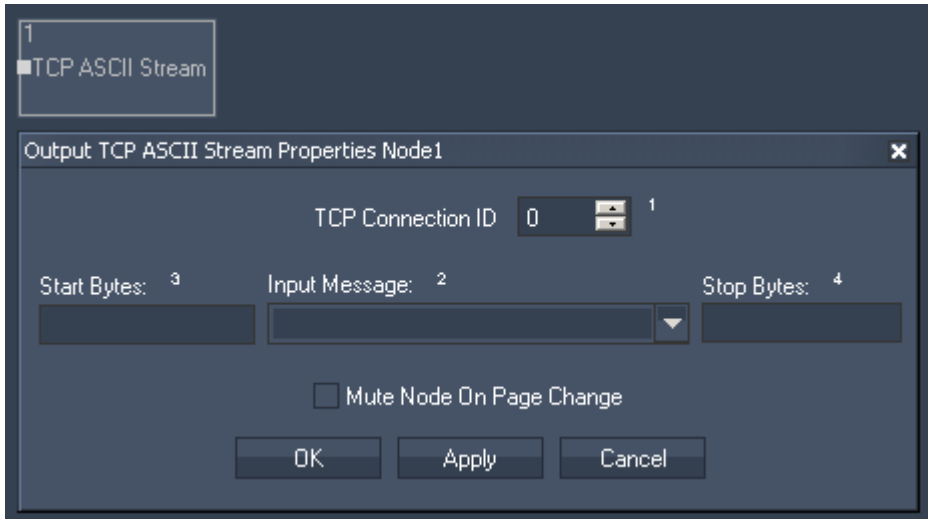

Node Properties:

TCP Connection ID:

Enter the TCP Connection ID.

Start and Stop Bytes:

Enter Start and Stop Bytes that should frame the message.

Enter these values as string, dec or hex value. Please refer to [Syntax TCP- / UDP- / Serial messages](#)<sup>970</sup>.

Input Message:

Please choose the input source that should be given out via this TCP Output Node.

Tick the check box to Mute Node on Page Change.

### 17.4.7.26 TEXTBOX

The Textbox output node allows sending incoming texts to a textbox within Widget Designer.

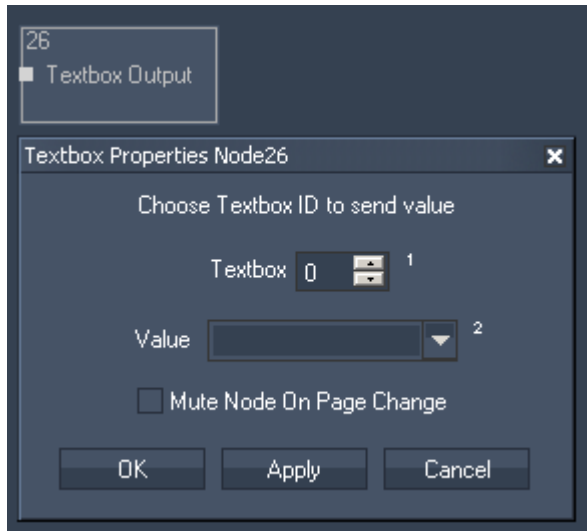

Node Properties:

Textbox ID:

Enter the Textbox ID the values should be sent to.

Value:

Please choose the input source.

Tick the check box to Mute Node on Page Change.

### 17.4.7.27 UDP MESSAGE

The UDP Message value acts like an If Node. The incoming data can be compared and depending on the true or false result a dedicated ASCII or Byte packet can be sent to the UDP connection setup by the its ID in the [Connection Manager](#)<sup>1166</sup>.

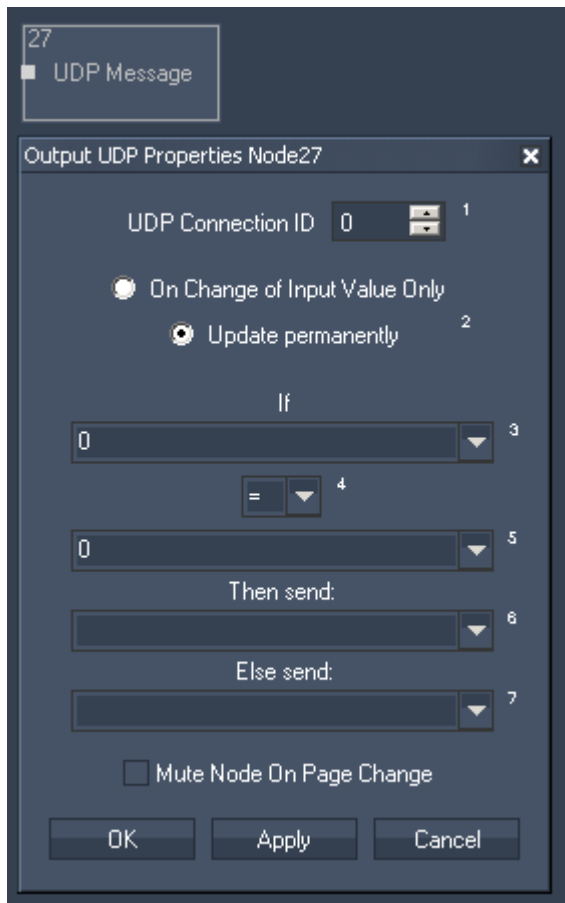

Node Properties:

UDP Connection ID:

Enter the UDP Connection ID.

Update:

Choose if the output should be updated either "On Change of Input Value Only" or permanently.

If:

Choose the first input node from list or enter numeric value. This input will be compared to the second input.

Choose the Operator.

Choose the second input node from list or enter numeric value.

Then send:

If the operation is True, this input node value or entered numeric value will be given out as Output Value.

Else send:

If the operation is False, this input node value or entered numeric value will be given out as Output Value.

Tick the check box to Mute Node on Page Change.



### 17.4.7.28 UDP ASCII STREAM

The UDP ASCII Stream output node allows sending ASCII values over an UDP connection.

Set up the UDP Connection in the [Connection Manager](#)<sup>1168</sup>.

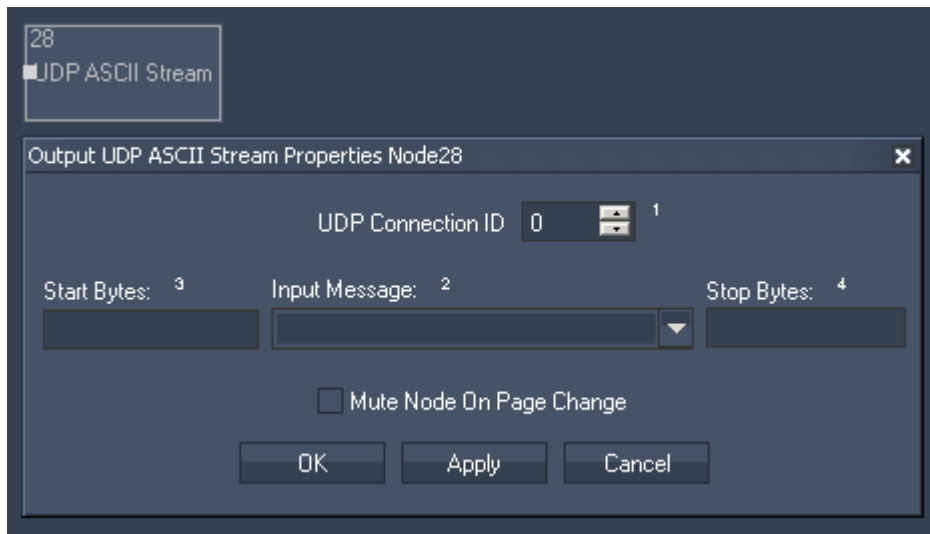

Node Properties:

TCP Connection ID:

Enter the UDP Connection ID.

Start and Stop Bytes:

Enter Start and Stop Bytes that should frame the message.

Enter these values as string, dec or hex value. Please refer to [Syntax TCP- / UDP- / Serial messages](#)<sup>970</sup>.

Input Message:

Please choose the input source that should be given out via this UDP Output Node.

Tick the check box to Mute Node on Page Change.

### 17.4.7.29 VALUE

The Value output node allows changing the value of a [Value input node](#)<sup>1067</sup>.

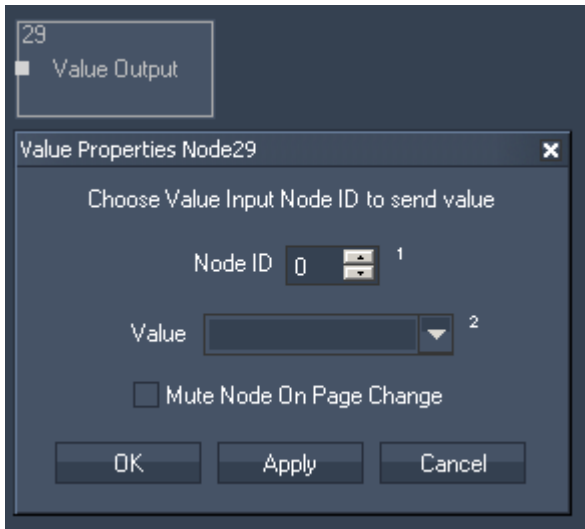

Node Properties:

Node ID:

Enter the ID of the Value Input Node whose value you want to change.

Value:

Choose the input source that should be routed to the specified Value Input Node.

Tick the check box to Mute Node on Page Change.

### 17.4.7.30 VARIABLE

The Variable output node allows assigning new values to an existing Variable.

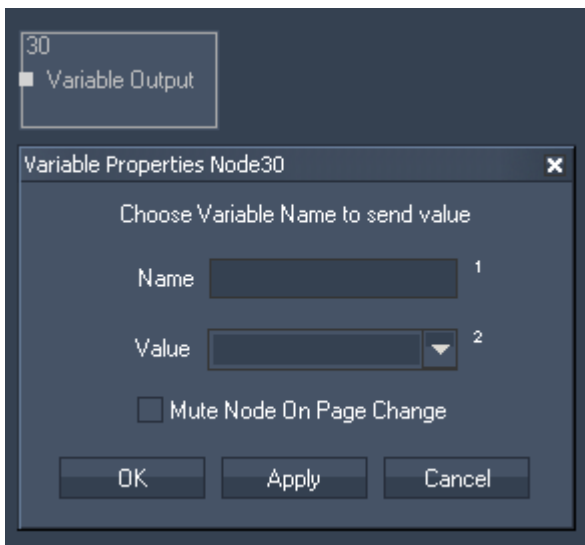

Node Properties:

Name:

Enter here the Variable's name.

Value:

Choose the input source that should be routed to the specified Variable.

Tick the check box to Mute Node on Page Change.

To set up and process variables, please use [these scripts](#)<sup>1385</sup>:

To see all existing variables and their values, see the [Variable List](#)<sup>1193</sup>.

### 17.4.7.31 VIDEO PLAYER TIME

The Video Player Time output node allows controlling the current time of a video played in the [Video Player](#)<sup>956</sup> that is integrated within Widget Designer.

The time is always handled in seconds.

Example:

To jump to the timecode 1min 25 seconds, the input source has to take the value 85 seconds.

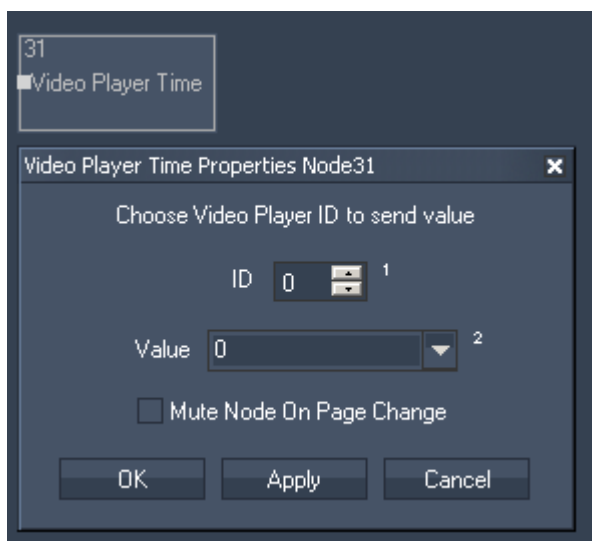

Node Properties:

Video Player ID:

Enter the Video Player ID.

Value:

Choose the input source that should remote control the Video Player Time.

Tick the check box to Mute Node on Page Change.

### 17.4.7.32 VIDEO PLAYER VOLUME

The Video Player Volume output node allows controlling the Volume of the [Video Player](#)<sup>956</sup> integrated within Widget Designer.

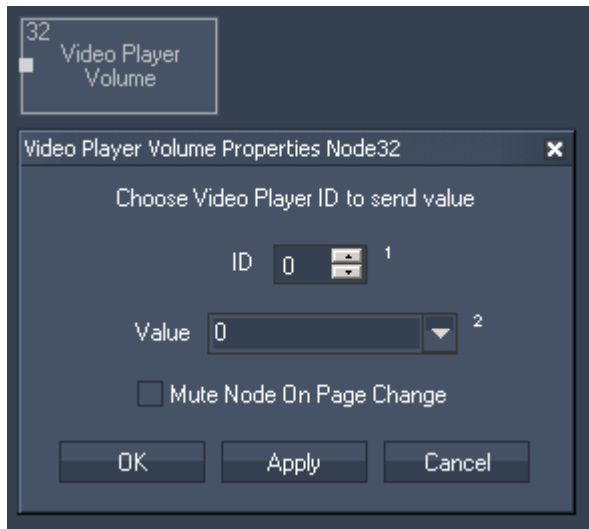

Node Properties:

Video Player ID:

Enter the Video Player ID.

Value:

Choose the input source that should remote control the Video Player Volume.

Tick the check box to Mute Node on Page Change.

### 17.4.8 SCRIPT NODES

Script nodes execute your customized script; they are triggered through a certain action. Please see the introductory chapter if you like to learn more about other node types or [how to create and work with nodes](#)<sup>964</sup> in general.

#### [COM SCRIPT](#)<sup>1141</sup>

The COM script node allows receiving either ASCII or Byte values over a local COM port connection. Any input data can be linked to directly execute dedicated commands.

#### [TCP SCRIPT](#)<sup>1142</sup>

The TCP script node allows receiving either ASCII or Byte values over a local TCP connection. Any input data can be linked to directly execute dedicated commands.

#### [UDP SCRIPT](#)<sup>1143</sup>

The UDP script node allows receiving either ASCII or Byte values over a local UDP connection. Any input data can be linked to directly execute dedicated commands.

#### [PHIDGET IR SCRIPT](#)<sup>1144</sup>

The Phidget IR script node allows linking commands to incoming IR Codes.

#### [PHIDGET RFID SCRIPT](#)<sup>1145</sup>

The Phidget RFID script node allows linking commands to incoming RFID Codes.

### 17.4.8.1 COM SCRIPTS

The COM script node allows receiving either ASCII, decimal or hexadecimal values over a local COM port connection. Any input data can be linked to directly execute a dedicated script within WD. The COM Port connection needs to be enabled in the [Connection Manager](#)<sup>1166</sup>.

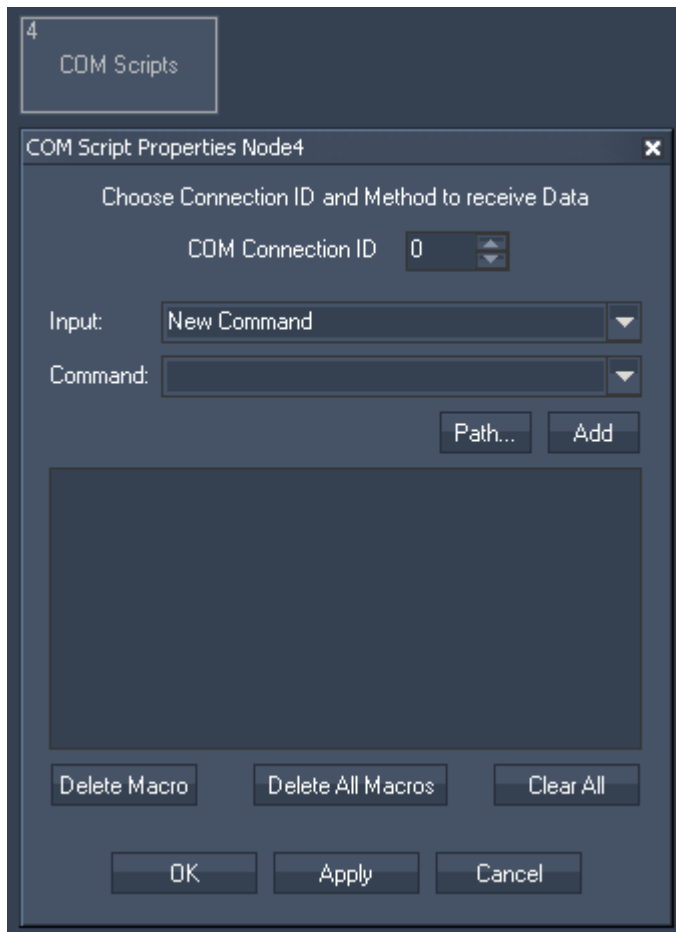

Node Properties:

COM Connection ID:

Enter the ID of the [COM Port Connection](#)<sup>1166</sup>.

Input:

Please enter the string of the incoming data for which you want a command to be executed. Please note that values can only be entered in ASCII, not hexadecimal, decimal or mixed. Special symbols are not supported. Please use the [COM Port Input node](#)<sup>994</sup> or [COM ASCII Stream Input node](#)<sup>995</sup> instead.

Command:

In the Script section you may enter commands to be executed when the according data is received. Each "Input" string may have a different script assigned.

To enter commands you may use the drop-down list and the "Add" button or type directly in the text field. The topic [Script Language](#)<sup>1254</sup> explains this in more detail.

Use [Delete Macro] to delete the selected script.

Use [Delete All Macros] to delete all scripts.

Use [Clear All] to clear the script text box of the selected script.

### 17.4.8.2 TCP SCRIPTS

The TCP script node allows receiving either ASCII, decimal or hexadecimal values over a local TCP connection. Any input data can be linked to directly execute a dedicated script within WD. The TCP connection needs to be enabled in the [Connection Manager](#)<sup>1166</sup>.

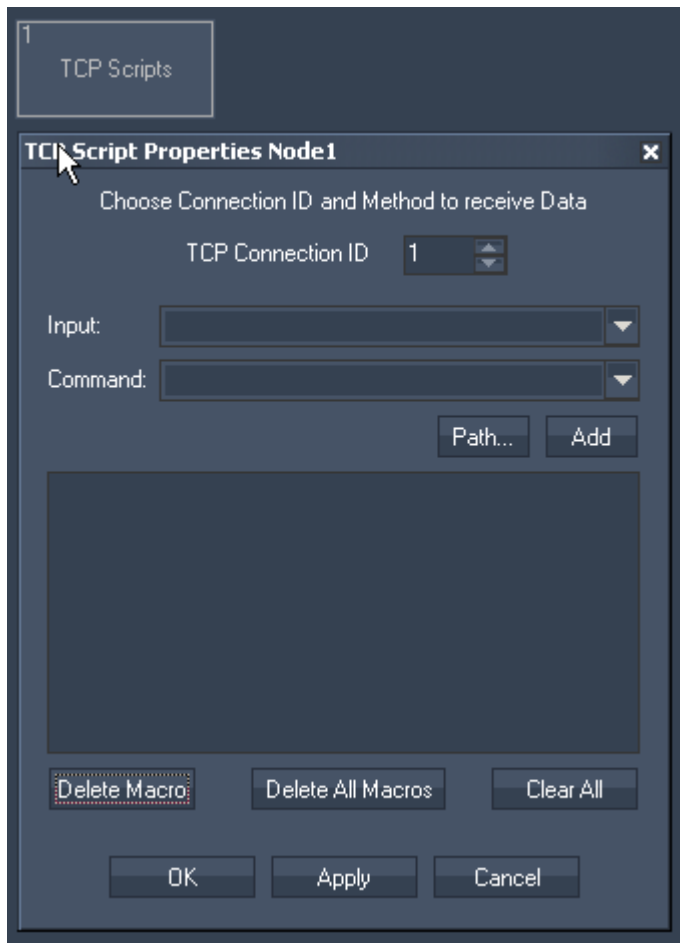

Node Properties:

TCP Connection ID:

Enter the ID of the [TCP Port connection](#)<sup>1166</sup>.

Input:

Please enter the string of the incoming data for which you want a command to be executed. Please note that values can only be entered in ASCII, not hexadecimal, decimal or mixed. Special symbols are not supported. Please use the [TCP Input node](#)<sup>1059</sup> or [TCP ASCII Stream Input node](#)<sup>1060</sup> instead.

Command:

In the Script section you may enter commands to be executed when the according data is received. Each "Input" string may have a different script assigned.

To enter commands you may use the drop-down list and the "Add" button or type directly in the text field. The topic [Script Language](#)<sup>1254</sup> explains this in more detail.

Use [Delete Macro] to delete the selected script.

Use [Delete All Macros] to delete all scripts.

Use [Clear All] to clear the script text box of the selected script.

### 17.4.8.3 UDP SCRIPTS

The UDP script node allows receiving either ASCII, decimal or hexadecimal values over a local UDP connection. Any input data can be linked to directly execute a dedicated script within WD. The UDP connection needs to be enabled in the [Connection Manager](#)<sup>1166</sup>.

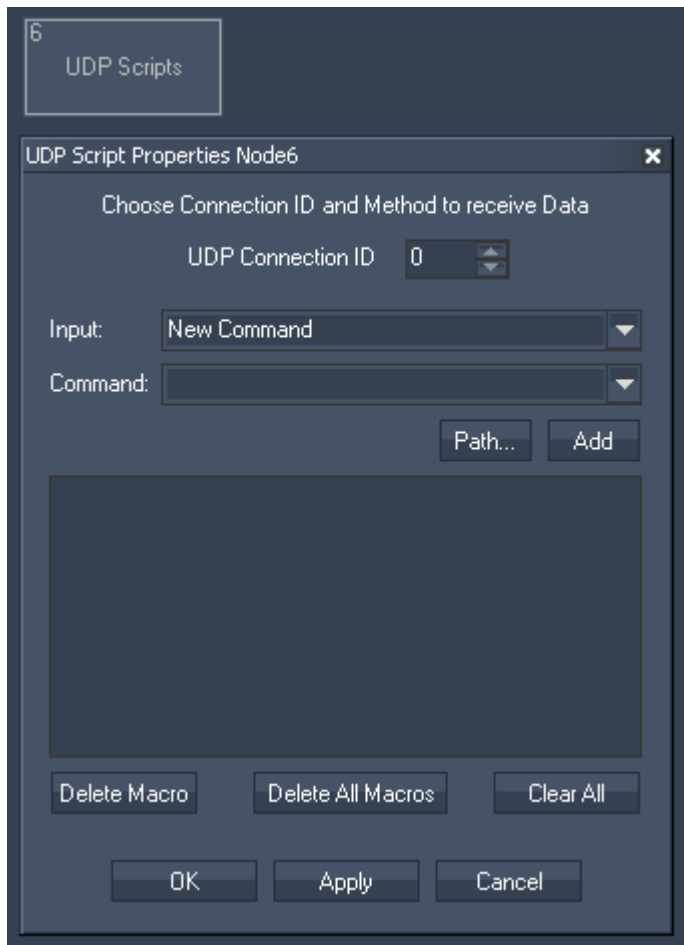

Node Properties:

UDP Connection ID:

Enter the ID of the [UDP Port connection](#)<sup>1166</sup>.

Input:

Please enter the string of the incoming data for which you want a command to be executed. Please note that values can only be entered in ASCII, not hexadecimal, decimal or mixed. Special symbols are not supported. Please use the [UDP Input node](#)<sup>1065</sup> or [UDP ASCII Stream Input node](#)<sup>1066</sup> instead.

Command:

In the Script section you may enter commands to be executed when the according data is received. Each "Input" string may have a different script assigned.

To enter commands you may use the drop-down list and the "Add" button or type directly in the text field. The topic [Script Language](#)<sup>1254</sup> explains this in more detail.

Use [Delete Macro] to delete the selected script.

Use [Delete All Macros] to delete all scripts.

Use [Clear All] to clear the script text box of the selected script.

### 17.4.8.4 PHIDGET IR SCRIPTS

The Phidget IR script node allows linking scripts to incoming IR Codes.  
 Please set up the [Phidget IR Receiver Transmitter Tool](#)<sup>1233</sup> first in order to enable the IR controller.

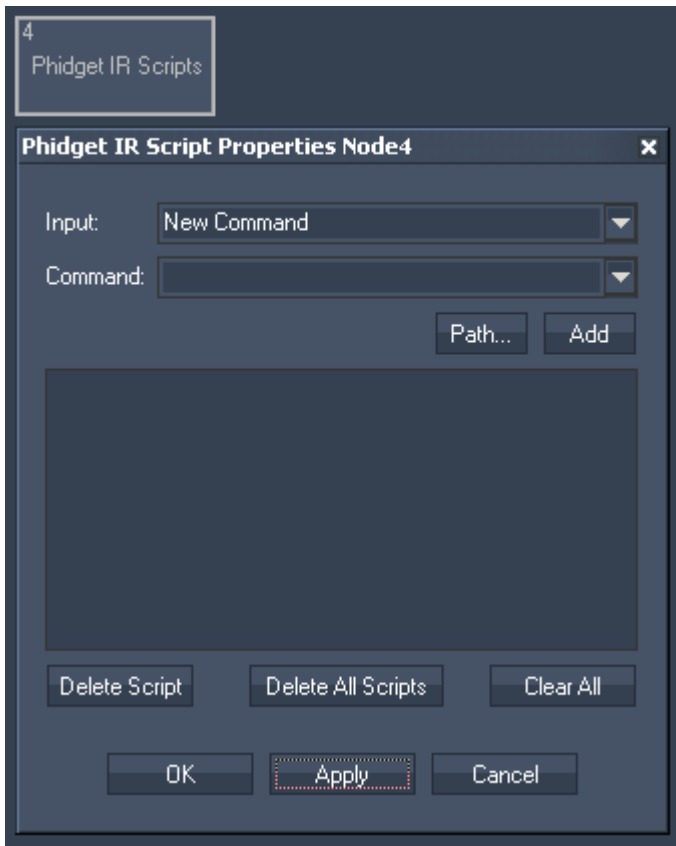

Node Properties:

**Input:**

Please enter the incoming data string you want a command to be executed.

**Command:**

In the Script section you may enter commands to be executed when the according data is received. Each "Input" string may have a different script assigned.

To enter commands you may use the drop-down list and the "Add" button or type directly in the text field. The topic [Script Language](#)<sup>1254</sup> explains this in more detail.

Use [Delete Script] to delete the selected script.

Use [Delete All Scripts] to delete all scripts.

Use [Clear All] to clear the script text box of the selected script.



### 17.4.8.5 PHIDGET RFID SCRIPTS

The Phidget RFID script node allows linking scripts to incoming RFID Codes. Please set up the [Phidget RFID Tool](#)<sup>1234</sup> first in order to enable the RFID controller.

Please note:

It is possible that the Phidgets RFID do work only under Win7.

App hang has occurred on XP when a RFID Tool and RFID Script Node Property Window is open at the same time

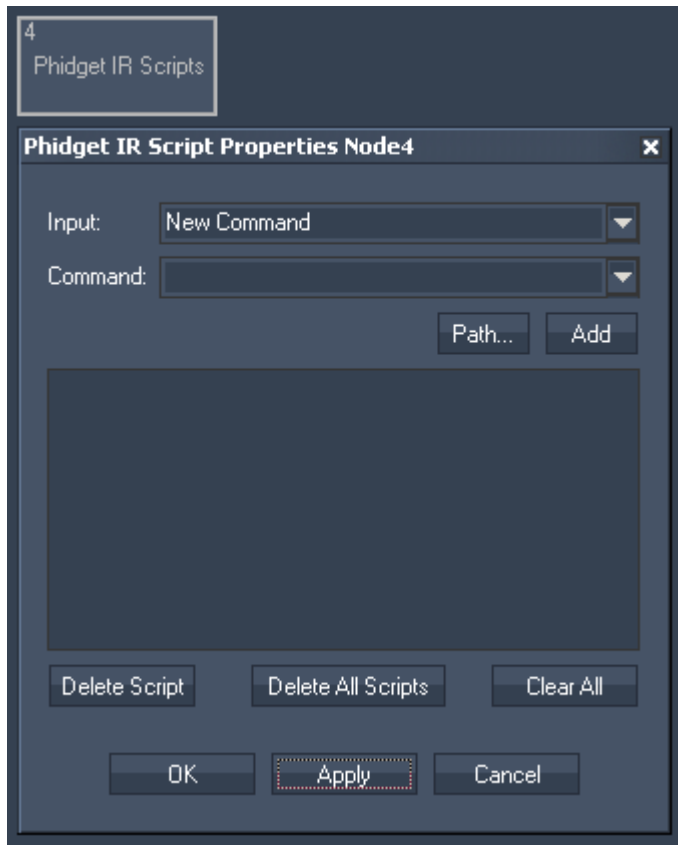

Node Properties:

Input:

Please enter the incoming data string you want a command to be executed.

Command:

In the Script section you may enter commands to be executed when the according data is received. Each "Input" string may have a different script assigned.

To enter commands you may use the drop-down list and the "Add" button or type directly in the text field. The topic [Script Language](#)<sup>1254</sup> explains this in more detail.

Use [Delete Script] to delete the selected script.

Use [Delete All Scripts] to delete all scripts.

Use [Clear All] to clear the script text box of the selected script.

## 17.4.9 INTERACTION NODES

Interaction nodes execute an underlying application that enables to interact with a remote system. Please see the introductory chapter if you like to learn more about other node types or [how to create and work with nodes](#)<sup>964</sup> in general.

### [Touch Injection](#)<sup>1147</sup>

With the Touch Injection Interaction node you may send touch data to a dedicated Output of a Pandoras Box Site. The touch data is injected there meaning that it is as if it was generated on the remote machine using a connected touch screen for instance.

### [Mouse Injection](#)<sup>1148</sup>

With the Mouse Injection Interaction node you may send mouse click and move data to a dedicated Output of a Pandoras Box Site. The mouse data is injected there meaning that it is as if it was generated on the remote machine using a connected mouse for instance.

### [Mouse Draw to Canvas](#)<sup>1148</sup>

With the Mouse Draw to Canvas Interaction node you may send mouse click and move data to a dedicated Canvas asset in Pandoras Box to draw on it. The mouse data (happening in Widget Designer) is injected into the Pandoras Box system meaning that it is as if it was generated on the remote machine using a connected mouse for instance.

### [Layer UV Draw to Canvas](#)<sup>1150</sup>

With the Layer UV Draw to Canvas Interaction node you may send mouse click and move data to a dedicated Canvas asset in Pandoras Box to draw on it. In difference to the previously described "Mouse Draw to Canvas" node, this node does not work with the mouse connected to the Widget Designer system but with a mouse / touch /... input connected to the PB Client or Master directly. This means that this node routes the remote input events to a Canvas.

Below the explanation of the node's parameters, you will find a step-by-step description of the settings from Widget Designer and Pandoras Box that are necessary when drawing on a Canvas, or receiving mouse or touch input events in general.

### 17.4.9.1 TOUCH INJECTION

With the Touch Injection Interaction node you may send touch data to a dedicated Output of a Site. The touch data is injected there meaning that it is as if it was generated on the remote machine using a connected touch screen for instance.

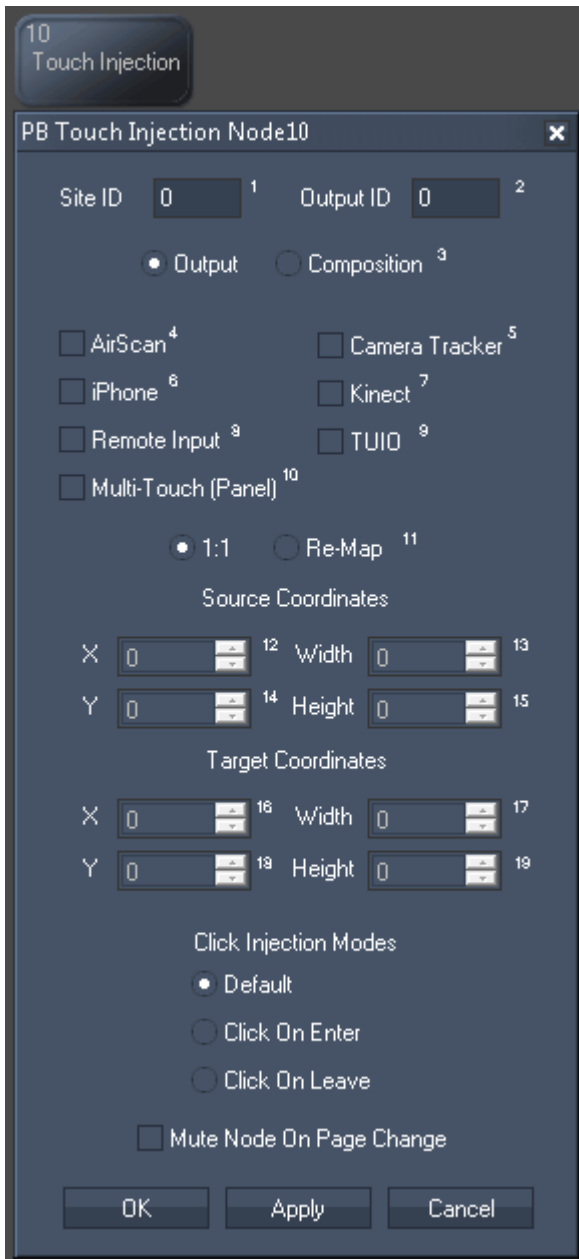

Set up the Site ID and Output ID from the Master or Client that you like to send the data to.

Decide whether the data should be injected to the Output or the Composition pass. [More information... 297](#)

Tick the according check-box for each tool that should generate touch data.

Choose between

- "1:1" to keep the resolution as on your local screen and

- "Re-Map" with more settings to send other coordinates to the remote computer. This is not only of interest when the screen resolution of the systems you inject input events in is different to the local resolution. But also when the resolution is much higher due to more outputs. In case the outputs are softedged you need to set up two Injection nodes with different source and target coordinates.

Lastly, you may set up what mode generates a click.

Tick the check box "Mute Node on Page Change" if the node should not process and output data when another page is active.

### 17.4.9.2 MOUSE INJECTION

With the Mouse Injection Interaction node you may send mouse click and move data to a dedicated Output of a Site. The mouse data is injected there meaning that it is as if it was generated on the remote machine using a connected mouse for instance.

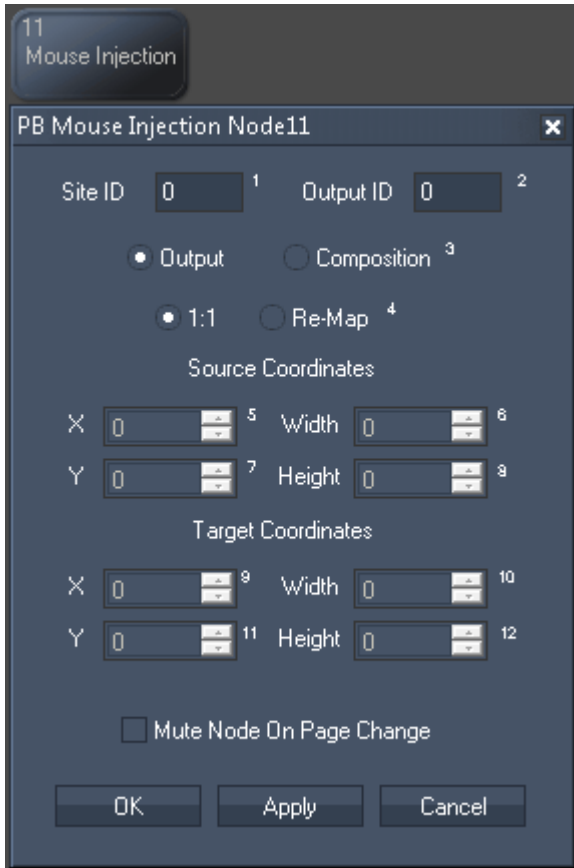

Set up the Site ID and Output ID from the Master or Client that you like to send the data to.

Decide whether the data should be injected to the Output or the Composition pass. [More information...](#)<sup>[297]</sup>

Choose between

- "1:1" to keep the resolution as on your local screen and
- "Re-Map" with more settings to send other coordinates to the remote computer. This is not only of interest when the screen resolution of the systems you inject input events in is different to the local resolution. But also when the resolution is much higher due to more outputs. In case the outputs are softedged you need to set up two Injection nodes with different source and target coordinates.

Tick the check box "Mute Node on Page Change" if the node should not process and output data when another page is active.

### 17.4.9.3 MOUSE DRAW TO CANVAS

With the Mouse Draw to Canvas Interaction node you may send mouse click and move data to a dedicated [Canvas asset](#)<sup>[250]</sup> in Pandoras Box to draw on it. The mouse data (happening in Widget Designer) is injected into the Pandoras Box system meaning that it is as if it was generated on the remote machine using a connected mouse for instance. Please see the next chapter about the node "[Layer UV Draw to Canvas](#)<sup>[1150]</sup>" if you like to draw on the Canvas with a mouse / touch /... input connected to the PB Client or Master directly.



Set up the Folder and File ID from the Canvas Asset

The Size parameter influences whether you draw a fine line or with a thicker brush.

With Red, Green, Blue and Alpha you set up the color of the brush. Note that small numbers next to parameter fields indicate that they can be changed with the command [NodeSetParam](#)<sup>1363</sup>.

Choose between

- "1:1" to keep the resolution as on your local screen and

- "Re-Map" with more settings to send other coordinates to the remote computer

In case you send. This is not only of interest when the screen resolution of the systems you inject input events in is different to the local resolution. But also when the resolution is much higher due to more outputs. In case the outputs are softedged you need to set up two Injection nodes with different source and target coordinates.

Tick the check box "Mute Node on Page Change" if the node should not process and output data when another page is active.

### 17.4.9.4 LAYER UV DRAW TO CANVAS

With the Layer UV Draw to Canvas Interaction node you may send mouse click and move data to a dedicated [Canvas asset](#)<sup>250</sup> in Pandoras Box to draw on it. In difference to the previously described "Mouse Draw to Canvas" node, this node does not work with the mouse connected to the Widget Designer system but with a mouse / touch /... input connected to the PB Client or Master directly. This means that this node routes the remote input events to a Canvas.

Below the explanation of the node's parameters, you will find a step-by-step description of the settings from Widget Designer and Pandoras Box that are necessary when drawing on a Canvas, or receiving mouse or touch input events in general.

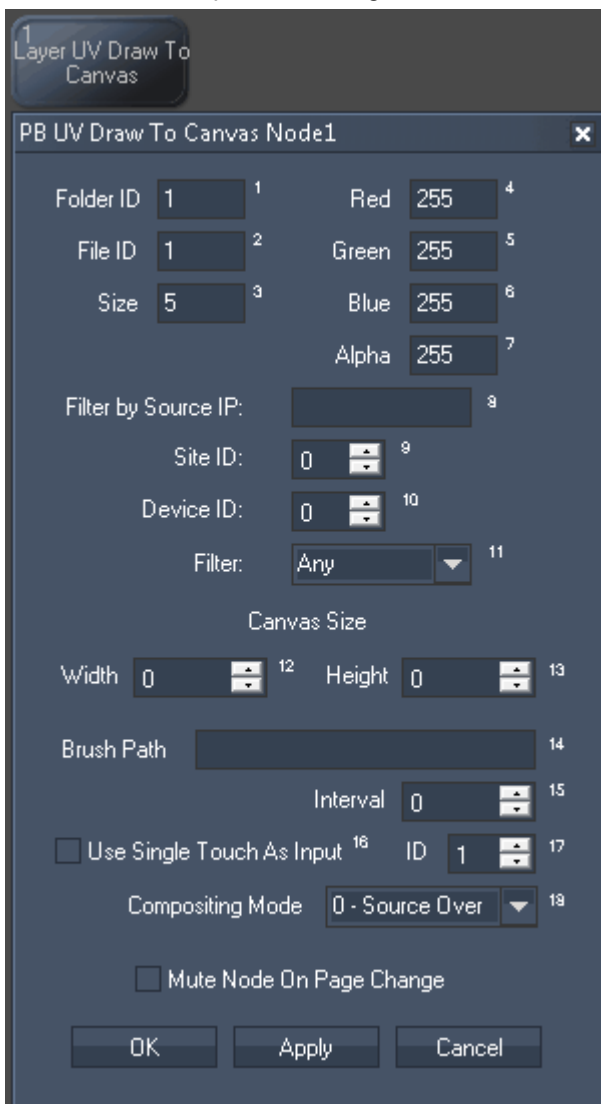

Set up the Folder and File ID from the Canvas Asset.

The Size parameter influences whether you draw a fine line or with a thicker brush.

With Red, Green, Blue and Alpha you set up the color of the brush. Note that small numbers next to parameter fields indicate that they can be changed with the command [NodeSetParam](#)<sup>1363</sup>.

If you like to filter input data from one Site or even only a Layer, enter the PB Masters IP address, the Site and Device ID and set the filter type.

Enter the same Canvas width and height as set up in the File Inspector in Pandoras Box.

Enter a Brush Path if you like to draw with a media e.g an image. The asset name is the one displayed in the PB master's Project tab (case-sensitive!), e.g. "Sub folder/Image.png".

The interval parameter influences how continuous or interrupted the drawn line looks like.

"Use Single Touch As Input" discards multiple input or touch data and takes only the input with the specific "ID".

The Compositing Mode influences the Overlay behavior of semi-transparent (Alpha < 255) lines drawn on the Canvas. "Source Over" covers any underlying layers, the Alpha level simply darkens the color. "Source Copy" does not cover existing layers fully but only according to the Alpha level, i.e. they shine through the Canvas Layer.

Tick the check box "Mute Node on Page Change" if the node should not process and output data when another page is active.

### **General connection settings in WD and PB required to communicate remote UV data**

The below screenshot depicts settings in Pandoras Box and Widget Designer for a test setup that shows how to draw on a Canvas, or receive mouse or touch input events in general:

- one Manager with WD on IP 192.168.2.120
- one Player Client (in fullscreen mode) on another PC with a mouse device attached

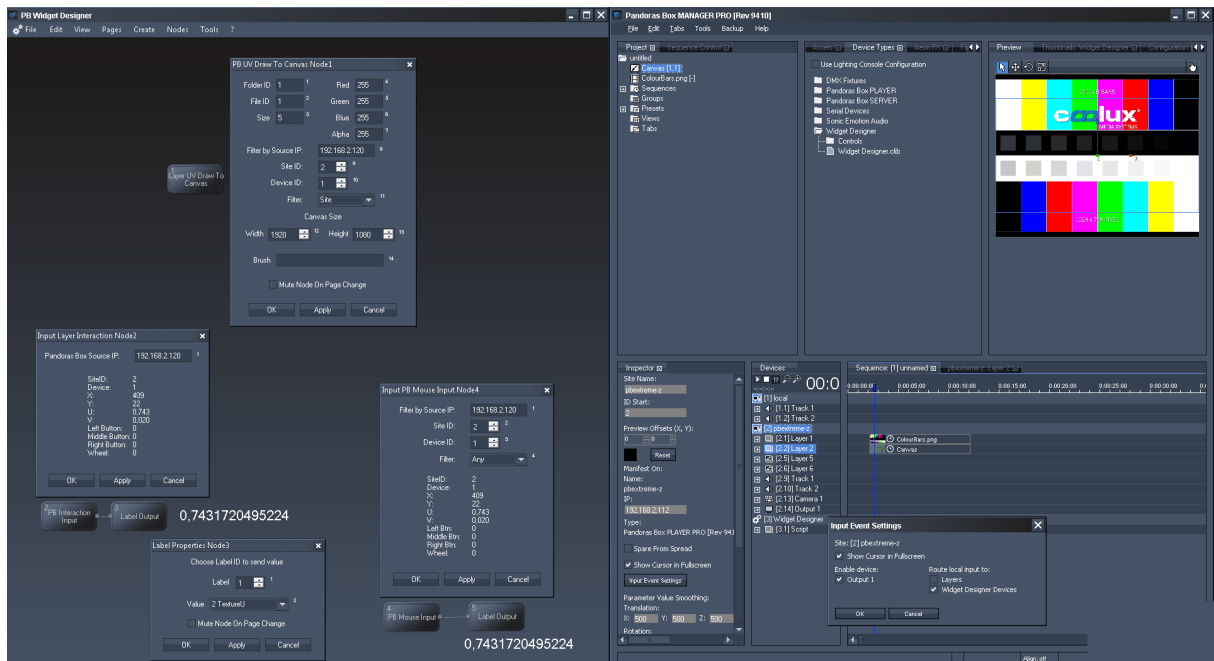

- in the PB Master, drag the Client into the Device tab and in addition a [Widget Designer device](#)<sup>609</sup> (from the Device Types tab > Widget Designer > Widget Designer.clib)
- select the WD Device and check the IP address in the [Inspector](#)<sup>188</sup> (in our case, as it runs on the same machine, it should be the local IP)
- in WD, go to Edit > [Pandoras Box IP Configuration](#)<sup>865</sup> and check the IP address from PB Master then scroll down to the "PB Widget Device Connection" section and tick the check box "Enable Connections"
- now, in the PB Master's Devices tab, the WD Device should not have a red exclamation mark anymore which means that it now is able to transmit (touch) data from the PB application to the WD application and its nodes)

## Receiving remote mouse / touch data from a PB Client or PB Master

Before drawing on a Canvas we will check that the UV touch data is send from the PB Client to the PB Master and from the PB Master to WD.

- first drag a testpattern into the PB project and display it on the first layer of the Client (Site/Device ID 2.1)
- in the PB Master's Devices tab, select the Client to display the settings in the [Inspector tab](#)<sup>206</sup> and click the button "[Input Event Settings](#)<sup>207</sup>". Tick the options for enabling the Output as well as for the Widget Designer Device. Optionally, tick the check box to render the mouse pointer in the fullscreen window
- in WD, go again to Edit > [Pandoras Box IP Configuration](#)<sup>865</sup> to the "PB Widget Device Connection" section and click the button "Input Tester" to open a dialog that should display incoming information when moving the input device in the PB Client
- alternatively, you can receive UV data from an input device connected to the PB Master: toggle the Client into the local PB Master's Preview and change to the Picking mode (by clicking the hand icon), [more information about the Picking Mode...](#)<sup>244</sup>

- if you like to view the incoming data outside this dialog, create a small node chain and a Label. 1) Nodes > Input > Pandoras Box > Layer Mouse Input and 2) Nodes > Output > Controls > Label
- in the PB Mouse Input node, enter the Master's (!!) IP address. If you like not to receive data from all sites and devices, enter the according Site ID and Device ID and set the filter drop-down menu to suit your needs. For our purpose, this is not needed, so the filter can say "Any"
- in WD, set the Label Output node to display the "Texture U" data in the according Label. If you now



---

move the Client's attached mouse from left to right in the fullscreen render window, the Label should display texture data from 0 - 1

If this is working, the data transmission works fine. Now we can set up to draw in the Clients screen.

### **Forwarding remote mouse / touch data to a Drawing Canvas**

- first in the PB Master's Project tab, create a [Drawing Canvas](#)<sup>[250]</sup> asset and assign Folder / File ID 1/1 using the Inspector. Set up the resolution you need and then assign it to the client's second layer (2.2)

- in WD, create the node Nodes > Interaction > Layer UV Draw to Canvas Pandoras Box. The obligatory settings are what Folder / File ID the Canvas asset has (in our case 1/1), what width / height it has and what the Source IP is ( the PB Master is in our case the local IP). Optionally you can set up a color and size for the "pen", this is described at the top of this chapter.

- as already mentioned above, you can as well draw on the Canvas with the mouse connected to the PB Master: toggle the Client into the local PB Master's Preview and change to the Picking mode (by clicking the hand icon), [more information about the Picking Mode...](#)<sup>[244]</sup>

## 17.5 TOOLS

The Tools menu provides many useful tools to set up and configure your project items as well as various input and output protocol settings.

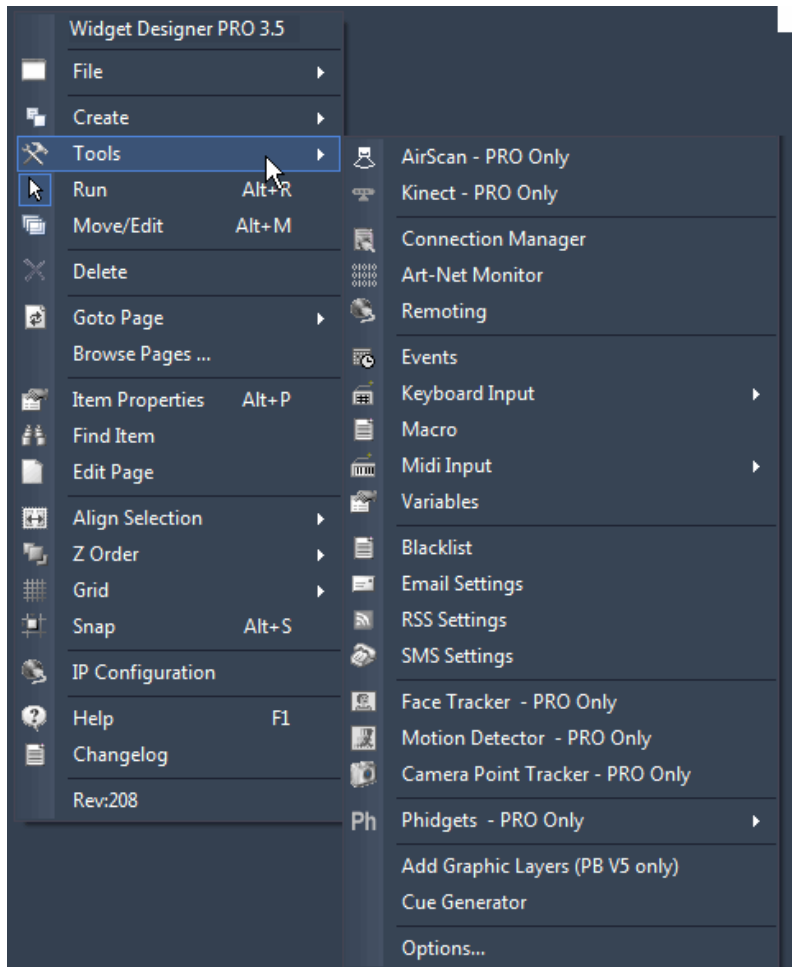

For detailed description please see the following pages:

[AirScan](#)<sup>1155</sup> (WD PRO only)

[Kinect](#)<sup>1162</sup> (WD PRO only, Win7 only)

[Connection Manager](#)<sup>1166</sup>

[Art-Net Monitor](#)<sup>1177</sup>

[Remoting](#)<sup>1182</sup>

[Events](#)<sup>1188</sup>

[Keyboard Input](#)<sup>1203</sup>

[Macro](#)<sup>1191</sup> (WD PRO only)

[Midi Input](#)<sup>1208</sup>

[Variables](#)<sup>1193</sup>

[Blacklist](#)<sup>1214</sup> (WD PRO only)

[Email Settings](#)<sup>1214</sup> (WD PRO only)

[RSS Settings](#)<sup>1217</sup> (WD PRO only)

[SMS Settings](#)<sup>1219</sup> (WD PRO only)

[Face Tracker](#)<sup>1222</sup> (WD PRO only)

[Motion Detector](#)<sup>1223</sup> (WD PRO only)

---

[Camera Point Tracker](#)<sup>1224</sup> (WD PRO only)

[Phidgets](#)<sup>1231</sup> (WD PRO only)

[Add Graphic Layers \(PB V5 only\)](#)<sup>1242</sup>

[Cue Generator](#)<sup>1245</sup>

[Options...](#)<sup>1252</sup>

## 17.5.1 AIRSCAN

The AirScan touch-less hardware interface is available as optional input device for Widget Designer.

The AirScan is based on a rotation IR Laser field that allows to read two point multi-touch input gestures and use them for various applications within Widget Designer.

The AirScan Device itself due to its IR laser Technology should not be exposed to direct sunlight or direct tungsten lighting as this would distort the correct readout of the sensed data.

See here the related topics:

[How to use the AirScan](#)<sup>1155</sup>

[AirScan Tool Setup](#)<sup>1156</sup>

### 17.5.1.1 HOW TO USE THE AIRSCAN?

The AirScan can be used for any touch-less screen interaction or RP projection touch surface.

The unit can be mounted above or below the screen and its recommended distance to the input screen area should be not further away then 10m or 30ft. Longer distances can be set up, but will lead to a less accurate readout.

The AirScan measures every 0.36 degrees if anything has crossed the screen area.

The AirScan then transmits its data via TCP over network to Widget Designer for further data processing.

### 17.5.1.2 AIRSCAN TOOL SETUP

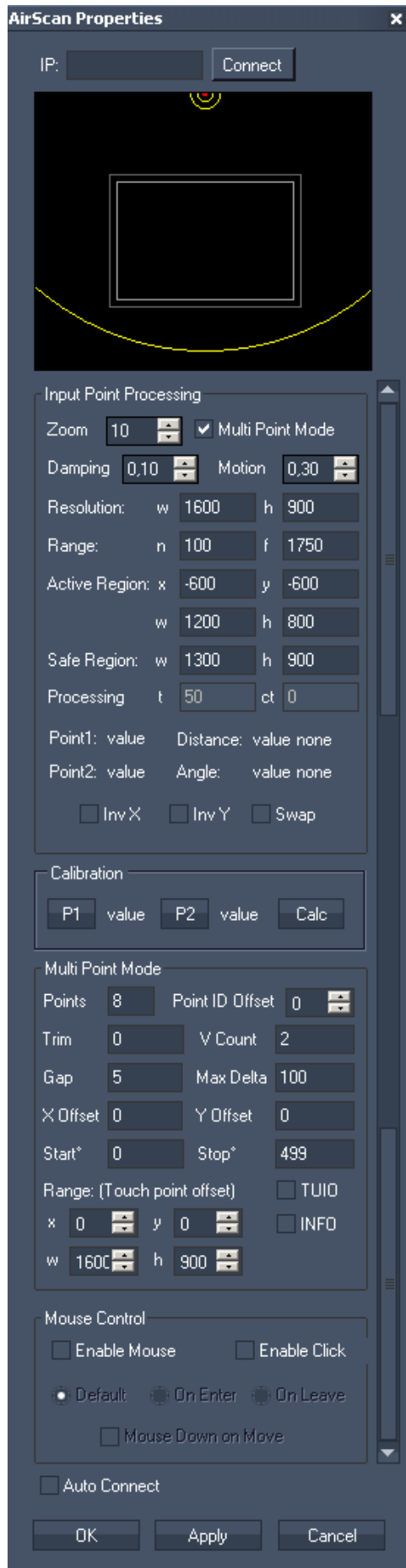

In the AirScan setup tool you set up and connect to the IP address of the unit.

Once connected you will see a yellow outline of the laser field. The input screen rectangle needs to be placed between a minimum and maximum range. All setup parameter related to the AirScan values are set in millimeters.

Once you got your touch data into the system you can map the first point to the local mouse and use one or more additional multi-touch points with a Multitouch Panel or an XY Panel.

The AirScan Tool is divided into several sections:

[General Settings.](#) <sup>1157</sup>

[Input Point Processing.](#) <sup>1157</sup>

[Calibration.](#) <sup>1158</sup>

[Multipoint Mode](#) <sup>1159</sup>

[Mouse Control](#) <sup>1160</sup> and the

[Point Read-out.](#) <sup>1161</sup>

### 17.5.1.2.1 GENERAL SETTINGS

IP:

Enter the AirScan's IP address and click [Connect] to the AirScan.

Now you should see a yellow outline of the laser field.

Auto Connect (at the bottom of the AirScan Tool):

Check this option to automatically connect to the AirScan (once the connection to the AirScan is established) after a disconnect or restart of the Widget Designer.

### 17.5.1.2.2 INPUT POINT PROCESSING

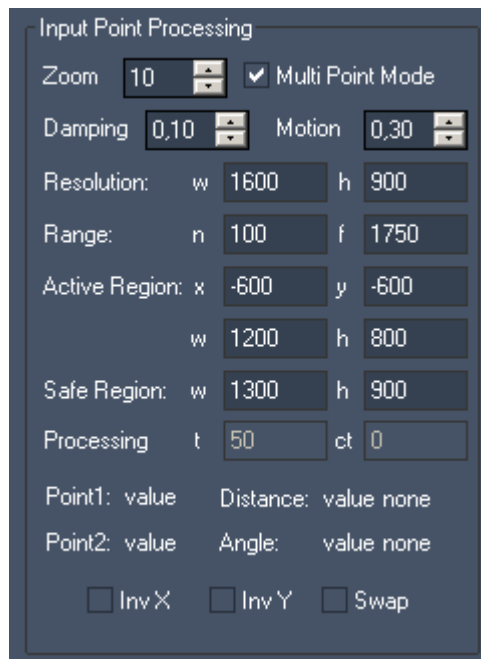

Zoom:

Use the zoom factor to zoom in / out the AirScan field.

Multi Point Mode:

The Multi Point Mode is checked by default, it allows to detect up to 24 points. With this mode the performance and precision of point detection is enhanced compared to the previous detection mode (that only allowed to detect two points).

To use the multi-point read-out for further processing, please use the [AirScan Multi-Point Input Node](#)<sup>986</sup>.

When not using the Multi Point Mode, please use the [AirScan Input Node](#)<sup>985</sup> for further processing.

Damping:

As you can see in the AirScan setup tool there is also a damping filter value. This value is important as the IR readout of the AirScan can have noticeable noise that is filtered out with this prediction based damping.

The damping factor is set by default to 0,10. You can change this setting from 0,1 = maximum damping up to 1 = no damping.

Motion:

The Dynamic Motion Damping improves the stability of the touch point in motion and stabilizes the

points when they are not moving. It is set by default to 0,3. Its value ranges from 0 (max. smoothness) to 1 (no motion filtering).

**Resolution:**

Enter here the resolution of your Widget Designer GUI (width and height).

**Range:**

The Range is defined through n (near field) and f (far field) in mm.

Beyond this range no AirScan position data will be transferred to the Widget Designer. Please be sure that the Active Field (the white rectangle) is positioned within the near and far field.

**Active Region:**

X&Y - The coordinates x and y define the position of the Active Region in relation to the AirScan's position in mm. Please enter the size of the region for W (Width) and H (Height) in mm.

W&H - Enter here the size of the Active Region (width and height) in mm.

**Safe Region:**

The Safe Region makes the detection of points on the border of the active region more robust. Enter values in mm for X&Y, ideally the Safe Region is a bit bigger than the Active Region.

Processing (only used when the older mode for only 2 point detection is chosen):

t (Threshold) is equivalent to the angle-ray-count to the distance between point 1 and 2.

ct (count) is the maximum ray count per point.

**Inv X / Inv Y / Swap**

Use these options if the AirScan is not located above the active field.

If the AirScan position is e.g. below the active field, check Inv Y to receive correct Y Position data.

**17.5.1.2.3 CALIBRATION**

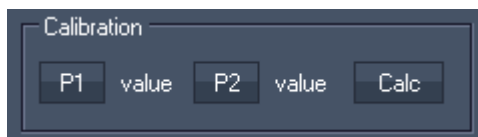

The calibration buttons enable an intuitive calibration of the Active Region.

**[P1], [P2]:**

[P1] captures the coordinates of the upper left corner (as seen in the AirScan tool).

[P2] captures the coordinates of the lower right corner (as seen in the AirScan tool).

Both corner orientations refer to the view in the AirScan Tool.

**How to do the Auto-Calibration?**

Interrupt the AirScan field at the position of the first corner, press [P1]. You will see the corner's position (x/y in px) next to the button. Now interrupt the AirScan field at the position of the second corner, press [P2]. When this is done, press [Calc] and the position values will be transferred into the Active Region Settings. Please note: the Safe Region has to be adjusted manually!

### 17.5.1.2.4 MULTI POINT MODE

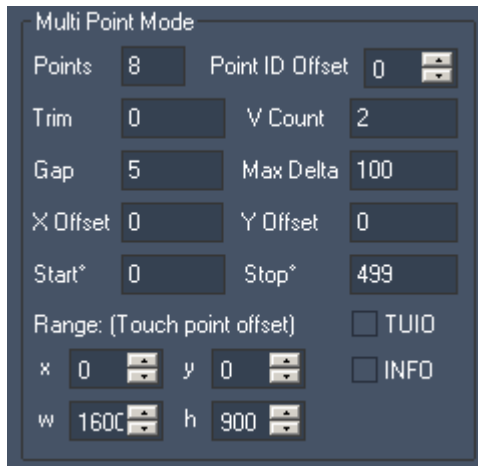

The Multi Point Mode is used by default unless you disable this function in the Input Point Processing.

Points:

Enter here the amount of points that should be detected and provided for further processing.

Point ID Offset:

The Point ID Offset should be used when you are sending the Multitouch data from this AirScan via the [Remote Input](#)<sup>1169</sup> to another Widget Designer. It avoids that the Multitouch points from several data inputs get the same IDs and that there are any ID conflicts.

Trim:

Trim allows to minimize errors on Point enter, with this value a number of scans will be ignored until the point motion processing is activated. The default value for Trim is 0.

VCount (Validation Count)

The Validation Count defines the amount of rays that have to be interrupted in order to validate a touch point. The default value is 2.

Gap:

The default value for the Gap is 5. This means that within 5 rays distance of a detected point all other interrupts will be discarded.

Max Delta:

The default value for Max Delta is 100. The Max Delta function determines the maximum speed for Multi touch Point Tracking.

X&Y Offset:

These offsets allow to run the Widget Designer on a secondary screen. If you're doing so please enter here the pixel offset for x and y.

Example: resolution of primary and secondary screen is 1024x768, WD runs on the secondary screen, enter x=1025 and y=0.

Start Ray:

The AirScan sends out 500 Rays over 180° clockwise. If you want to discard rays up from the start, enter the new value here (0-499).

Stop Ray:

The AirScan sends out 500 Rays over 180° clockwise. If you want to discard more or less rays, enter the new value here (0-499).

**Range: (Touch point offset):**

The Point offset for the Multi-Point mode allows running the WD on a secondary screen.

**TUIO:**

In order to output multi touch data to other applications this option allows to send the AirScan's multi touch data via the open source protocol TUIO.

This protocol is widely used around the world by many application developers and is a commonly known way to transmit the individual touches.

To use AirScan with TUIO, set up the TUIO host IP and Port in the [Connection Manager](#)<sup>1166</sup>.

**INFO:**

Enable this check box to show the [Point Read-Out Dialog](#)<sup>1161</sup> with the data of all multi touch points.

<b>P1</b> Point Active value Point Enter value Point Move value Point Leave value	<b>P2</b> Point Active value Point Enter value Point Move value Point Leave value	<b>P3</b> Point Active value Point Enter value Point Move value Point Leave value	<b>P4</b> Point Active value Point Enter value Point Move value Point Leave value
<b>P5</b> Point Active value Point Enter value Point Move value Point Leave value	<b>P6</b> Point Active value Point Enter value Point Move value Point Leave value	<b>P7</b> Point Active value Point Enter value Point Move value Point Leave value	<b>P8</b> Point Active value Point Enter value Point Move value Point Leave value
<b>P9</b> Point Active value Point Enter value Point Move value Point Leave value	<b>P10</b> Point Active value Point Enter value Point Move value Point Leave value	<b>P11</b> Point Active value Point Enter value Point Move value Point Leave value	<b>P12</b> Point Active value Point Enter value Point Move value Point Leave value
<b>P13</b> Point Active value Point Enter value Point Move value Point Leave value	<b>P14</b> Point Active value Point Enter value Point Move value Point Leave value	<b>P15</b> Point Active value Point Enter value Point Move value Point Leave value	<b>P16</b> Point Active value Point Enter value Point Move value Point Leave value
<b>P17</b> Point Active value Point Enter value Point Move value Point Leave value	<b>P18</b> Point Active value Point Enter value Point Move value Point Leave value	<b>P19</b> Point Active value Point Enter value Point Move value Point Leave value	<b>P20</b> Point Active value Point Enter value Point Move value Point Leave value
<b>P21</b> Point Active value Point Enter value Point Move value Point Leave value	<b>P22</b> Point Active value Point Enter value Point Move value Point Leave value	<b>P23</b> Point Active value Point Enter value Point Move value Point Leave value	<b>P24</b> Point Active value Point Enter value Point Move value Point Leave value

### 17.5.1.2.5 MOUSE CONTROL

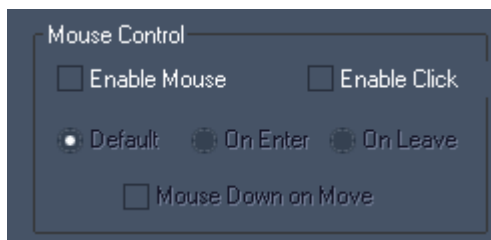

**Enable Mouse**

Check this option if the Point1 input data should control the mouse of your WD computer.

**Enable Click**

If this option is checked the mouse cursor generates clicks. Use the tick boxes to define when the click should be executed.

Default generates mouse down on enter and mouse up on leave.

On Enter: the click is generated on enter.

On Leave: the click is generated on leave.



Another option to generate a click on a [Custom Script Button](#)<sup>884</sup> is not to use "Enable Click" but to use the buttons timeout settings. When positioning the mouse cursor over a button for e.g. 500 ms a mouse click is executed automatically.

**Mouse Down on Move**

If this option is checked, left mouse down on move is always active.

**17.5.1.2.6 POINT READ-OUT**

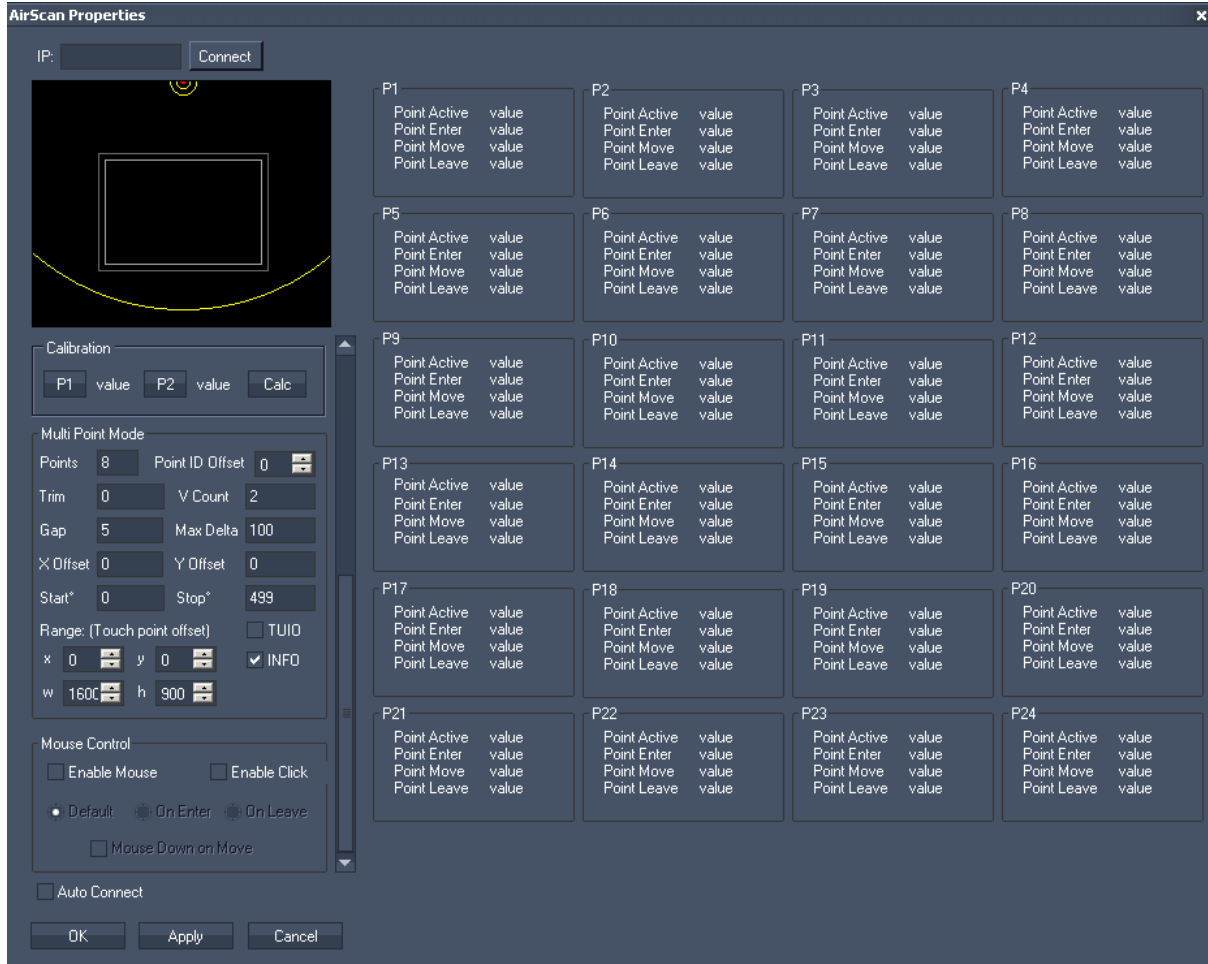

This section shows the status for up to 24 points.

Generally the first ray interrupt will be displayed as P1, second one as P2 and so on.

Each point will be tracked until it is removed out of the AirScan Field. So if there are P1 and P2 detected and P1 is removed, P2 stays P2 and does not changes its ID to be P1.

**Point Active (true or false)**

A point turns active as soon as there is a ray interrupt started inside the Active Region of the AirScan.

As long as the interrupt stays within the Safe Region, the point stays active.

If the interrupt started out of the Active Region or if there is no interrupt, the Point's status turns to False.

**Point Enter**

If there is an interrupt detected inside the Safe Region (whether it is active or not), the value for the X & Y position of a Point where it entered the AirScan field will be displayed here.

**Point Move**

As long as the value for Point Enter is true (1), the X and Y position of this Point will be displayed here.

Point Leave:

The last valid X & Y position of a Point while leaving the AirScan field will be displayed here.

To use this point read-out for further processing, please use the [AirScan Multi-Point Input Node](#)<sup>986</sup>.

To control the AirScan via commands, please use [these ones](#)<sup>1312</sup>:

## 17.5.2 KINECT

The Kinect hardware interface is available as optional input device for Widget Designer. It can be used for capturing up to 8 filtered and tracked points/regions of interest.

Use the Kinect Tool to control PB via the [Multitouch Panel](#)<sup>936</sup>, to control the mouse of your WD computer in order to e.g. proceed button click or process the data you get out of the [Kinect Input Node](#)<sup>1032</sup>.

Originally designed for Xbox the Kinect Sensor features a Colour Camera and a so called Depth Camera. The Depth Sensor (640x480@30fps) delivers a distance value per pixel (0-2047 units). It has an angular field of view of 57° horizontally and of 43° vertically.

The Depth Camera is used to determine motion at specific distances; it can read distance data between 1.2 - 3.5m distance quite well.

A motorized pivot is capable of tilting the sensor as much as 27° either up or down.

### Important Notice Regarding Kinect Device usage:

Kinect driver from codelaboratories is still an early version and seems to run stable on WIN7 only. When the Kinect Device is connected to a Win7 system there might be a driver conflict when using Logitech USB cameras at the same time.

Please install the Platform driver first in order to use Kinect within Widget.

The Kinect must be plugged in for the Driver to work other wise it will terminate the WD application when no device is attached.

Current Kinect Driver for Win 7 64bit Systems:

<http://codelaboratories.com/downloads/>

This driver MUST be used in order to work with the Kinect device.

Please note:

Do not use the Kinect Dialog in Show mode (the rendering of the Depth Camera requires too much system performance).

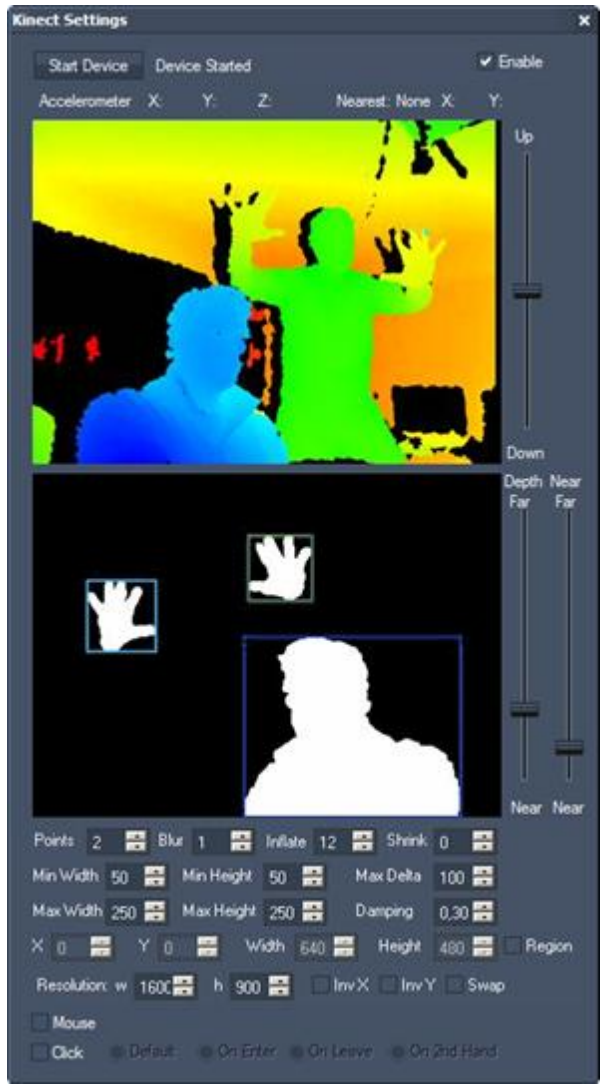

**Starting and adjusting the device**

To start the Kinect device, tick the [enable]-check box and press the button [Start Device]. Now you should see the colored camera image in the upper image field.

**Depth camera image:**

The different colors symbolize different distances from the sensor (e.g. blue=very near, orange=far).

**Motorized Pivot:**

Use the fader next to the upper camera image to bring the Kinect’s sensor in the right position by tilting it up and down.

**Binary camera image:**

In this image every item that is detected by the camera in between a certain distance range will be shown as white parts on a black background. To define which distance range should be taken, use the faders “Depth” and “Near” next to the binary camera image.

**Depth and Near Faders:**

With these faders please define the distance range from which the points should be detected.

Move the Depth-Fader up or down to define the farthest point of the distance range.  
 Move the Near-Fader up or down to define the nearest point of the distance range.  
 The Near-Fader always has to be lower than the Depth-Fader.

**Points:**

By default two points will be detected. Change this value to decrease it down to one point or increase it to get up to eight points.

If you choose Points=0, a Fullscreen Mask in Kinect Dialog is shown - currently built-in for evaluation purposes.

**Image processing settings****Blur:**

Use this option to smooth the detected areas, so that rough pixels become smooth spots (0 = minimum blur, 15 = maximum blur).

Please be aware that this takes more performance!

**Inflate:**

This option inflates the detected areas (0 = minimum inflation, 15 = maximum inflation).

**Shrink:**

The result of the (eventually blurred and inflated) areas will be shrunk when using this option (0 = minimum shrinking, 15 = maximum shrinking).

**Please note:**

There are no recommendations which values would be best to enter for Blur, Inflate and Shrink. It depends on your setup and especially the lighting conditions.

**Points Detection****Min Width / Max Width:**

Define which minimum and maximum width (in pixels) a spot should have to be detected as point. The pixel sizes are related to the Kinect's camera resolution of 640x480 px.

**Min Height / Max Height:**

Define which minimum and maximum height (in pixels) a spot should have to be detected as point. The pixel sizes are related to the Kinect's camera resolution of 640x480 px.

**Max Delta:**

The Max Delta value defines how far a point is allowed to move (in px, related to the Kinect's resolution of 640x480 px) between two frames in order to still be detected as point.

**Damping:**

The damping allows to reduce noisy input values. The damping factor is set by default to 0,3. This setting can be changed from 0,1 = maximum damping up to 1 = no damping.

**Region:**

If it is necessary for a good point detection to use only a certain region of the Kinect's point of view, please check the option "Region". Every movement outside this region will not be executed.

**Width / Height:**

Choose the region's size by entering the values (px) for Width and Height. Please note that due to the Kinect's Camera resolution the maximum region size is 640x480 px.

**X/Y:**

The region's top left pixel is located in 0/0 (X/Y) by default. To move the region to a different position please enter the according X/Y position here.

**Resolution:**

Please enter here the resolution of your monitor. This is needed to adopt the positions of the detected points to fit to your screen.

**Inv X:**

Check "Inv X" if you need to invert the X axis.

**Inv Y:**

Check "Inv Y" if you need to invert the Y axis.

**Swap:**

Check "Swap" if you need to swap the X and Y axis, e.g. when the Kinect is turned about 90°.

**Mouse Control****Mouse:**

Enable the mouse if Point1 input data should control the mouse of your WD computer.

**Click:**

If this option is checked the mouse cursor generates clicks. Use the tick boxes to define when the click should be executed.

- Default generates mouse down on enter and mouse up on leave.
- On Enter: the click is generated on enter.
- On Leave: the click is generated on leave.
- On 2nd Hand: the click is generated as soon as a 2nd point (through the 2nd hand) is detected.

Another option to generate a click on a [Custom Script Button](#)<sup>884</sup> is not to use "Enable Click" but to use the buttons timeout settings. When positioning the mouse cursor over a button for e.g. 500 ms a mouse click is executed automatically.

To change the Kinect settings from e.g. a Custom Script Button, [these commands](#)<sup>1407</sup> are available.

## 17.5.3 CONNECTION MANAGER

The Connection Manager is the [tool](#)<sup>1154</sup> to setup all main input and output communication protocols. All connections and protocols set up here are accessible to any command and user control as well as Nodes for in and output communication.

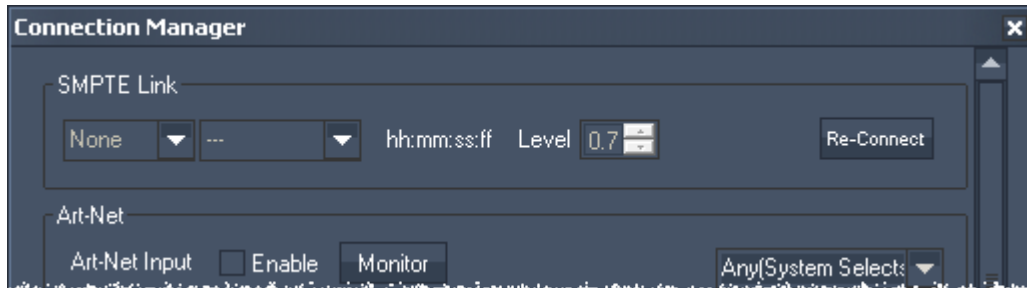

For further information please see

- [SMPTE Link](#)<sup>1166</sup>
- [Art-Net](#)<sup>1167</sup>
- [DMX Link](#)<sup>1168</sup>
- [Midi](#)<sup>1168</sup>
- [WD Remote Touch Input/Output](#)<sup>1169</sup>
- [TUIO Transmitter](#)<sup>1169</sup>
- TUIO Receiver
- ID Tag Tracking Server
- PSN MA Tracking Server
- OptiTrack Camera Connection Manager
- ID Tag
- IP Info & Setup
- [TCP Connections](#)<sup>1170</sup>
- [UDP Connections](#)<sup>1172</sup>
- [Serial COM Connections](#)<sup>1174</sup>

### Working with multiple network adapters

Where applicable, a protocol can be assigned to a dedicated network adapter using the Widget Designer ULT edition. This is of interest when working with multiple protocols that you would like to separate from each other or when dedicated IP addresses / ranges should be supported.

Per default, the Widget Designer PRO and STD use the same network adapter for each protocol. They cannot access the drop-down list to choose another adapter. If you open a new project in the PRO or STD, the drop-down list will always say "Any (System Selects)". That means that the operating system Windows decides what adapter is chosen. In general that would be the one that you have set up as the primary adapter in the (advanced) network settings.

However, if you have set up dedicated adapters using the ULT edition, and open this project in a PRO or STD, the settings still apply and are not discarded. If the operating system finds the named adapter it will use it for the desired protocol. Only if the system does not offer a network adapter with the exact name, the choice drops back to "Any...".

#### 17.5.3.1 SMPTE LINK

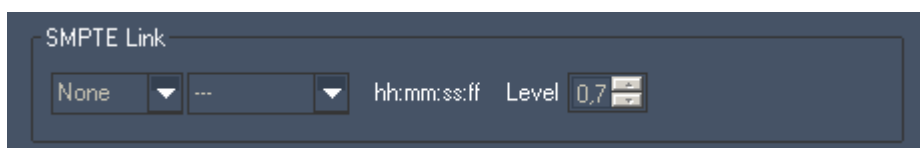

When a SMPTE Link device is connected to the WD computer, choose if you want to send or receive SMPTE timecode.

Choose the framerate from the second drop-down list if you are sending timecode.

In the text field next to the framerate you will see the current timecode. When you are in send mode, it allows you to enter the timecode start time manually.

Use the "[Timecode](#)<sup>955</sup>" control to display the current timecode on the WD userinterface. The SMPTE Link device can be controlled via [commands](#)<sup>1254</sup>.

You may also route the sent / received SMPTE Timecode via the [SMPTE Link Input Node](#)<sup>1055</sup> within the WD Node System.

### 17.5.3.2 ART-NET

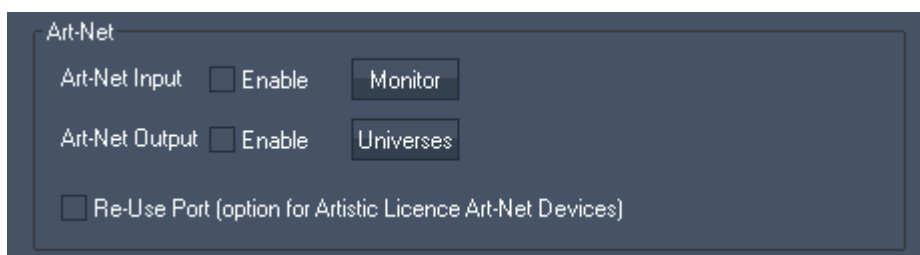

Art-Net can be used both as input and output. Art-Net can technically transmit up to 256 DMX Universes but you should be cautious about the amount of Universes to be sent and managed from one Widget Designer System. The processor and network card limit the amount of possible Art-Net universes.

By default if you enable Art-Net output, there are no values being sent until you use either an Art-Net Output Node or [Art-Net output commands](#)<sup>1398</sup>. Once, a particular DMX channel is sent on a given Art-Net Subnet and Universe, Widget Designer will store that universe as an output universe and constantly update this Universe. As defined in the Art-Net specifications, as soon as one channel is transmitted with a certain value, all other channels are included in the packet, if not specified, with a value of "0". In other words, a single channel data can not be send, it is send with the entire universe.

To display the Art-Net data received by Widget Designer, click on [[Art-Net Monitor](#)<sup>1177</sup>]. In the dialog you may select a subnet and universe. Then all channels are displayed with the according incoming Art-Net value. If you use WD to send Art-Net and you do so by broadcasting the values, you will be able to see these values in the Art-Net Monitor too. If you are unicasting the values, please switch to another Art-Net Monitor, e.g. the one in the [PB Menu](#)<sup>754</sup>. [More information](#)<sup>762</sup> about broadcast and unicast...

If you wish to stop sending specific Universes to the network you can open the Art-Net Universe List from the connection Manager and remove a Universe from the output list by right-clicking on the desired Subnet and Universe to delete the entry.



You may also use [commands](#)<sup>1399</sup> to deactivate a certain Subnet and Universe from being updated constantly anywhere where scripts are applicable in the user interface.

**Reuse Port:**

When reuse Port is checked Artistic License devices that require a reuse UDP port option are supported.

**17.5.3.3 DMX-LINK**

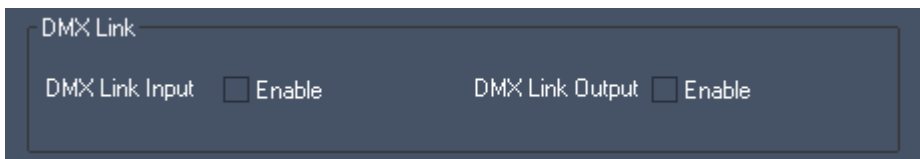

WD supports DMX Input data via the coolux DMXLink 1 Port IN device. To use this function, activate the check box "Enable".

You may receive and process the incoming DMX data via the DMX Link Input node.

DMX Output is supported via the coolux DMXLink 1 Port OUT device. To use this function, activate the check box "Enable".

**17.5.3.4 MIDI IN- & OUTPUT**

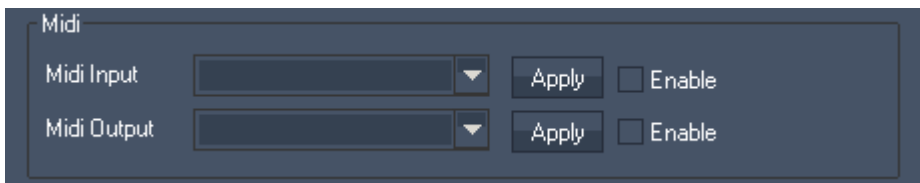

For Midi input and output connect and install a windows compatible midi device with the Widget Designers computer first in order to access and choose the device in the Connection Manager.



### 17.5.3.5 WD REMOTE TOUCH IN- & OUTPUT

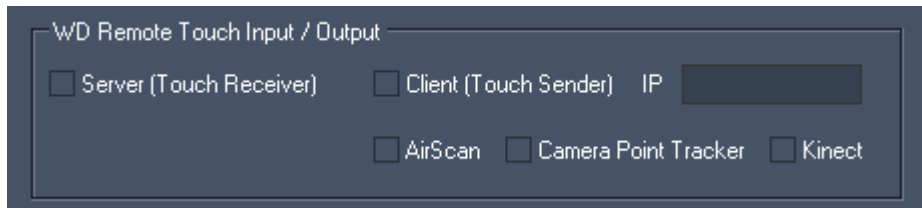

The WD Remote Touch Input/Output allows to share touch data within several Widget Designer instances (one WD Master receives the data, several WD Clients may send it). This enables you to work with multiple cameras, AirScans or Kinect devices. The touch data handling can be split to several processes or computers.

Server (Touch Receiver):

Enable the server if you want to receive touch data from other WD instances.

Client (Touch Sender):

In order to send the touch data of this WD instance to another WD (set up as Remote Touch Input Server), enter the IP address of the WD Server and tick the check box [Client (Touch Sender)]. The receiving WD may run on the same computer or on a different one.

Enable the devices that should send its touch data to the WD Server:

[AirScan](#)<sup>1155</sup>, [Camera Point Tracker](#)<sup>1224</sup> and/or [Kinect](#)<sup>1162</sup>.

### 17.5.3.6 TUIO TRANSMITTER

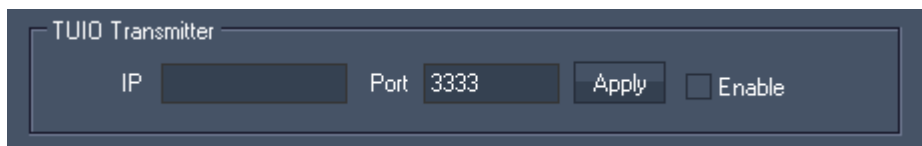

The open source protocol TUIO allows outputting the AirScan's multi touch data to other applications

This protocol is widely used around the world by many application developers and is a commonly known way to transmit the individual touches.

See a list of compatible software and operating system frameworks here:

<http://tuio.org/?software>

To use the AirScan with TUIO, set up the TUIO host IP and Port here and press [Apply]. The TUIO transmitter needs to be enabled by ticking the check box [Enable].

To start sending the AirScan's touch data, open the [AirScan Tool](#)<sup>1156</sup> and check the option [TUIO] inside the Multi Point Mode section.

### 17.5.3.7 PSN MA TRACKING SERVER

In the [Connection Manager](#)<sup>1166</sup> dialog, the section PSN MA Tracking Server allows to setup whether and how Widget Designer outputs PSN data. The PosiStageNet protocol is for example supported by MA Lighting consoles; more information can be found on [www.posistage.net](http://www.posistage.net). The data itself is generated for example in the [ID Tag Tracker node](#)<sup>1005</sup>.

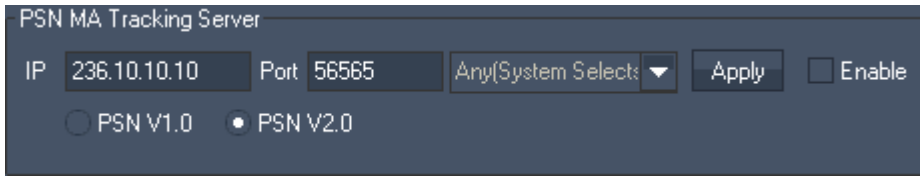

Please enter the IP address and port where to the PSN data should be send to and click "Apply". For MA Lighting consoles, the default IP is 236.10.10.10 with port 56565.

When using a Widget Designer ULT edition you may define a dedicated network adapter used for transmitting this protocol. For more information please see the [introductory chapter](#)<sup>1166</sup>.

Check "Enable" to activate the protocol in general and choose whether you like to send "PSN V1.0" or "PSN V2.0".

### 17.5.3.8 TCP CONNECTIONS

To create a new TCP connection press [Add] in the TCP section.

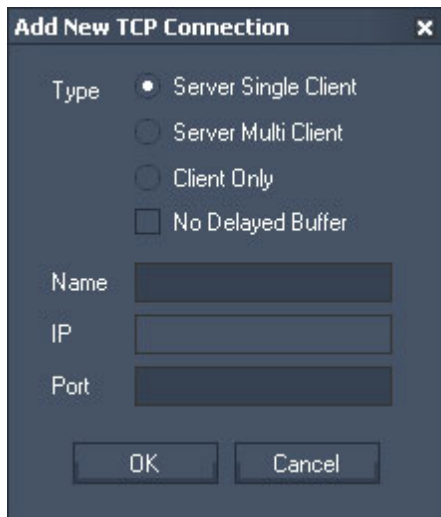

In a TCP environment a computer or device (such as a router or projector) can be set up as either Client or Server.

The reason for these two types of modes is related to the way how a connection should be established between two devices. A Server waits for incoming connections while a Client can only connect to a Server.

Widget Designer offers the option to create a connection type where Widget Designer as TCP server can receive data packets from multiple Clients at the same time.

Every time a packet is send via a Server with Multi Client the data is sent to all connected Clients at the same time.

If you need to constantly stream data via TCP output nodes, it is recommended to enable No Delayed Buffer so that the packets are not concatenated and sent immediately.

When setting up a TCP Server connection you will only need to specify the listening Port.

When creating a Client connection you will need to provide the TCP port and IP address of the TCP Server that you would like to connect to.

The Name property of the connection is only internal to the Connection Manager to let you label the connection with logical names for a better overview of multiple connections. Once the connection is created you will find the ID in the TCP list table. This ID will be required by commands and nodes to hook to this connection to either send or receive data.

After you created a TCP connection, it will be displayed in the TCP Connection list. If you do a right-click on this TCP connection, you will be able to manually Start, Stop, Edit and Test this connection. If you have a large number of connections, you may find a longer list enabling a better overview under Tools > [TCP/UDP/COM Connections](#)<sup>1176</sup> > TCP Connection.

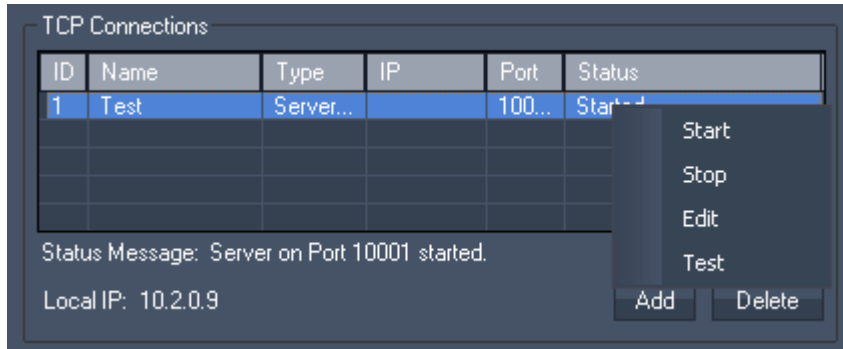

Choose "Edit" to change the Connection ID:

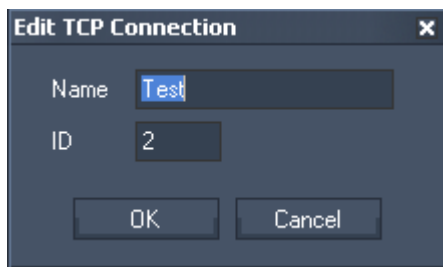

Choose "Test" and the TCP Message Tester opens. It displays the incoming UDP message as Decimal, Hex and ASCII/Symbol.

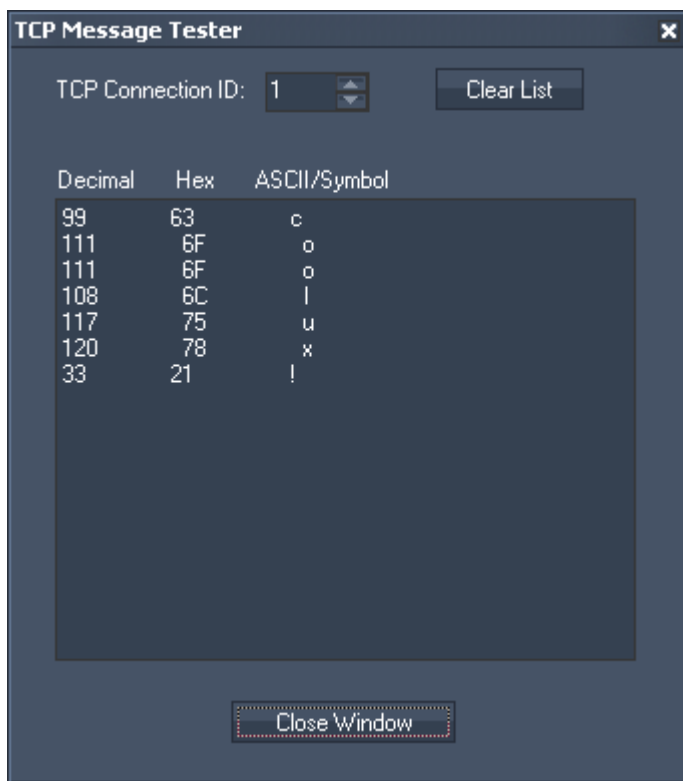

### 17.5.3.9 UDP CONNECTIONS

To create a new UDP connection press Add in the UDP section.

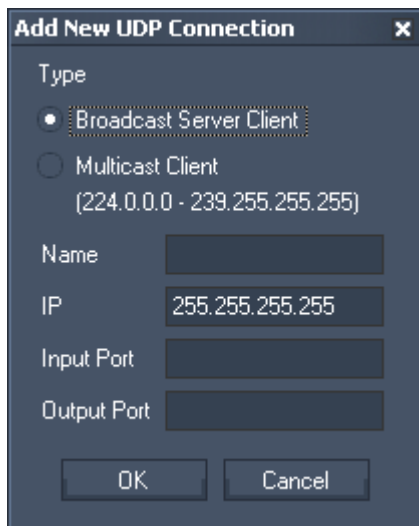

#### UDP Broadcast

The UDP connections are by default set up as broadcast connections. A UDP connection does not require a dedicated IP address or a Server to connect to (with IP 255.255.255.255 the data will be send as broadcast into the whole network).

When sending Broadcast packets to the network, all UDP receivers that listen to the sending Port of Widgets Designers UDP connection will process the packets they receive. This way a UDP connection can be used for both sending and receiving UDP packets from the network.

Please make sure to choose different Ports for Input and Output.

**UDP Unicast**

You may want to send a UDP message as Unicast to a specified destination, e.g.. to the device with the IP address 192.168.5.5. To do this, keep the type “Broadcast Server Client” but change the Broadcast IP 255.255.255.255 to the desired one.

Please make sure to choose different Ports for Input and Output.

**UDP Multicast**

In an UDP multicast there is one Master sending messages to a specified port and multicast IP (within the Multicast IP range: 224.0.0.0 – 239.255.255.255) and any Client may listen to this multicast IP.

Check “Multicast Client” to listen to a multicast IP, enter the Multicast IP (within the Multicast IP range: 224.0.0.0 – 239.255.255.255) and specify the Input Port.

There is no Output Port as only a Master is able to send messages into this IP.

The Name property of the connection is only internal to the Connection Manager to let you label the connection with logical names for a better overview of multiple connections. Once the connection is created you will find the ID in the UDP list table. This ID will be required by commands and nodes to hook to this connection to either send or receive data.

After you created a UDP connection, it will be displayed in the UDP Connection list. If you do a right-click on this UDP connection, you will be able to manually Start, Stop, Edit or Test this connection.

If you have a large number of connections, you may find a longer list enabling a better overview under Tools > TCP/UDP/COM Connections > UDP Connection.

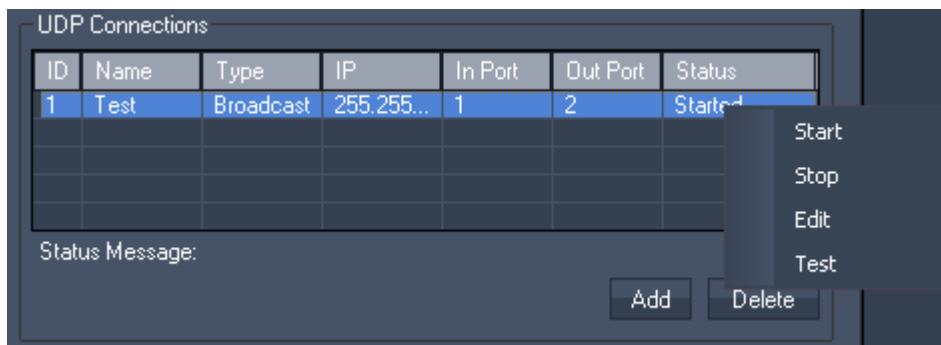

Choose “Edit” to change the Connection ID:



Choose “Test” and the UDP Message Tester opens. It displays the incoming UDP message as Decimal, Hex and ASCII/Symbol.

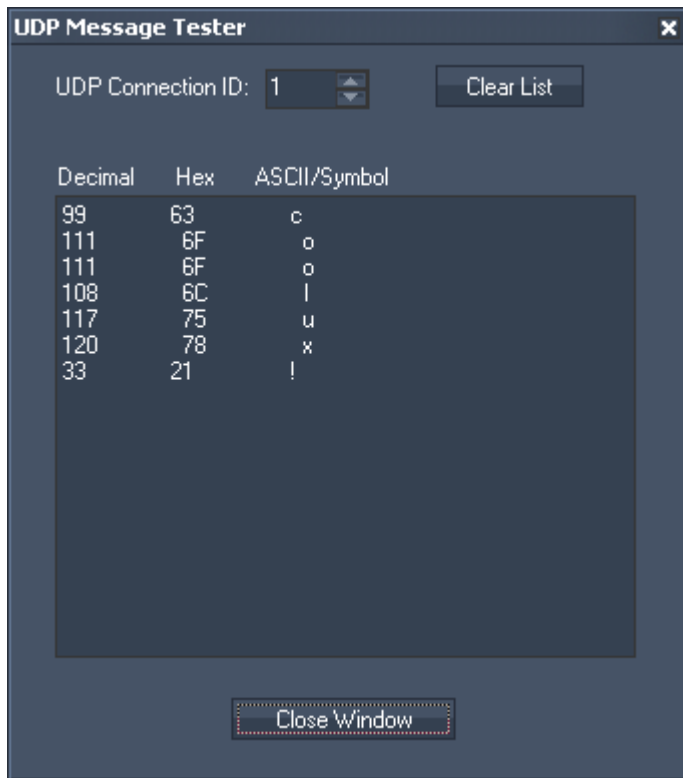

### 17.5.3.10 SERIAL COM CONNECTIONS

To create a new COM Port connection press Add in the COM section.

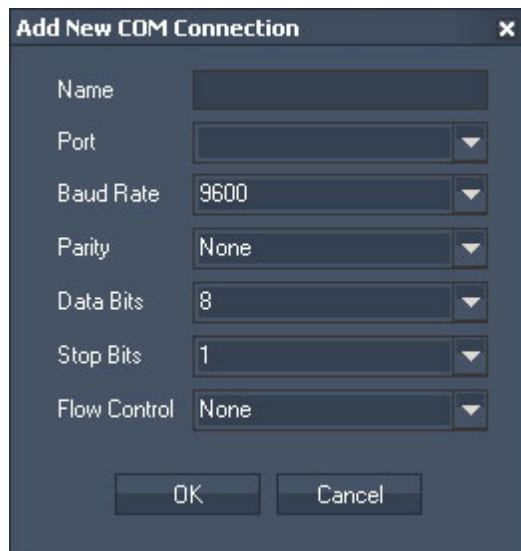

Any local Com Port will be listed in the Port drop-down list. Windows supports up to 255 comports that can be either local ports or virtual ports that are connected via network. A couple of manufacturers offer network based virtual Com Port extensions that can also be assigned here.

To setup a Com Port connection you will need to make sure that all the settings as seen above need to match the attached device settings 1:1. If the settings are not set correctly to the connected devices settings you may end up receiving corrupt or no data on this connection.

The Name property of the connection is only internal to the Connection Manager to let you label the connection with logical names for a better overview of multiple connections. Once the connection is created you will find the ID in the UDP list table. This ID will be required by commands and nodes to hook to this connection to either send or receive data.

After you created a COM connection, it will be displayed in the COM Connection list. If you do a right-click on this COM connection, you will be able to manually Start, Stop, Edit and Test this connection.

If you have a large number of connections, you may find a longer list enabling a better overview under Tools > TCP/UDP/COM Connections > COM Connection.

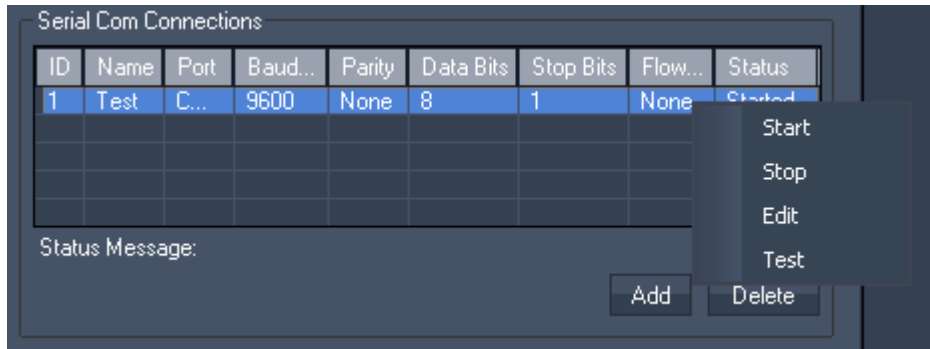

Choose "Edit" to change the Connection ID:

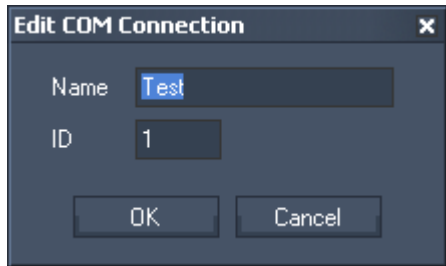

Choose "Test" and the Com Message Tester opens. It displays the incoming COM message as Decimal, Hex and ASCII/Symbol.

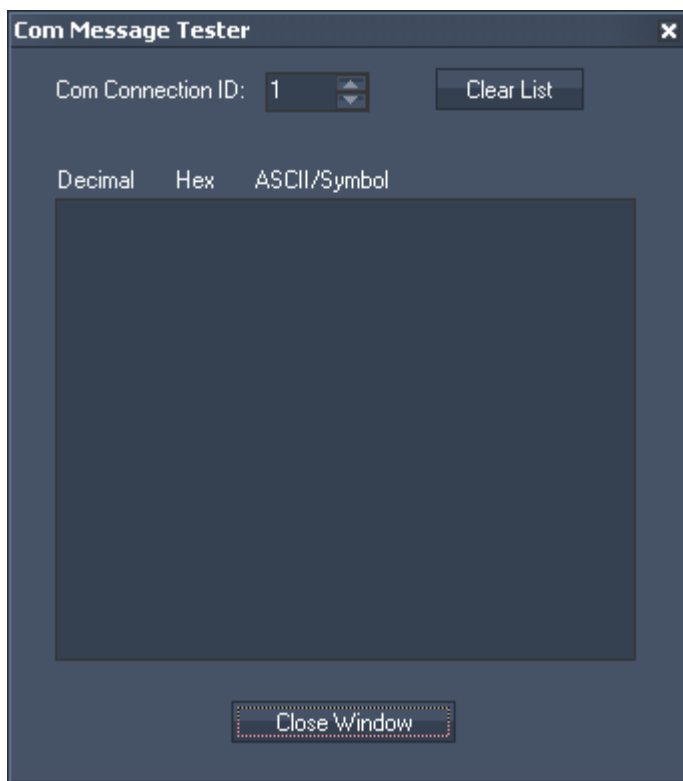

### 17.5.4 TCP/UDP/COM CONNECTIONS

The TCP, UDP and COM Port connections are all setup in a similar way as you may want to manage multiple connections to hardware or software devices via any of the three protocols. Please refer to the Connection Manager and the sub-chapters [TCP](#)<sup>1170</sup>, [UDP](#)<sup>1172</sup> & [COM](#)<sup>1174</sup> for more information. The [Connection Manager](#)<sup>1166</sup> is the tool to setup all main input and output communication protocols and includes short lists for TCP, UDP and COM connections as well.

If you like to setup or get a better overview of a larger number of connections you may open a dialog holding a longer list. Of course, all lists are synchronized.

Tools	Connection Manager		= dialog with short lists of all connections
	TCP/UDP/COM Connections	TCP Connection UDP Connection COM Connection	= dialog with a long list of TCP conn. only = dialog with a long list of UDP conn. only = dialog with a long list of COM conn. only



## 17.5.5 ART-NET MONITOR

The Art-Net Monitor can be a very useful tool if you would like to monitor Art-Net data on the network or simply find out if the DMX channels you are looking for have the right values.

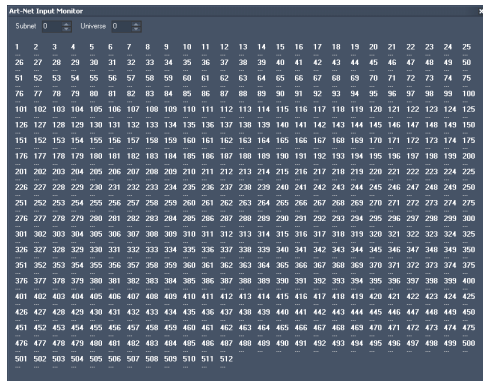

In the dialog you may select a subnet and universe. Then all channels are displayed with the according incoming Art-Net value. If you use WD to send Art-Net and you do so by broadcasting the values, you will be able to see these values in the Art-Net Monitor too. If you are unicasting the values, please switch to another Art-Net Monitor, e.g. the one in the [PB Menu](#)<sup>754</sup>. [More information](#)<sup>762</sup> about broadcast and unicast...

## 17.5.6 WEB SERVER

Since version 4 Widget Designer (WD) is able to publish its pages as html files and operates as a Web Server. Simply open your web browser and connect to the IP address and port number where the Widget Designer application runs on and view the Widget Designer page with its controls.

Please note, that for the time being, not all controls are supported as a web control too. In the Create menu, the web controls are marked with a star icon. The most important controls like Custom Script Buttons and Faders are available and can be used within the web browser in the same way as in Widget Designer. This includes of course the possibility to execute one of the 1000 commands of [WD's build-in script language](#)<sup>1254</sup>.

Please make sure to use the latest updates for your web browser. Currently Google Chrome, Mozilla Firefox, Opera, Apple Safari and Windows Internet Explorer are recommended. In fact, the default format when exporting a page as a web page is called wdm1, as it is very much based on html, web browser interpret it as such.

### Session Synchronization and Multi-Session

As soon as a user connects to the Web Server a so called session is created and he gets a session ID. A second user with another connection would create a second session and gets another ID. If your page, for example, contains a fader, there are two possible scenarios how the two users may interact with the fader:

- the page(s) and the faders are published and displayed synchronized.  
All web faders are copies or instances of the main, local WD faders; their values are always linked to each other. If a web fader is moved, it reports its value to the local fader and this one in turn to the other web instances. In other words, no matter whether the programmer moves the fader in the Widget Designer interface or a user does so in the web browser interface, everybody sees the same fader and value.  
If your project consists of several pages, every session would switch to the same page as soon as one user (or operator) calls another page.
- the page(s) and controls are published and displayed in multi-session mode (ULT only, see below)  
Each session and user has an individualized view and control setting. If one user moves the fader now,

only his fader will adopt to its individual session value. Another user might set up the fader with another session value, he is not influenced by the first user or rather the WD operator. The main Widget Designer application is able to receive, collect and evaluate all session values. For example, if the fader is used for a voting event, WD could evaluate the highest / lowest value or the average one.

Regarding the page behavior, each user can view and switch the page of choice and is not linked to the other users.

The ULT version supports even a combination of these two scenarios. If desired you may choose to have a synchronized page behavior but multi-session tool behavior.

## Web Server features in Widget Designer STD, PRO and ULT

The Web Server is a very powerful feature in Widget Designer. Its three editions: [Standard](#), [Professional](#) and [Ultimate](#)<sup>864</sup> have different implementation levels.

WD STD may publish one page to be accessed by one user. It is not possible to create a second session. If the project consists of several pages, you may decide which one should be published, it does not necessarily need to be the "Default" page.

WD PRO may publish an unlimited number of pages to be accessed by an unlimited number of users at the same time. If the project consists of several pages, you may decide which one should be published as the index page - the one you will be automatically redirected to, when connecting to a web server. It is not possible to create a multi-session, all sessions are synchronized. Thus, all users will have access to the same page and its controls simultaneously.

WD ULT may publish an unlimited number of pages to be accessed by an unlimited number of users at the same time. If the project consists of several pages, again, you may decide which one should be published as the index page. In addition you may decide whether all sessions should be synchronized or whether a multi-session should be supported which will allow simultaneous as well as individual setups. In individual setups each user can see a different page and in addition multi-session controls like Faders and Custom Script Buttons may have deviating values.

## How to use the Web Sever?

In the main menu bar: Click on Tools > Web Server

Using the context menu: right-click somewhere in the empty main background and choose Tools > Web Server.

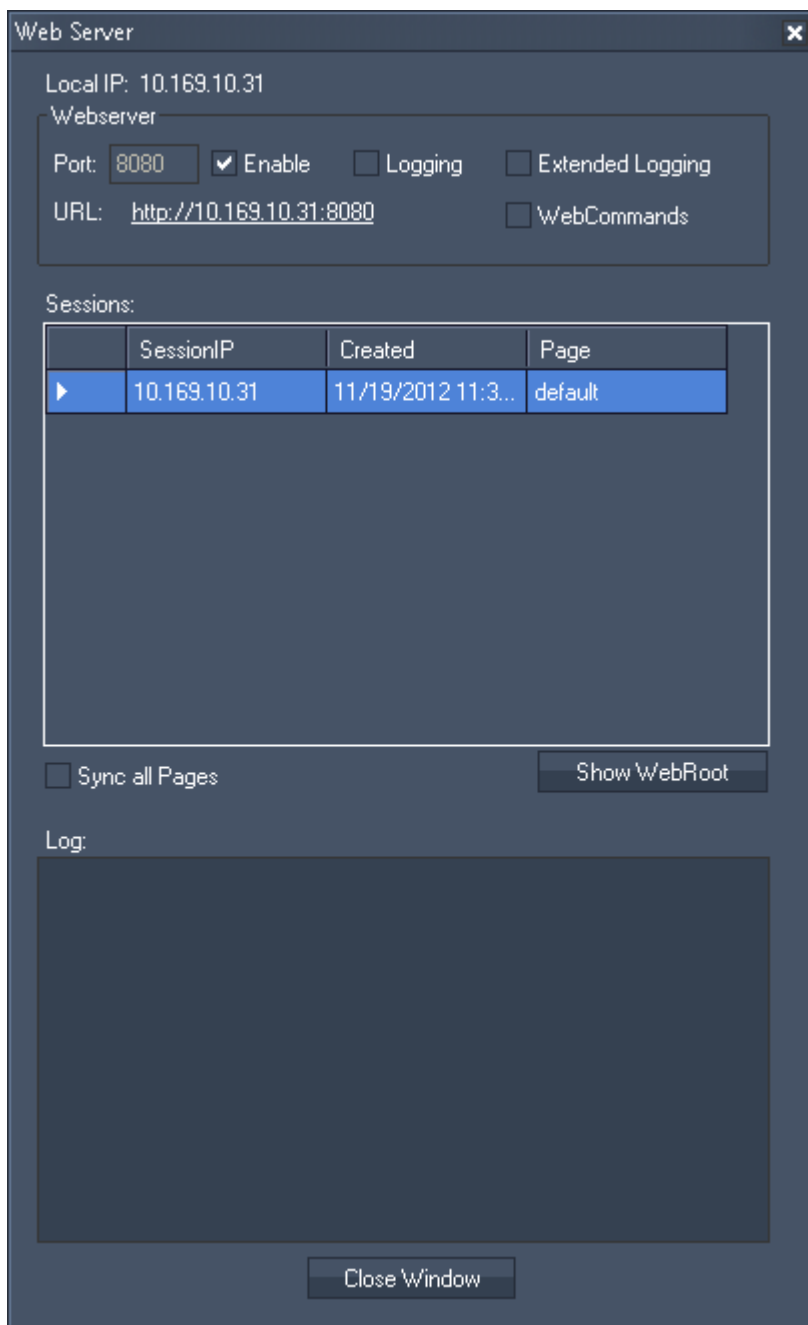

Tick the check box "Enable". On your local PC you may try the link seen below. For other PCs in the network, open a web browser and enter "http://" then the IP address where the Widget Designer application runs on, then ":" and the port number. In the depicted example it would be <http://10.169.10.31:8080>. The index page is called automatically, in this case it is <http://10.169.10.31:8080/default.wdml> .

If you like to use the feature not only within a local area network (LAN), you may do so as well. First of all your router must be set up to allow access on the chosen port. Then it must be configured to forward this wide area network (WAN) request to the specific Widget Designer IP address within your local area network (LAN). Now you may enter your IP address and again the port number. If you like to use the feature for a longer period keep in mind that you might not have a static IP address. Most providers assign a deviating IP address every 24h, thus you have a dynamic IP address. In that case, a ddns service (dynamic domain name system, e.g. [dyndns.org](http://dyndns.org)) is very useful. The system

provides a persistent domain name and points to a changing, dynamic IP address on the internet. Your router must support ddns in order to update the system's database.

The check boxes for (Extended) Logging influence the information the Log text field below shows.

The check box "Web Commands" opens a HTTP query string listener. The HTTP listener allows you to use a link to send commands from a web instance directly to Widget Designer. See here all [commands](#)

Use this syntax: [http://WD\\_IP\\_Address'?\(Commandstring\)](http://WD_IP_Address'?(Commandstring))  
 For example: [http://192.168.1.20'?\(FaderUp.2.1\)](http://192.168.1.20'?(FaderUp.2.1))

The check box "Sync all Pages" will synchronize the viewed page for the main Widget and its web instances.

"Show WebRoot" opens the path in Windows Explorer whereto all JavaScript functions, libraries and methods are saved. They are needed to give a web fader the same interactivity and behavior as a WD fader has. The folder is located in the installation path, e.g.:  
 C:\Program Files (x86)\coolux\Widget Designer ULT 4.0 Rev 406\Data\web\_root\...  
 Please note, that the Web Server creates the wdml pages dynamically on the fly, they are not saved anywhere. If you like to influence the page's design or behavior, please read the information below about page settings.

The log text field lists for example whether a new session has connected to the Web Server as well as the current count of all session. In addition it may list whether errors have occurred, e.g. an image was not able to be loaded.

If you like to have a different WD page than "Default" as the starting page, switch to this page and edit the settings. Either right-click somewhere in the empty main background and choose Edit Page or open the edit menu in the main menu bar and choose the command there. At the bottom of the Edit Page dialog tick the check box "Index Page".

If you like to exclude pages from the web access, uncheck the box "Publish as Webpage".

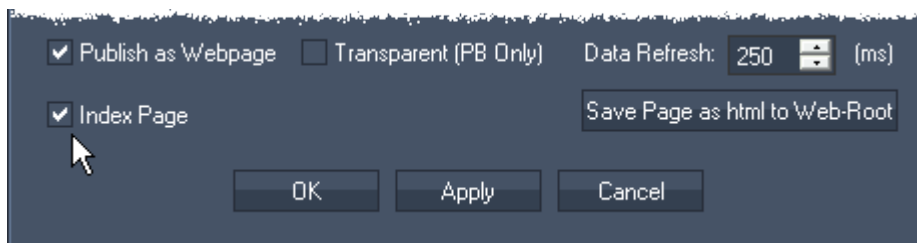

The Data Refresh time influences the interval at which the Web Server sends and receives data. If it is set too high, the web pages will not be updated as fast. If it is set too low, the transmission rate increases and requires a better connection.

### Influencing the web site design - advanced users

"Save Page as html to Web-Root" exports the entire page with all of its controls as an html file. If you are familiar with html and JavaScript programming you may edit it yourself to suit your needs regarding design and functionality, or you task a web designer with it. The web root folder can be found in the folder where you saved the project, e.g.:

C:\coolux\projects WD\test web server\Data\web\_root\Default.html

If you add JavaScript functions and methods to your site or if you exchange images, save all resources in the project's web\_root folder.

If you now enter the address <http://10.169.10.31:8080/default.html> the web browser will connect to the Widget Designer Web Server who calls the information for the custom changes from the project path. Still, it will load the Widget Designer functionality (e.g. fader behavior written as a JavaScript function)

from the installation path, the program's web\_root folder. Thus Widget Designer will still be able to read out the session value from your customized fader.

You may as well influence web pages without saving them as a static html site. In the web\_root folder in the installation folder itself there is a file called WD\_Header.incl. Among others, this file defines how the dynamically created wdm1 pages look like.

If you for example have an iPad and you like to use web sites in the Safari Browser without seeing the taskbar, you can copy the following line into the incl file

```
<meta name="apple-mobile-web-app-capable" content="yes">
```

## Visual and technical differences between the interfaces in Widget Designer and web browser

First of all, the appearance might be different. Whilst Widget Designer supports Z-order when controls or nodes are arranged overlaying each other, most web browsers do not. There, an overlaying control is transparent in some parts and thus the underlying control can be seen, whereas in WD you would change the Z-order to bring the designated control in front of the other and cover it. In other words, in WD transparency can be only assigned against the background, not against other controls or nodes.

Technically, it is very important to understand that all nodes, tools and all controls "live" in the Widget Designer. The web browser interface is a second interface, it represents what is set up in the main WD interface, it can be seen as an instance or copy of it.

Only the WD itself gives you the possibility to create new elements and to change their Item Properties. For example, if you create a fader in WD, the browser adopts and displays a fader too. If you like to change its look or value range, do so in Widget Designer and it will send the new properties to the web instances. So, the look of every interface will always be the same and a control's Item Properties always match.

A control can be actually used in both interfaces. The most important controls: Custom Script Buttons, Faders, and Textboxes are able to be multi-session controls. All others are always synched. For example, you may change the fader's value by dragging its handle either in WD or in the web browser. Depending on the setting to have a synchronized session or a multi-session, the other web copies of the fader will update too and move automatically to the new value; or in case of a multi-session setup, they can be only moved in the local interface. That means that a fader can not only hold one value but several ones and each web instance shows the same fader but with a different value, its own session value.

### **In a nutshell, the controls' properties are identical, but their values can be separately customized.**

A command only works in the Widget Designer application and is executed there. You may send a command, either from within the WD or a browser but it only affects the control in WD. For example, if you send "WDFaderUp,ID,Seconds" only the local WD Fader will actually do the fade. Of course, if you have a synchronized session, all web faders will fade too. This is not the case when having a multi-session as the session faders are now detached. Importantly, if you send a command that alters the appearance of a control, e.g. the color of a Custom Script Button (WDCustomScriptTint,ID,Red,Green,Blue) again, this alters the local button and as the Item Properties always match, all other web buttons will be tinted in that color too.

A node can be displayed and used in WD only and similarly to commands, it works up local values.

As mentioned above, controls can be multi-session controls and have their own so called session value. Controls, pages and variables may have session values. It is possible to read these out and evaluate them or to process them in commands or variables. Please read the topic "[Member and Session Values](#)" <sup>1196</sup> if you are interested in that feature.

### 17.5.7 REMOTING

The Remoting Tool allows you to setup a TCP/IP Server (single client or multi client), UDP and HTTP-Listener, the iPhone WD Remote and a Serial Input without using the Connection Manager and nodes for incoming communication.

Any incoming data will directly be executed as a [command](#)<sup>1254</sup> when the syntax of WD commands is used. The command must be put in parentheses, e.g. (WDFaderUp, 1, 2).

The messages received will be displayed in the message log.

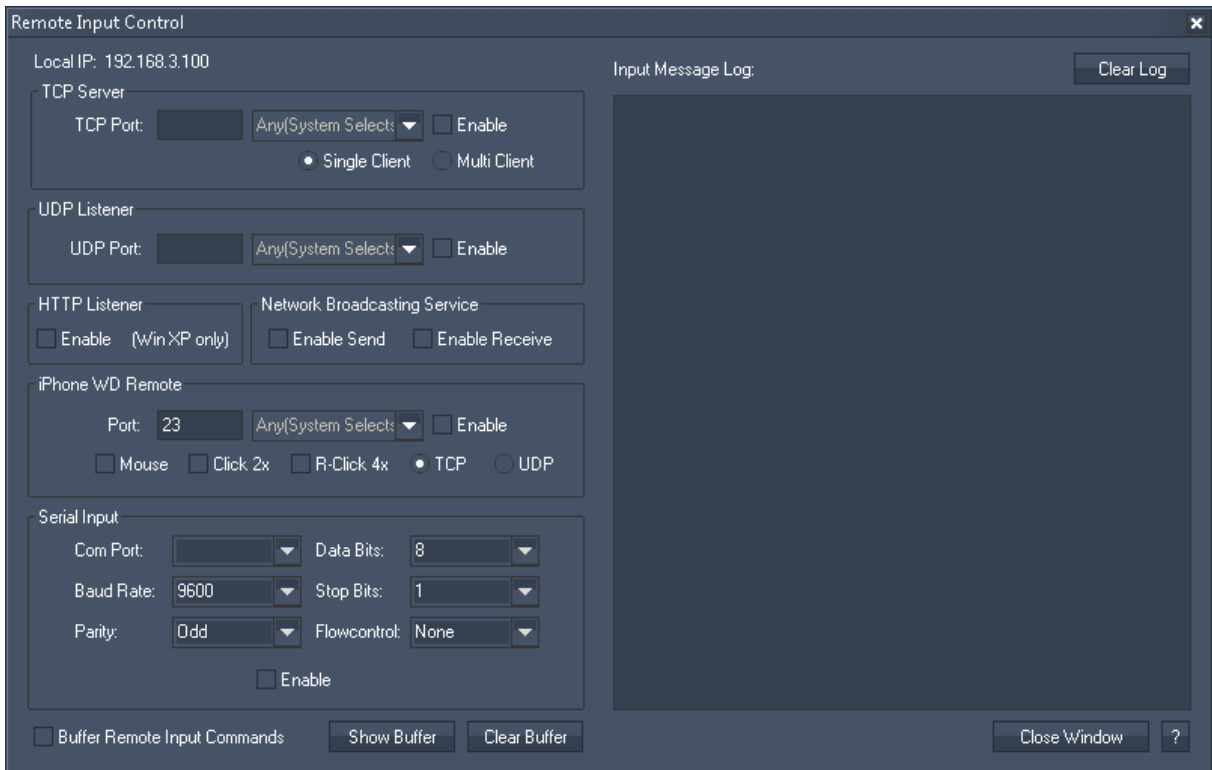

Please see the following topics for further information:

[TCP Server](#)<sup>1183</sup>

[UDP Listener](#)<sup>1183</sup>

[HTTP Listener](#)<sup>1183</sup>

[Network Broadcasting Service](#)

[iPhone WD Remote](#)<sup>1185</sup> and

[Serial Input](#)<sup>1187</sup>

### 17.5.7.1 TCP SERVER

In a TCP environment a computer or device (such as a router or projector) can be set up as either Client or Server.

The reason for these two types of modes is related to the way how a connection should be established between two devices. A Server waits for incoming connections while a Client can only connect to a Server.

The Remoting Tool in Widget Designer offers the option to create a connection type where Widget Designer as TCP server can receive data packets from multiple Clients at the same time.

TCP Port:

When setting up a TCP Server connection you will need to specify the listening TCP port.

Single Client / Multi Client:

Choose if you want to establish a connection to only one client or if you want to allow multi clients to connect to your TCP server.

Press [Enable] to start the TCP Server.

### 17.5.7.2 UDP LISTENER

The UDP connection is by default set up as broadcast connection. An UDP connection does not require a dedicated IP address or a Server to connect to.

When setting up a UDP Listener connection you will only need to specify the listening Port. Press [Enable] to start the UDP Server.

### 17.5.7.3 HTTP LISTENER

The HTTP Listener allows you to use a web browser or link to send commands to Widget Designer.

Use this syntax:

`http://WD_IP_Address'?(Commandstring)`

Example:

`http://192.168.1.20'?(FaderUp,2,2000)`

iPhone WD Remote (available soon)

Use the Coolux iPhone App (not released yet) to connect via TCP or UDP to the Widget Designer. Enter the same port that is set up in the iPhone and check [Enable].

Rev 12

- HTTP Querystring listener built-in.

This means you can use a web browser or link to send commands as well ex:

`http://192.168.0.141'?(Commandstring)`

- Comport Input Support

- All Inputs TCP/UDP/HTTP/COM can send input messages asynchronously

- multiple commands can be send in one message

---

#### 17.5.7.4 NETWORK BROADCASTING SERVICE

This section in the Remoting dialog of Widget Designer, Network Broadcasting Service (NBS), allows to transmit and update [Labels](#)<sup>931</sup>, [Faders](#)<sup>925</sup> and [Custom Script Buttons](#)<sup>884</sup> across multiple WD Designer instances on the network.

Please check the according options to enable/disable the Widget Designer to Send or Receive Network Broadcasting data.



### 17.5.7.5 IPHONE WD REMOTE

#### Features of the App

The free "Widget Designer Remote" App for Apple devices such as the iPhone, the iPad or iPod allows to remote control a running Widget Designer with your mobile device. You may send

- single or multi-touch data to remote control the mouse or work directly in various controls such as the "[Multi Touch Panel](#)"<sup>936</sup>
- commands to execute a certain function, either by clicking a button or via a text field
- images taken with your mobile device
- acceleration data from the in-built accelerometer, e.g. to track an object

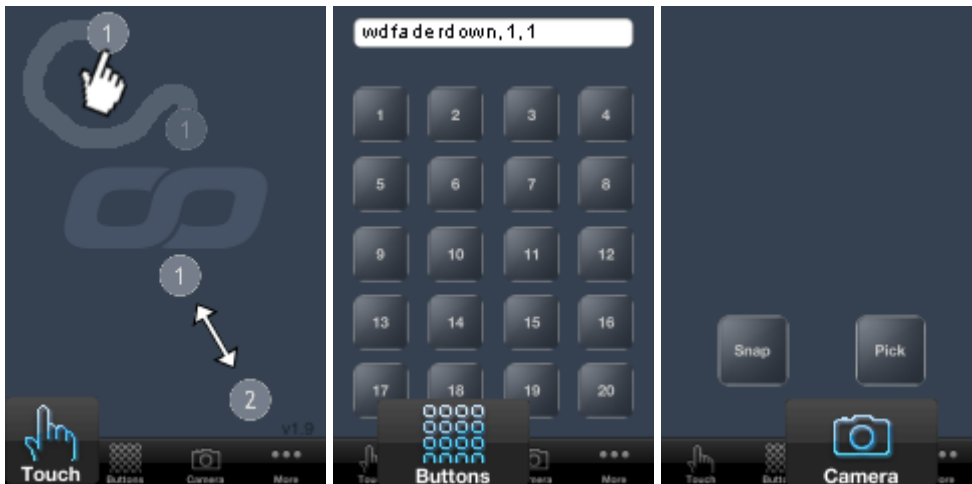

It might be of interest that Widget Designer offers another feature to be remote controlled by mobile devices. The in-built [Web Server](#)<sup>1177</sup> is capable to export any page as a page that can be viewed by any web browser such as Safari.

#### Settings within the device



After downloading and installing the App, please open the "Settings" menu. Under "Wi-Fi", make sure that you share the same wireless network as the PC Widget Designer is running on. Afterwards, scroll down the "Settings" list and search for "coolux", here you may set up the optional settings for this App.

**Protocol:**

Choose the connection type: TCP or UDP. For sending touch and tracking data, UDP is the better choice - for the button and command data TCP is more reliable. If you like to use the camera mode, TCP must be used. Please see [this chapter](#)<sup>1541</sup> for detailed info about these two protocols.

**IP Address:**

Enter the IP address from Widget Designer. If you are not sure, have a look into the dialog "[Pandoras Box IP Configuration](#)"<sup>865</sup>.

**Port:**

Enter the listening port for the TCP or UDP connection. The same port needs to be set in Widget Designer, per default it is already set to 23.

**Accelerometer:**

Enable this option if you like to transmit XYZ acceleration values.

**Button Settings:**

Per default all buttons are labeled with the numbers 1-20. Enter a new name to change this. In the "Script" field, a command can be allocated to each button. It is mandatory to enclose the command in parentheses. It does not matter whether it is written in capitals or lower-cased. Please refer to the [command list](#)<sup>1260</sup> for more details.

Please note that you can enter a command in the App itself as well. The buttons screen includes a text field, when clicking into it you may enter a command without parentheses and click "Send" on the keyboard. If you like to send more than one command at once, you can either send one command that executes a macro or clicks a Custom Script Button that holds these commands. Both, the macro and the Custom Script Button need to be set up in Widget Designer.

If you are using iOS 5 and encounter problems with the App, please update to a newer operating system, e.g. iOS 6; so far no problems were reported with that version.

**Settings within Widget Designer**

Go to the Tools menu and open the "Remoting" dialog. The section "iPhone WD Remote" offers the following settings.

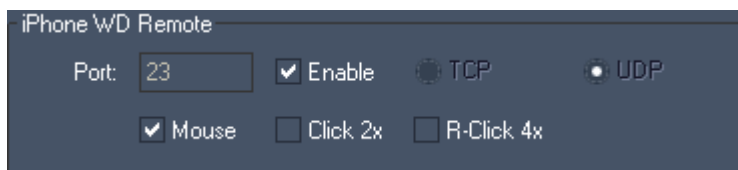
**Port:**

Enter the listening port for the TCP or UDP connection. The same port needs to be set in the settings for the App, per default it is already set to 23.

**TCP / UDP:**

Decide which protocol you like to use, again it needs to be the same as set in the App. For more details, see the above.

**Enable:**

Tick the check box to enable the connection.

**Mouse:**

This option allows to remote control the position of the mouse cursor with the touch data from the WD Remote App user interface. Regardless of that setting many controls like the "[Multi Touch Panel](#)"<sup>936</sup> allow to enable the input mode "iPhone" to receive the touch data.

**Click 2x:**

This option allows receiving a mouse click when the WD Remote App user interface is touched twice.

**Click 4x:**

This option allows receiving a mouse right-click when the WD Remote App user interface is touched four times in a row.

If you wish to work with the acceleration values, please create an input node: Input > Device > [iPhone Remote](#)<sup>1030</sup>.

If you like to use the camera mode, please follow these steps. First, pick an image using the App and send it to Widget Designer. It then appears in the [Image Resource Manager](#)<sup>1249</sup> under Style: User, Control: User. With the help of commands, you may then display it in the Image / Picture Box, use it on a Custom Script Button or save it directly on the hard drive before adding it to your Pandoras Box project. The commands including "Recent" refer to the last image send from the App.

Some helpful commands could be:

- [WDCustomScriptImageResource.ID.ResourceName](#)<sup>1260</sup>
- [WDImageLoadResource.ID.Resource](#)<sup>1341</sup>
- [WDImageLoadRecentResource.ID](#)<sup>1342</sup>
- [WDResourceSave.Resource.Path](#)<sup>1260</sup>
- [WDResourceRecentSave.Path](#)<sup>1260</sup>
- [ResourceAddFileFromLocal.Path](#)<sup>1282</sup>

### 17.5.7.6 SERIAL INPUT

Any local Com Port will be listed in the Port drop-down list. Windows supports up to 255 comports that can be either local ports or virtual ports that are connected via network. A couple of manufacturers offer network based virtual Com Port extensions that can also be assigned here.

To setup a Com Port connection you will need to make sure that all the settings as seen above need to match the attached device settings 1:1. If the settings are not set correctly to the connected devices settings you may end up receiving corrupt or no data on this connection.

### 17.5.8 EVENTS

The Event Editor allows you to execute commands at a certain time or repeated in a certain time interval.

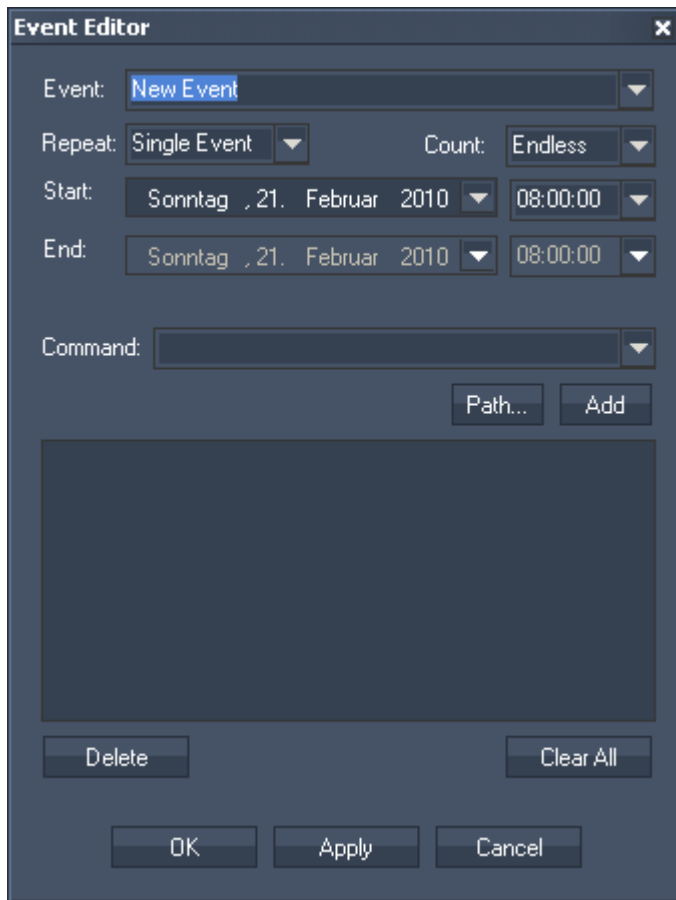

Enter the Event's name in the Event text field or choose an existing Event from the list to view and edit it.

Set up the Repeat option. Choose a Single Event or a repeat time interval: every minute, hour, day, week, month or year.

If the Count should end at a certain time, please choose "End Date" from the Count list. Then the End Date lists will be enabled.

Choose a Start date from the calendar list and the start time. If you need a start time that differs from the options in the time list, please enter it manually.

If the Count has an End Date, please also choose end date and time from the list below.

In the Script section you may enter commands to be executed. You may use the drop-down list and the "Add" button or type directly in the text field. The topic [Script Language](#)<sup>1254</sup> explains this in more detail. To delete a single command, select it and click on [Delete]. To clear the entire script from the script text box, press [Clear All].

### 17.5.9 FUNCTIONS

The Function Editor lets you store a series of commands comparable to a [Macro](#)<sup>1191</sup>. In difference to a Macro, a Function can include variable parameters that can be changed easily and any time when calling the function to be executed. In other words, a function is a sub routine with input variables that allow dynamic programming.

Using functions is helpful when the same series of commands should be called from different places especially when the same command structure should be executed but its effect should be adjusted flexibly. Functions save time entering and editing commands.

Functions also have the power to run as so called blocking functions, this is explained below the general explanation how a function itself is set up and called i.e. used.

#### Setting up a function

To open the Function Editor go to "Tools" and "Functions". An exemplary function is depicted below). Enter a function name with arguments (the colored placeholders within curly brackets) and then the function text itself referring to these arguments.

Always click "Apply" to save the function or changes you made in it.

In the Script section you may enter commands to be executed. You may use the drop-down list and the "Add" button or type directly in the text field. The topic [Script Language](#)<sup>1254</sup> explains this in more detail.

See here a list of all [commands](#)<sup>1254</sup>.

You can also use [Macros](#)<sup>1191</sup>, [Variables](#)<sup>1193</sup> and other [programming statements](#)<sup>1430</sup> e.g. an [If-clause](#)<sup>1430</sup>.

You can also call other functions but it is not recommended to call the same Function recursively as you might create a deadlock!

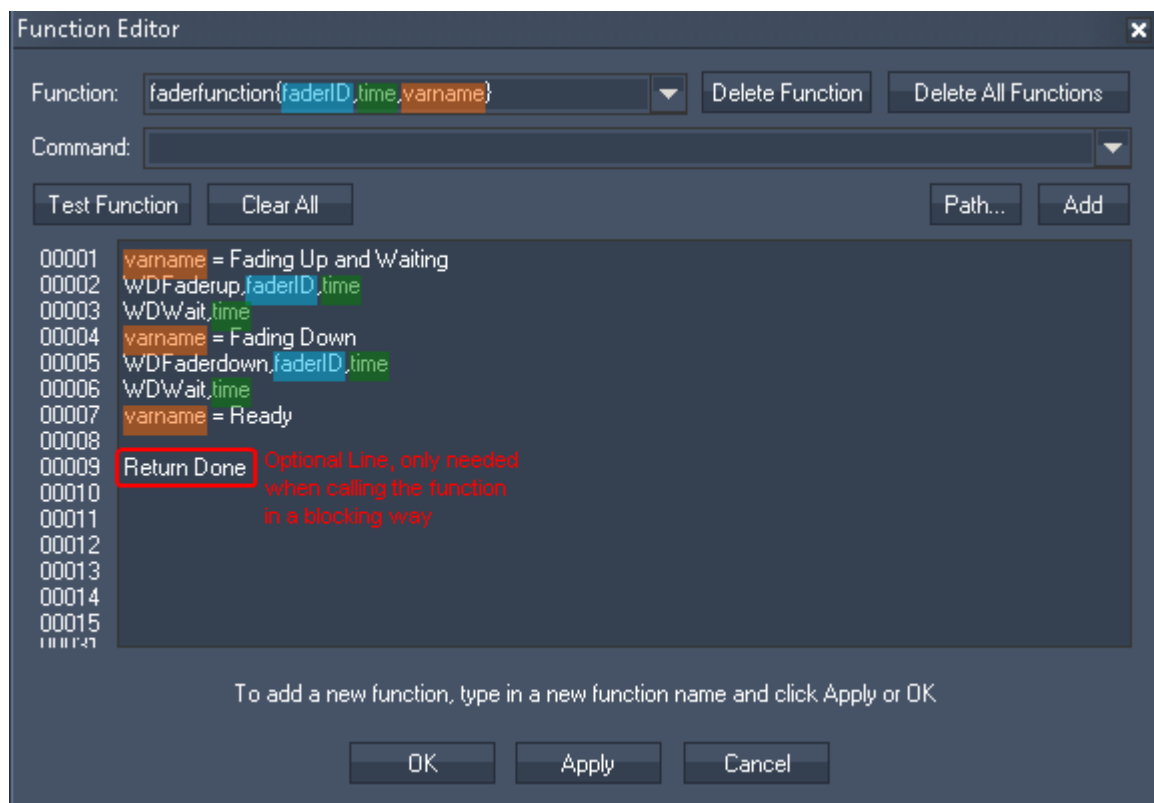

With the drop-down list you can access other functions. If you like to clear the entire script from a function to start over, click the button "Clear All". If you like to erase the entire function incl. its name, click on "Delete Function".

### Calling a function (asynchronously and in blocking mode)

To test a function, you can click on the Button "Test Function". Substitute the arguments / variable inputs with the according number or name and click "Test". In the same way a function can be called with a [Custom Script Button](#)<sup>884</sup>, a [Macro](#)<sup>1191</sup>, or anything else that can execute a command.

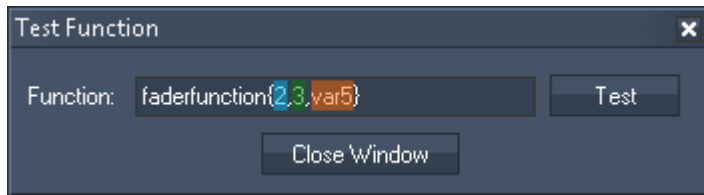

By calling a function, it automatically searches for arguments inside the function text and replaces them with the given arguments / inputs. As an example, the above function used the command `WDFaderup,faderID,time` with the two arguments: "faderID" and "time". Whenever calling this function, you can decide what should be used as "faderID" and what as "time". In the example from the Function Tester or the blue button the "faderID" is 2 as it is mentioned as the first argument; "time" is replaced with the number 3. The purple button calls the exact same function but here "faderID" is 4 and "time" is 1.

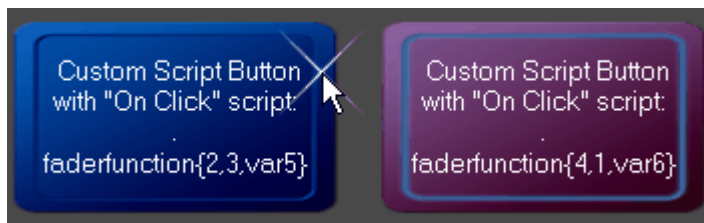

The general execution of the function, when being called like above, will happen as every other script from within a Custom Script Button or Macro. It is executed in a so called asynchronous or parallel way. Whilst the function is processed, the GUI is still updated, meaning that Faders fade, Labels change their text, parameters from the node system adopt to new values and update values that are send out, etc. If a Macro consists of two commands, the first calls the function and the second executes something else, the second command runs parallel to the function.

This default, asynchronous, non-blocking mode is always used when a function is used as single statement without having a return statement itself or without its return value being assigned.

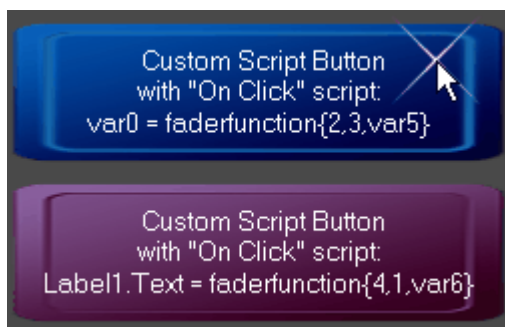

Alternatively, a function can also be called in a blocking mode. To do so, the function must end with a Return statement, a line that says "Return" and "something". In other programming languages this is known as the "Result" from a sub routine. If now the function is called by writing the result / return value into a Variable, Label, etc. the main GUI thread will suspend until the result / return value of the function is reached.

If clicking the blue button with the "On Click" Script `var0 = faderfunction{2,3,var5}`, the GUI and output values are not updated until the Variable "var0" says "something" (what you have defined as the Result value.

Please note: When using "WDWait" commands inside of blocking functions, this may affect the entire processing of the Widget Designer during runtime.

### Additional example for a function

This example shows how a function can be used to compare two numbers and return the higher number so that it can be used for displaying it in a Label and fading an according Fader.

Function name	<code>max{num1,num2}</code>
Function script	<pre>If num1 &gt; num2 { varResult = num1 } Else { varResult = num2 }</pre>
Calling script	<pre>max{5,3} Label6.Text = varResult WDFaderUp,varResult,2</pre>

### 17.5.10 MACRO

The Macro Editor lets you store any command(s) into a single macro. Using macros is very helpful when a command combination is called in several controls. You will save time entering and editing each command.

Enter the name for a new macro or choose an existing one from the list.

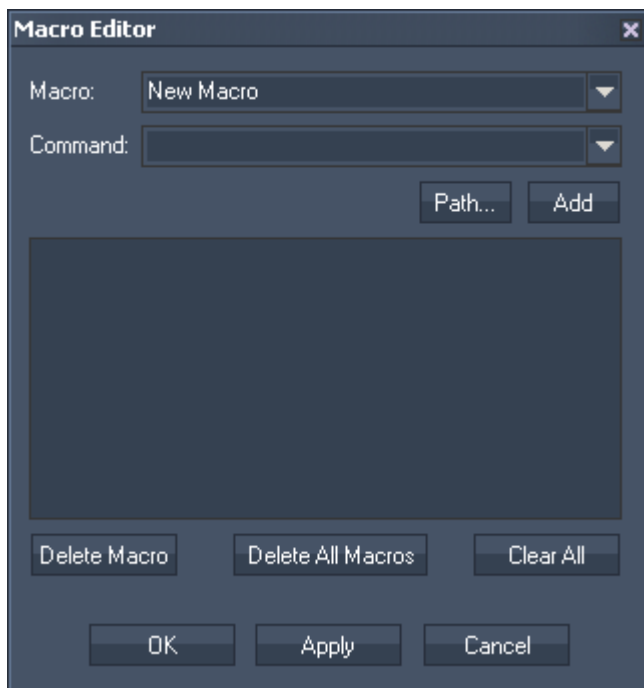

In the Script section you may enter commands to be executed. You may use the drop-down list and the "Add" button or type directly in the text field. The topic [Script Language](#)<sup>1254</sup> explains this in more detail. See here a list of all [commands](#)<sup>1254</sup>.

To delete a macro, choose it from the drop-down list and press [Delete Macro], to delete all macros press [Delete All Macros]. To clear all commands assigned to a macro, press [Clear All].

---

Please be aware that if you recursively call the same Macro from its own command you might create a deadlock and Widget Designer might stop responding.  
It is recommended not to use recursive Macros even though there are no boundaries in Widget Designer to prevent you from doing this.

To call a Macro from e.g. a Custom Script Button, use this command:  
[WDMacro.'MacroName'](#)<sup>1346</sup>



## 17.5.11 VARIABLES

Variables are a powerful feature in Widget Designer. Any value can be stored within a variable and be called from another control or node or command. Variables can hold one (or more) variable value(s) that update automatically or they can hold one (or more) constant value(s).

### How to create variables?

The PRO and ULT version of the Widget Designer include a (below depicted) tool called "Variable List". It allows viewing all existing variables, their type and value. Right-click anywhere in the empty main background and choose Tools > Variables or use the main menu bar to call it.

The STD version does not include the Variable List though it supports variables.

First of all, a variable needs to be declared. You may use the right-click menu within the Variable List or [these commands](#)<sup>1385</sup> to do so. Commands are also interesting in the further workflow e.g. calling and editing a variable, particularly array variables.

When you create the variable decide what type, name and (starting) value it should have. Please note that the name must not start with a space nor include the characters for "point" and "comma" and others: . , - + = / \ ( ) [ ] { }

String	Ex. 1:	hello
= ASCII text	Ex. 2:	image5.png
	Ex. 3:	c:\folder\subfolder
String Array	Ex. 1:	surname   forename
= string variable consisting of several elements	Ex. 2:	x-coordinate   y-coordinate   z-coordinate
Double	Ex. 1:	-5.567
= number with decimal places	Ex. 2:	12.123456789
	Ex. 3:	99999.9
Double Array	Ex. 1:	-5.12   -2.9   10.456
Integer	Ex. 1:	-50
= number without decimal places	Ex. 2:	0
	Ex. 3:	51347
Integer Array	Ex. 1:	-50   12   159

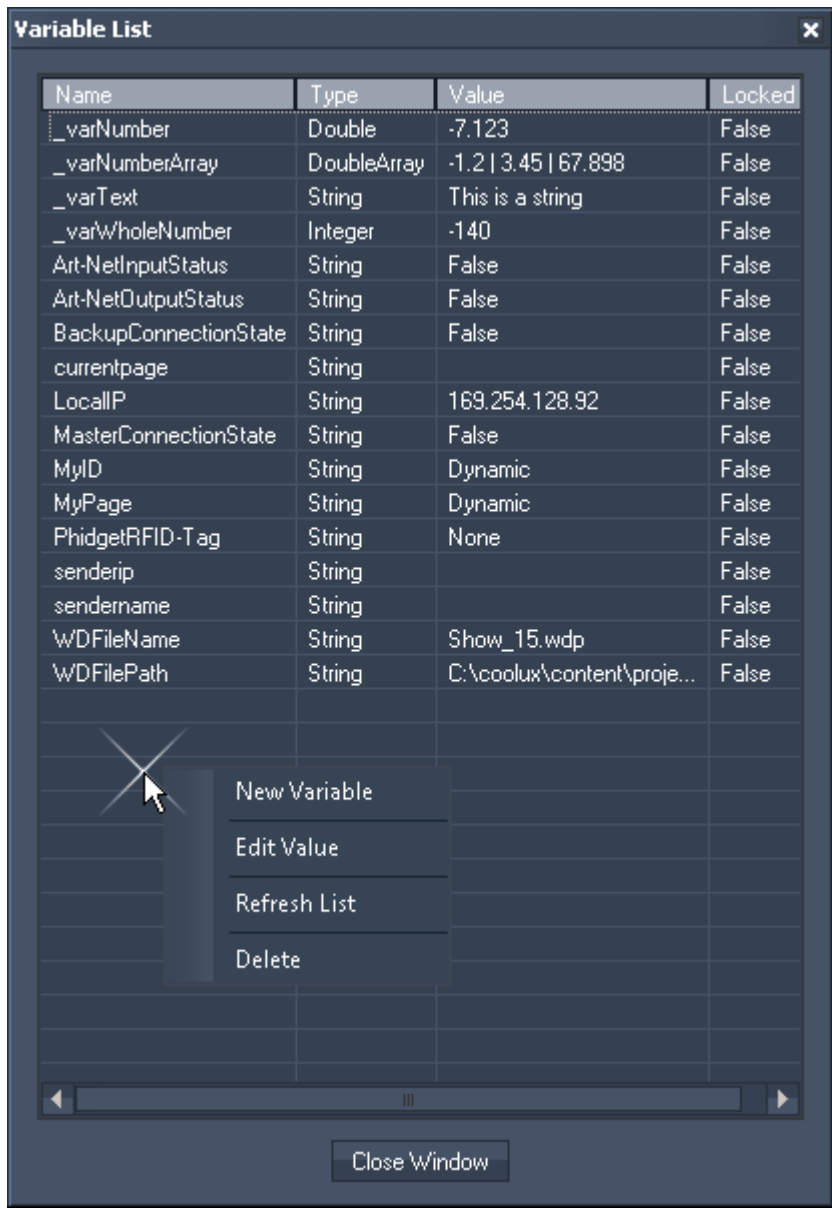

If you open the Variable List the first time, you will see that there are already some variables. These system variables are called internal variables and are created per default, update automatically and can not be deleted.

The variables "MyID" and "MyPage" are dynamic variables, you may substitute arguments from a command with them. As soon as this command is executed, the dynamic variable is assigned with the according value. For instance, there is the command

```
WDCustomScriptTextColour, ID, R, G, B. You may write
```

```
WDCustomScriptTextColour, MyID, 0, 0, 255 into the Custom Script Button with ID 1 as well as into the one with ID 2. Both buttons will be colored blue as soon as they are clicked. If you click the first CS Button, MyID is assigned with 1, if you click the second button, the same variable is assigned with 2.
```

The depicted variables not holding a value only do so when the Web Server is started and a web session is connected.

Internal Variable also exist in the STD version.

The 4 additional variables starting with "\_var" were declared by the user.

**How to assign another value to a variable?**

After having declared a variable it can adopt a different value at any time. Obviously the new value must be of the same type. For assigning a new value, there are three ways: use the right-click menu in the Variable List, a node or commands.

The Variable Output Node can be found under Nodes > Output > Generic and can be linked to a filter or input node in order to use their value as the new variable value. If you are not familiar with nodes, please

click [here](#)<sup>959</sup>. The output node updates the variable constantly with a new value. An example is depicted below.

There are very fast commands like `Variable = Value` to assign a new (member) value. This is also called a direct command, in difference to common commands, they are more direct, fast and flexible. Please see the below table for possibilities to assign new values to variables. Commands are listed in the [command list](#)<sup>1386</sup>, and more information about the way to write commands is described in the chapter "[Script Language](#)"<sup>1254</sup>.

direct command	corresponding common command
<code>Variable = Value</code>	<code>VValue, VarName, Value</code>
<code>varNumber = 123</code>	<code>VValue, varNumber, 123</code>
<code>varString = Hello</code>	<code>VValue, varString, Hello</code>
<code>ArrayVariable[Index] = Value</code>	<code>VSetArrayValue, VarName, Index, Value</code>
<code>varArray[5] = 123</code>	<code>VSetArrayValue, varArray, 5, 123</code>
<code>Variable = Variable</code>	<code>VValue, VarName, Variable</code>
<code>varNumber1 = varNumber2</code>	<code>VValue, varNumber, varNumber2</code>
<code>varString1 = varString2</code>	<code>VValue, varString, varString2</code>
<code>varArray[5] = varNumber</code>	<code>VSetArrayValue, varArray, 5, varNumber</code>
<code>varArray[varNumber] = 5</code>	<code>VSetArrayValue, varArray, varNumber, 5</code>
<code>Variable = MemberID.MemberValue</code>	<code>VValue, VarName, MemberID.MemberValue</code>
<code>varNumber = fader2.value</code>	<code>VValue, varNumber, fader2.value</code>
<code>varString = labell1.text</code>	<code>VValue, varString, labell1.text</code>
<code>varArray[varNumber] = fader2.value</code>	<code>VSetArrayValue, varArray, varNumber, fader2.value</code>
<code>varArray[fader2.value] = varNumber</code>	<code>VSetArrayValue, varArray, labell1.text, varNumber</code>
<code>varArray[labell1.text] = varNumber</code>	
<code>(if label holds numeric value!)</code>	

Member values are explained in the [following chapter](#)<sup>1196</sup>.

There are also commands like `Variable += 1`, that adds 1 to the current value of the variable. `Variable = (1+2*3)` even does a complex mathematical calculation for you. More of these advanced variable assignments can be found in the chapter [Math Expression](#)<sup>1199</sup>.

There are many ways to draw a value from another control like a Label, ListView element, Fader etc.: Start typing the command "VGet" and you will see the full list of possibilities.

If you like to lock a variable, use the command `VLock, Name`. The variable can not be changed until it is unlocked.

Fading a variable is possible with these commands `VFadeTo, Variable, Value, Time` and `VFade, Variable, StartValue, EndValue, Time`.

### How to use variables?

Once a variable is declared it can be used by its alias name. There are several ways to do so; one is, creating nodes.

The Variable Input Node can be found under Nodes > Input > Generic and can be linked to a filter or output node in order to use the variable's value there. The Variable Output Node can be found under Nodes > Output > Generic and can be linked to a filter or input node in order to use their value as the new variable value. In the depicted example the Fader Input Node writes the fader's value into a variable. Then the Variable Input Node writes the value into a label.



Some controls, e.g. a label allows accessing a variable directly. In the example we could delete the Variable Input Node (ID 1) and the Label Output Node (ID 3) and instead tick the check box "Variable Source" in the label's Item Properties.

The last way is using a variable in commands. There are several commands that allow writing a value into a variable, in the command list they start with [VGet...](#)<sup>1387</sup>. As well you may use commands to assign a specific value or result of a math operation to a variable.

To use a variable's value instead of an argument within a command simply use the variable name. For example, `TCPSend, 1, Text` will send "This is a string" via the TCP Connection not only "Text" as we have declared a variable with the name Text before. Widget Designer looks up any command argument whether it is a variable or not. If so, the variable value is used instead. For this reason it is not recommended to use numbers as variable names.

### What is the difference between a variable, a member value and a session value?

Member values are internal variables. See [here](#)<sup>1196</sup> more details and a list of member values.

#### 17.5.11.1 MEMBER AND SESSION VALUE LIST

##### What are member and session values?

Member and session values are internal control variables. The difference to [normal variables](#)<sup>1193</sup> is, that they are declared automatically within the program whereas normal variables must be first declared by the user. Secondly, a member value is always assigned to the same control or tool whereas a normal variable can hold the type the user has declared and the value the user has assigned. Then, member values are not displayed in the Variable List, there is no visualization. Lastly, the way, they are processed and updated utilizes less performance.

A member value refers always to the same control or general setup in the local Widget Designer (WD) application whereas the session value only exists if the feature [Web Server](#)<sup>1177</sup> is used as it refers to the web instances of these controls. One could imagine that a multi-session control can have more than one single value defining it. It rather has a value array, whereas the first tuple stands for the WD value (the member value itself) and all other tuples represent an optional session value.

##### How to use member values?

If two faders are created, the member values `fader1.value` and `fader2.value` are declared as an internal control variable with a double type (numbers with decimal places). Equally, as soon as one label is created, the member value `label1.text` is declared with a string type. If you are not familiar with the different variable types, please read the topic [Variables](#)<sup>1193</sup>.

Using the Web Server feature in the ULT edition gives controls the possibility to have multi-session values. As soon as a web browser from IP 10.169.10.25 calls the Web Server and displays a multi-session control, this control has the member values `fader1.value` and at the same time `fader1.sessionvalue.10.169.10.31`

Now, there is a major difference how normal variables and member values are processed. Normal variables can be used in three ways:

- in [nodes](#)<sup>959</sup>: if you link a Fader Input Node with a Variable Output node, this variable is updated 60

times per second (default entry for the [Node Cycle Interval](#)<sup>1252</sup>) and always holds the fader's value

- in [controls](#)<sup>879</sup>: if you tick the check box "Variable Source" in a [label](#)<sup>931</sup> control and assign a variable, the label is updated 60 times per second and always displays the variable's value
- in [commands](#)<sup>1254</sup>: if you use a variable as a command argument, the value is called as soon as the command is executed

Member values are designed to save performance. They are not constantly updated, thus cannot be used in input or output nodes or in controls. But it is a very good practice to use them in commands. For example:

- The command `TCPsend, 1, fader1.value` will send the current value of fader 1 via the TCP connection as soon as it is executed via a [Macro](#)<sup>1191</sup> or [Custom Script Button](#)<sup>884</sup>.
- The command `label1.text = fader1.value` will display the current value of fader 1 in the label each time, the command is executed. This command actually assigns a member value to another member value.

### How many member values are there?

Please see this table. As an example, the Custom Script Button has members that are defined as `customscriptID.membername`. The (main, local WD) member value is defined as `customscriptID.value`. It returns 0 or 1 depending on whether the according CS Button is in the click status or the release status.

The web session value is defined as `customscriptID.sessionvalue.sessionaddress`. The session address might be a number like 10.169.10.25 or a variable like "senderip"

The Custom Script Button can also be used to trigger an Action script, the trigger value is defined as `customscriptID.valuechanged`. When the CS Button is clicked, the script entered in the text field will be executed.

In return, some values can be directly assigned. For example `label1.text = hello` will assign "hello" to the first label. This is also possible with all variables. The second column of the below tables shows you whether a control can be directly assigned (\*1).

Control Name	* 1	Prefix for all Members	Member Value	Session Value	Action
<a href="#">Custom Script Button</a> <sup>884</sup>		customscriptID	~.value	~.sessionvalue	~.valuechanged
<a href="#">Script Timer</a> <sup>888</sup>		scripttimerID			~.started ~.stopped ~.tick
<a href="#">Image Loader</a> <sup>891</sup>		imageloaderID	~.value	~.sessionvalue	~.valuechanged
<a href="#">Video Snapshot</a> <sup>893</sup>		videosnapshotID	~.value	~.sessionvalue	~.valuechanged
<a href="#">Art-Net Snapshot</a> <sup>896</sup>		artnetsnapshotID	~.value	~.sessionvalue	~.valuechanged
<a href="#">Art-Net Recorder</a> <sup>898</sup>		artnetrecorderID	~.value	~.sessionvalue	~.valuechanged
<a href="#">Cue List</a> <sup>908</sup>		cuelistID			~.cuechanged
<a href="#">Drop Down List</a> <sup>918</sup>		dropdownID	~.text ~.index		~.selectedindexchanged
<a href="#">Encoder</a> <sup>922</sup>	x	encoderID	~.value		~.valuechanged
<a href="#">Fader V / H</a> <sup>925</sup>	x	faderID	~.value		~.valuechanged
<a href="#">Wheel V / H</a> <sup>928</sup>	x	wheelID	~.value		~.valuechanged
<a href="#">Label</a> <sup>931</sup>	x	labelID	~.text		~.textchanged

<a href="#">List</a> <sup>932</sup> <a href="#">View</a> <sub>932</sub>		listviewID	~cell.colID.ro wid		
<a href="#">Textbox</a> <sup>953</sup>	x	textboxID	~.text	~.sessionvalue	~.textchanged
Play List		playlistID			~.cuechanged
<b>Other properties</b>					
Time (in WD application)		time	~.year ~.month ~.day ~.dayofweek ~.dayofyear ~.hour ~.minute ~.second		
<a href="#">For Loops</a> <sup>1434</sup>		for	~.index		
Phidget RFID		phrfid			~.idchanged

### How to evaluate session values ?

Each session adds a value instance per control. There are different ways how to work with session values.

itemnameID.sessionvalue.sessionaddress sendername...	<p>If you know the user's IP address, you might use it directly, e.g.  <code>fader1.sessionvalue.10.169.10.25</code> to have his session value for the first value returned.          For example, if he likes to know what status a fader has, you could write into the Click Script of a Custom Script Button:  <pre>label1.text = fader1.sessionvalue.10.169.10.25</pre>         and the label displays "150.6" as soon as you click the button.          The internal system variable "sendername" is automatically declared when WD is loading. It represents the control's name from where exactly a command was sent, e.g if the Click script says <code>label1.text = sendername</code>, the label would display "CustomScript1".          You may combine the variable with a session value.</p>
...senderip	<p>If you do not know the user's IP address, you can use a variable instead. The internal system variable "senderip" is automatically declared when WD is loading and can hold more than one value - one more per each session. Thus the variable senderip adopts to the according IP address from where the command was sent. Now, the user himself can transfer a sessionvalue.          For example, if he should vote with a fader and then transfer the result with a Custom Script Button you could write into the Web(!) Click Script:  <pre>label1.text = fader1.sessionvalue.senderip</pre>         and the label displays "150.6" as soon as he clicks the button.</p>

itemnameID.sessionvalue.count	This value returns the total number of users that are connected to the Web Server, it returns the session count. For example, <code>fader1.sessionvalue.count</code> returns "2" if two users are connected, no matter whether they have used the fader yet or view the page where it is located.
itemnameID.sessionvalue.min itemnameID.sessionvalue.max	These values return the smallest / largest value of a control or other item. For example, if the two users have voted already and the first user gives a score of 1 and the second user one of 3, <code>fader1.sessionvalue.min</code> returns "1" whereas <code>fader1.sessionvalue.max</code> returns "3".
itemnameID.sessionvalue.sum	This value returns the total number of all session values. For the above example, <code>fader1.sessionvalue.sum</code> returns "4".
itemnameID.sessionvalue.avg	This value returns the average of all session values which is the result of the calculation: sum divided by count. For the above example, <code>fader1.sessionvalue.avg</code> returns "2".
itemnameID.sessionvalue.clear	This value actually works as a command as well, it deletes all session values for an item. It may happen that an internet connection is unstable and the connection to the Web Server is interrupted for a short time. The default behavior in WD is, that a session value is remembered and not rejected.

**17.5.11.2 MATH EXPRESSIONS**

In the last two chapters you have learned how to assign single (absolute) values to [Variables](#)<sup>1193</sup> and [Member Values](#)<sup>1196</sup>. This chapter shows, how to assign values in a more complex way. You may for example add a relative value to the current one, or execute a mathematical operation to calculate your new value.

Obviously, the variable must be of the type integer or double to allow mathematical operations. Integers are rounded to the according whole number. However there is one exception to this rule. Adding letters is actually possible and equals appending letters.

Array variables are supported too. You call an index with square brackets: `Variable[Index]`.

First, the below examples for a relative value assignment work in direct and in common commands. They offer the four basic arithmetical operations: addition, subtraction, multiplication and division. The value itself can be a number you choose, another Variable, or a Member Value.

direct command	Result varRes	corresponding common command
n.a.	123	VInt, VarName, Value VInt, varRes, 123
Variable += Value varRes += 3	126	VAdd, VarName, Var1, Var2 VAdd, varRes, varRes, 3
Variable -= Value varRes -= 1 (or: varRes += -1)	125	VSubtract, VarName, Var1, Var2 VSubtract, varRes, varRes, 1
Variable *= Value varRes *= 2	250	VMultiply, VarName, Var1, Var2 VMultiply, varRes, varRes, 2
Variable /= Value varRes /= 5	50	VDivide, VarName, Var1, Var2 VDivide, varRes, varRes, 5
n.a.	6.250.000	VPow, VarName, Var1, Var2 VPow, varRes, varRes, 4
n.a.	2500	VSqrt, VarName, Var1 VSqrt, varRes, varRes, 2
n.a.	he	VString, VarName, Value VString, varText, he
Variable += Value varRes += llo	hello	VAdd, VarName, Var1, Var2 VAdd, varText, varText, llo



For more complex operations, there are Math Expressions. There are only available for direct commands. Variables and member values can be accessed in the expression itself by typing them in quotation marks (inverted commas), see below. Remember to assign a suiting type to the variable for the result, e.g. "Double".

direct command	Result
<code>varRes = Math[calculation]</code>	
<code>varRes = Math[1+2]</code>	3
<code>varRes = Math[4-1]</code>	3
<code>varRes = Math[1*3]</code>	3
<code>varRes = Math[6/2]</code>	3
<code>varRes = Math[6/-2]</code>	-3
<code>varRes = Math[12%5] (modulo)</code>	2
Multiplication and division first, then addition and subtraction	
<code>varRes = Math[1+2*3]</code>	7
<code>varRes = Math[(1+2)*3]</code>	9
<code>varRes = Math[(1+2)*(5-1)]</code>	12
Accessing variables and member values with '	
<code>varRes = Math['var1'+1]</code>	depends
<code>varRes = Math['fader1.value'+1]</code>	depends
<code>varRes = Math[-'fader1.value'+1]</code>	depends
Logical expressions return 1 and 0 for true and false	
OR (  )	
<code>varRes = Math[1  0]</code>	1
<code>varRes = Math[1  1]</code>	1
<code>varRes = Math[0  0]</code>	0
AND (&&)	
<code>varRes = Math[1&amp;&amp;0]</code>	0
<code>varRes = Math[1&amp;&amp;1]</code>	1
<code>varRes = Math[0&amp;&amp;0]</code>	0
<code>varRes = Math[(1+0) &amp;&amp; (0-0)]</code>	0
<code>varRes = Math['var1' &amp;&amp; 'fader1.value']</code>	depends
Relational expressions return 1 and 0 for true and false	
Equals, Not equals,.... ( =, ==, !=, <> )	
=, ==, !=, <>	
Smaller, ... or equals, Greater, ... or equals ( <, <=, >, >= )	
<code>varRes = Math[3&lt;5]</code>	1
<code>varRes = Math[5&lt;3]</code>	0
<code>varRes = Math[3&lt;3]</code>	0
<code>varRes = Math[3&lt;=3]</code>	1
<code>varRes = Math['var1' &amp;&amp; 'fader1.value']</code>	depends

The following functions are supported in Math Expression as well. Remember to assign a suiting type to the variable for the result, e.g. "Double". In the interests of clarity, the result is rounded to two digits.

description and direct command	Result
Abs returns the absolute value of a specified number. <code>varRes = Math[Abs(-1.23)]</code>	1.23
Acos returns the angle whose cosine is the specified number (in radians!). <code>varRes = Math[Acos(0.99)]</code>	0.14
Asin returns the angle whose sine is the specified number (in radians!). <code>varRes = Math[Asin(0.99)]</code>	1.43
Atan returns the angle whose tangent is the specified number (in radians!). <code>varRes = Math[Atan(0.99)]</code>	0.78
Ceiling returns the smallest integer greater than or equal to the specified number. <code>varRes = Math[Ceiling(1.5)]</code>	2
Cos returns the cosine of the specified angle (in radians!). <code>varRes = Math[Cos(30)]</code>	0,15
Exp returns e raised to the specified power. <code>varRes = Math[Exp(1)]</code>	2.72
Floor returns the largest integer less than or equal to the specified number. <code>varRes = Math[Floor(1.5)]</code>	1
Log returns the logarithm of a specified number. <code>varRes = Math[Log(10, 5)]</code>	
Log10 returns the base 10 logarithm of a specified number. <code>varRes = Math[Log10(5)]</code>	0.7
Max returns the larger of two specified numbers. <code>varRes = Math[Max(1, 2)]</code>	2
Min returns the smaller of two numbers. <code>varRes = Math[Min(3, 4)]</code>	3
Pow returns a specified number raised to the specified power. <code>varRes = Math[Pow(5, 2)]</code>	25
Round rounds a value to the nearest integer or specified number of decimal places. <code>varRes = Math[Round(1.234, 2)]</code>	1.23
Sign returns a value indicating the sign of a number. <code>varRes = Math[Sign(-10)]</code>	-1
Sin returns the sine of the specified angle (in radians!). <code>varRes = Math[Sin(30)]</code>	-0.99
Sqrt returns the square root of a specified number. <code>varRes = Math[Sqrt(25)]</code>	5
Tan returns the tangent of the specified angle (in radians!). <code>varRes = Math[Tan(30)]</code>	-6.41
Truncate calculates the integral part of a number. <code>varRes = Math[Truncate(10.73)]</code>	10

Math Expression also accept conditions. For more information, visit <http://msdn.microsoft.com/en-us/library/ty67wk28.aspx>

direct command	Result True	Result False
Condition ? True : False varRes = Math[(2 > 1) ? 5 : 3] varRes = Math[('var1' < 'var2') ? 'var1' : 'var2'] varRes = Math[('var1' = 2) ? -10 : (1+2)*'var2'/2]	5 var1 -10	- var2 1,5*var2
Combined condition with above described AND varRes = Math[(1 < 2) && ('var1' = 2) ? 5 : 3]	5	3

### 17.5.12 KEYBOARD INPUT

Widget Designer supports multiple hardware Keyboard interfaces. You may setup any keyboard interface with scripts to define the custom button actions.

To setup any Keyboard input click on the desired button that you want to setup and enter the script into the text field. To store the script for the button press apply or close to apply and exit the editor.

See here the list of optional keypads:

The [Shortcut Editor](#)<sup>1204</sup> allows you to customize keyboard shortcuts for direct script control.

The [Jog Shuttle](#)<sup>1205</sup> unit that is also provided for Pandoras Box Manager Systems lets you setup a second page of controls by using the switch on the top right hand side of the controller.

Similar to the Jog Shuttle controller a [58 Keys](#)<sup>1206</sup> interface is available without the jog control but more control buttons instead. Two pages can be setup independently.

A Keyboard interface with [84 Keys](#)<sup>1206</sup> on 8 pages is also available to be customized for your needs.

A Keyboard interface with [128 Keys](#)<sup>1207</sup> on 8 pages is also available to be customized for your needs.

You may use the [Logitech Presenter R400](#)<sup>1208</sup> as well to execute scripts when pressing its buttons.

### 17.5.12.1 SHORTCUT EDITOR

Widget Designer supports customizable keyboard shortcuts for direct script control.

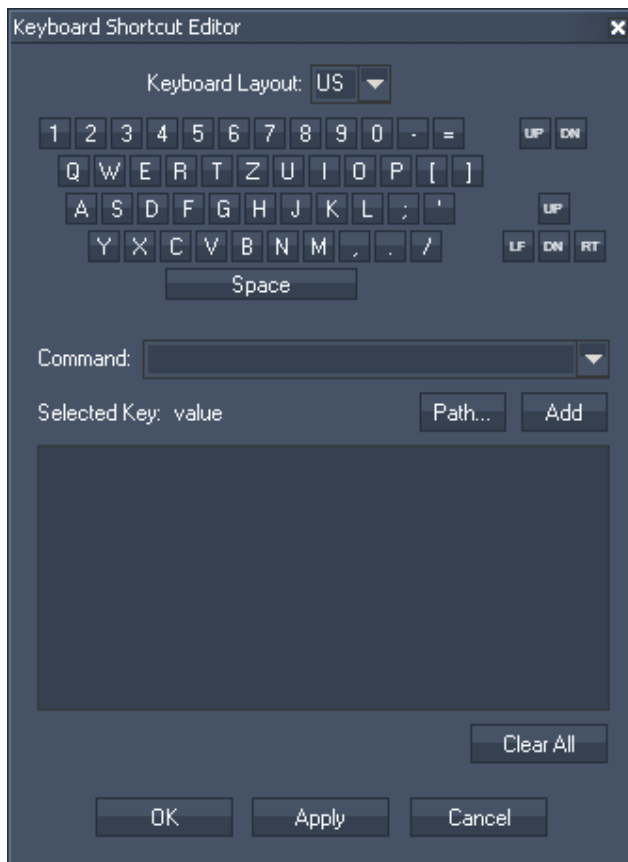

Please choose the Keyboard Layout (US or DE) from the list.

Now select the key that should be assign with a command either by clicking on it in the Keyboard Shortcut Editor or by pressing the key on your keyboard.

The key will be displayed above the text field, e.g.: Selected Key: W.

In the text box you may enter commands to be executed. You may use the drop-down list and the "Add" button or type directly in the text field. The topic [Script Language](#)<sup>1254</sup> explains this in more detail. See here a list of all [commands](#)<sup>1254</sup>. If you want to disable / enable the keyboard shortcuts you set up, please use [these commands](#)<sup>1343</sup>:

[Clear All] deletes all commands from the text field.

### 17.5.12.2 JOG SHUTTLE

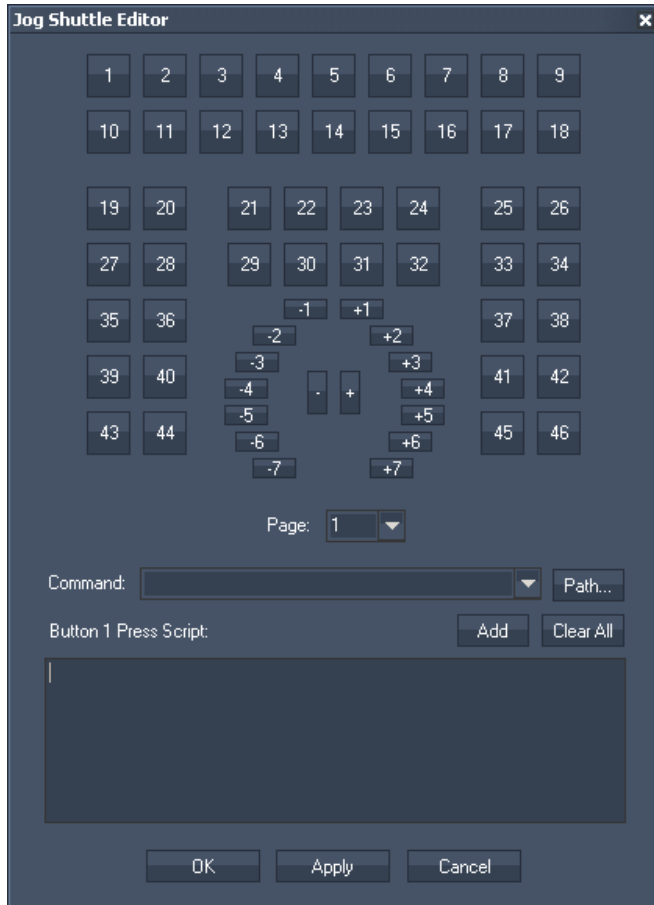

Please note:

All buttons on Page 1 will execute the additional script as well as the default command that is send to a Pandoras Box Master running on the WD computer. Page 2 does not send any commands by default to a Pandoras Box Master.

For example:

Button 1 on Page 1 lets the now pointer jump to Cue 1 by default and also executes a command you added.

### 17.5.12.3 58 KEYS

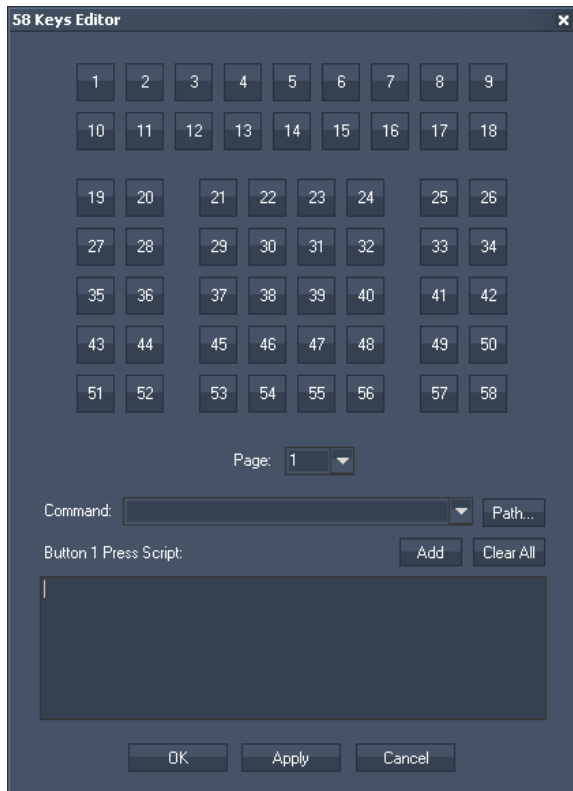

### 17.5.12.4 84 KEYS

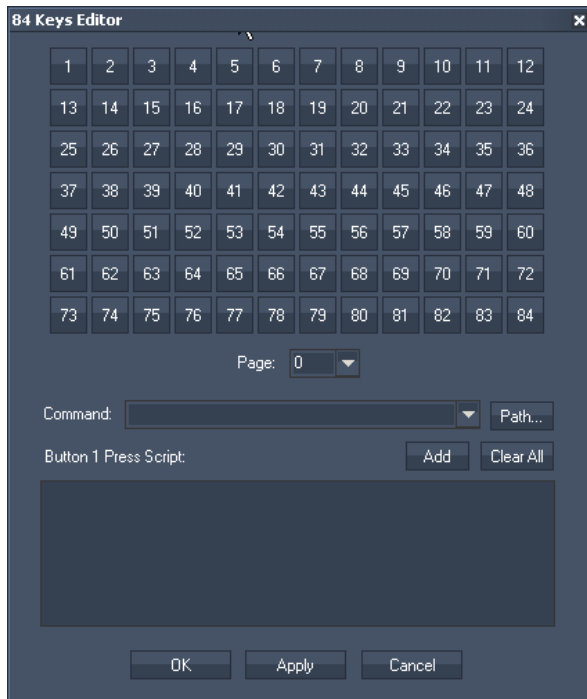

### 17.5.12.5 128 KEYS

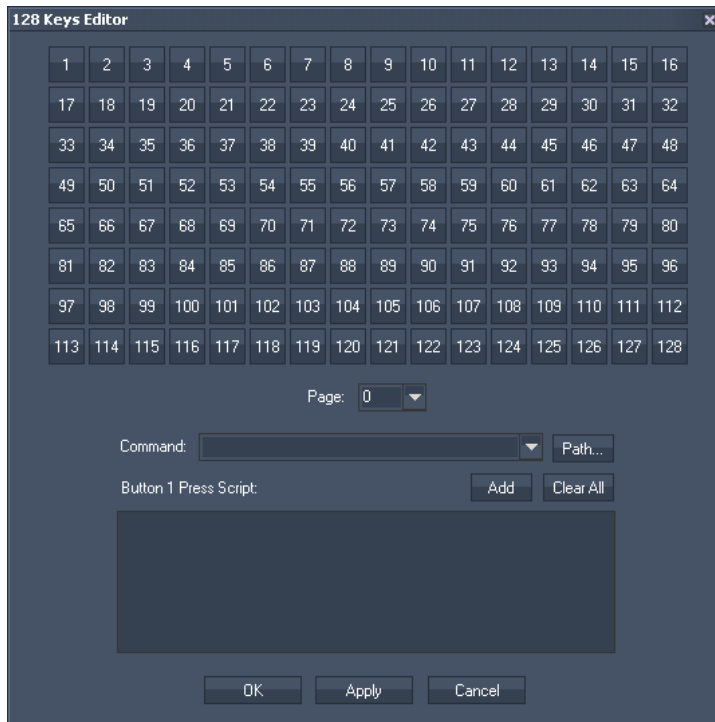

### 17.5.12.6 LOGITECH PRESENTER R400

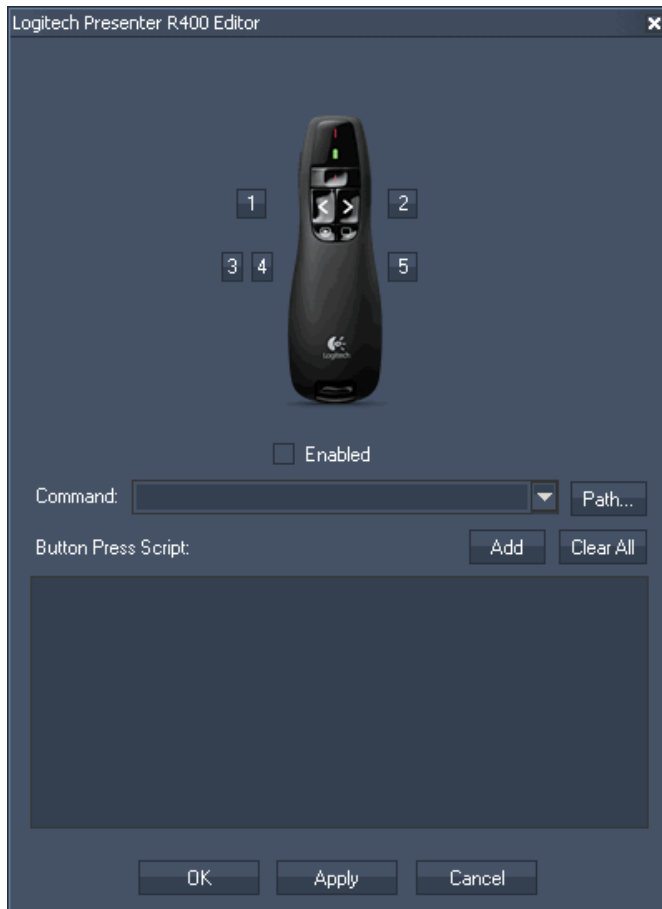

Enabled:

Check the small box to enable the Logitech Presenter.

To enable / disable the Logitech Presenter e.g. from a Custom Script Button, [these commands](#)<sup>1413</sup> are available.

### 17.5.13 MIDI INPUT

Choose between these Midi Inputs:

[Midi Notes](#)<sup>1209</sup>

You may choose to setup Midi Notes On/Off commands by using the Midi Note Editor.

[Midi Messages](#)<sup>1210</sup>

If you require intercepting any Midi Message you may use the Midi Message Editor.

#### MIDI DEVICE SUPPORT

If you wish to use an additional Midi Interface to control Widget Designer you may choose one of these supported midi devices to map its buttons and fader to scripts, parameters and value ranges.

[AKAI APC40](#)<sup>1211</sup>

[BCD 2000](#)<sup>1212</sup>

[BCF 2000](#)<sup>1213</sup>



### 17.5.13.1 MIDI NOTES EDITOR

Widget Designer supports standard Windows Midi Devices.

You may choose to setup Midi Notes On/Off commands by using the Midi Note Editor.

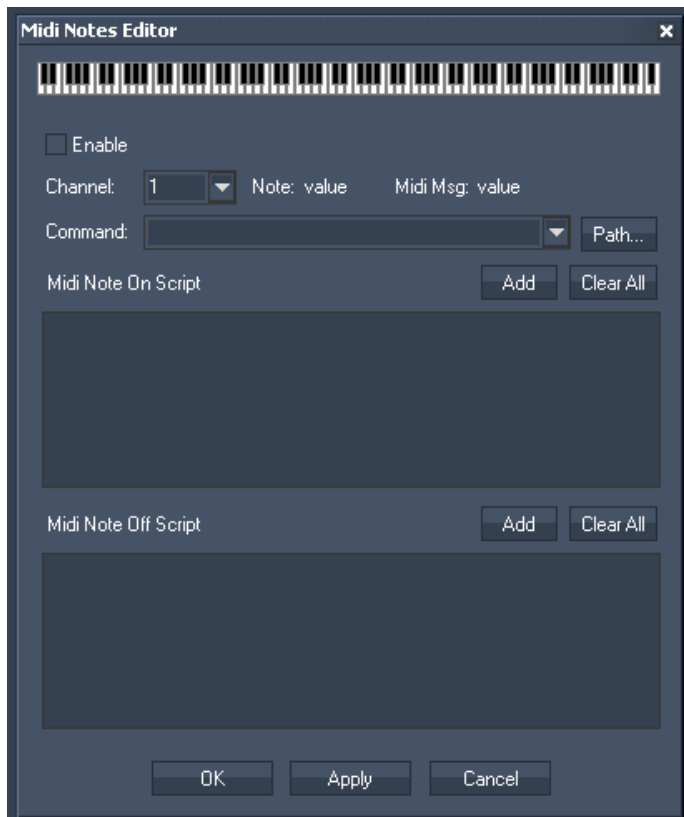

In order to receive any Midi Note Message please first setup the Midi Input device in the [Connection Manager](#)<sup>1166</sup>.

Tick the check box [Enable] to activate the Midi Notes Editor and remove the check if you want to disable incoming Midi Notes again.

Once this is up and running you will be able to see the incoming Midi Note messages in the Midi Note editor.

#### Scripts

In the Script section you may enter commands to be executed as Midi Note On and/or Midi Note Off script. You may use the drop-down list and the "Add" button or type directly in the text field. The topic [Script Language](#)<sup>1254</sup> explains this in more detail.

See here a list of all [commands](#)<sup>1260</sup>.

To delete a script text box entirely, click [Clear All] above each script.

If you would like to setup the Midi Note On/Off scripts offline, just click on the graphical piano to choose the desired note and enter the desired Note On and/or Note Off script.

Press Apply to store the script for this note.

### 17.5.13.2 MIDI MESSAGE EDITOR

If you require intercepting any Midi Message you may use the Midi Message Editor.

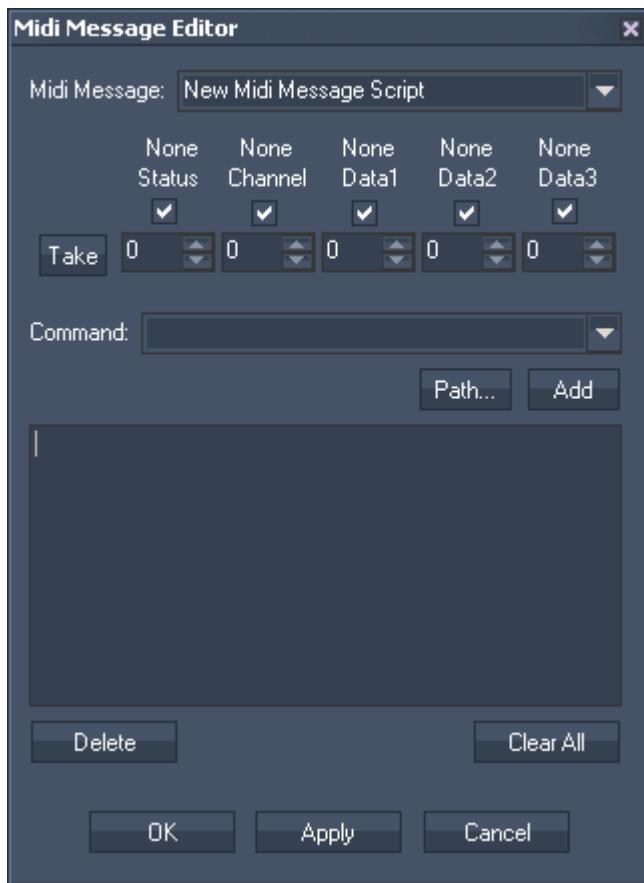

In order to receive any Midi Note Message, please first setup the Midi Input device in the [Connection Manager](#)<sup>1166</sup>.

With the Midi Message Editor you can filter out specific Midi Data and store commands like a Macro into a List of Midi Message Scripts. This list you can store for your Widget Designers project.

Use the check boxes to define if you wish the script to ignore or filter the related Midi Data.

Use the [Take] button to grab the incoming Midi Data values and store them with the [script](#)<sup>1254</sup> as Midi Message Script.

To Store a new Midi Message Script enter a new Name in the top drop-down list and press [Apply] or [OK].

If you wish to delete an existing Midi Message Script, pick the Midi Message Script to delete from the top drop-down list and press the Delete button.

### 17.5.13.3 AKAI APC40

If you wish to use an additional Midi Interface to control Widget Designer you may choose a AKAI APC40 to map its buttons and fader to [commands](#)<sup>1254</sup>, parameters and value ranges.



The AKAI APC40 allows using a separate Midi input device which is set up in the top section of the AKAI APC40 Editor:

To enable the Midi Input for the AKAI APC 40 board please choose your Midi Receive Device from the list and press [Apply].

Tick the check box [Enable] to enable the AKAI APC 40 board and remove the check if you want to disable the device again.

Once connected to the AKAI APC40 you may press a button or move a control to let Widget Designer intercept and give you access to the Controls scripts or Fader Encoder Settings.

To change any setting press on the control, enter your values and press [Apply].

### 17.5.13.4 BEHRINGER BCD 2000

If you wish to use an additional Midi Interface to control Widget Designer you may choose a Behringer BCD 2000 to map its buttons and fader to [commands](#)<sup>1254</sup>, parameters and value ranges.



The BCD 2000 allows using a separate Midi input device which is set up in the top section of the BCD 2000 Editor:

To enable the Midi Input for BCD 2000 board please choose your Midi Receive Device from the list and press [Apply].

Tick the check box [Enable] to enable the BCD 2000 board and remove the check if you want to disable the device again.

Once connected to the BCD 2000 you may press a button or move a control to let Widget Designer intercept and give you access to the Controls scripts or Fader Encoder Settings.

To change any setting press on the control, enter your values and press Apply.

### 17.5.13.5 BEHRINGER BCF 2000

If you wish to use an additional Midi Interface to control Widget Designer you may choose a Behringer BCF 2000 to map its buttons and fader to [commands](#)<sup>1254</sup>, parameters and value ranges.

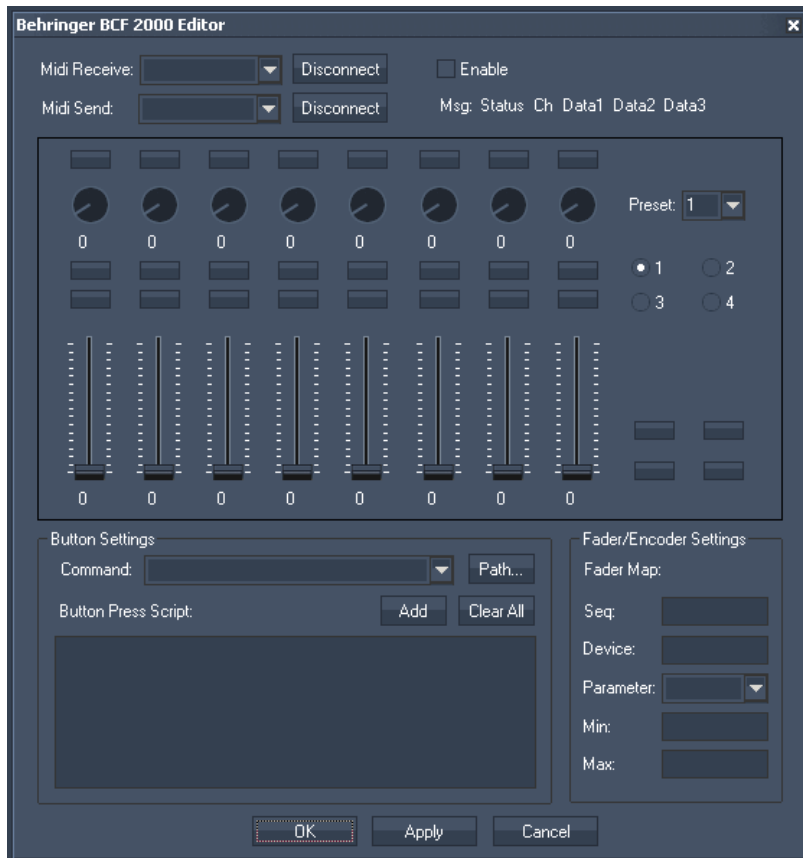

The BCF 2000 allows using a separate Midi input device which is setup in the top section of the BCF 2000 Editor.

Since the BCF 2000 is a freely programmable Midi Interface you will need to use the Learn function of the BCF 2000 to store the Midi value from WD into the unit.

To do this first set up the Midi Send Device in Order to receive the values in the BCF2000:

To enable the Midi Input for the BCF 2000 board please choose your Midi Send Device from the list and press [Apply].

Tick the check box [Enable] to enable the BCF 2000 board and remove the check if you want to disable the device again.

To store the faders, encoders and buttons you will need to select the desired page in both the BCF 200 Editor and on the BCF 2000 Control itself.

Once this is done, hold the learn button on the BCF and press or move any control item to go to the learn mode. Now click or click and drag any fader in the BCF 2000 Editor with the mouse until the BCF 2000 LCD Menu reads "Good".

To store commands or a value range for the individual control, click on the controls and enter your values and confirm with [Apply] or [OK] to store the value in Widget Designer.

### 17.5.14 BLACKLIST

Use the blacklist for filtering incoming [Emails](#)<sup>1214</sup>, [SMS](#)<sup>1219</sup> and [RSS feeds](#)<sup>1217</sup> for specific words.

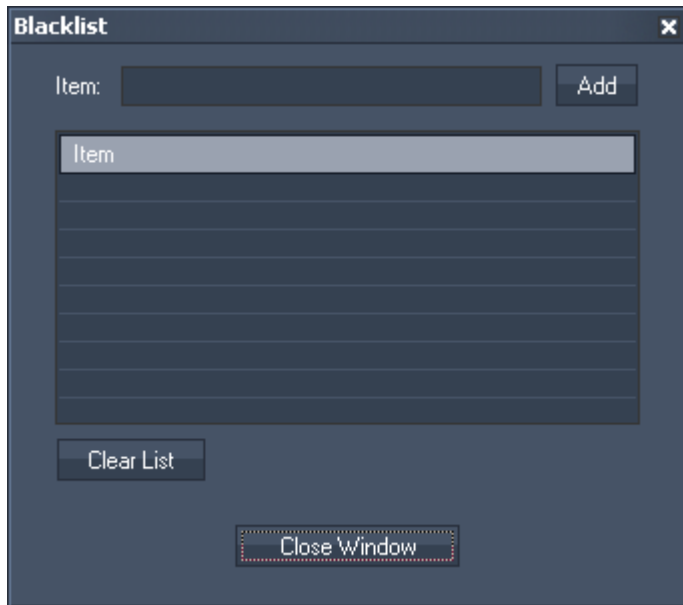

Enter the keywords one after another in the Item text field. Apply each keyword by pressing [Add]

To clear a single keyword from the list, right-click on this entry and choose "Delete".  
To clear the whole list, use the button [Clear List].

### 17.5.15 EMAIL SETTINGS

The Email Settings is the tool to setup all incoming and outgoing Email communication. To process the incoming emails inside Widget Designer, also use the Email commands "EmailSend,'To','Subject','Message'" and "EmailSendAtt,'To','Att','Subject','Message'", see [script language](#)<sup>1254</sup>.  
[Email Input Node](#)<sup>1000</sup>.

To process any data inside Widget Designer to send via Email, also use the dedicated .

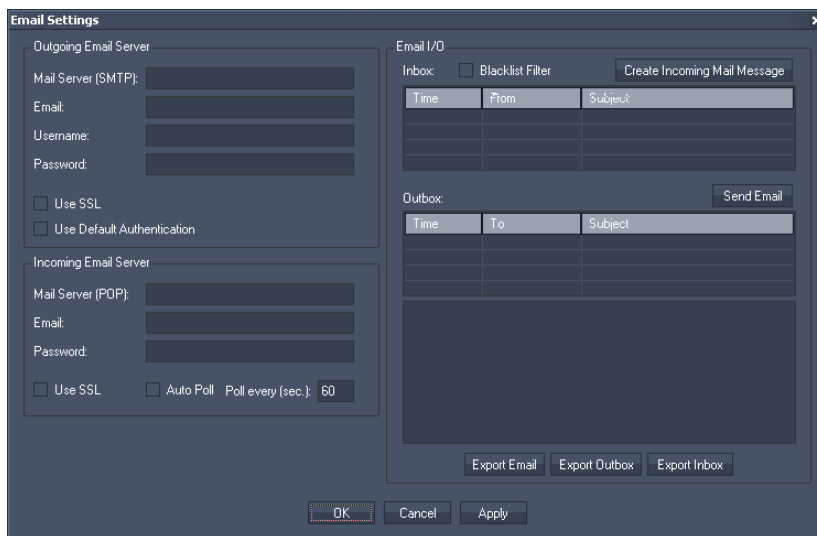

### Outgoing Email Server

Please enter all relevant information for your SMTP Mail Server settings, such as

- Mail Server (SMTP),
- Email Address,
- Username,
- Password.

Tick the check box "Use SSL" to use SSL (Secure Socket Layer).

Tick the check box "Use Default Authentication" to use default authentication.

### Incoming Email Server

Please enter all relevant information for your POP Mail Server settings, such as

- Mail Server (POP),
- Email Address,
- Password.

Tick the check box "Use SSL" to use SSL (Secure Socket Layer).

Tick the check box "Auto Poll" to automatically poll your email account. Enter the interval time in the text field aside.

If Auto Poll is not checked, your Email account will only be polled once when pressing Apply.

### Email I/O

Inbox:

To use the [Blacklist](#)<sup>1214</sup> filter, please check this option.

Click on "Create Incoming Mail Message" to get an email message without polling it from the mail server.

The following pop-up window opens:

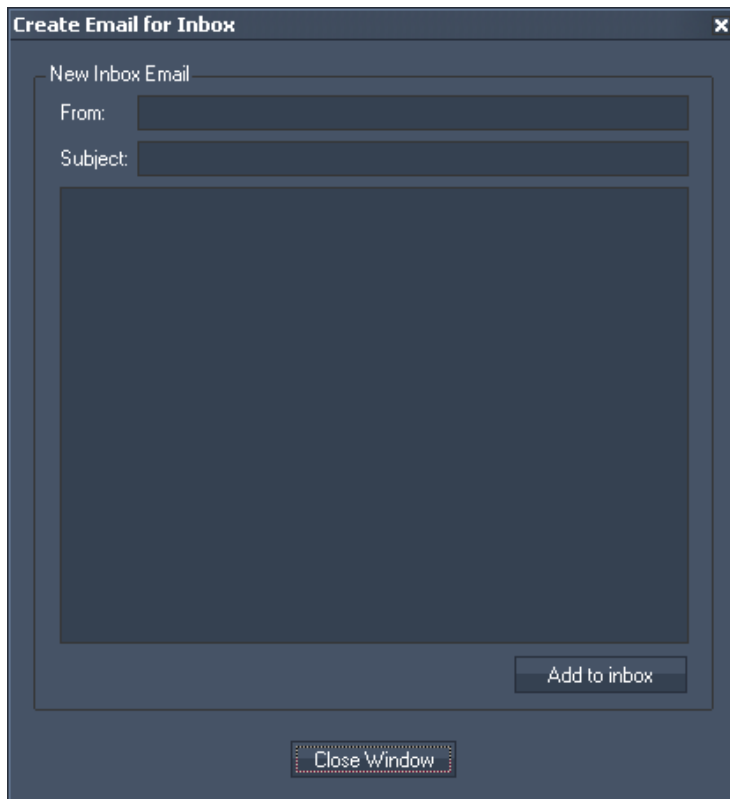

Click "Add to inbox" to receive this email in your inbox, click on Close Window if you do not want to send the email.

If you right-click on an email in your inbox, you have the opportunities to:

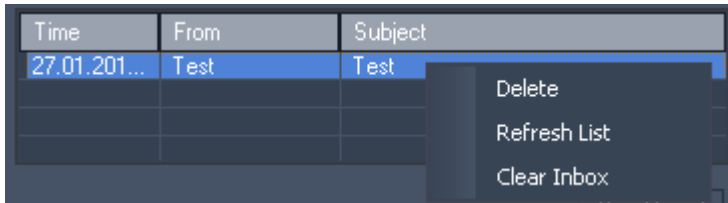

- Delete this mail,
- Refresh the Inbox List,
- Clear the Inbox.

Outbox:

In the Outbox all emails sent will be listed.

Click on "Send Email" to create an email directly in the outbox.  
The following pop-up window opens:

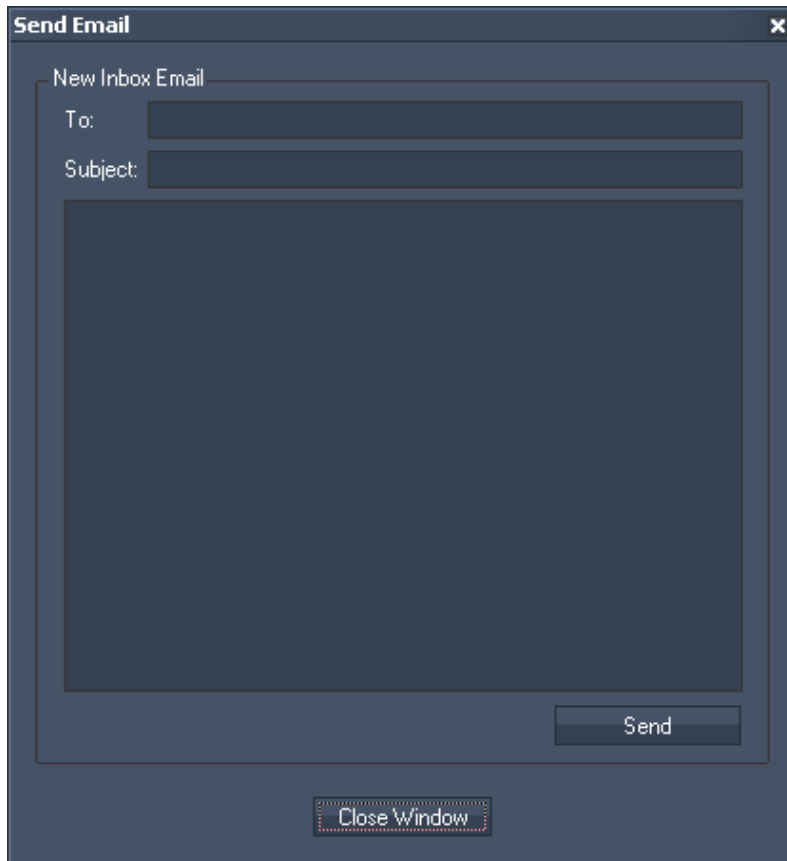

Enter the receiver, subject and message and press "Send" to send this email or directly "Close Window" to leave this dialogue.

If you right-click on an email in your outbox, you have the opportunities to:



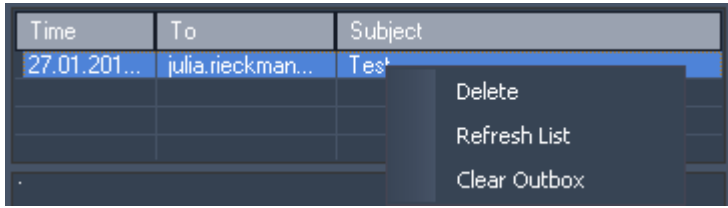

- Delete this mail,
- Refresh the Outbox List,
- Clear the Outbox.

**Export Email:**  
Exports all emails addresses listed in the inbox into a text file.

**Export Outbox:**  
Exports all emails listed in the outbox into a text file.

**Export Inbox:**  
Exports all emails listed in the inbox into a text file.

**17.5.16 RSS SETTINGS**

The RSS Settings is the tool to setup and create all RSS feeds. To process the incoming RSS feed inside Widget Designer, also use the [RSS Input Node](#)<sup>1050</sup>.

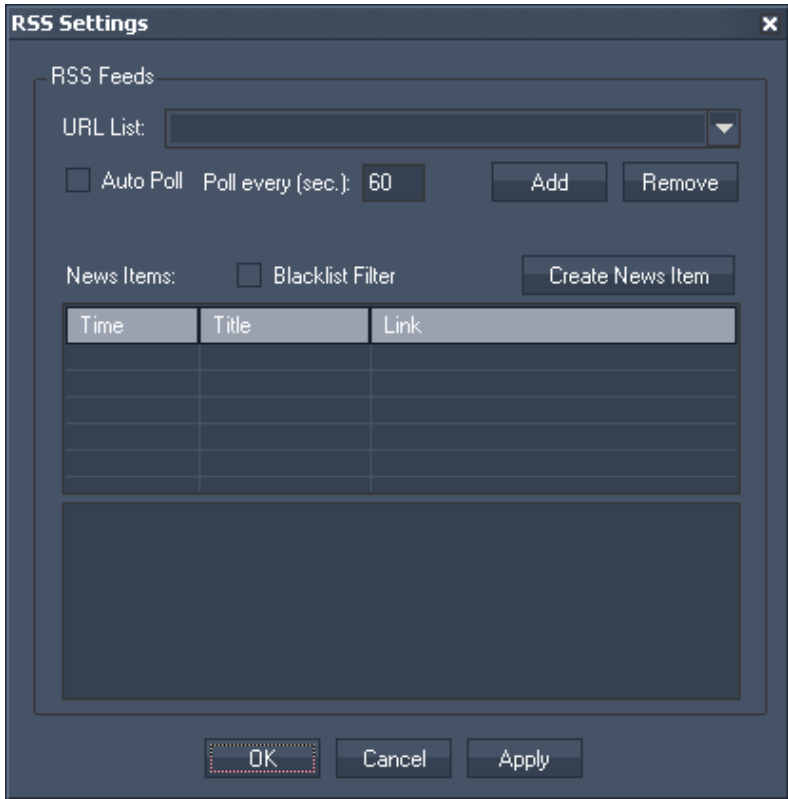

**URL List:**  
Enter a new URL manually in the text field or choose one from the list. To add an URL to the list, press [Add] after you entered it into the text field. Click [Remove] to remove this entry from the list.

Check "Auto Poll" and enter the Poll interval in seconds to automatically poll the RSS Feed. If this option is unchecked the RSS Feed will only be polled once when pressing [Apply] or [OK].

To use a prepared [Blacklist](#)<sup>1214</sup> for filtering the RSS Feeds for specific words, please check the option Blacklist Filter.

All received RSS Feeds will be displayed in the incoming RSS list.

Create new Items:

Click on this button create a RSS feed manually.

In the upcoming dialog enter the link that should be displayed, a title and the RSS message text.

Press [Add to RSS List] to transfer it to the incoming RSS list.

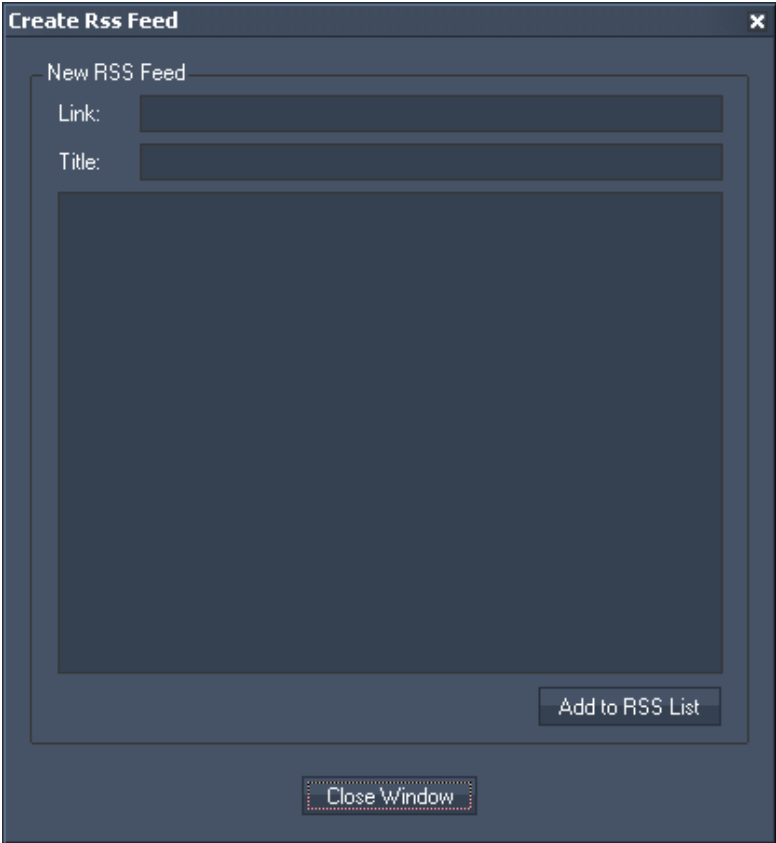

### 17.5.17 SMS SETTINGS

Setup your GSM modem in this tool to be able to receive and send SMS via the Widget Designer.

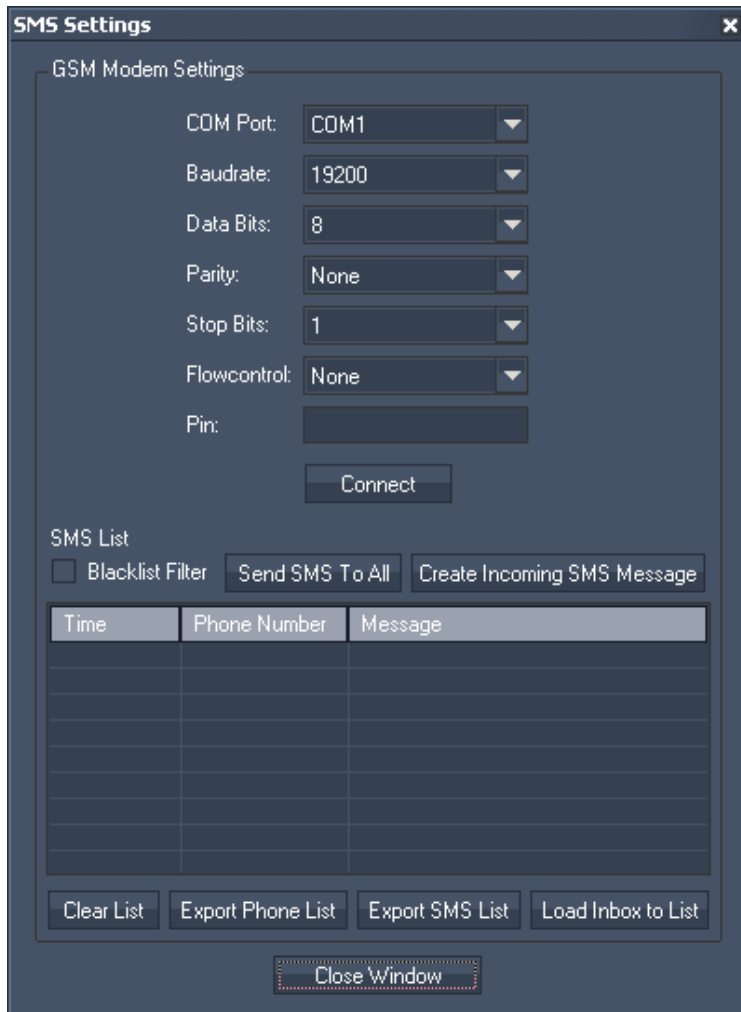

#### GSM Modem Settings:

Choose the COM Port, Baud rate, Data Bits, Parity, Stop Bits and the Flow control. Enter the Pin for the GSM Modem and press [Connect].

#### Blacklist Filter

To use a prepared [Blacklist](#)<sup>1214</sup> for filtering the incoming SMS for specific words, please check the option Blacklist Filter.

#### Send SMS To All:

Click on this Button to send a SMS message to all Phone numbers in the SMS List. The following pop-up window opens:

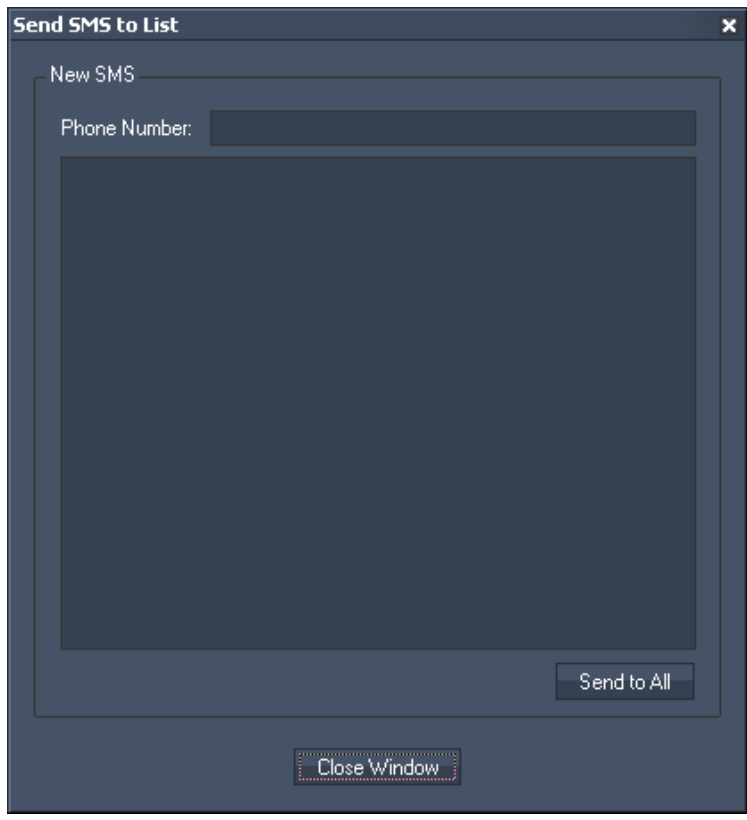

Additionally to all Phone numbers in the SMS list, the new SMS can be sent to any number entered in the text field next to Phone Number.  
Enter the SMS text in the text box.

Create Incoming SMS Message:  
Click on "Create Incoming SMS Message" to create a SMS message without polling it via the GSM Modem.  
The following pop-up window opens:

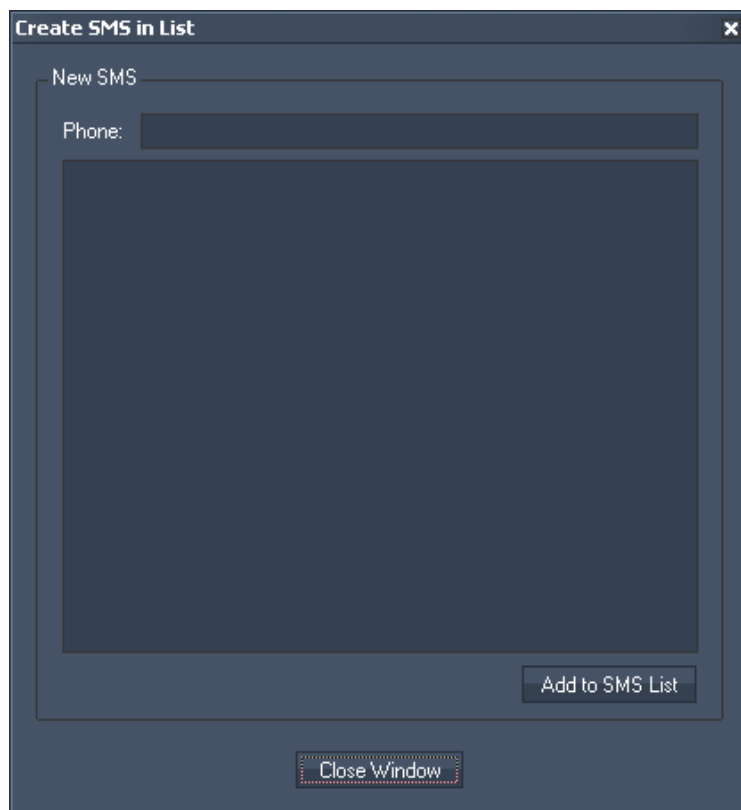

Enter the phone number that should appear as faked SMS sender in the text field.

Use the text box to enter the SMS text.

Push [Add to SMS List] to add this entry to the SMS Inbox list.

If you want to discard this entry, just press [Close Window] without adding it.

**Clear List:**

Click this button to clear the SMS List.

**Export Phone List:**

Click this button to export all SMS sender's phone numbers to a text file.

**Export SMS List:**

Click this button to export all SMS (phone number and message text) to a text file.

**Load Inbox to List:**

Load all SMS from your SIM Card into the Inbox.

## 17.5.18 FACE TRACKER

The Face Tracker Tool tracks a detected face and outputs its position data via the Face Tracking Input Node for further processing.

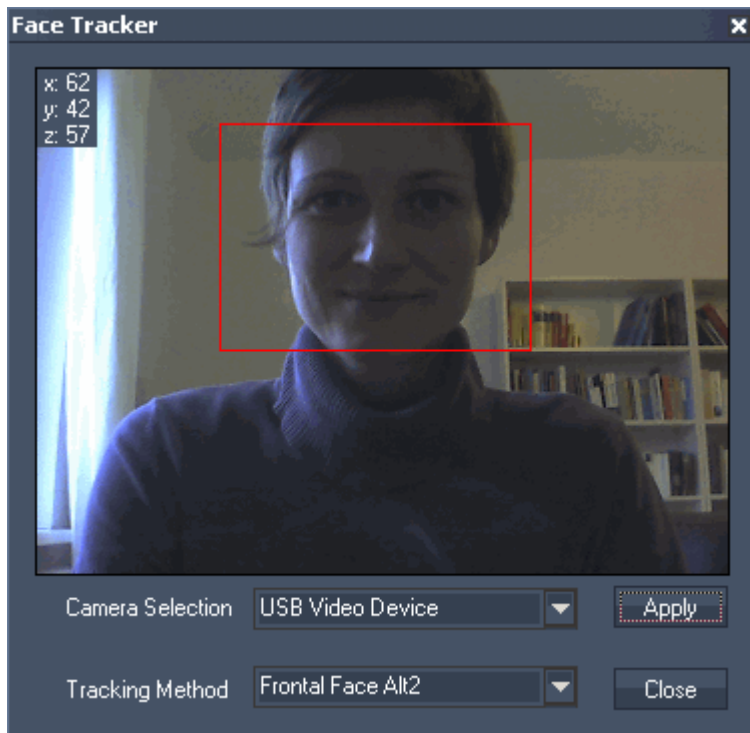

Choose your DirectShow Camera Device from the drop-down list and press [Apply.]

Choose the Tracking Method from the 2nd drop-down list. The following modes are available:

- Frontal Face Alt
- Frontal Face Alt\_Tree
- Frontal Face Alt2 (default)
- Full Body
- Lower Body
- Upper Body

As soon as the Face Tracker detects a face / body, it will be surrounded by a red rectangle. The position data of this rectangle (x,y,z) is displayed top left of the Window.

To use this data for further processing, please refer to [Facetracking Input Node](#)<sup>1003</sup>.

### 17.5.19 MOTION DETECTOR

The Motion Detector Tool lets you divide a video input into any amount of columns and rows. It displays the colour difference per segment caused by moving objects and outputs this data via the [Motion Detector Input Node](#)<sup>1037</sup> for further processing.

Please note:

This tool as well as the other video processing tools inside WD needs a lot of RAM and CPU power!

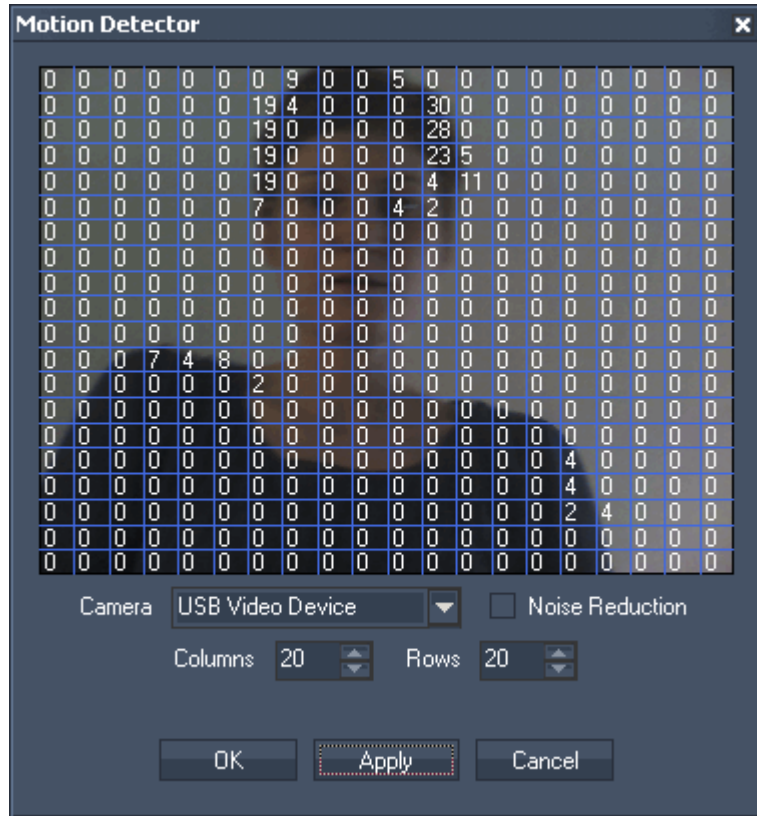

Camera:  
Choose your DirectShow Camera Device from the drop-down list.

Noise Reduction:  
Check this option to apply a noise reduction on the video input.

Columns:  
Enter here the amount of columns the video input should be divided in.

Rows:  
Enter here the amount of rows the video input should be divided in.

The values inside the single segments display the colour difference caused by moving objects.

To use these values for further processing, please refer to [Motion Detector Input Node](#)<sup>1037</sup>.

### 17.5.20 CAMERA POINT TRACKER

The camera point tracker lets you track up to 99 objects and outputs via an attached DirectShow compatible camera.

The tracking data is available via the Camera Point Tracking Input Node for further processing. The touch points may be used in e.g. the Multitouch Panel as well.

Please note:

This tool as well as the other video processing tools inside WD needs a lot of RAM and CPU power!

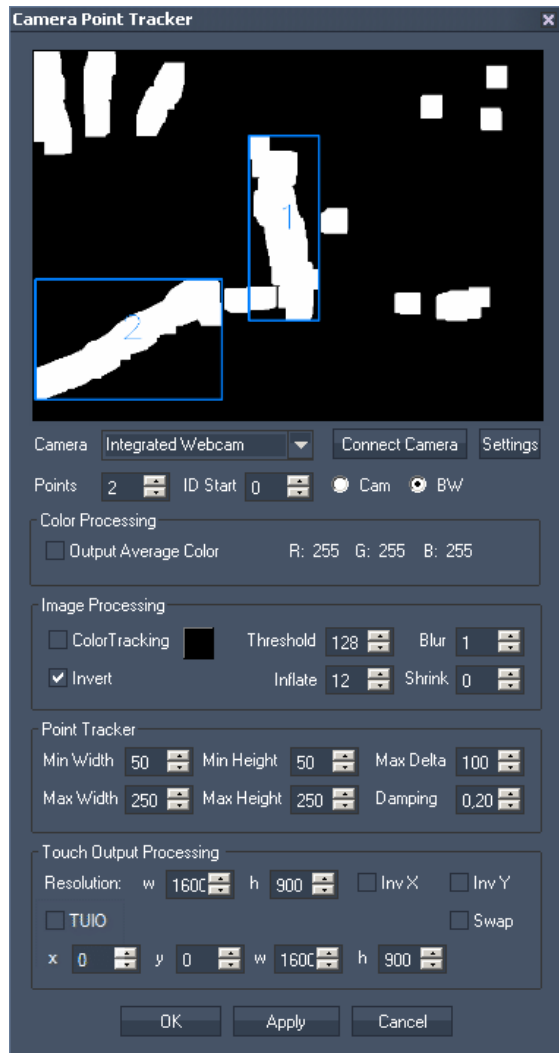

The tool window is divided into several sections:

- [Camera settings](#)<sup>1225</sup>,
- [Color Processing](#)<sup>1226</sup>,
- [Image Processing](#)<sup>1226</sup>,
- [Point Tracker](#)<sup>1226</sup> and
- [Touch Output Processing](#)<sup>1229</sup>.



### 17.5.20.1 CAMERA SETTINGS



**Camera:**

Choose your Direct Show Device from the list. Apply it by pressing [Connect Camera].

**Settings:**

Pressing this button the settings window will appear, where you may set up brightness, contrast etc. for your camera. This dialog depends of your camera's driver.

**Points:**

If you want to track more than 2 points (default setting) you may increase this value here to be able to track up to 99 points.

**ID Start:**

The generated touch points may get an ID offset that you can set up here. This offset can be helpful for the source identification if you have several touch inputs in a multi-touch panel coming from different touch point sources within the Widget Designer or from several Widget Designer instances.

**Cam / BW:**

When "Cam" is chosen the camera image will be displayed in the camera window above. This mode is helpful to set up the camera as well to choose a tracking color, see section [Image Processing](#)<sup>1226</sup>.

When "BW" is chosen the [Image Processing](#)<sup>1226</sup> and [Point Tracker](#)<sup>1228</sup> settings will be applied to the camera input, the result is shown in black and white.

**Example:**

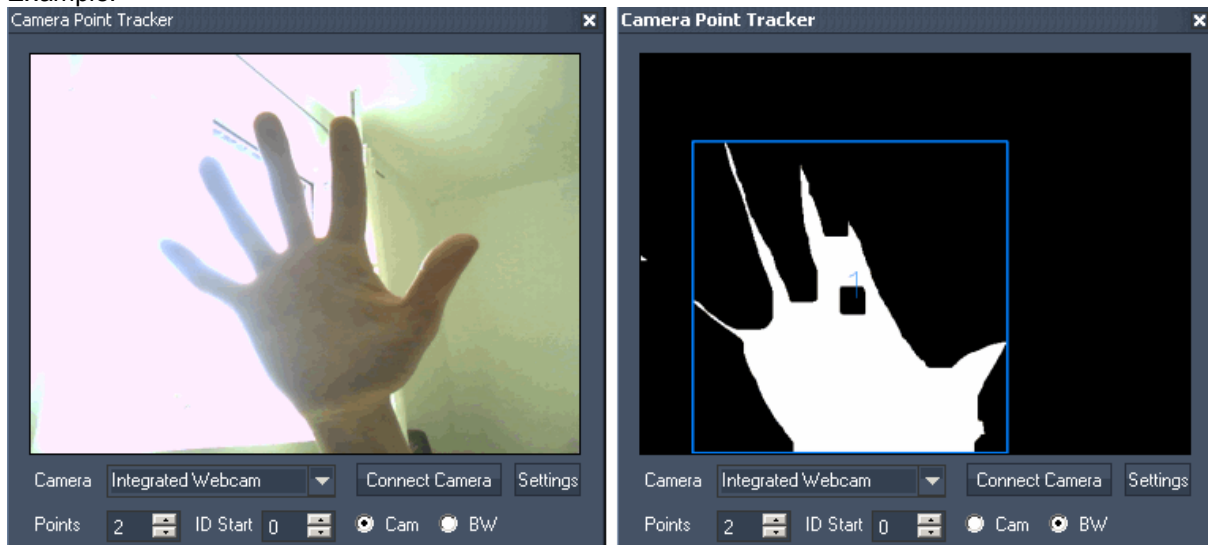

See here 2 scenes. Left image: in „Cam“ view, right image: in „BW“ view.

### 17.5.20.2 COLOR PROCESSING

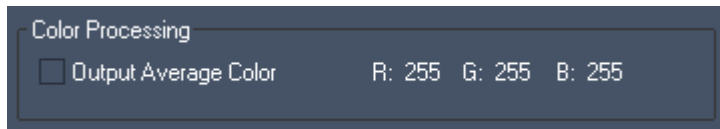

Output Average Color:

When this option is checked the [Camera Tracker Input Node](#)<sup>992</sup> will additionally output the average color of the camera input, separated in the colors red, green and blue.

### 17.5.20.3 IMAGE PROCESSING

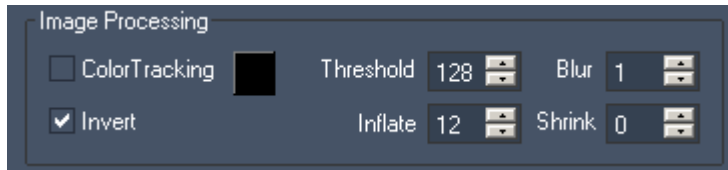

The image processing section allows adjusting the camera BW image to get the best point detection, depending on your lighting conditions and your setup. Therefore there are no recommended settings; you will always have to modify different parameters to get the best result.

Please note:

The point detection will take effect for the white parts of the black & white image, not for the black parts.

Color Tracking:

The tracking can be done with two different methods:

1. Based on all colors in the camera image,
2. Based on a color you picked.

The default setting is based on all colors in the camera image. If you want to use the Color Tracking, please tick the check box [ColorTracking].

To set a color that should be tracked, activate the “CAM”-Mode in the camera settings section so that you see the colored camera image above.

Picking a color directly from the camera image:

Proceed a mouse-click on the desired color in the camera image. The box next to the ColorTracking check box will overtake this color.

Picking a color from the color picker box:

Click on the colored box next to the ColorTracking check box. Now you may choose a color from the list.

Invert:

The inverted mode is enabled by default. In BW-Mode all lighter parts of the camera image will be shown in black, the darker parts will be shown in white, depending on the Threshold value. To disable the color inversion please remove the check.

As already mentioned above: The point detection will take effect for the white parts of the black & white image, not for the black parts.

Threshold:

Set up here the value for the threshold. The threshold defines which parts of the camera image will be converted into white and which ones into black parts when turning on the BW-Mode. It is related to the camera images luminance value by default. When Color Tracking is enabled, it is related to the special color chosen.

Example:

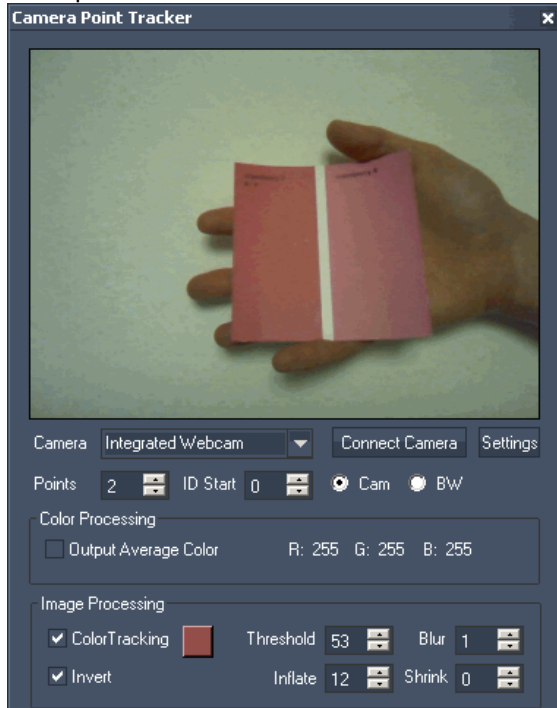

In the setup above the Color Tracking is enabled. The color was picked from the darker pink plane inside the camera image. The two pictures below show the tracking result depending on the threshold value.

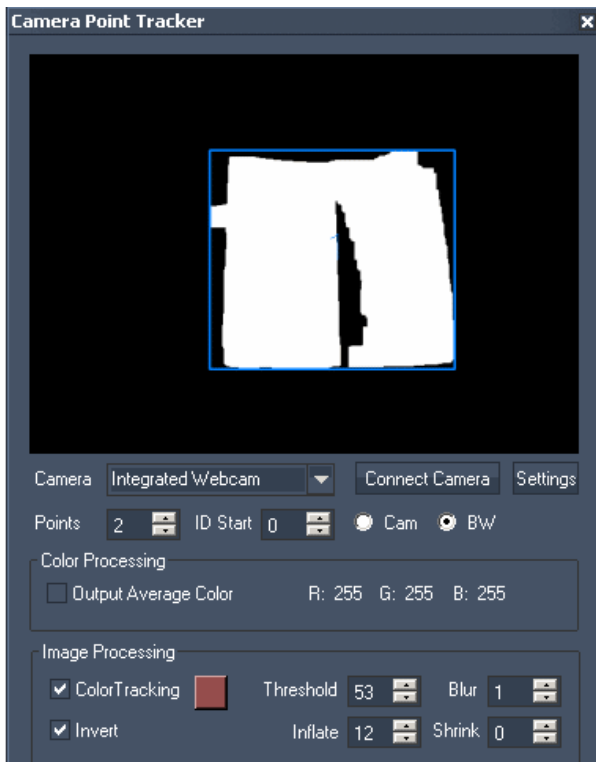
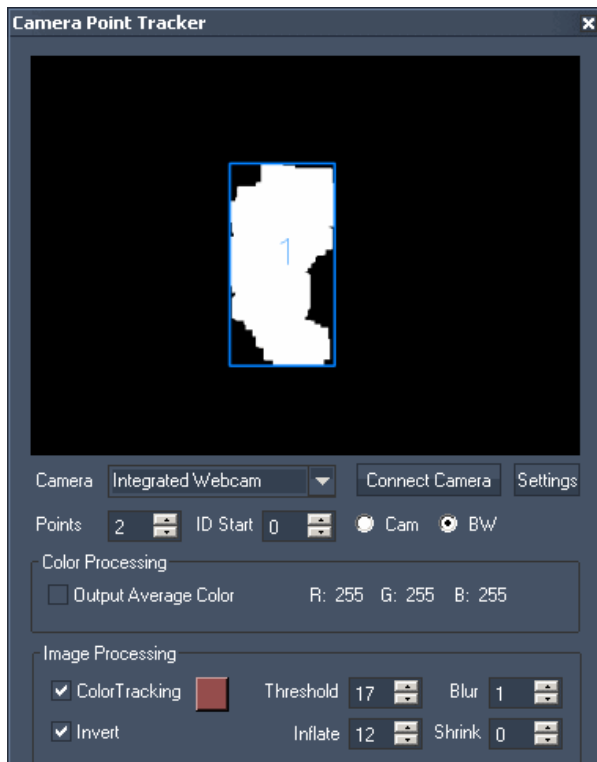

Left image: The threshold value is very small (17), only the darker pink plane is tracked.

Right image: The threshold value is increased to 53. The lighter pink plane is now tracked as well.

**Blur:**

Use this option to smooth the detected areas, so that rough pixels become smooth spots (0 = minimum blur, 15 = maximum blur).

Please be aware that increasing the blur value takes more performance!

**Inflate:**

This option inflates the detected areas (0 = minimum inflation, 15 = maximum inflation).

**Shrink:**

The result of the (eventually blurred and inflated) areas will be shrunk when using this option (0 = minimum shrinking, 15 = maximum shrinking).

**Please note:**

There are no recommendations which values would be best to enter for Blur, Inflate and Shrink. It depends on your setup and especially the lighting conditions.

**17.5.20.4 POINT TRACKER**

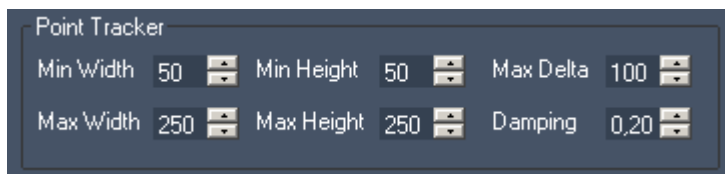

**Min Width / Max Width:**

Define which minimum and maximum width (in pixels) a spot should have to be detected as point. The pixel sizes are related to the camera's resolution.

**Min Height / Max Height:**

Define which minimum and maximum height (in pixels) a spot should have to be detected as point. The pixel sizes are related to the camera's resolution.

**Max Delta:**

The Max Delta value defines how far a point is allowed to move (in px, related to the camera's resolution) between two image frames in order to still be detected as point.

**Damping:**

The damping allows reducing noisy input values. The damping factor is set by default to 0,3. This setting can be changed from 0,1 = maximum damping up to 1 = no damping.

### 17.5.20.5 TOUCH OUTPUT PROCESSING

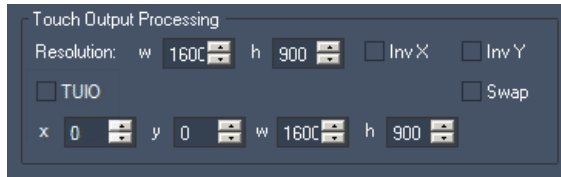

**Resolution (w/h):**

Please enter here the resolution of your monitor (w=width, h=height) where the WD runs on. This is needed to adopt the positions of the detected touch points to fit to your screen.

**Inv X:**

Check "Inv X" if you need to invert the X axis.

**Inv Y:**

Check "Inv Y" if you need to invert the Y axis.

**Swap:**

Check "Swap" if you need to swap the X and Y axis, e.g. when the camera is turned about 90°.

**TUIO:**

In order to output multi touch data to other applications this option allows to send the Camera Point Tracker's multi touch data via the open source protocol TUIO.

This protocol is widely used around the world by many application developers and is a commonly known way to transmit the individual touches.

To use Camera Point Tracker with TUIO, set up the TUIO host IP and Port in the [Connection Manager](#)

1166

**x/y/w/h (Range Conversion for Touch points):**

The range conversion for touch points can be used if the camera point tracker should only affect a specific screen region, or if multiple Widgets are used with multiple camera point trackers together.

Enter the position of the region's starting pixel (left top pixel) inside the text fields for x and y.

The regions size will be defined by entering its width (w) and height (h).

**Example:**

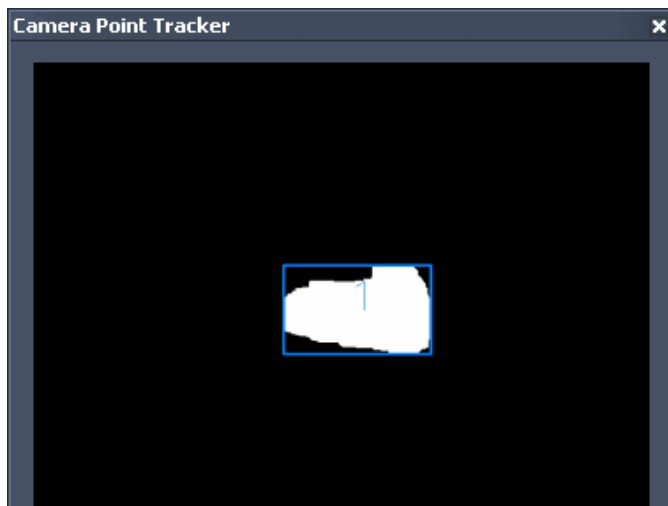

In the image above a point is tracked (point 1) in the center of the camera point tracking tool.

In the images below you see the usage of this touch point in a Multitouch Panel with different range conversion setups.

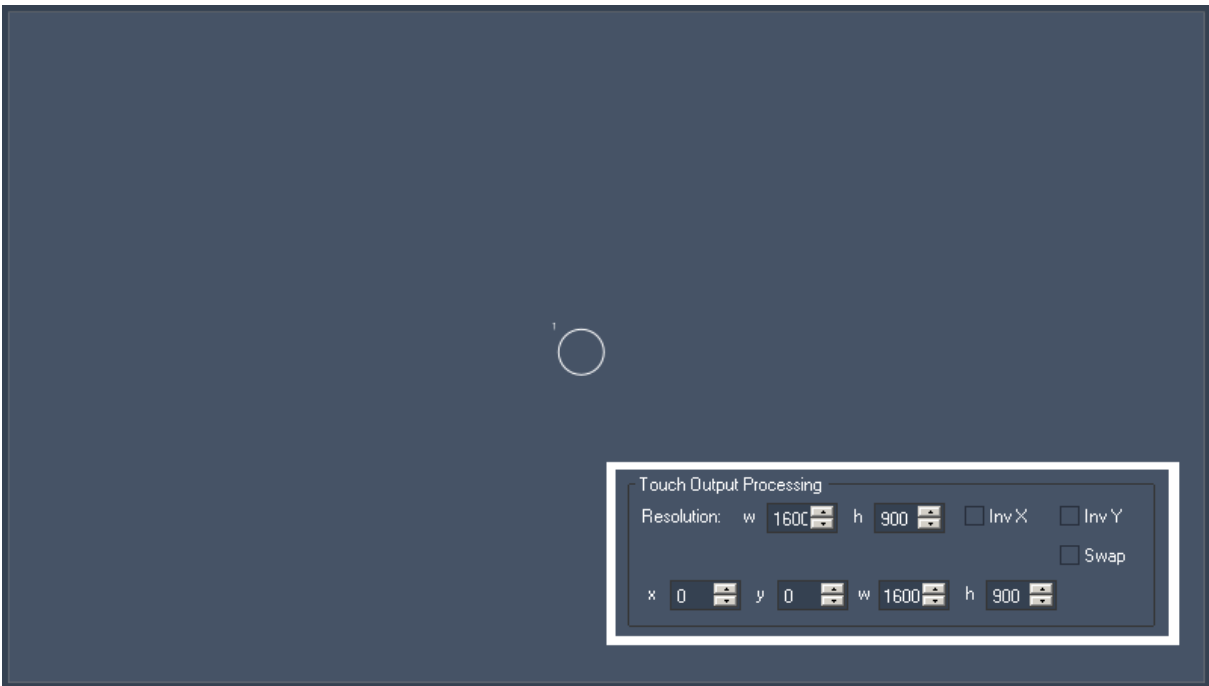

Image 1: There is no range conversion setup in the camera tracking tool. The point that is detected in the center of the camera image appears in the center of the Multitouch Panel.

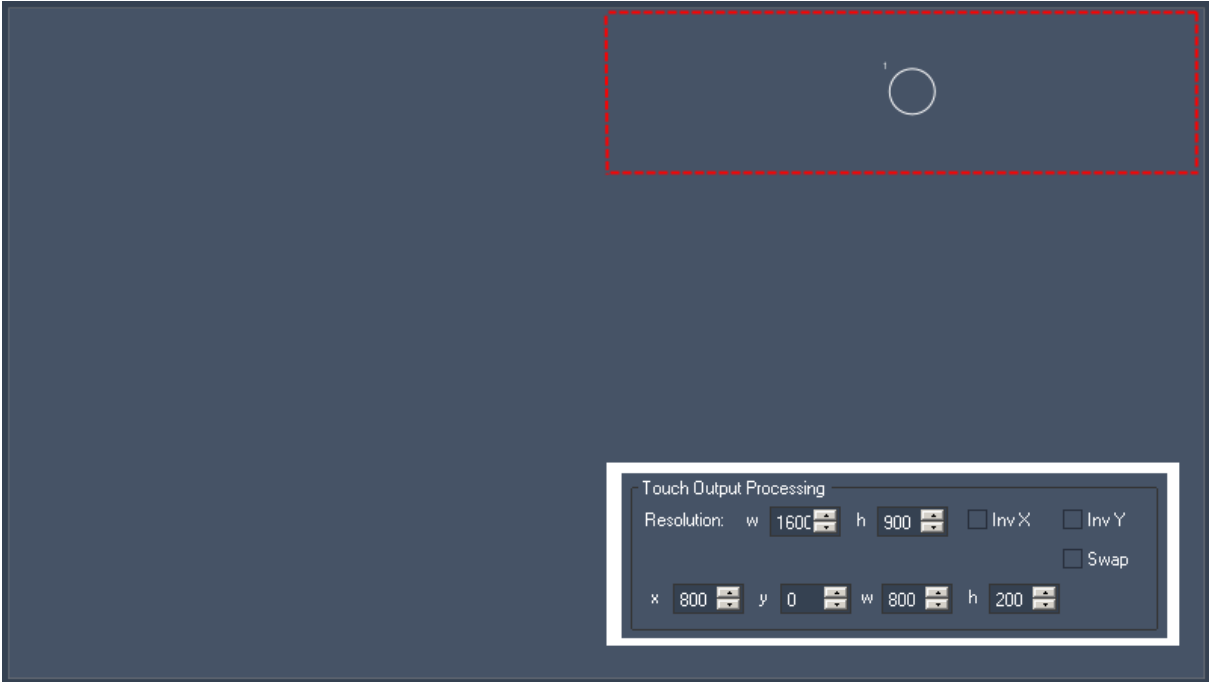
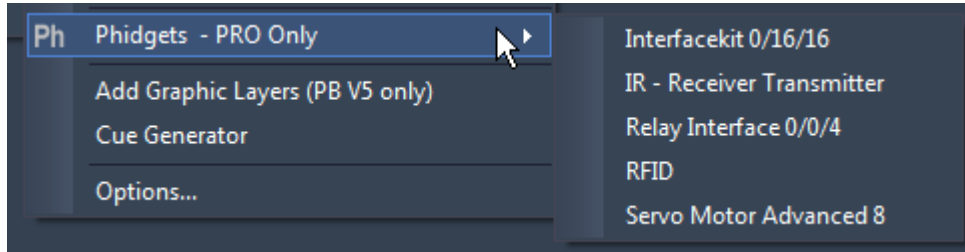

Image 2: There is a range conversion setup in the camera tracking tool. The region defined is shown by the red dashed rectangle. The point that is detected in the center of the camera image appears now in the center of the defined region instead of appearing in the center of the whole panel.

## 17.5.21 PHIDGETS

Phidgets are a set of "plug and play" building blocks for low cost USB sensing that can be controlled via the Widget Designer amongst others. The Phidgets are available via [www.phidgets.com](http://www.phidgets.com).

The following Phidgets are implemented already:



### [Interfacekit 0/16/16](#)<sup>1232</sup>

This tool allows receiving the status of 16 Digital Inputs sensing up to 30 VDC and controlling 16 Digital Outputs up to 30 VDC.

### [IR – Receiver Transmitter](#)<sup>1233</sup>

This Tool allows sending and receiving of IR Codes, e.g. to and from an old remote control.

Received IR Codes can be learned and stored with an Alias name to be used in commands to retransmit the code.

### [Relay Interface 0/4/4](#)<sup>1234</sup>

The PhidgetInterfaceKit 0/0/4 allows opening and closing 4 Relay Outputs for switching AC or DC power; the relays are Single Pole Double Throw (SPDT).

### [RFID](#)<sup>1234</sup>

The RFID (Radio Frequency Identification) Phidget reads RFID tags that are brought in close proximity to the reader and returns the tag identification number.

### [Servo Motor Advanced 8](#)<sup>1235</sup>

The Phidget Advanced Servo provides an interface to control 8RC analog servo motors.

### 17.5.21.1 INTERFACE KIT 0/16/16

(P/N 1012 –PhidgetInterfaceKit 0/16/16)

The Interface Kit 0/16/16 allows receiving the status of 16 Digital Inputs sensing up to 30 VDC and controlling 16 Digital Outputs up to 30 VDC.

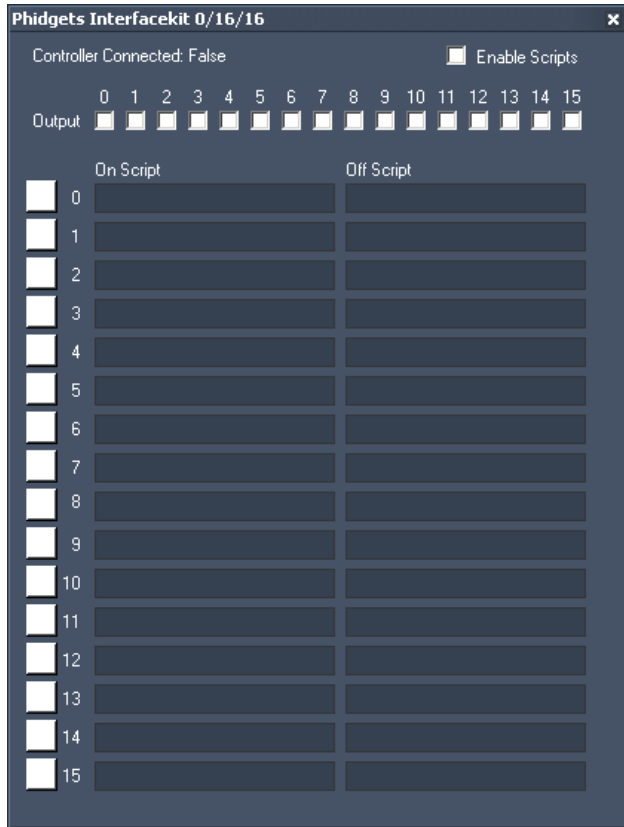

#### Setting up the digital inputs

The Digital Inputs are activated by an external voltage source, triggering on a wide voltage range - 4 to 30VDC. Depending on the status of the digital inputs dedicated scripts may be executed. To do so enter the commands in the On-Script and Off-Script text fields. The colored box in front of each input displays the input status: ON = green, OFF = white. The topic [Script Language](#)<sup>1254</sup> explains commands and how to use them in more detail.

Tick the check box [Enable Scripts] to enable the On- and Off Scripts.

To enable or disable the execution of a script triggered by the digital inputs via a command (e.g. by clicking a Custom Script Button), use [these commands](#)<sup>1421</sup>, you can as well control the outputs via commands.

#### Setting up the digital outputs

Each digital output you want to use needs to be enabled by ticking the check box according to the output.



### 17.5.21.2 IR - RECEIVER TRANSMITTER

(P/N 1055 – PhidgetIR)

This Tool allows sending and receiving of IR Codes, e.g. to and from an IR remote control. Received IR Codes can be learned and stored with an Alias name to be used in commands to retransmit the code.

This way any remote control IR code can be recorded and send via commands.

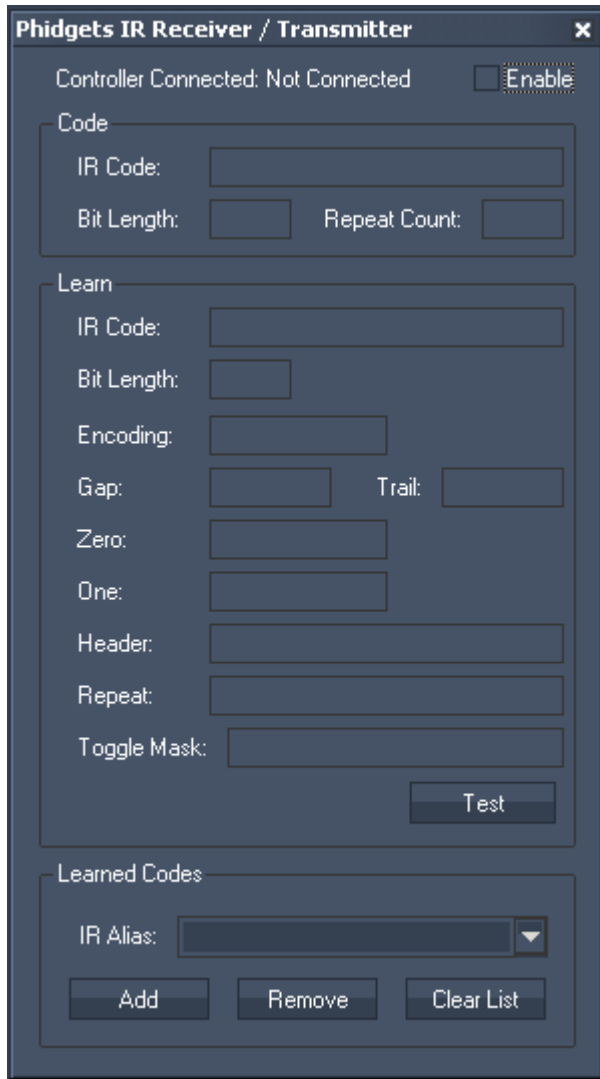

[These commands](#) <sup>1424</sup> are available to enable/disable the IR Phidget and to send the IR Alias code:

To link commands to incoming IR Codes, please use the [Phidget IR Script Node](#) <sup>1144</sup>.

### 17.5.21.3 RELAY INTERFACE 0/4/4

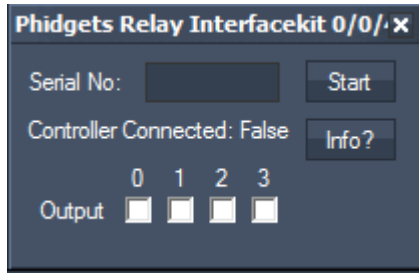

The PhidgetInterfaceKit 0/0/4 allows opening and closing 4 Relay Outputs for switching AC or DC power; the relays are Single Pole Double Throw (SPDT).

Maximum DC Switching Voltage: 100VDC  
 Maximum DC Switching Current: 5A  
 Maximum AC Switching Voltage: 250VAC  
 Maximum AC Switching Current: 10A

#### Connecting to the Relay Interface Kit 0/4/4

To connect to your Phidget InterfaceKit 0/4/4 you may press [Info?]. A pop-up dialog will show the serial numbers of all Phidget Interface Kit connected to your computer.

Enter the Serial Number of the device you want to connect to in the text field for “Serial No:”  
 Press [Start] to start the connection. The connection status will be shown below the Serial No.’s text field.

#### Changing the relay output status

To open and close the relay outputs you may tick the check boxes for the Outputs 0-4 inside this tool. They can be opened and close via [these commands](#)<sup>1422</sup> as well:

Please note:

The tool just controls the output status, you won’t get a feedback from the relay interface about the its real state.

### 17.5.21.4 RFID

(P/N 2002 - PhidgetRFID Kit)

The RFID (Radio Frequency Identification) Phidget reads RFID tags that are brought in close proximity to the reader.

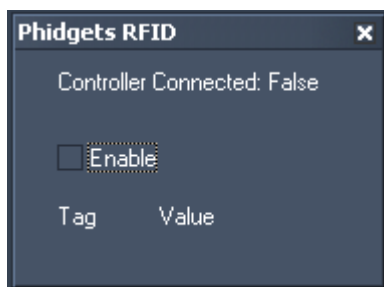

To enable the RFID Phidget Controller, please activate the check box.

[These commands](#)<sup>1424</sup> are available to enable/disable the RFID Phidget Controller:

To link commands to incoming RFID Codes, please use the [Phidget RFID Script Node](#)<sup>1145</sup>.

Please note:

It is possible that the Phidgets RFID do work only under Win7.

App hang has occurred on XP when a RFID Tool and RFID Script Node Property Window is open at the same time

### 17.5.21.5 SERVO MOTOR ADVANCED 8

(P/N 1061 - PhidgetAdvancedServo 8-Motor)

The Phidget Advanced Servo provides an interface to control 8RC analog servo motors.

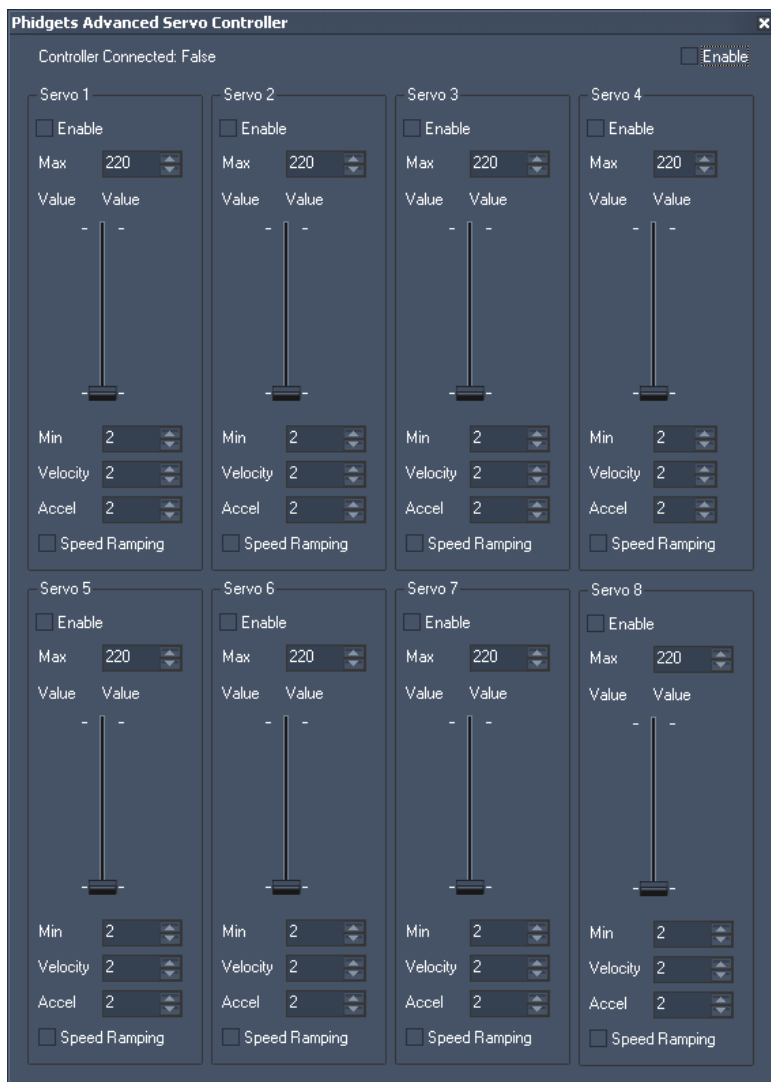

To enable the Advanced Servo Controller, please activate the check box top right.

[These commands](#)<sup>1420</sup> are available to enable/disable the motors and to change their acceleration, maximum velocity and position.

## 17.5.22 PROJECTOR CALIBRATION MANAGER

The Projector Calibration Manager is a Tool that allows to setup the connection between a [Calibration Link](#)<sup>747</sup> and other Pandoras Box software components. It is a fundamental item in the entire Re-Calibration process.

### The principle behind "Re-Calibration"

Currently only projections onto 2D-planes can be re-calibrated. The automation for 3D structured screens will follow. However, the general principle behind the calibration applies to any screen shape.

The fibre cable ends are mounted into the screen in the below described way. Then the projector setup is done as usual, followed by the warping or keystone step and / or softedge. Now, the image fits onto the screen. After a while, this might not be the case anymore, because the projector or the screen have moved. A typical scenario is a lamp change for a projector in a fixed installation. It is important that the projector still covers about 90% of the screen area. At least the projector needs to hit all calibration points.

This is when the Calibration Link is used as the screen- /projector-shift can be evened out with an automated re-calibration. This works with fiber cables measuring the light from the projector which projects different testpattern. The process does not include any cameras, only fibre cables and the Calibration Link. Based on these light measurements, the exact pixel location can be determined and necessary changes can be applied (automatically) to Pandoras Box software.

In short, the re-calibration is not an automated warping for the first setup. Once the projectors are setup by a technician who knows the system but a projector- or screen-shift has occurred, the re-calibration allows anybody to adjust the new output offset within a couple of minutes. The entire process can be started with one button click and no further manual settings are necessary. This is useful when the installation is serviced by staff who does not know how to reset the warp and blend properly.

The pixel accuracy that can be achieved in a best case scenario is 1mm / +- 1pixel accuracy.

There are different modes for both, 2D and 3D re-calibration, some are restricted to Server features whilst others are accessible for Pandoras Box Player as well.

Currently, the calibration points are fibre tips. However, in the near future, they can be alternatively replaced with markers or digital markers seen by cameras.

### Mounting the fibre cables

The Calibration Link is a device that allows to measure the light intensity levels of a 1mm fiber cable. The Re-Calibration process is based on these measurements. Hence, the quality of light transmission effects the quality of the process significantly.

The cable ends are mounted into the screen in a way that the fibers "look" straight at the projector to catch as much light as possible. The more offset the cable ends have, the more precise the calibration can be. At best, they are mounted into the corners.

A minimum number of four cables is required per projector. However one can be shared by several projectors. That is, if you have a softedge blend with two projectors then you can use six fiber cables (two in the overlap, and the other four near the corner of the screen).

Direct sun light needs to be avoided. By the very nature of the cables, they should be bend as less as possible. Also, the fibre cables that form a group for one projector should be equally long. The minimum length depends on the brightness of the projector. The longer the fibre cable is, the more light needs to hit the tip of the cable. As a rule of thumb, a 10m fiber cable requires at least 100lux. If you have 20m cables then you need to have a minimum brightness of 200lx and so on.

The cable ends must be clean and cut as straight as possible. It is highly recommended to use a professional fibre cutter to do so as other tools squeeze the fibre and reduce the transmission quality. Neither end from the glass itself must stick out from the cable sheath! Simply hold to isolated end into the fibre input and move slightly forwards until it withstands, then tighten the screw-able input.

It is recommended that the projector pixels are in a best focus position for all fiber points.

### Hardware and software setup

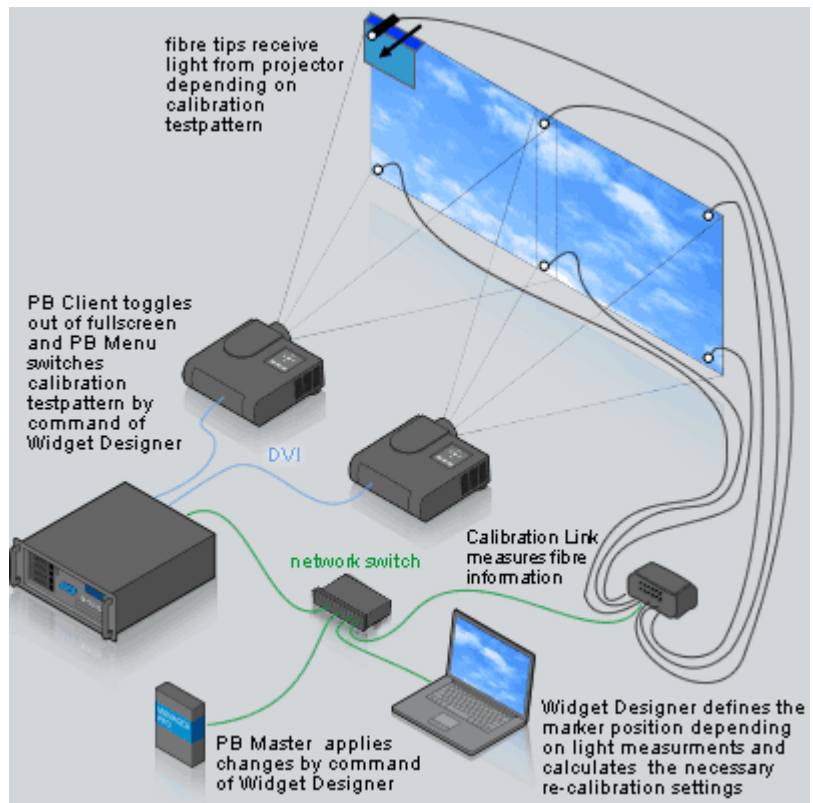

This depicts the communication between Pandoras Box (PB) components, Widget Designer (WD), Calibration Link and fibre cables.

First of all, a PB Master (e.g. a Manager) is connected with a PB Client (Server or Player) or a Server / Player run in stand-alone mode. The PB Menu runs in the background of the PB Client. Widget Designer may run on the same or a separate hardware and is connected to the PB Master and the Calibration Link. Fibre cables run from the Calibration Link to the screen and detect light from a projector that is connected to the PB Client.

1. The user starts the re-calibration process by clicking a button in WD.
2. WD tells PB Client via network to leave fullscreen.

3. WD tells PB Menu via network to start slide show of calibration testpattern.
4. Each testpattern is shown by the projector(s).
5. According to their position, the fibre cables receive a certain light amount per each testpattern.
6. The Calibration Link measures the light amount and transmits that information via network.
7. WD calculates the position from the fibre tips (markers) based on the light measurements for each testpattern.
8. WD calculates the necessary re-calibration settings.
9. WD applies the changes to the PB Master (via network). The changes are defined by the chosen mode:
  - a) WD calculates and applies new parameters for the Camera layer.
  - b) WD creates and applies a new warp object for the Output layer.
10. WD toggles the PB Client into fullscreen mode. The re-calibration process is finished within a few minutes.

### Software components

The following software components are needed and should be connected to each other:

- a running Pandoras Box master with Camera Layer / Output Layer settings for the Client
- a running Pandoras Box client
- a running PB Menu on the client
- for some modes, an installed Warper on the client
- a running Widget Designer project with the following two nodes and a tool

Create > Nodes > Input > Devices > [Calibration Link](#)<sup>989</sup> - one node per Calibration Link device

Create > Nodes > Input > Pandoras Box > System Menu (or search for PB Menu) - one node per client

Tools > Projector Calibration Manager



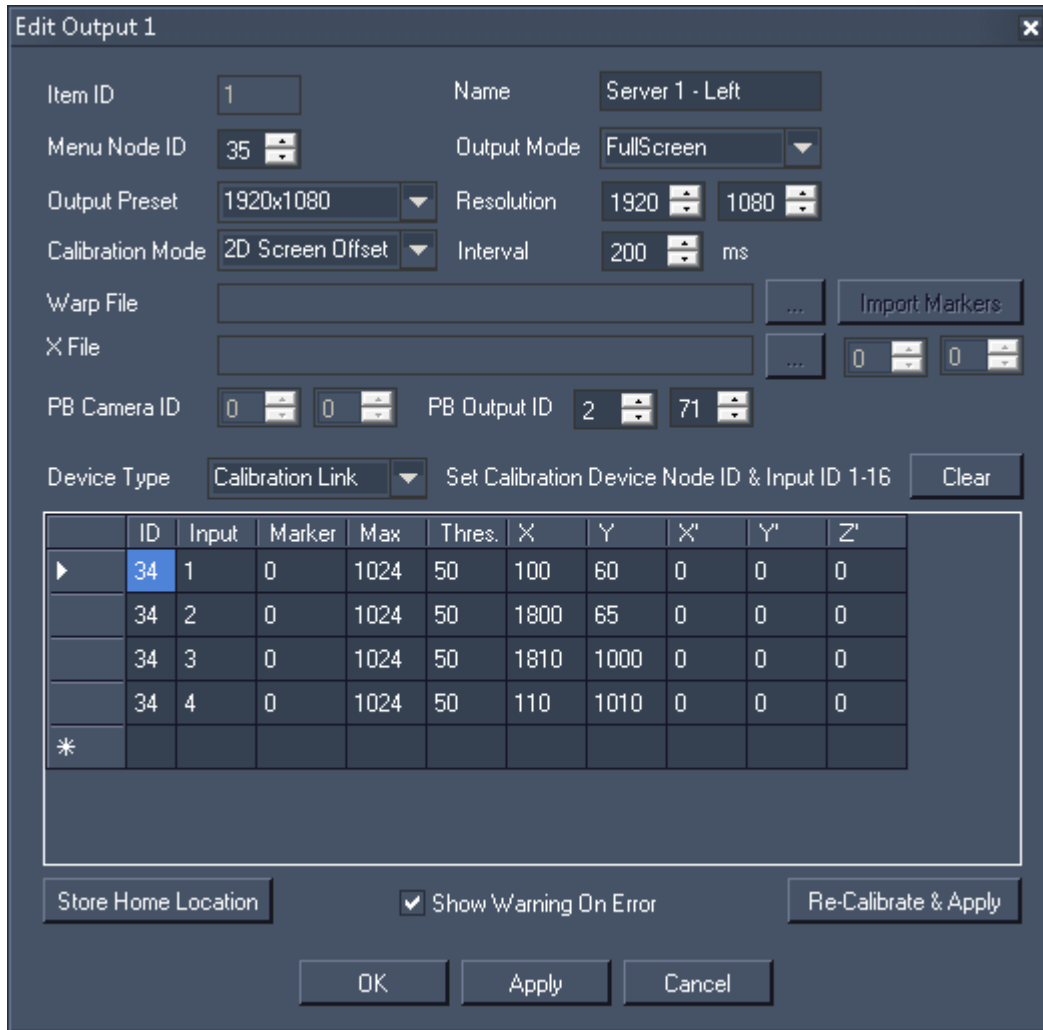

**Item ID**

The internal ID cannot be edited.

**Name**

Choose a name for the output.

**Menu Node ID**

Enter the Node ID from the PB Menu node. Within the node itself, the IP address from the client must be entered.

**Output Mode**

Choose the according output mode according to the client's graphics card settings.

**Output Preset and Resolution**

Choose the resolution per output according to the client's graphics card settings. You may use the preset list or enter a custom (pixel accurate) custom resolution.

**Calibration Mode**

Choose the calibration mode you wish to use.

**2D Screen Offset** (implemented and tested) - This mode the most simple one. It modifies the X & Y offset parameters in the Output Device Layer in the master software to offset its warp object. The changes are based on the average offset of the projectors original home position and its new position. No scaling or rotation is applied in this mode.

**2D Planar Perspective** (implemented and tested) - This mode opens the defined warp file and modifies the mesh according to the projector changes (X & Y offset, rotation, size and perspective transformation). A new warp file is being generated, saved under the given name and applied to the output in the master software.

**3D Planar Calibration** - (for future use) - This mode will use the 2D planar calibration method of Pandoras Box Warper. In this case the fiber points and the 4 coplanar (!) markers must match. The result of this process is that a new Camera Position will be calculated and applied in the Pandoras Box master.

**3D Object Calibration** - (for future use) - This mode will use the 3D pose calibration method of Pandoras Box Warper. In this case the fiber points and the 4 non-coplanar (!) markers must match. The result of this process is that a new Camera Position will be calculated and applied in the Pandoras Box master.

### Interval

This interval determines the calibration image update rate. The default value is 200ms and can be increased when the network performance does not allow to change the calibration images that fast.

### Warp and X File

Depending on the chosen Calibration mode, you are asked to name a Warp and X file. Click the [...] icon to choose the file directory on the client. For the X file, please enter the File and Folder ID used in the Pandoras Box master.

The Import Markers button is for future use.

### PB Camera and Output ID

Depending on the chosen Calibration mode, select the Site and Device ID (as seen in the PB master's Devices tab) for the camera or output layer.

### Device Type

For future use. The current Re-Calibration process is based on the Calibration Link's measurements. Later, a camera-based process will be possible too.

### PB Camera and Output ID

In order to get the home position data, a first initial calibration routine is required to calculate the pixel position of each fiber point per projector.

### Calibration Point List

Create an entry for each Calibration point i.e. fibre tip. The order does not matter.

**ID** - the ID from the Calibration node

**Input** - the input from the Calibration device to which the cable is attached

**Marker** - the ID from a Marker in the Warper (only necessary for some Calibration modes)

**Max:** the maximum allowed brightness value as seen in the Calibration node's properties. The default value is 1024 and can be reduced to your expected value for a white pixel. If then a value above the maximum is measured, you know, that something unexpected occurred during the calibration process, e.g a moving light hit the screen.

**Threshold** - the minimum value difference between "white" and "black". Note that lowering the threshold might result in entirely wrong re-calibration results due to misinterpretations. Due to light noise, the default threshold of 50 is reasonable. Please read below passage "Possible error messages".

**X, Y** - The stored X and Y position per calibration point after the button "Store Home Position" was clicked. You may modify the number by clicking in the field and typing.

**X', Y' and Z'** - The new X, Y and Z position per calibration point after the button "Re-Calibrate and Apply" was clicked.



number It is important to note that the physical fiber point location should not be changed after the home position has been initialized and stored.

### **Store Home Position**

The process to find the home position is done by projecting a series of black and white horizontal and vertical images. This process takes minimum 30 sec per projector (the time depends on the systems signal latency and network speed). As a result the X and Y positions are stored in the above described Calibration Point List.

### **Re-Calibrate and Apply**

The re-calibration process is done in the same way as finding the "Home Position". As a result the X, Y and Z positions are stored in the above described Calibration Point List. Depending on the chosen Calibration Mode, the necessary changes are calculated and applied.

### **Possible error messages**

To find a "Home Position" or "Re-Calibrate Position" a series of black and white horizontal and vertical images is projected. With pure logical combination Widget Designer then determines where the fibre tip is located.

0,0 is the X and Y pixel position for the left upper corner. 1920,1080 would be the right bottom corner for an HD projector.

This entire process requires that "white" and "black" can be clearly distinguished. The above mentioned "Threshold" parameter in the Calibration Point List defines this minimum value difference.

If the minimum is not reached, the Calibration process fails and gives an according warning. Possible reasons why a black pixel cannot be distinguished from a white one could be that black is too bright or white is too dark or even black equals white:

- too much (side) light on screen that raises the value for black
- broken projector lamp
- poor cable transmission quality
  - broken Calibration Link
  - broken cables
  - too long cables
  - cables bend
  - cable tips dusty, dirty

In the worst case, the projector moved so much that its light does not hit the fibre tips any more. So before starting the process, ensure that the projector covers all of its related fiber points as well as all of its dedicated screen-space.

The minimum values in the Calibration Link node for white should be above 100, for black 30-40 and most importantly, the difference between white and black should be around 30-120.

If your value for white exceeds 1024 you may set the Calibration Link to coarse mode. It roughly doubles the value range. If you need to do that, open the Calibration Link and find a dip switch on the circuit board. If you need assistance, please contact coolux support.

### 17.5.23 ADD LAYERS TO PANDORAS BOX

This tool allows you to easily add one or several new graphic or video layers to the PB V5 Master Device (and its connected clients) directly from within the Widget Designer.

Please note:

This tool does not work if connected to a PB Master Device below Version 5. The maximum number of supported layers can not be exceeded, e.g. a Server LT provides 8 video layers, thus only graphic layers can be added to it. The number of supported layers per device can be found in the chapter [Product Overview](#)<sup>65</sup>.

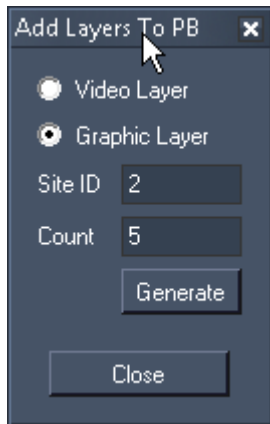

[Video Layer] / [Graphic Layer]:

Choose whether you like to add video or graphic layers.

[Site ID]:

Enter here the ID of the site to which new layers should be added.

[Count]:

Enter here the amount of layers you want to add to the specific site.

[Generate]:

Press [Generate] in order to generate the specified amount of layers to the site. Depending on the amount, this may take a while and prevent the Master from reacting.

### 17.5.24 ARRAY ALIGN LAYERS

This tool allows you to arrange several graphic or video layers from your PB Master Device and its connected clients to form a pattern - a line (1D), a rectangle (2D) or a rectangular box (3D). This kind of arrangement can be done from within the Widget Device faster and easier. Please read the [next topic](#)<sup>1244</sup> if you are interested in a circular alignment.

Please note:

It is recommended to use this tool with a PB Master Device Version 5.

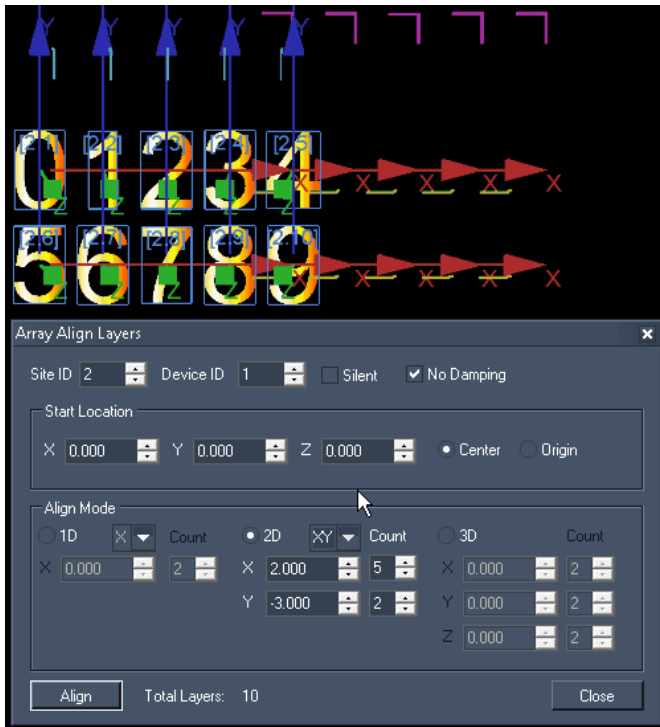

[Site ID] and [Device ID]:

Enter here the ID of the site and the starting device to address the layers which should be arranged.

[Silent]:

Tick the check box if the generated position values should not be entered as active values, but silent values.

[No Damping]:

Tick the check box if the position values should be applied instantly without the Pandoras Box setting for Translation Smoothing.

This damping time can be adjusted in the [site's Inspector](#)<sup>206</sup>.

[Start Location]:

Enter the X, Y, Z position and choose whether the starting point should be centered or not.

[Align]:

Set the radio buttons to form a line (1D), a rectangle (2D) or a rectangular box (3D). The X, Y, Z values apply for the offset between the layers whereas "Count" defines, how many layers are influenced. In the depicted example the offsets between the 5 horizontal layers are set to 2 and the vertical offset to -3, in total 10 layers (2.1 to 2.10) are arranged.

Please note that the positive X direction points to the right side, the positive Y direction points to the bottom and Z points into the display.

### 17.5.25 CIRCLE ALIGN LAYERS

This tool allows you to arrange several graphic or video layers from your PB Master Device and its connected clients to form a circular pattern. This kind of arrangement can be done from within the Widget Device faster and easier.

Please read the [previous topic](#)<sup>1243</sup> if you are interested in an array alignment.

Please note:

It is recommended to use this tool with a PB Master Device Version 5.

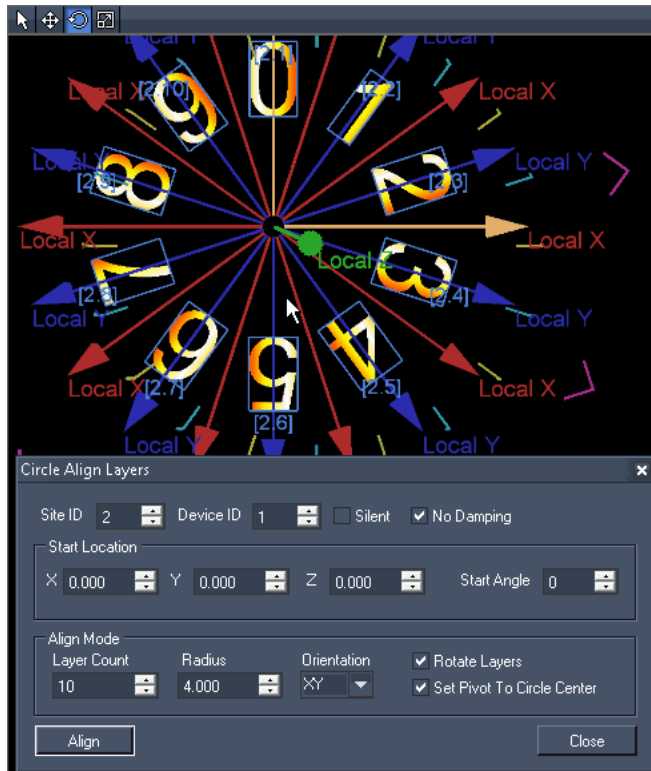

[Site ID] and [Device ID]:

Enter here the ID of the site and the starting device to address the layers which should be arranged.

[Silent]:

Tick the check box if the generated position values should not be entered as active values, but silent values.

[No Damping]:

Tick the check box if the position and rotation values should be applied instantly without the Pandoras Box setting for Translation and Rotation Smoothing.

These damping times can be adjusted in the [site's Inspector](#)<sup>206</sup>.

[Start Location]:

Enter the X, Y, Z position for the starting point. The "Start Angle" defines where the first layer is positioned.

[Align Mode]:

The "Layer Count" influences how many layers are arranged in a circular pattern. "Radius" enlarges the size of the formed circle. "Orientation" gives the possibility to span the circle in a XY / YZ / XZ plane.

In the image the option "Rotate Layers" is activated, the layer's lower sides do not face down any more but towards the circle's center.

"Set Pivot To Circle Center" was ticked as well. The Rotation Pivot Point is positioned in the circle's center. Now, a constant rotation can be applied, for example.

## 17.5.26 CUE GENERATOR

The Cue Generator Tool allows you adding cues into a timeline in Pandoras Box Master Device.

This can be done in two different ways:

- Arranging a specific amount of new cues evenly over a time period.
- Arranging a specific amount of new cues with intervals.

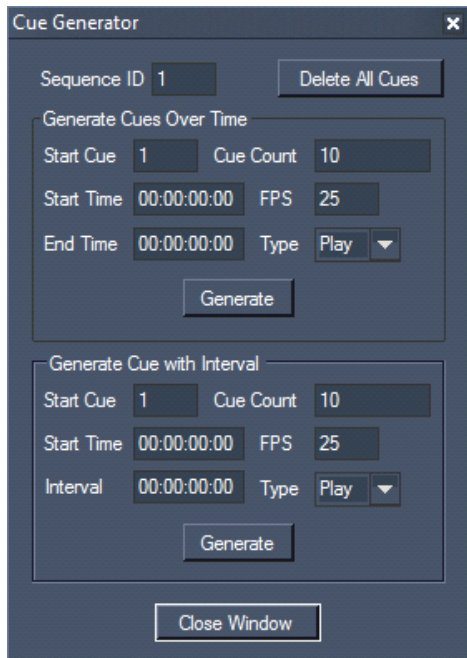

[Sequence ID]

Enter here the ID of the sequence in which you want to add new cues.

### Generate Cues Over Time

[Start Cue]

Enter here the ID for the first cue that will be added.

[Cue Count]:

Enter here the amount of cues that will be added.

[Start Time]:

Enter here the time at which the first cue will be placed, in the format (hh:mm:ss:ff).

[End Time]:

Enter here the time at which the last cue will be placed, in the format (hh:mm:ss:ff).

[FPS]:

Enter here the frame rate the sequence is set to in Pandoras Box (FPS = Frames per second), see [Sequence Inspector](#)<sup>200</sup>.

[Type]:

Enter here the type of the new cues: Play, Pause or Stop.

### Generate Cue with Interval

[Start Cue]

Enter here the ID for the first cue that will be added.

[Cue Count]:  
Enter here the amount of cues that will be added.

[Start Time]:  
Enter here the time at which the first cue will be placed, in the format (hh:mm:ss:ff).

[FPS]:  
Enter here the frame rate the sequence is set to in Pandoras Box (FPS = Frames per second), see [Sequence Inspector](#)<sup>200</sup>.

[Interval]:  
Enter here the time interval after which the next cue will be added to the timeline, in the format (hh:mm:ss:ff).

[Type]:  
Enter here the type of the new cues: Play, Pause or Stop.

### 17.5.27 VIDEO LOGGER

The Video Logger allows logging the timeline of Pandoras Box. The feature is useful when clients ask for a playback documentation, e.g. what media was seen for how long.

Please see below a showcase timeline with 3 video containers programmed on two layers. The cues are dispensable.

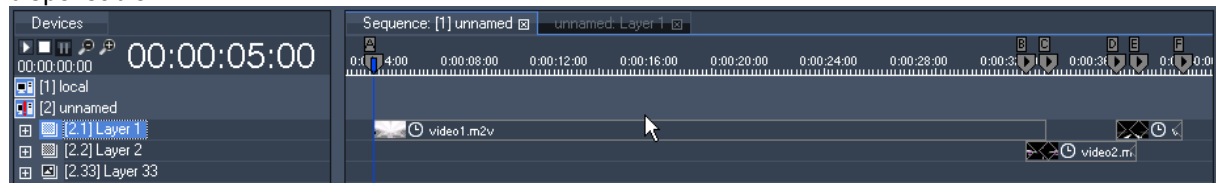

When importing the log file into a tabulation program like Excel from Microsoft, the result could look like this. For documentation reasons the cues where inserted into the table as well.

	Time	Descript.	Site ID	Device ID	Folder ID	File ID	FilePath	Starttime (hh:mm:ss)	Duration	Total Sec.
A	10:22:59	MediaLog	2	1	-1	-1	None	10:22:36	00:00:22	22.5
B	10:23:28	MediaLog	2	2	-1	-1	None	10:22:36	00:00:51	51.5
C	10:23:29	MediaLog	2	1	10	1	c:\video1.m2v	10:22:59	00:00:29	29.9
D	10:23:32	MediaLog	2	1	-1	-1	None	10:23:29	00:00:02	2.9
E	10:23:33	MediaLog	2	2	10	2	c:\video2.m2v	10:23:28	00:00:04	4.9
F	10:23:35	MediaLog	2	1	10	3	c:\video3.m2v	10:23:32	00:00:02	2.9

At time 0:00 the video logging in Widget Designer was started, 22.5 seconds later the first container on the first layer started. In other words, and this is what the first line in the table tells us, for 22.5 seconds nothing was rendered on that layer.

The next line informs that nothing was seen on the second layer for 51.5 seconds.

Line C states that the file "video1.m2v" saved directly on hard drive C:/ was played back on the first layer (site 2 - device 1) for 29.9 seconds. The duration is given in seconds and in time code language. As well the Folder and File ID (setup in the [File Inspector](#)<sup>190</sup>) is logged. When no IDs are assigned "-1" will be saved.

This image shows the Video Logger from Widget Designer. The Video Logger was set up to log Layer 1 and 2 on Site 2. The trigger for the opacity parameter was set to 0.

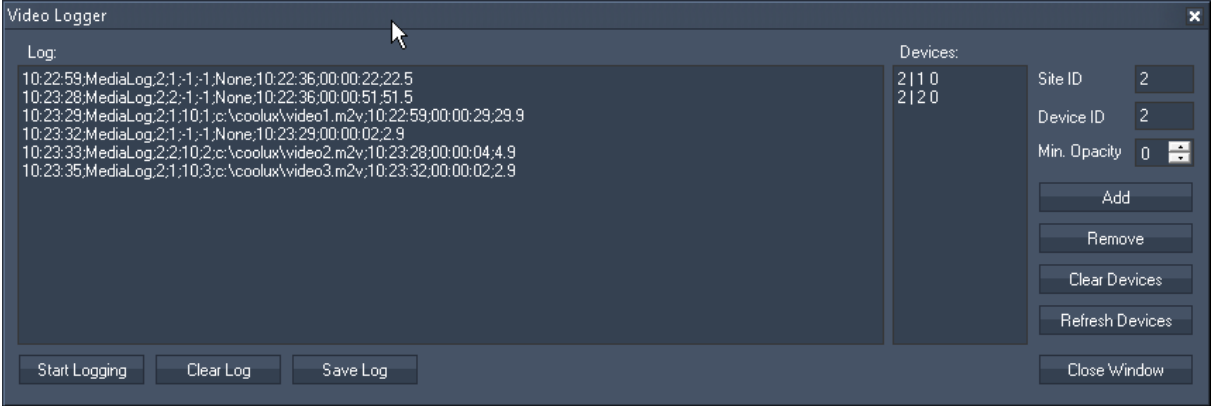

[Site ID] and [Device ID]

Enter here the ID of the site and the device that should be logged. After setting up the opacity click "Add" to adjoin the layer to the Video Logger's list.

[Min. Opacity]

As soon as a layer exceeds the minimum opacity a log entry is generated.

[Add]

First set up the site and device ID and the opacity trigger value, then click "Add" to adjoin the layer to the Video Logger's list.

[Remove]

If you like to erase a layer with from the Video Logger's list, set up the site and device ID and click "Remove". The opacity value is of no importance.

[Clear devices]

Erases all layers from the Video Logger's list.

[Refresh Devices]

Refreshes the list of layers.

[Start Logging]

Defines a moment 0:00 and starts the logging process with the sequence of the Pandoras Master System that is connected to the Widget Designer.

[Clear Log]

Erases all log entries (without pausing the logging process). If you like to erase particular lines only you may as well select them with the mouse or keyboard and press the Delete key.

[Save Log]

Saves the log as a \*.csv file to a file path of your choice. When importing the csv into another program you may choose to use the semicolons as a separation symbol.

### 17.5.28 DEFAULT IMAGE SETTINGS

The Default Image Settings enables you to design the same custom look for all Faders and Custom Script Buttons. When the design is set up, all new items created will adopt to it.

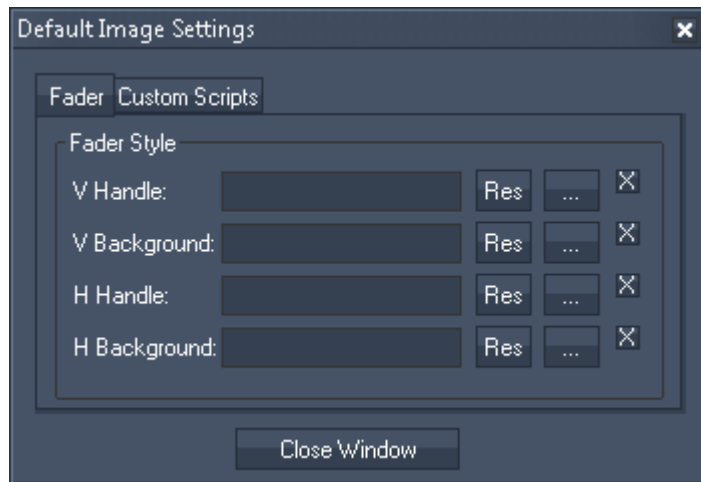

First, choose whether you like to setup a look for [Faders](#)<sup>925</sup> or [Custom Script Buttons](#)<sup>884</sup>.

The [Res] button opens the [Resource Manager](#)<sup>1249</sup>.

With [...] you may choose a specific file path.

[x] deletes the file entry again.

If you like to create individual looks per item the Resource Manager, described in the [next chapter](#)<sup>1249</sup>, might provide a faster workflow.



## 17.5.29 IMAGE RESOURCE MANAGER

The Resource Manager gives a fast and easy possibility to manage images within Widget Designer.

Example1: You are using images for controls like buttons and faders.

Example2: You are using the [WD Remote App](#)<sup>1185</sup> and send pictures from your Apple mobile device to WD.

The right-click menu lists the commands to add a file from your hard drive and to reset and refresh the resources within the Resource Manager. The "Delete" command works only for added images, not the ones that are displayed per default.

If you send images via the [WD Remote App](#)<sup>1185</sup>, they are displayed automatically in Style:Default, Control:User.

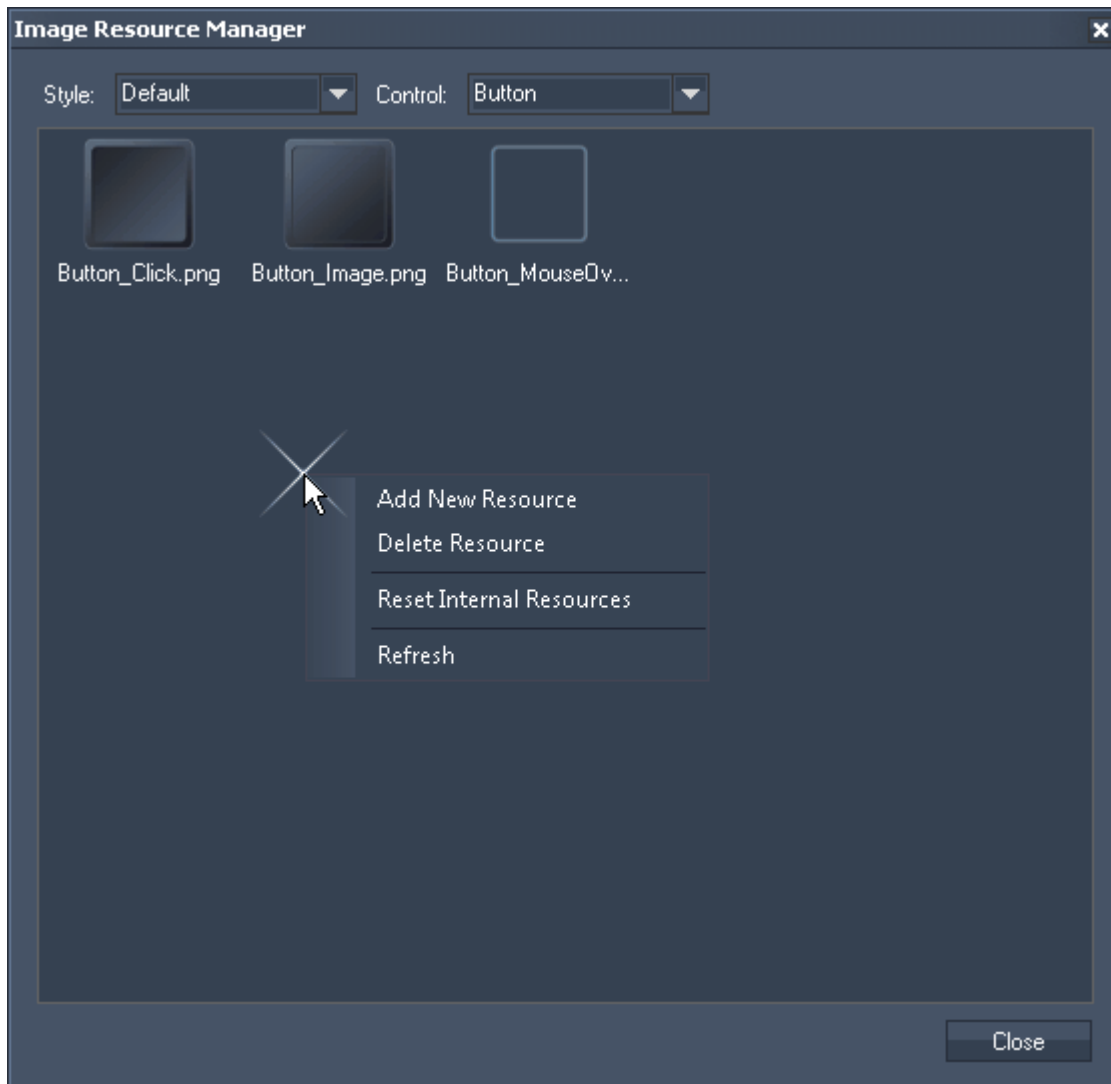

In the item's properties (e.g a fader) you may find a [Res] button which opens the Manager as well. Instead of opening a specific file path for each item separately you may use the Resource Manager for a faster access.

If you like to have the same custom look for all Faders and Custom Script Buttons you may design it once in the dialog "[Default Image Settings](#)<sup>1248</sup>" in the "Tools" menu and all new items created then will adopt to it.

### 17.5.30 SECURITY SETTINGS

With the Security Settings you may secure your Widget Designer project or the interface interaction with a password that is known to the project creator only. There are two features available, a Project File Protection and a User Interface Protection.

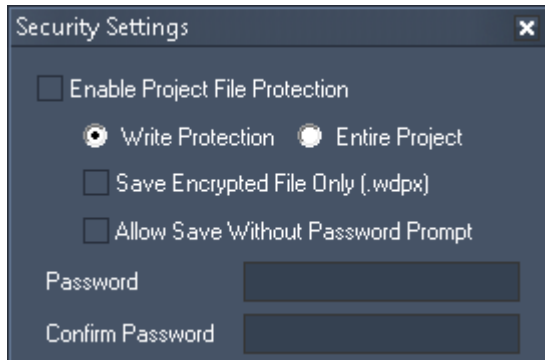

With an activated Project File Protection the entire project code is encrypted and can not be viewed with a text program. The project is saved (and delivered) as a \*.wdpx file. Depending on the chosen settings described below, Widget Designer protects certain actions and gives only access to them when the password is entered correctly.

The project password is different to a [page password](#)<sup>880</sup> that secures the access to a certain page. Both features can be combined with each other.

[Enable Password Protection]

Activates the protection feature. As well this allows to [lock the interface](#)<sup>1251</sup>.

[Write Protection]

The password must not be entered when the project is opened but only when the security settings are accessed, when the interface was locked and, optionally, when saving the project.

[Entire Protection]

The password must be entered when opening the project. In addition Widget Designer asks for it when the security settings are accessed, when the interface was locked and, optionally, when saving the project.

[Save Encrypted File Only]

If this option is NOT checked, the unencrypted \*.wdp version of the project is saved in addition to the encrypted \*.wdpx version. Please note that this can break the protection as the customer can then view the unsecured \*.wdp file!

[Allow Save Without Password Prompt]

With this option checked, the customer is allowed to make changes on the project and save it. The option is available for the "Write..." and "Entire Protection".

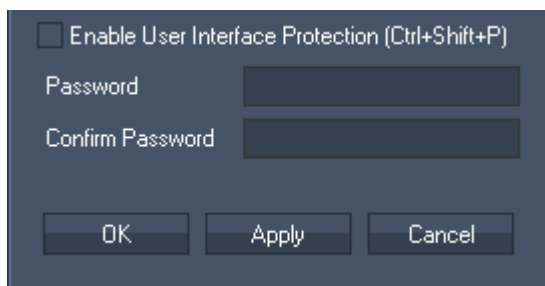

A second security feature is to protect your custom build interface from certain mouse or keyboard inputs. After enabling the User Interface Protection, Widget Designer cannot be toggled into Edit Mode anymore, all right-click menus and the Item Properties dialog are not available.

You may either use the shortcut Ctrl+Shift+P or the commands [WDLockGui](#)<sup>1346</sup> / [WDUnlockGui](#) to toggle

between the user interface protected and unprotected mode.

When switching to the unprotected (default) mode, a password must be entered. Choose one in the dialog and click "Apply".

Note there is an additional User Interface Lock functionality. When Tools > Lock Interface is chosen, a password dialog will pop up and restrict the access to the interface from Widget Designer. Alternatively, the command [WDLockInterface](#)<sup>1346</sup> can be called.

To continue working / using the interface, enter the same password as described above.

---

### 17.5.31 LOCK INTERFACE

When choosing the "Lock Interface" command from the Tools menu a password dialog will pop up and restrict the access to the interface from Widget Designer. The interface can be only unlocked when the correct password is entered.

The default password is empty. To customize it, choose a password in the "[Security Settings](#)"<sup>1250</sup> dialog from the Tools menu. Note that "User Interface Protection" does not need to be checked as this refers to another option as described in the chapter "[Security Settings](#)"<sup>1250</sup>.

### 17.5.32 OPTIONS ...

The Options tool allows to set advanced options to

- influence the performance of the node system
- load your own custom script plugin
- enable the Debug Logging to search for errors in your programming

#### Node System

When the user interface contains a lot of controls (labels, faders etc.) that are updated via output nodes, these updates could slow down the whole system performance. In these cases it could make sense to slow down the output node processing to gain overall system performance.

The disadvantage of slowing down the node processing is that all data given out by the nodes, for example Art-Net data, will be slowed down as well.

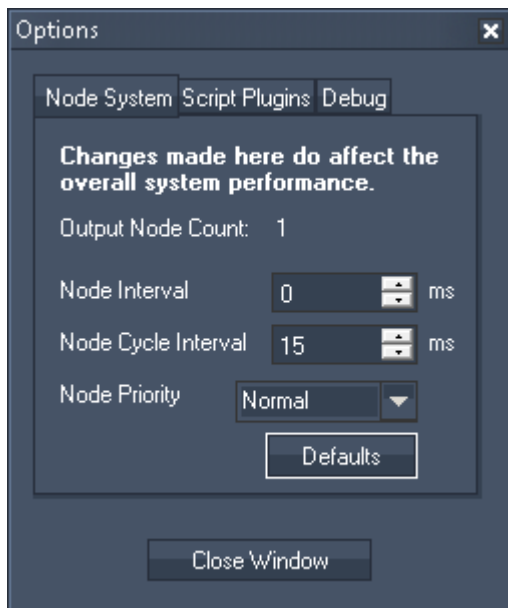

#### [Node Interval]:

By default the Node Interval is set to 0 ms. This means that there is no delay between the processing of values from one node to the following node. If setting the Node Interval to x ms, there will be a pause of x ms after the processing of each(!) node within one node chain.

#### [Node Cycle Interval]:

A node cycle interval is the interval, in which all output nodes are processed once, in other words after what time the Output updates / sends out its current value. By default the Node Cycle Interval is set to 15 ms. This means that after all output nodes are processed once there is a wait time of 15 ms, i.e 40 times per second. You may set this wait time to a different value to slow down or speed up the node processing interval.

#### [Node Priority]

In reference to process scheduling which controls the usage of the system's CPU for each single process (or thread), the node priority can be reduced or enforced. Please note that this might influence the entire operating systems and how other applications work.

#### [Defaults]:

Press this button to set the Node Interval and Node Cycle Interval back to their default values.

Since the Property pages request the node chain to update 25 times per second to display the current values, it is recommended to have all property dialogs closed during show mode for exact value processing.

#### Script Plugins

It is possible to integrate custom nodes and commands in Widget Designer.

If you are interested in a code sample for Visual Studio .NET, please contact our [support team](#). These sample project files are meant as an introduction for experienced developers who have knowledge in C# or Visual Basic .NET. The compiled \*.dll file containing your custom features need to be saved in the program directory under Data\Plugins, e.g. C:\Program Files (x86)\coolux\Widget Designer 4.5 Rev 642 \Data\Plugins\Scripts

## Debug

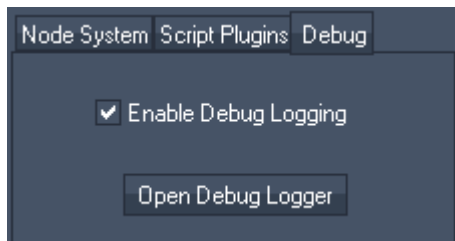

The Debug tab allows to start the Debug Logging which displays error messages in the "Debug Logger". It is recommended to turn the logging off during a show. The debugging feature helps to find errors in your programmed scripts. The list includes indications whether a command was wrongly spelled or includes a reference to a nonexistent ID. In addition to each entry, the time is logged. The log could look as following:

- 12/24/2013 11:53:14 - CMD Syntax Error - WDFaerUp
- 12/24/2013 11:53:31 - CMD "WDFaderUp" - FaderID does not exist

The text can be selected, copied and pasted into another dialog that lists where the command is originally programmed, e.g "CustomScript1". To open the "Find Entry" dialog, click "Edit" in the menu bar or right-click anywhere on the empty main background window and choose the command in the context menu. [More information](#)<sup>874</sup> about the "Find Entry" dialog and other debugging tools...

## 17.6 SCRIPT LANGUAGE

The built-in script language allows you to create customized routines of commands. Currently over [1000 commands](#)<sup>1260</sup> are available to control specific features of Pandoras Box, Widget Designer or other 3rd party products and protocols.

Commands can be used in the Main Windows Properties as Start-up Script or in some nodes, tools and many controls. For example you may assign one or more commands to a button click.

### How to enter a command using ScriptAssist or the drop-down list?

In order to use a command, open the control's Item properties, for example from a [Custom Script Button](#)<sup>884</sup>.

As soon as you start typing in the dedicated script text field, the feature ScriptAssist will automatically search for available commands that contain the typed characters and display the result in a list box. You do not need to know how exactly the command starts, typing "fader" will suggest "WDFader..." too. Type more characters to shorten the list or use the arrow keys (up and down) to select a command from it and press carriage return. The ESC key hides the list box.

Alternatively you may use the above drop-down list to scroll through all available commands. Press the button "Add" to copy the selected command from the drop-down list into the dedicated script text box.

Now, the placeholders need to be filled with concrete information, e.g. a numeric ID for a certain element that you would like to control or send values to; see some examples below. If you like to enter a path, select the dedicated placeholder and click the button "Path...". A dialog opens where you may choose a file. Click "Open" and the associated path will be copied, click "Add" and it will be entered into the command text field.

In addition you may use [variables](#)<sup>1193</sup>. Again, ScriptAssist offers a drop-down with all available variables.

Multiple commands (i.e. one script) can be executed by delimiting every command with a carriage return at the end of each command, simply hit the "enter" key. To delete a command, select it and press the "Delete" key. To delete a script text box entirely, click on the X button above each script.

### Command examples

For example, to set the opacity of Layer 1 on Server 1 to 128 you will need the following command:

```
DeviceSetParam, SiteID, DeviceID, ParamName, AbsoluteValue
```

Since this is only a template of the command, you will need to enter the numeric values for the SiteID, DeviceID, AbsoluteValue and the [ParamName](#)<sup>1256</sup> as plain text.

The correct command for this example would be written like this:

```
DeviceSetParam, 1, 1, Opacity, 128
```

Alternatively you may enter a [variable](#)<sup>1193</sup> name for any placeholder. Assuming you have an integer variable defined with the name varNumber and the value of 1, you could write the command as follows:

```
DeviceSetParam, varNumber, varNumber, Opacity, 128
```

### Advanced script techniques

Normally, you would enter a command and then fill out the placeholders (also called the "arguments" of a command). But there is also a technique that allows more direct programming. Still the syntax must conform, but as it is more open it can be used more flexible. You have direct script access to Variables and certain member values including nodes. This allows direct value assignment and item control. For further information and examples click the according links.

	direct command	corresponding common command
<a href="#">Variables</a> <small>1193</small>	<pre>Variable = Value varNumber = 123 ArrayVariable[Index] = Value varArray[5] = 123</pre>	<pre>VValue,VarName,Value VValue,varNumber,123 VSetArrayValue,VarName,Index,Value VSetArrayValue,varArray,5,123</pre>
<a href="#">Members</a> <small>1196</small>	<pre>MemberID.MemberValue = Value label1.text = Hello  fader2.value = 123 fader2.value = varNumber</pre>	<pre>WLabelText,ID,Text WLabelText,1,Hello WDFaderValue,ID,Value WDFaderValue,2,123 WDFaderValue,2,varNumber</pre>
<a href="#">Nodes</a> <sup>977</sup>	<pre>NodeID.Nodecommand node1.ResetPlaylist node2.PowerOn</pre>	<pre>WNodeCommand,NodeID,Args0,ArgsN WNodeCommand,1,ResetPlaylist WNodeCommand,1,PowerOn</pre>

The last row mentions [Node Commands](#)<sup>977</sup>. They cannot only access functions of a node but also the parameters. Please see the according chapter for more details.

Last but not least so called [Math Expressions](#)<sup>1199</sup> help you calculating values for variables, for instance, `varNumber = (1+2)*3`

### More information

WD commands can be written in upper or lower case style or mixed, with one exception:

Wherever you need to specify text-based parameters such as Opacity, the entry is case sensitive and must not have additional blanks (space characters).

Please see the next page for a [list with all parameter names](#)<sup>1256</sup> from Pandoras Box. Then, a [Command List](#)<sup>1260</sup> explains all available commands.

Advanced users can merge commands in [macros](#)<sup>1191</sup> or combine them with If-queries and for loops repetitions as explained in the topic [programming statements](#)<sup>1430</sup>.

### 17.6.1 PARAMETER LIST

This list helps with [commands](#)<sup>1254</sup> in Widget Designer where a so called "ParamName" needs to be defined (e.g. DeviceSetParam, SiteID, DeviceID, ParamName, AbsoluteValue)  
 The overview lists all names from parameters within Pandoras Box and their value range.

Please note:

- the name is case sensitive, e.g. "X Scale", not "x scale" or "XScale" etc.
- for [effects](#)<sup>319</sup> the entire name consists of the FX name and the FX parameter, both combined with a pipe "|" character (vertical bar) but no spaces before or after the pipe, e.g. "Blur|Mix" or "B&W Add|Invert"
- for [particle systems](#)<sup>182</sup> the name is composed like this "Particle System|Wind" for parameters directly underneath the system and "Particle System|Particle Emitter|Radius" for parameters underneath the emitter. (For revision lower 7832 the syntax was "Particle Emitter|Radius"
- if the value needs to be a decimal value, always use a point "." as separator not a comma ",", e.g. "0.5"

PARAMETER LIST PB V5		PARAMETER LIST PB V4.7	
Parameter	Value range	Parameter	Value range
Opacity	0-255	Opacity	0-255
Volume	0-2 <sub>579</sub> (= -96.00 - +6 dB)	Trans FX	0-244 (PB MS)
X Pos	-999.999 – +999.999	X Pos	0-65535
Y Pos	-999.999 – +999.999	Y Pos	0-65535
Z Pos	-999.999 – +999.999	Z Pos	0-65535
X Angle	-9999.99° – +9999.99°	X Rot	0-65535
Y Angle	-9999.99° – +9999.99°	Y Rot	0-65535
Z Angle	-9999.99° – +9999.99°	Z Rot	0-65535
X Rot Mode	0; 1	X Scale	0-65535
Y Rot Mode	0; 1	Y Scale	0-65535
Z Rot Mode	0; 1	Z Scale	0-65535
X Rot Speed	0-655535	Video Mode	0 (Stop)
Y Rot Speed	0-655535		64 (Pause)
Z Rot Speed	0-655535		128 (Play Once)
X Scale	-999.999 – +999.999		192 (Play Loop)
Y Scale	-999.999 – +999.999	Colour Fx	0-66 (PB MS)
Z Scale	-999.999 – +999.999	Colour 1	0-255
Rot Pivot X Pos	-999.999 – +999.999	Colour 2	0-255
Rot Pivot Y Pos	-999.999 – +999.999	Colour 3	0-255
Rot Pivot Z Pos	-999.999 – +999.999	Video Fx	0-221 (PB MS)
Scale Pivot X Pos	-999.999 – +999.999	Fx 1	0-255



Scale Pivot Y Pos	-999.999 – +999.999	Fx 2	0-255
Scale Pivot Z Pos	-999.999 – +999.999	Fx 3	0-255
Playback Transport	0 (Stop)		
	64 (1-127) (Play)		
	128 (Pause)		
	192 (129-255) (Loop)		
Playback Speed	0-255		
Inpoint	0-65535		
Outpoint	0-65535		
Blend Mode	0-6		
'FXName' 'FXParameter' (e.g. Blur Mix)	see <a href="#">here</a> <sup>328</sup> for more info		
Particle System 'PSPParameter' (e.g. Particle System Wind)	see <a href="#">here</a> <sup>184</sup> for more info		
Particle System Particle Emitter 'PEParameter' (e.g. Particle System  Particle Emitter Radius)	see <a href="#">here</a> <sup>184</sup> for more info		

Camera Layer (see <a href="#">here</a> <sup>589</sup> for all parameters)	
Proj. Mode	0; 1
Viewpoint X Pos	-999.999 – +999.999
Target X Pos	-999.999 – +999.999
FOV	-180.000 – +180.000
Near Plane	0-65535
Far Plane	0-65535
Aspect	0.000 – 6.000
X Offset	-999.999 – +999.999
Z Roll	-9999.99° – +9999.99°
RtClearColor Red	0-255
RtClearColor Alpha	0-255

Output Layer (see <a href="#">here</a> <sup>597</sup> for all parameters)	
Opacity	0-255
X Pos	-999.999 – +999.999
X Angle	-9999.99° – +9999.99°
X Rot Mode	0; 1
X Rot Speed	0-65535
X Scale	-999.999 – +999.999
Rot Pivot X Pos	-999.999 – +999.999
Scale Pivot X Pos	-999.999 – +999.999
Viewpoint X Pos	-999.999 – +999.999
Target X Pos	-999.999 – +999.999
FOV	-180.000 – +180.000
Near Plane	0-65535
Far Plane	0-65535
Aspect	0.000 – 6.000
X Offset	-999.999 – +999.999
Z Roll	-9999.99° – +9999.99°
RtClearColor Red	0-255
RtClearColor Alpha	0-255
KS L	0-65535
KS LR	0-65535
Lin X	0-65535
SE L	0.000 – 100.000%
SE LC	0.000 – 100.000%
SE L Marker	0.000 – 100.000%
State	0; 1

Light Layer (see <a href="#">here</a> <sup>582</sup> for all parameters)	
Light Intensity	0-255
Playback Transport	0 (Stop)
	64 (1-127) (Play)
	128 (Pause)
	192 (127-255) (Loop)
Playback Speed	0-255
Inpoint	0-65535
Outpoint	0-65535
Light Source X Pos	-999.999 – +999.999
Light Target X Pos	-999.999 – +999.999
Light Color Red	0-255
Light Angle	0.000° – 180.000°
Light Aspect	0.000 – 20.000
Light Z Roll	-9999.99° – +9999.99°
Near Plane	0-65535
Far Plane	0-65535
Light Tolerance	0.000 – 1.000
Shadow Softness	0-1000

Sonic Emotion Audio Track	
Sonic Volume	0-65535
X	0-65535
Z	0-65535
Playback Transport	0 (Stop)
	64 (1-127) (Play)
	128 (Pause)
	192 (127-255) (Loop)

## 17.6.2 COMMAND LIST

This topic lists all commands that are available in [Widget Designer](#)<sup>864</sup>. How they are used is explained in the [introducing topic](#)<sup>1254</sup>.

### ▼ DeviceSetParam

DeviceSetParam,SiteID,DeviceID,ParamName,AbsoluteValue

Example:

DeviceSetParam, 1,2,X Pos,3

Sets the X Position of Server 1, Layer 2 to the value 3. See here a list with all [parameter names](#)<sup>1256</sup>.

### ▼ DeviceSetParamRelative

DeviceSetParamRelative,SiteID,DeviceID,ParamName,RelativeValue

Example:

DeviceSetParamRelative, 1,2,Opacity, 100

Adds the value 100 to the [parameter](#)<sup>1256</sup> Opacity of Server 1, Layer 2.

### ▼ DeviceSetParamDirect

DeviceSetParamDirect,SiteID,DeviceID,ParamName,AbsoluteValue

Example:

DeviceSetParamDirect, 1,2,X Pos,3

Sets the X Position of Server 1, Layer 2 to the value 3 WITHOUT having translation smoothing applied in Pandoras Box, see [Device Inspector](#)<sup>206</sup>. Since PB 9088 all parameters can be smoothed, before this applied only to position, scaling and rotation. See here a list with all [parameter names](#)<sup>1256</sup>.

### ▼ DeviceSetParamSilent

DeviceSetParamSilent,SiteID,DeviceID,ParamName,AbsoluteValue

Example:

DeviceSetParamSilent, 1,2,X Pos,3

Sets the X Position of Server 1, Layer 2 to the value 3 WITHOUT setting the parameter active in PB if it was not active before. See here a list with all [parameter names](#)<sup>1256</sup>.

### ▼ DeviceSetParamDirectSilent

DeviceSetParamDirectSilent,SiteID,DeviceID,ParamName,AbsoluteValue

Example:

DeviceSetParamDirectSilent, 1,2,X Pos,3

This command combines the commands DeviceSetParamDirect and DeviceSetParamSilent:  
It sets the X Position of Server 1, Layer 2 to the value 3 WITHOUT having translation smoothing

applied in Pandoras Box, see [Device Inspector](#)<sup>206</sup> and WITHOUT setting the parameter active in PB if it was not active before.

See here a list with all [parameter names](#)<sup>1256</sup>.

### ▼ DeviceSetMedia

DeviceSetMedia, SiteID, DeviceID, FolderID, FileID

Example:

DeviceSetMedia, 1, 3, 2, 4

Assigns the media file with the File and Folder ID 2,4 to layer 3 of Site 1 (e.g. a Server).

### ▼ DeviceSetMesh

DeviceSetMesh, SiteID, DeviceID, FolderID, FileID

Example:

DeviceSetMesh, 1, 3, 2, 4

Assigns the mesh file with the File and Folder ID 2,4 to layer 3 of Site 1 (e.g. a Server).

### ▼ DeviceSetMediaByName

DeviceSetMediaByName, SiteID, DeviceID, MediaName

Example:

DeviceSetMediaByName, 1, 3, Testpattern/Calibrate.png

Assigns the media file with the name "Calibrate.png" from the subfolder "Testpattern" within the project folder to layer 3 of the Site 1 (e.g. a Server). If there is more than one file in the subfolder that holds this name, the first file is taken. If the file is not in a special subfolder, simply use "Calibrate.png". Please note that "MediaName" is case-sensitive.

### ▼ DeviceSetMeshByName

DeviceSetMeshByName, SiteID, DeviceID, MediaName

Example:

DeviceSetMeshByName, 1, 3, Objects/Cone.x

Assigns the mesh file with the name "Cone.x" from the subfolder "Objects" within the project folder to layer 3 of the Site 1 (e.g. a Server). If there is more than one file in the subfolder that holds this name, the first file is taken. If the file is not in a special subfolder, simply use "Cone.x". Please note that "MediaName" is case-sensitive.

### ▼ DeviceSetMediaParamByName

DeviceSetMediaParamByName, SiteID, DeviceID, ParamName, MediaName

Example:

DeviceSetMediaParamByName,1,3,Quad Media Overlay|Media1,Testpattern/Calibrate.png

Assigns the media file with the name "Calibrate.png" from the subfolder "Testpattern" within the project folder to layer 3 of the Site 1 (e.g. a Server) but not as the main media but the first media for the effect named "Quad Media Overlay".

If there is more than one file in the subfolder that holds this name, the first file is taken. If the file is not in a special subfolder, simply use "Calibrate.png". Please note that "MediaName" and "ParamName" is case-sensitive. "ParamName" consists of the name of the [effect](#)<sup>328</sup> followed by the character pipe (vertical bar) and the name of the media field (in most cases simply "Media").

### ▼ DeviceSetMeshParamByName

DeviceSetMeshParamByName,SiteID,DeviceID,ParamName,MediaName

Example:

DeviceSetMeshParamByName,1,3,FXName|Mesh1,Objects/Car.x

Assigns the mesh file with the name "Car.x" from the subfolder "Objects" within the project folder to layer 3 of the Site 1 (e.g. a Server) but not as the main mesh but the first mesh of the effect named "FXName".

If there is more than one file in the subfolder that holds this name, the first file is taken. If the file is not in a special subfolder, simply use "Car.x". Please note that "MediaName" and "ParamName" is case-sensitive. "ParamName" consists of the name of the effect followed by the character pipe (vertical bar) and the name of the mesh field.

### ▼ DeviceSetMediaParamByID

DeviceSetMediaParamByID,SiteID,DeviceID,ParamName,FolderID,FileID

Example:

DeviceSetMediaParamByID,1,3,Quad Media Overlay|Media1,2,4

Assigns the media file with the File and Folder ID 2,4 to layer 3 of the Site 1 (e.g. a Server) but not as the main media but the first media for the effect named "Quad Media Overlay".

### ▼ DeviceSetMeshParamByID

DeviceSetMeshParamByID

Example:

DeviceSetMeshParamByID,1,3,FXName|Mesh1,2,4

Assigns the mesh file with the File and Folder ID 2,4 to layer 3 of the Site 1 (e.g. a Server) but not as the main mesh but the first mesh of the effect named "FXName".

### ▼ DeviceSetMediaInSelection

DeviceSetMediaInSelection,FolderID,FileID

Example:

```
DeviceSetMediaInSelection,2,4
```

Assigns the media file with the File and Folder ID 2,4 to all layers that are currently selected.

### ▼ DeviceSetMeshInSelection

```
DeviceSetMeshInSelection,FolderID,FileID
```

Example:

```
DeviceSetMeshInSelection,2,4
```

Assigns the mesh file with the File and Folder ID 2,4 to all layers that are currently selected.

### ▼ DeviceSetParamInSelection

```
DeviceSetParamInSelection,ParamName,AbsoluteValue
```

Example:

```
DeviceSetParamInSelection,Opacity,255
```

Sets the Opacity of all selected Devices in PB to the value 255. See here a list with all [parameter names](#)<sup>1256</sup>.

**Please note:**

This command will only work with Pandoras Box Version 4535 or higher!

### ▼ DeviceSetParamRelativeInSelection

```
DeviceSetParamRelativeInSelection,SiteID,DeviceID,ParamName,RelativeValue
```

Example:

```
DeviceSetParamRelativeInSelection,Opacity,20
```

Adds the value 20 to the Opacity parameter of all selected Devices in PB. See here a list with all [parameter names](#)<sup>1256</sup>.

**Please note:**

This command will only work with Pandoras Box Version 4535 or higher!

### ▼ DeviceSetPreset

```
DeviceSetPreset,SiteID,DeviceID,PresetID1,PresetID2
```

Example:

```
DeviceSetPreset,1,3,2,4
```

Applies the Preset with the ID 2.4 to layer 3 of Site 1 (e.g. a Server). Please note that the command will not paste keys into the timeline but apply the value of the first key. See [Preset](#)<sup>253</sup>.

### ▼ DeviceFadeParam

DeviceFadeParam, SiteID, DeviceID, Param, StartValue, EndValue, Time

Example:

DeviceFadeParam, 2, 3, Opacity, 45, 108, 11

The parameter “Opacity” of layer 3 of site 2 starts at value 45 and increases gradually to 108 in 11 seconds. In addition the parameter will be activated and highlighted in red. See here a list with all [parameter names](#)<sup>[1256]</sup>.

### ▼ DeviceFadeToParam

DeviceFadeToParam, SiteID, DeviceID, Param, Value, Time

Example:

DeviceFadeToParam, 2, 4, Opacity, 103, 8

The parameter “Opacity” of layer 4 of site 2 will gradually change in 8 seconds to value 103. In addition the parameter will be activated and highlighted in red. See here a list with all [parameter names](#)<sup>[1256]</sup>.

### ▼ DeviceBringToFront

DeviceBringToFront, SiteID, DeviceID

Example:

DeviceBringToFront, 1, 3

Changes the layer order in Pandoras Box for Site 1 (e.g. a Server). Per default, the layer 3 is rendered after layer 1 and 2 and before layer 4, 5, 6 etc. With this command layer 3 is moved on top of all other layers. Please note that you might need to toggle the layers to be visible. See [Device Tree](#)<sup>[171]</sup>.

### ▼ DeviceMoveToFront

DeviceMoveToFront, SiteID, DeviceID

Example:

DeviceMoveToFront, 1, 3

Changes the layer order in Pandoras Box for Site 1 (e.g. a Server). Per default, the layer 3 is rendered after layer 1 and 2 and before layer 4, 5, 6 etc. With this command layer 3 is moved one step in front of layer 4 but stays behind layers 5, 6 etc. To move it in front all other layers, use the command `DeviceBringToFront, SiteID, DeviceID`. Please note that you might need to toggle the layers to be visible. See [Device Tree](#)<sup>[171]</sup>.

### ▼ DeviceMoveToBack

DeviceMoveToBack, SiteID, DeviceID

Example:

DeviceMoveToBack, 1, 3



Changes the layer order in Pandoras Box for Site 1 (e.g. a Server). Per default, the layer 3 is rendered after layer 1 and 2 and before layer 4,5,6 etc. With this command layer 3 is moved one step behind layer 2 but stays in front of layer 1. To move it behind all other layers, use the command `DeviceSendToBack, SiteID, DeviceID`. Please note that you might need to toggle the layers to be visible. See [Device Tree](#)<sup>171</sup>.

### ▼ DeviceSendToBack

`DeviceSendToBack, SiteID, DeviceID`

Example:

`DeviceSendToBack, 1, 3`

Changes the layer order in Pandoras Box for Site 1 (e.g. a Server). Per default, the layer 3 is rendered after layer 1 and 2 and before layer 4,5,6 etc. With this command layer 3 is moved behind all other layers. Please note that you might need to toggle the layers to be visible. See [Device Tree](#)<sup>171</sup>.

### ▼ AddVideoLayer

`AddVideoLayer, SiteID, Count`

Example:

`AddVideoLayer, 1, 3`

Adds three new Video Layers to Site 1 (e.g. a Server). This command depends on the Pandoras Box product, whilst a Server PRO is not limited to a maximum number of Video Layers, a Server STD or a Player are limited. See the [Product Overview](#)<sup>65</sup> and [Device Controls](#)<sup>296</sup>.

### ▼ AddGraphicLayer

`AddGraphicLayer, SiteID, Count`

Example:

`AddGraphicLayer, 1, 3`

Adds three new Graphic Layers to Site 1 (e.g. a Server). All Pandoras Box products have an unlimited number of Graphic Layers. See the [Product Overview](#)<sup>65</sup> and [Device Controls](#)<sup>296</sup>.

### ▼ RemoveVideoLayer

`RemoveVideoLayer, SiteID, DeviceID`

Example:

`RemoveVideoLayer, 1, 3`

Removes layer 3 from the Site 1 (e.g. a Server) if it is a Video Layer. This command does not just toggle the layer invisible, it deletes it entirely.

### ▼ RemoveGraphicLayer

`RemoveGraphicLayer, SiteID, DeviceID`

Example:  
RemoveGraphicLayer,1,3

Removes layer 3 from the Site 1 (e.g. a Server) if it is a Graphic Layer. This command does not just toggle the layer invisible, it deletes it entirely.

#### ▼ **ActivateAll**

ActivateAll

Example:  
ActivateAll

Activates all parameters of all layers of all servers within the Pandoras Box Project.

#### ▼ **ActivateSite**

ActivateSite,SiteID

Example:  
ActivateSite,1

Activates all parameters of all layers of site 1 within the Pandoras Box Project.

#### ▼ **ActivateDevice**

ActivateDevice,SiteID,DeviceID

Example:  
ActivateDevice,1,3

Activates all parameters of layer 3 of site 1 within the Pandoras Box Project.

#### ▼ **ActivateParam**

ActivateParam,SiteID,DeviceID,ParamName

Example:  
ActivateParam,1,3,X Scale

Activates the [parameter](#)<sup>1256</sup> X Scale of layer 3 of site 1 within the Pandoras Box Project.

#### ▼ **ClearAllActive**

ClearAllActive

Example:  
ClearAllActive

Clears all active parameters of all layers of all servers within the Pandoras Box Project.

---

**▼ ClearActiveSite**

ClearActiveSite,SitelD

Example:

ClearActiveSite,1

Clears all active parameters of all layers of site 1 within the Pandoras Box Project.

**▼ ClearActiveDevice**

ClearActiveDevice,SitelD,DeviceID

Example:

ClearActiveDevice,1,3

Clears all active parameters of layer 3 of site 1 within the Pandoras Box Project.

**▼ ClearActiveParam**

ClearActiveParam,SitelD,DeviceID,ParamName

Example:

ClearActiveParam,1,3,X Scale

Sets a clear active to the [parameter](#)<sup>1256</sup> X Scale of layer 3 of site 1 within the Pandoras Box Project.

**▼ ResetAll**

ResetAll

Example:

ResetAll

Resets all parameters of all layers of all servers within the Pandoras Box Project.

**▼ ResetSite**

ResetSite,SitelD

Example:

ResetSite,1

Resets all parameters of all layers of site 1 within the Pandoras Box Project.

**▼ ResetDevice**

ResetDevice,SitelD,DeviceID

Example:

ResetDevice,1,3

---

Resets all parameters of layer 3 of site 1 within the Pandoras Box Project.

### ▼ **ResetParam**

ResetParam,SiteID,DeviceID,ParamName

Example:

ResetParam,1,3,X Scale

Resets the [parameter](#)<sup>1256</sup> X Scale of layer 3 of site 1 within the Pandoras Box Project.

### ▼ **DeviceSelect**

DeviceSelect,SiteID,DeviceID

Example:

DeviceSelect,1,3

Selects layer 3 of Site 1 (e.g. a Server) within the Pandoras Box project: If other layers were selected before, they are now deselected. If you like to add layer 3 to the current selection, use the command `DeviceAddToSelection,SiteID,DeviceID`

### ▼ **DeviceUnselect**

DeviceUnselect,SiteID,DeviceID

Example:

DeviceUnselect,1,3

Unselects layer 3 of Site 1 (e.g. a Server) within the Pandoras Box project. If other layers were selected before, they are still selected.

### ▼ **DeviceAddToSelection**

DeviceAddToSelection,SiteID,DeviceID

Example:

DeviceAddToSelection,1,3

Selects layer 3 of Site 1 (e.g. a Server) and adds it to the current selection within the Pandoras Box project: If other layers were selected before, they are still selected. If you like to select solely layer 3, use the command `DeviceSelect,SiteID,DeviceID`

### ▼ **ClearSelection**

ClearSelection

Example:

ClearSelection

Clears the device selection within the Pandoras Box project.

### ▼ SeqSetTimecode

SeqSetTimecode,SeqID,HH,MM,SS,FF

Example:

```
SeqSetTimecode,2,00,05,22,12
```

Sets sequence 2 within the Pandoras Box project to the timecode 00:05:22:12 (hh:mm:ss:ff)

### ▼ SeqSetTimecodeF

SeqSetTimecodeF,SeqID,HH:MM:SS:FF

Example:

```
SeqSetTimecodeF,2,00:05:22:12
```

Sets sequence 2 within the Pandoras Box project to the timecode 00:05:22:12 (hh:mm:ss:ff). With this command the timecode can also be stored and recalled using a string [variable](#)<sup>1193</sup>.

### ▼ SeqSetTimecodeRelative

SeqSetTimecodeRelative,SeqID,HH,MM,SS,FF

Example:

```
SeqSetTimecodeRelative,2,00,05,22,12
```

```
SeqSetTimecodeRelative,2,00,-05,-22,-12
```

Adds an time interval of 00:05:22:12 (hh:mm:ss:ff) to the timecode of sequence 2 within the Pandoras Box project. If the timecode was at 00:01:02:03, it is now at 00:06:24:15.

The second example subtracts the same time interval again. The command is the same but in front of each time value there is a minus (-) symbol.

### ▼ SeqSetTimecodeRelativeF

SeqSetTimecodeRelativeF,SeqID,HH:MM:SS:FF

Example:

```
SeqSetTimecodeRelativeF,2,00:05:22:12
```

```
SeqSetTimecodeRelativeF,2,00:-05:-22:-12
```

Adds an time interval of 00:05:22:12 (hh:mm:ss:ff) to the timecode of sequence 2 within the Pandoras Box project. If the timecode was at 00:01:02:03, it is now at 00:06:24:15.

The second example subtracts the same time interval again. The command is the same but in front of each time value there is a minus (-) symbol.

With this command the timecode can also be stored and recalled using a string [variable](#)<sup>1193</sup>.

### ▼ SeqGotoCue

SeqGotoCue,SeqID,CueID

---

Example:  
SeqGotoCue,2,3

Sets the nowpointer of sequence 2 to the third cue.

#### ▼ **SeqNextCue**

SeqNextCue,SeqID

Example:  
SeqNextCue,1

Sets the nowpointer of sequence 1 to the next cue.

#### ▼ **SeqLastCue**

SeqLastCue,SeqID

Example:  
SeqLastCue,1

Sets the nowpointer of sequence 1 to the last cue.

#### ▼ **SeqNextFrame**

SeqNextFrame,SeqID

Example:  
SeqNextFrame,2

Sets the nowpointer of sequence 2 to the next frame ahead.

#### ▼ **SeqLastFrame**

SeqLastFrame,SeqID

Example:  
SeqLastFrame,2

Sets the nowpointer of sequence 2 to the last frame.

#### ▼ **SeqSetState,...,Play**

SeqSetState,SeqID,Play

Example:  
SeqSetState,SeqID,Play

Sets sequence 2 to Play.

---

**▼ SeqSetState, ..., Pause**

SeqSetState, SeqID, Pause

Example:

SeqSetState, SeqID, Pause

Sets sequence 2 to Pause.

**▼ SeqSetState, ..., Stop**

SeqSetState, SeqID, Stop

Example:

SeqSetState, SeqID, Stop

Sets sequence 2 to Stop.

**▼ SeqSetCuePlayMode**

SeqSetCuePlayMode, SeqID, CueID, Play/Pause/Stop/Jump/Wait

Example:

SeqSetCuePlayMode, 1, 17, Pause

Sets the play mode of cue 17 in Sequence 1 to "Pause".

The following cue play modes are available: Play, Pause, Stop, Jump and Wait.

**▼ SeqSetNextCuePlayMode**

SeqSetNextCuePlayMode, SeqID, Play/Pause/Stop/Jump/Wait

Example:

SeqSetNextCuePlayMode, 1, Pause

Sets the play mode of the next cue in Sequence 1 to "Pause".

The following cue play modes are available: Play, Pause, Stop, Jump and Wait.

**▼ SeqSetIgnoreNextCue**

SeqSetIgnoreNextCue, SeqID

Example:

SeqSetIgnoreNextCue, 1

The next cue in Sequence 1 will be ignored (cue turns orange).

**▼ SeqSetDoNotIgnoreNextCue**

SeqSetDoNotIgnoreNextCue, SeqID

Example:

SeqSetDoNotIgnoreNextCue,1

The next cue in Sequence 1 will not be ignored .

### ▼ SeqSetCueWaitTime

SeqSetCueWaitTime,SeqID,CueID,HH,MM,SS,FF

Example:

SeqSetCueWaitTime,2,3,00,05,22,12

This applies to Sequence 2 in Pandoras Box. The "Wait Time" of the Cue with ID 3 is set to 00:05:22:12 (hh:mm:ss:ff). See [Cue Inspector](#)<sup>204</sup>.

### ▼ SeqSetCueWaitTimeF

SeqSetCueWaitTimeF,SeqID,CueID,HH:MM:SS:FF

Example:

SeqSetCueWaitTimeF,2,3,00:05:22:12

This applies to Sequence 2 in Pandoras Box. The "Wait Time" of the Cue with ID 3 is set to 00:05:22:12 (hh:mm:ss:ff). The timecode can also be stored and recalled using a string [variable](#)<sup>1193</sup>. See [Cue Inspector](#)<sup>204</sup>.

### ▼ SeqSetCueJumpTargetTime

SeqSetCueJumpTargetTime,SeqID,CueID,HH,MM,SS,FF

Example:

SeqSetCueJumpTargetTime,2,3,00,05,22,12

This applies to Sequence 2 in Pandoras Box. The "Jump Target" of the Cue with ID 3 is set to 00:05:22:12 (hh:mm:ss:ff). Please note that the Cue must be a Jump Cue. See [Cue Inspector](#)<sup>204</sup>.

### ▼ SeqSetCueJumpTargetTimeF

SeqSetCueJumpTargetTimeF,SeqID,CueID,HH:MM:SS:FF

Example:

SeqSetCueJumpTargetTimeF,2,3,00:05:22:12

This applies to Sequence 2 in Pandoras Box. The "Jump Target" of the Cue with ID 3 is set to 00:05:22:12 (hh:mm:ss:ff). The timecode can also be stored and recalled using a string [variable](#)<sup>1193</sup>. Please note that the Cue must be a Jump Cue. See [Cue Inspector](#)<sup>204</sup>.

### ▼ SeqSetCueJumpCount

SeqSetCueJumpCount,SeqID,CueID,Count



Example:

```
SeqSetCueJumpCount,2,3,5
```

This applies to Sequence 2 in Pandoras Box. The "Repeat Count" of the Cue with ID 3 is set to 5. See [Cue Inspector](#)<sup>204</sup>.

### ▼ SeqSetCueName

```
SeqSetCueName,SeqID,CueID,Name1
```

Example:

```
SeqSetCueName,1,3,Scene4
```

This renames the Cue 3 of Sequence 1 in Pandoras Box to "Scene4". See [Cue Inspector](#)<sup>204</sup>.

### ▼ VGetSeqCueName

```
VGetSeqCueName,VarName,SeqID,CueID
```

Example:

```
VGetSeqCueName,Counter,1,3
```

This applies the name of Cue 3 from the Sequence 1 in Pandoras Box to the variable in Widget Designer named "Counter". If the cue name includes letters, the Variable's type must be "String". To monitor all variables, their type and value, please refer to the [Variable List](#)<sup>1193</sup>. See [Cue Inspector](#)<sup>204</sup>.

### ▼ VGetSeqState

```
VGetSeqState,VarName,SeqID
```

Example:

```
VGetSeqState,Counter,2
```

This applies the current playback state 'Play', 'Pause' or 'Stop' of the Sequence 1 in Pandoras Box to the variable in Widget Designer which is named "Counter". To monitor all variables, their type and value, please refer to the [Variable List](#)<sup>1193</sup>. See [Cue Inspector](#)<sup>204</sup>.

### ▼ VGetSeqTime

```
VGetSeqTime,VarName,SeqID
```

Example:

```
VGetSeqTime,Counter,1
```

This applies the timecode (e.g. 00:01:12:23) of Sequence 1 in Pandoras Box to the variable in Widget Designer which is named "Counter". The type of the variable must be "String". To monitor all variables, their type and value, please refer to the [Variable List](#)<sup>1193</sup>. See [Cue Inspector](#)<sup>204</sup>.

### ▼ SeqResetJumps

```
SeqResetJumps,SeqID,CueID
```

Example:  
SeqResetJumps,2,3

This applies to Sequence 2 in Pandoras Box. The "Repeat Count" of the Cue with ID 3 is reset to the value it was programmed with. See [Cue Inspector](#)<sup>204</sup>.

#### ▼ SeqSetTimecodeMode,....None

SeqSetTimecodeMode,SeqID,None

Example:  
SeqSetTimecodeMode,2,None

Sets the timecode mode of sequence 2 to "None", see [Sequence Inspector](#)<sup>200</sup>.

#### ▼ SeqSetTimecodeMode,....Send

SeqSetTimecodeMode,SeqID,Send

Example:  
SeqSetTimecodeMode,2,Send

Sets the timecode mode of sequence 2 to "Send".

#### ▼ SeqSetTimecodeMode,....Receive

SeqSetTimecodeMode,SeqID,Receive

Example:  
SeqSetTimecodeMode,2,Receive

Sets the timecode mode of sequence 2 to "Receive", see [Sequence Inspector](#)<sup>200</sup>.

#### ▼ SeqSetTimecodeOffset

SeqSetTimecodeOffset,SeqID,HH,MM,SS,FF

Example:  
SeqSetTimecodeOffset,2,00,05,22,12

Sets an offset of 00:05:22:12 (hh:mm:ss:ff) to the timecode of sequence 2.

#### ▼ SeqSetTimecodeOffsetF

SeqSetTimecodeOffsetF,SeqID,HH:MM:SS:FF

Example:  
SeqSetTimecodeOffsetF,2,00:05:22:12

Sets an offset of 00:05:22:12 (hh:mm:ss:ff) to the timecode of sequence 2. The timecode can also be stored and recalled using a string [variable](#)<sup>1193</sup>.

---

**▼ SeqSetTimecodeStopAction,....,Stop**

SeqSetTimecodeStopAction,SeqID,Stop

Example:

SeqSetTimecodeStopAction,1,Stop

Stops sequence 1 if the incoming timecode stops, see [Sequence Inspector](#)<sup>200</sup>.

**▼ SeqSetTimecodeStopAction,....,Pause**

SeqSetTimecodeStopAction,SeqID,Pause

Example:

SeqSetTimecodeStopAction,1,Pause

Pauses sequence 1 if the incoming timecode stops, see [Sequence Inspector](#)<sup>200</sup>.

**▼ SeqSetTimecodeStopAction,....,Continue**

SeqSetTimecodeStopAction,SeqID,Continue

Example:

SeqSetTimecodeStopAction,1,Continue

Sequence 1 will continue playing if the incoming timecode stops, see [Sequence Inspector](#)<sup>200</sup>.

**▼ SeqStoreActive**

SeqStoreActive,SeqID

Example:

SeqStoreActive,2

Stores all active parameters in Pandoras Box to sequence 2.

**▼ SeqStoreActiveToTime**

SeqStoreActiveToTime,SeqID,HH,MM,SS,FF

Example:

SeqStoreActiveToTime,2,00,05,22,12

Stores all active parameters in Pandoras Box to sequence 2 at timecode 00:05:22:12 (hh,mm,ss,ff).

**▼ SeqStoreActiveToTimeF**

SeqStoreActiveToTimeF,SeqID,HH:MM:SS:FF

Example:

SeqStoreActiveToTimeF,2,00:05:22:12

Stores all active parameters in Pandoras Box to sequence 2 at timecode 00:05:22:12 (hh,mm,ss,ff).  
The timecode can also be stored and recalled using a string [variable](#)<sup>1193</sup>.

▶ **SeqStoreActiveSite**

SeqStoreActiveSite,SeqID,SiteID

Example:

SeqStoreActiveSite,2,1

Stores all active parameters of site 1 in Pandoras Box to sequence 2 to the position of the nowpointer.

▶ **SeqStoreActiveDevice**

SeqStoreActiveDevice,SeqID,SiteID,DeviceID

Example:

SeqStoreActiveDevice,1,2,4

Stores all active parameters of layer 4 of site 2 in Pandoras Box to sequence 1 to the position of the nowpointer.

▶ **SeqStoreActiveParameter**

SeqStoreActiveParameter,SeqID,SiteID,DeviceID,Parameter

Example:

SeqStoreActiveParameter,1,2,5,Opacity

Stores all active "Opacity" parameters of layer 4 of site 2 in Pandoras Box to sequence 1 to the position of the nowpointer.

▼ **SeqContentAtTime**

SeqContentAtTime,SiteID,DevID,SeqID,HH,MM,SS,FF,FolderID,FileID

Example:

SeqContentAtTime,1,3,1,00,05,22,12,1,1

If a clip container exists at timecode 00:05:22:12 in Sequence 1, the content inside this clip container will get exchanged by the content with the Folder and File ID 1,1 and it also will be re-synced.

▼ **SeqContentAtTimeF**

SeqContentAtTimeF,SiteID,DevID,SeqID,HH:MM:SS:FF,FolderID,FileID

Example:

SeqContentAtTimeF,1,3,1,00:05:22:12,1,1

If a clip container exists at timecode 00:05:22:12 in Sequence 1, the content inside this clip container will get exchanged by the content with the Folder and File ID 1,1 and it also will be re-synced. The timecode can also be stored and recalled using a string [variable](#)<sup>1193</sup>.

### ▼ SeqContentReplaceAtTime

SeqContentReplaceAtTime,Site,Device,SeqID,HH,MM,SS,FF,FolderID,FileID

Example:

SeqContentReplaceAtTime,1,3,2,00,05,22,12,4,6

This applies to layer 3 of Site 1 (e.g. a Server) in your Pandoras Box project. The container in Sequence 2 at timecode 00:05:22:12 (hh:mm:ss:ff) is filled with the media file that holds the Folder and File ID 4,6. Please note, that this command requires an existing container whereto it can drop the media file.

### ▼ SeqContentReplaceAtTimeF

SeqContentReplaceAtTimeF,Site,Device,SeqID,HH:MM:SS:FF,FolderID,FileID

Example:

SeqContentReplaceAtTimeF,1,3,2,00:05:22:12,4,6

This applies to layer 3 of Site 1 (e.g. a Server) in your Pandoras Box project. The container in Sequence 2 at timecode 00:05:22:12 (hh:mm:ss:ff) is filled with the media file that holds the Folder and File ID 4,6. Please note, that this command requires an existing container whereto it can drop the media file.

The timecode can also be stored and recalled using a string [variable](#)<sup>1193</sup>.

### ▼ SeqContentReplaceAtTimeByPath

SeqContentReplaceAtTimeByPath,Site,Device,SeqID,HH,MM,SS,FF,ProjectPath

Example:

SeqContentReplaceAtTimeByPath,2,1,1,00,05,22,12,Testpattern/Calibrate.png

This applies to layer 3 of Site 1 (e.g. a Server) in your Pandoras Box project. The container in Sequence 2 at timecode 00:05:22:12 (hh:mm:ss:ff) is filled with the media file "Calibrate.png" from the subfolder "Testpattern" within the project folder.

If there is more than one file in the subfolder that holds this name, the first file is taken. If the file is not in a special subfolder, simply use "Calibrate.png". Please note that "ProjectPath" is case-sensitive and that this command requires an existing container whereto it can drop the media file.

### ▼ SeqContentReplaceAtTimeByPathF

SeqContentReplaceAtTimeByPathF,Site,Device,SeqID,HH:MM:SS:FF,ProjectPath

Example:

SeqContentReplaceAtTimeByPathF,2,1,1,00:05:22:12,Testpattern/Calibrate.png

This applies to layer 3 of Site 1 (e.g. a Server) in your Pandoras Box project. The container in Sequence 2 at timecode 00:05:22:12 (hh:mm:ss:ff) is filled with the media file "Calibrate.png" from the subfolder "Testpattern" within the project folder.

If there is more than one file in the subfolder that holds this name, the first file is taken. If the file is not in a special subfolder, simply use "Calibrate.png". Please note that "ProjectPath" is case-sensitive and that this command requires an existing container where to it can drop the media file. The timecode can also be stored and recalled using a string [variable](#)<sup>1193</sup>.

### ▼ SeqDeleteAllCues

SeqDeleteAllCues,SeqID

Example:  
SeqDeleteAllCues,1

All Cues in Sequence 1 will be deleted.

### ▼ SeqDeleteCue

SeqDeleteCue,SeqID,CueID

Example:  
SeqDeleteCue,1,4

Cue 4 in Sequence 1 will be deleted.

### ▼ SeqAddPlayCue

SeqAddPlayCue,SeqID,CueID,HH,MM,SS,FF,Name

Example:  
SeqAddPlayCue,1,5,00,01,22,15,Scene3

A Play Cue with the ID 5 will be added in Sequence 1 at the timecode 00:01:22:15. It will be named "Scene3".

### ▼ SeqAddPlayCueF

SeqAddPlayCueF,SeqID,CueID,HH:MM:SS:FF,Name

Example:  
SeqAddPlayCueF,1,5,00:01:22:15,Scene3

A Play Cue with the ID 5 will be added in Sequence 1 at the timecode 00:01:22:15. It will be named "Scene3".

With this command, the timecode can also be stored and recalled using a string [variable](#)<sup>1193</sup>.

### ▼ SeqAddPauseCue

SeqAddPauseCue,SeqID,CueID,HH,MM,SS,FF,Name

Example:

```
SeqAddPauseCue,1,2,00,01,22,15,Scene4
```

A Pause Cue with the ID 2 will be added in Sequence 1 at the timecode 00:01:22:15. It will be named "Scene4".

### ▼ SeqAddPauseCueF

```
SeqAddPauseCueF,SeqID,CueID,HH:MM:SS:FF,Name
```

Example:

```
SeqAddPauseCueF,1,2,00:01:22:15,Scene4
```

A Pause Cue with the ID 2 will be added in Sequence 1 at the timecode 00:01:22:15. It will be named "Scene4".

With this command, the timecode can also be stored and recalled using a string [variable](#)<sup>1193</sup>.

### ▼ SeqEdit

```
SeqEdit,ID
```

Example:

```
SeqEdit,2
```

This command toggles Sequence with ID 2 into the Sequence tab of Pandoras Box so that it is visible and editable.

### ▼ ResourceCreateText

```
ResourceCreateText,FolderID,FileID,Text
```

Example:

```
ResourceCreateText,2,10,design2
```

Creates a new text asset with the folder and file ID [2,10] in PB with the text "design2".

### ▼ ResourceSetText

```
ResourceSetText,FolderID,FileID,Text
```

Example:

```
ResourceSetText,2,9,design
```

Sets the text of text asset [2,9] in PB to "design".

### ▼ ResourceSetTextUnicode

```
ResourceSetTextUnicode,FolderID,FileID,Text
```

Example:

```
ResourceSetTextUnicode,1,2,Καλή μέρα
```

Sets the text of text asset [1,2] in PB to "Καλή μέρα".  
Using this unicode-command, text strings in any language format can be sent to PB.

### ▼ ResourceSetTextSize

ResourceSetTextSize,FolderID,FileID,Width,Height

Example:

ResourceSetTextSize,1,2,800,600

Sets the texture size of text asset [1,2] in PB to 800x600 px.  
This command is available from PB Rev. 4982 or higher.

### ▼ ResourceSetTextFullSize

ResourceSetTextFullSize,FolderID,FileID

Example:

ResourceSetTextFullSize,1,2

Removes the center-option of the text asset [1,2] in PB.  
This command is available from PB Rev. 4982 or higher.

### ▼ ResourceSetTextCentered

ResourceSetTextCentered,FolderID,FileID

Example:

ResourceSetTextCentered,1,2

Centers the text of text asset [1,2] in PB on its texture.  
This command is available from PB Rev. 4982 or higher.

### ▼ ResourceSetTextStyle

ResourceSetTextStyle,FolderID,FileID,Font,Size,Style,Alignment,Red,Green,Blue

Example:

ResourceSetTextStyle,1,2,Times New Roman,24,Bold,Left,255,0,0

Sets the Text Asset [1,2] to the following properties:

Font: Time New Roman, Font Size: 24, Font Style: Bold, Alignment: Left, Colour: Red.

This command is available from PB Rev. 4982 or higher.

Style options: Regular, Bold, Italic, BoldItalic, Underline.  
Alignment options: Left, Center, Right.

### ▼ ResourceGetTextFromLabel

ResourceGetTextFromLabel,LabelID,FolderID,FileID



Example:

```
ResourceGetTextFromLabel,3,2,9
```

Sets the text of the text asset with the Folder and File ID [2.9] in PB to the text of label 3 in WD.

#### ▼ **ResourceGetTextFromLabelUnicode**

```
ResourceGetTextFromLabelUnicode,LabelID,FolderID,FileID
```

Example:

```
ResourceGetTextFromLabelUnicode,3,2,9
```

Sets the text of the text asset with the Folder and File ID [2.9] in PB to the text of label 3 in WD. Using this Unicode-command, text strings in any language format can be sent to Pandoras Box text assets.

#### ▼ **ResourceGetTextFromTextbox**

```
ResourceGetTextFromTextbox,TextboxID,FolderID,FileID
```

Example:

```
ResourceGetTextFromTextbox,4,2,10
```

Sets the text of the text asset with the Folder and File ID [2.10] in PB to the text of textbox 4 in WD.

#### ▼ **ResourceGetTextFromTextboxUnicode**

```
ResourceGetTextFromTextboxUnicode,TextboxID,FolderID,FileID
```

Example:

```
ResourceGetTextFromTextboxUnicode,4,2,10
```

Sets the text of the text asset with the Folder and File ID [2.10] in PB to the text of textbox 4 in WD. Using this Unicode-command text strings in any language format can be sent to Pandoras Box text assets.

#### ▼ **ResourceBrowserSetURLbyID**

```
ResourceBrowserSetURLbyID,FolderID,FileID,URL
```

Example:

```
ResourceBrowserSetURLbyID,2,4,www.coolux.de
```

In PB, the Browser Asset with Folder and File ID 2,4 changes its URL to "www.coolux.de".

#### ▼ **ResourceBrowserSetURLbyName**

```
ResourceBrowserSetURLbyName,BrowserNamePath,URL
```

Example:

```
ResourceBrowserSetURLbyName,coolux.de,www.manual.coolux.de
```

In PB, the Browser Asset that is displayed with the name "coolux.de" in the Project tab, changes its URL to "www.manual.coolux.de".

### ▼ ResourceAdd

ResourceAdd,FilePath,SiteID,FolderID,FileID

Example:

```
ResourceAdd,C:\coolux\content\Video.mpg,3,4,2
```

This adds a file from a remote or local node (i.e. Client or Master) to the main folder of your Pandoras Box project.

The file "Video.mpg" is loaded from the Site with ID 3 from the path "C:\coolux\content". It is added to the project folder and assigned with Folder and File ID 4,2. If you do not need a Folder/File ID you may set it to "0,0" in the command.

### ▼ ResourceAddFileFromLocal

ResourceAddFileFromLocal,FilePath

Example:

```
ResourceAddFileFromLocal,C:\coolux\content\Image.png
```

This adds a file from your local node (i.e. the Master) to the main folder of your Pandoras Box project.

The file "Image.png" is loaded from the path "C:\coolux\content" and added to the project folder.

### ▼ ResourceAddFileFromLocalToProjectPath

ResourceAddFileFromLocalToProjectPath,FilePath,ProjectPath

Example:

```
ResourceAddFileFromLocalToProjectPath,C:\coolux\content\Image.png,background\images
```

This adds a file from your local node (i.e. the Master) to a subfolder of your Pandoras Box project.

The file "Image.png" is loaded from the path "C:\coolux\content" and added to the subfolder "images" in the subfolder "background" within the project folder. Primary/Red.png

### ▼ ResourceAddToProjectPath

ResourceAddToProjectPath,FilePath,SiteID,FolderID,FileID,ProjectPath

Example:

```
ResourceAddToProjectPath,C:\coolux\content\Video.mpg,3,4,2,background\images
```

This adds a file from a remote or local node (i.e. Client or Master) to a subfolder of your Pandoras Box project.

The file "Video.mpg" is loaded from the Site with ID 3 from the path "C:\coolux\content". It is added to the project folder and assigned with Folder and File ID 4,2. If you do not need a Folder/File ID you may set it to "0,0" in the command.

### ▼ ResourceAddFolderFromLocal

`ResourceAddFolderFromLocal,FilePath`

Example:

`ResourceAddFolderFromLocal,C:\coolux\content\testpattern`

This adds a folder from your local node (i.e. the Master) to the main folder of your Pandoras Box project.

The folder "testpattern" including all files is loaded from the path "C:\coolux\content" and added to the project folder.

### ▼ **ResourceAddFolderFromLocalToProjectPath**

`ResourceAddFolderFromLocalToProjectPath,FilePath,ProjectPath`

Example:

`ResourceAddFolderFromLocalToProjectPath,C:\coolux\content\testpattern,background\images`

This adds a folder from your local node (i.e. the Master) to a subfolder of your Pandoras Box project.

The folder "testpattern" including all files is loaded from the path "C:\coolux\content" and added to the subfolder "images" in the subfolder "background" within the project folder.

### ▼ **ResourceAddFolder**

`ResourceAddFolder,FolderName`

Example:

`ResourceAddFolder,loops`

This adds a subfolder to your Pandoras Box project.

A new subfolder named "loops" is generated.

### ▼ **ResourceAddFolderToPath**

`ResourceAddFolderToPath,FolderName,ProjectPath`

Example:

`ResourceAddFolder,loops,background\images`

This adds a subfolder to an existing subfolder in your Pandoras Box project.

A new subfolder named "loops" is generated in the subfolder "images" in the subfolder "background" within the project folder.

### ▼ **ResourceAddFolderFromLocalByID**

`ResourceAddFolderFromLocalByID,FolderPath,FolderID,FileID`

Example:

`ResourceAddFolderFromLocalByID,C:\coolux\content\testpattern,5,1`

This adds a folder from your local node (i.e. the Master) to the main folder of your Pandoras Box project and assigns Folder/File IDs.

The folder "testpattern" including all files is loaded from the path "C:\coolux\content" and added to the project folder. In addition all files are numbered consecutively with a Folder/File ID starting from 5, 1.

### ▼ ResourceAddFolderFromLocalToProjectPathByID

ResourceAddFolderFromLocalToProjectPathByID,FolderPath,ProjectPath,FolderID,FileID

Example:

```
ResourceAddFolderFromLocalToProjectPath,C:\coolux\content\testpattern,background\images,5,1
```

This adds a folder from your local node (i.e. the Master) to a subfolder of your Pandoras Box project and assigns Folder/File IDs.

The folder "testpattern" including all files is loaded from the path "C:\coolux\content" and added to the subfolder "images" in the subfolder "background" within the project folder. In addition all files are numbered consecutively with a Folder/File ID starting from 5,1.

### ▼ ResourceMove

ResourceMove,Content,ProjectPath

Example:

```
ResourceAddFolderFromLocalToProjectPath,Image.png,background\images
```

This moves the file "Image.png" that is already part of your Pandoras Box project to the subfolder "images" in the subfolder "background" within the project folder.

If there is more than one file in the project that holds this name, the first file is taken.

### ▼ ResourceRemove

ResourceRemove,Name

Example:

```
ResourceRemove,Image.png
```

This removes the file "Image.png" from your Pandoras Box project. It does not matter whether the file is in the main folder or a subfolder but if there is more than one file in the project that holds this name, the first file is deleted.

### ▼ ResourceRemoveAll

ResourceRemoveAll

Example:

```
ResourceRemoveAll
```

This removes all files from your Pandoras Box project.

In some WD versions it is necessary to declare whether folders should be deleted too. Whilst the command with an attached "true" (i.e. `ResourceRemoveAll,true`) deletes all files PLUS the folder structure the command `ResourceRemoveAll,false` deletes only single files but leaves all folders.

### ▼ ResourceDetachByPath

ResourceDetachByPath,ProjectPath,SiteID

Example:

```
ResourceDetachByPath,backgrounds\images\image1.png,3
```

This detaches a file link in your Pandoras Box project so that the specified node does not load this file anymore when the master system calls it, e.g. as an active value or from the timeline. It is now possible to attach another file that should be loaded instead. The node can be a remote or local node (i.e. Client or Master). See [Attaching Files](#)<sup>192</sup>.

In the example, the Site with ID 3 (e.g. a Server) does not load the file "image1.png" any more. The file is located in the subfolder "images" in the subfolder "background" within the project folder.

### ▼ ResourceDetachByID

```
ResourceDetachByID,FolderID,FileID,SiteID
```

Example:

```
ResourceDetachByID,2,4,3
```

This detaches a file link in your Pandoras Box project so that the specified node does not load this file anymore when the master system calls it, e.g. as an active value or from the timeline. It is now possible to attach another file that should be loaded instead. The node can be a remote or local node (i.e. Client or Master). See [Attaching Files](#)<sup>192</sup>.

In the example, the Site with ID 3 (e.g. a Server) does not load the file with Folder and File ID 2,4 any more.

### ▼ ResourceAttachByPath

```
ResourceAttachByPath,ProjectPath,SiteID,FilePath
```

Example:

```
ResourceAttachByPath,backgrounds\images\image1.png,3,C:\coolux\content\image2.png
```

This attaches a file link in your Pandoras Box project so that the specified node loads another file than the one the master system calls, e.g. as an active value or from the timeline. The node can be a remote or local node (i.e. Client or Master). See [Attaching Files](#)<sup>192</sup>.

In the example, the Site with ID 3 (e.g. a Server) loads the file "image2.png" from the path "C:\coolux\content" as soon as the master system calls the file "image1.png" that is located in the subfolder "images" in the subfolder "background" within the project folder.

### ▼ ResourceAttachByID

```
ResourceAttachByID,FolderID,FileID,SiteID,FilePath
```

Example:

```
ResourceAttachByID,2,4,3,C:\coolux\content\image2.png
```

This attaches a file link in your Pandoras Box project so that the specified node loads another file than the one the master system calls, e.g. as an active value or from the timeline. The node can be a remote or local node (i.e. Client or Master). See [Attaching Files](#)<sup>192</sup>.

In the example, the Site with ID 3 (e.g. a Server) loads the file "image2.png" from the path "C:\coolux\content" as soon as the master system calls the file with Folder and File ID 2,4.

### ▼ ResourceSetID

ResourceSetID,ProjectPath,FolderID,FileID

Example:

ResourceSetID,backgrounds\images,5,1

This applies to the subfolder "images" in the subfolder "background" within the Pandoras Box project folder. All files included in the subfolder are assigned consecutively with a Folder and File ID starting from 5, 1.

If you like to assign a Folder/File ID to a single file instead of an entire folder, specify "ProjectPath" as "backgrounds\images\image1.png".

### ▼ ResourceResize

ResourceResize,FilePath,Width,Height

Example:

ResourceResize,C:\coolux\content\image2.png,256,256

This command does not necessarily apply to a Pandoras Box project. It simply resizes an image (here: the file named "image2.png" saved under the path "C:\coolux\content") on the hard drive and saves it under the same name but with the different size. The image from the example would have a new height and width of 256 pixels. If the image is part of a Pandoras Box project it then needs to be reloaded to read-out the new size. The reload happens automatically with the default options and a Revision 9088 or higher. When using an older revision, please reload the file manually, e.g. by using the [File Inspector](#)<sup>190</sup> or reloading the project.

### ▼ ResourceSpreadAll

ResourceSpreadAll

Example:

ResourceSpreadAll

Spreads all resources in PB.

### ▼ ResourceSpreadMedia

ResourceSpreadMedia,FolderID,FileID

Example:

ResourceSpreadMedia,2,10

Spreads the media file with the Folder and File ID [2,10] in PB.

### ▼ ResourceSpreadMesh

ResourceSpreadMesh,FolderID,FileID

Example:

ResourceSpreadMesh,3,7

Spreads the mesh file with the Folder and File ID [3,7] in PB.

### ▼ ResourceSetFrameBlending

ResourceSetFrameBlending,FolderID,FileID,State(True or False)

Example:

ResourceSetFrameBlending,2,5,True

Activates frameblending for the media file with the Folder and File ID [2,5] in PB. Choose this option for slow motion or smooth motion frame-adaptive frameblending and framerate conversion, see [File Inspector](#)<sup>190</sup>.

### ▼ ResourceSetDeinterlacing

ResourceSetDeinterlacing,FolderID,FileID,State(0,1,2,3)

Example:

ResourceSetDeinterlacing,2,5,3

Activates the deinterlacing mode "fieldblending" for the media file with the Folder and File ID [2,5] in PB, see [File Inspector](#)<sup>190</sup>.

Deinterlacing Modes:

0 = Off

1 = Top Field

2 = Bottom Field

3 = Fieldblending

### ▼ ResourceSetAnisotropicFiltering

ResourceSetAnisotropicFiltering,FolderID,FileID,State(True or False)

Example:

ResourceSetAnisotropicFiltering,2,5,False

Deactivates anisotropic filtering (pixel smoothing for real-time video and image scaling) for the media file with the Folder and File ID [2,5] in PB, see [File Inspector](#)<sup>190</sup>.

### ▼ ResourceSetUnderscan

ResourceSetUnderscan,FolderID,FileID,State(True or False)

Example:

ResourceSetUnderscan,2,5,True

Enables Underscan for the media file with the Folder and File ID [2,5] in PB, see [File Inspector](#)<sup>190</sup>.

### ▼ ResourceSetMpegColourSpace

ResourceSetMpegColourSpace,FolderID,FileID,State(True or False)

Example:

ResourceSetMpegColourSpace,2,5,True

Enables the optimization of MPEG Colorspace for the media file with the Folder and File ID [2,5] in PB, see [File Inspector](#)<sup>190</sup>.

### ▼ ResourceSetAlphaChannel

ResourceSetAlphaChannel,FolderID,FileID,State(True or False)

Example:

ResourceSetAlphaChannel,2,5,False

Disables the alpha channel of the media file with the Folder and File ID [2,5] in PB.

Use "true" if movie type supports embedded alpha, see [File Inspector](#)<sup>190</sup>.

### ▼ ResourceRemoveInconsistent

ResourceRemoveInconsistent

Example:

ResourceRemoveInconsistent

Removes all inconsistent files from the master system in PB, see [Folder Inspector](#)<sup>198</sup>.

### ▼ ResourceRemoveMedia

ResourceRemoveMedia,FolderID,FileID

Example:

ResourceRemoveMedia,2,5

Removes the media file with the Folder and File ID [2,5] from the PB project, see [Project Tab](#)<sup>248</sup>.

### ▼ ResourceRemoveMesh

ResourceRemoveMesh,FolderID,FileID

Example:

ResourceRemoveMesh,3,9

Removes the mesh file with the Folder and File ID [3,9] from the PB project, see [Project Tab](#)<sup>248</sup>.

### ▼ ResourceReloadMedia

ResourceReloadMedia,FolderID,FileID

Example:

ResourceReloadMedia,2,5

Reloads the media file with the Folder and File ID [2,5] in the PB project, see [File Inspector](#)<sup>190</sup>.



### ▼ ResourceReloadMesh

ResourceReloadMesh,FolderID,FileID

Example:

ResourceReloadMesh,3,9

Reloads the mesh file with the Folder and File ID [3,9] in the PB project, see [File Inspector](#)<sup>190</sup>.

### ▼ ResourceRecordLiveInputByID

ResourceRecordLiveInputByID,FolderID,FileID,FileName,Preset,HH,MM,SS,FF

Example:

ResourceRecordLiveInputByID,2,4,C:\coolux\content\recordings\001,HD 1280x720,00,05,22,12

This records a Live Input using the Video Recording feature in the Pandoras Box project. The feature is limited to some [Pandoras Box products](#)<sup>65</sup>. See [Video Recording](#)<sup>284</sup>.

The Live Input with the Folder and File ID 2,4 is recorded and saved with the file name "001.m2v" under the path "C:\coolux\content\recordings". "HD 1280x720" is used as the Encoder Setting. The total length of the file is 00:05:22:12 (hh:mm:ss:ff). Afterwards the recorded file is added to the Pandoras Box project automatically.

### ▼ ResourceRecordLiveInputByIDF

ResourceRecordLiveInputByIDF,FolderID,FileID,FileName,Preset,HH:MM:SS:FF

Example:

ResourceRecordLiveInputByIDF,2,4,C:\coolux\content\recordings\001,HD 1280x720,00:05:22:12

This records a Live Input using the Video Recording feature in the Pandoras Box project. The feature is limited to some [Pandoras Box products](#)<sup>65</sup>. See [Video Recording](#)<sup>284</sup>.

The Live Input with the Folder and File ID 2,4 is recorded and saved with the file name "001.m2v" under the path "C:\coolux\content\recordings". "HD 1280x720" is used as the Encoder Setting. The total length of the file is 00:05:22:12 (hh:mm:ss:ff). Afterwards the recorded file is added to the Pandoras Box project automatically.

With this command the timecode can also be stored and recalled using a string [variable](#)<sup>1193</sup>.

### ▼ ResourceRecordLiveInputByIDStart

ResourceRecordLiveInputByIDStart,FolderID,FileID,FileName,Preset

Example:

ResourceRecordLiveInputByIDStart,2,4,C:\coolux\content\recordings\001,HD 1280x720,00,05,22,12

This starts to record a Live Input using the Video Recording feature in the Pandoras Box project. The feature is limited to some [Pandoras Box products](#)<sup>65</sup>. See [Video Recording](#)<sup>284</sup>.

The Live Input with the Folder and File ID 2,4 is recorded and saved with the file name "001.m2v" under the path "C:\coolux\content\recordings". "HD 1280x720" is used as the Encoder Setting. The total length of the file depends on when the recording is stopped again. Afterwards the recorded file is added to the Pandoras Box project automatically.

### ▼ ResourceRecordLiveInputStop

ResourceRecordLiveInputStop

Example:

ResourceRecordLiveInputStop

This stops to record a Live Input using the Video Recording feature in the Pandoras Box project. See above.

### ▼ ResourceRecordLiveInput

ResourceRecordLiveInput,InputName,FileName,Preset,HH,MM,SS,FF

Example:

ResourceRecordLiveInput,Integrated Webcam-2,C:\coolux\content\recordings\001,HD  
1280x720,00,05,22,12

This records a Live Input using the Video Recording feature in the Pandoras Box project. The feature is limited to some [Pandoras Box products](#)<sup>[65]</sup>. See [Video Recording](#)<sup>[284]</sup>.

The Live Input with the name "Integrated Webcam-2" is recorded and saved with the file name "001.m2v" under the path "C:\coolux\content\recordings". "HD 1280x720" is used as the Encoder Setting. The total length of the file is 00:05:22:12 (hh:mm:ss:ff). Afterwards the recorded file is added to the Pandoras Box project automatically.

### ▼ ResourceRecordLiveInputF

ResourceRecordLiveInputF,InputName,FileName,Preset,HH:MM:SS:FF

Example:

ResourceRecordLiveInputF,Integrated Webcam-2,C:\coolux\content\recordings\001,HD  
1280x720,00:05:22:12

This records a Live Input using the Video Recording feature in the Pandoras Box project. The feature is limited to some [Pandoras Box products](#)<sup>[65]</sup>. See [Video Recording](#)<sup>[284]</sup>.

The Live Input with the name "Integrated Webcam-2" is recorded and saved with the file name "001.m2v" under the path "C:\coolux\content\recordings". "HD 1280x720" is used as the Encoder Setting. The total length of the file is 00:05:22:12 (hh:mm:ss:ff). Afterwards the recorded file is added to the Pandoras Box project automatically.

With this command the timecode can also be stored and recalled using a string [variable](#)<sup>[1193]</sup>.

### ▼ ResourceRecordLiveInputStart

ResourceRecordLiveInputStart,InputName,FileName,Preset

Example:

ResourceRecordLiveInput,Integrated Webcam-2,C:\coolux\content\recordings\001,HD  
1280x720,00,05,22,12

This starts to record a Live Input using the Video Recording feature in the Pandoras Box project. The feature is limited to some [Pandoras Box products](#)<sup>[65]</sup>. See [Video Recording](#)<sup>[284]</sup>.

The Live Input with the name "Integrated Webcam-2" is recorded and saved with the file name "001.m2v" under the path "C:\coolux\content\recordings". "HD 1280x720" is used as the Encoder Setting. The total length of the file depends on when the recording is stopped again. Afterwards the recorded file is added to the Pandoras Box project automatically.

### ▼ ResourceExportSeq

ResourceExportSeq,SeqID,FileName,Preset,StartHH,MM,SS,FF,StopHH,MM,SS,FF

Example:

ResourceExportSeq,2,C:\coolux\content\export\001,HD 1280x720,00,05,22,12,00,15,23,13

This records what you have programmed on a sequence using the Video Export feature in the Pandoras Box project. The feature is limited to some [Pandoras Box products](#)<sup>[65]</sup>. See [Video Export](#)<sup>[281]</sup>.

The Sequence with ID 2 is recorded and saved with the file name "001.m2v" under the path "C:\coolux\content\export". "HD 1280x720" is used as the Encoder Setting. The recording starts at 00:05:22:12 and ends at 00:15:23:13 (hh:mm:ss:ff). Afterwards the recorded file is added to the Pandoras Box project automatically.

### ▼ ResourceExportSeqF

ResourceExportSeqF,SeqID,FileName,Preset,StartHH:MM:SS:FF,StopHH:MM:SS:FF

Example:

ResourceExportSeqF,2,C:\coolux\content\export\001,HD 1280x720,00:05:22:12,00:15:23:13

This records what you have programmed on a sequence using the Video Export feature in the Pandoras Box project. The feature is limited to some [Pandoras Box products](#)<sup>[65]</sup>. See [Video Export](#)<sup>[281]</sup>.

The Sequence with ID 2 is recorded and saved with the file name "001.m2v" under the path "C:\coolux\content\export". "HD 1280x720" is used as the Encoder Setting. The recording starts at 00:05:22:12 and ends at 00:15:23:13 (hh:mm:ss:ff). Afterwards the recorded file is added to the Pandoras Box project automatically.

With this command both timecodes can also be stored and recalled using string [variables](#)<sup>[1193]</sup>.

### ▼ ResourceCanvasClearByID

ResourceCanvasClearByID,FolderID,FileID

Example:

ResourceCanvasClearByID,2,4

This clears the Canvas Asset in your Pandoras Box project so that it is empty. See [Project tab > Media Files](#)<sup>[248]</sup>.

### ▼ ResourceCreatePBPlaylistByID

ResourceCreatePBPlaylistByID,FolderID,FileID

Example:

ResourceCreatePBPlaylistByID,1,2

This creates a new empty [Pandoras Box playlist](#)<sup>[229]</sup> and assigns the folder and file ID [1,2].

### ▼ ResourceCreatePBPlaylistByPath

ResourceCreatePBPlaylistByPath,ProjectPath

Example:

ResourceCreatePBPlaylistByPath,Playlist Test\First

This creates a new empty [Pandoras Box playlist](#)<sup>[229]</sup> and adds it to the subfolder “First” in the subfolder “Playlist Test” within the project folder.

### ▼ ResourceCreatePBPlaylistByPathWithID

ResourceCreatePBPlaylistByPathWithID,ProjectPath,FolderID,FileID

Example:

ResourceCreatePBPlaylistByPathWithID,Playlist Test\Second,4,8

This creates a new empty [Pandoras Box playlist](#)<sup>[229]</sup>. It is added to the subfolder “Second” in the subfolder “Playlist Test” within the project folder and then assigned with the folder and file ID [4,8].

### ▼ ResourceCreatePBPlaylistFromFolderByPath

ResourceCreatePBPlaylistFromFolderByPath,PlaylistPath,SourceFolderPath

Example:

ResourceCreatePBPlaylistFromFolderByPath,Playlist Test\First,Content\Medialoops

This creates a new [Pandoras Box playlist](#)<sup>[229]</sup> and adds it to the subfolder “First” in the subfolder “Playlist Test” within the project folder. The content from “Content\Medialoops” will be added to the playlist.

### ▼ ResourceCreatePBPlaylistFromFolderByPathWithID

ResourceCreatePBPlaylistFromFolderByPathWithID,PlaylistPath,SourceFolderPath,FolderID,FileID

Example:

ResourceCreatePBPlaylistFromFolderByPathWithID,Playlist Test\First,Content\Medialoops,3,5

This creates a new [Pandoras Box playlist](#)<sup>[229]</sup> and adds it to the subfolder “First” in the subfolder “Playlist Test” within the project folder. The content from “Content\Medialoops” will be added to the playlist and the folder and file ID [3,5] is assigned.

### ▼ ResourcePBPlaylistRemoveAllItemByID

ResourcePBPlaylistRemoveAllItemByID,FolderID,FileID

Example:

ResourcePBPlaylistRemoveAllItemByID,1,9

This removes the content from the [Pandoras Box playlist](#)<sup>[229]</sup> with the folder and file ID [1,9].

### ▼ ResourcePBPlaylistRemoveAllItemByPath

ResourcePBPlaylistRemoveAllItemByPath,PlaylistPath

Example:

ResourcePBPlaylistRemoveAllItemByPath,Playlist Test\Playlist 1

This removes the content from the [Pandoras Box playlist](#)<sup>[229]</sup> “Playlist 1” of the subfolder “Playlist Test” within the project folder.

### ▼ ResourcePBPlaylistRemoveItemByID

ResourcePBPlaylistRemoveItemByID,FolderID,FileID,RemoveID

Example:

ResourcePBPlaylistRemoveItemByID,1,9,5

This removes the item with index number 5 from the [Pandoras Box playlist](#)<sup>[229]</sup> with the folder and file ID [1,9]. All following items decrease their indices by one, e.g. item number 6 becomes item number 5.

### ▼ ResourcePBPlaylistRemoveItemByPath

ResourcePBPlaylistRemoveItemByPath,PlaylistPath,RemoveID

Example:

ResourcePBPlaylistRemoveItemByPath,Playlist Test\Playlist 1,5

This removes the item with index number 5 from the [Pandoras Box playlist](#)<sup>[229]</sup> “Playlist 1” of the subfolder “Playlist Test” within the project folder. All following items decrease their indices by one, e.g. item number 6 becomes item number 5.

### ▼ ResourcePBPlaylistInsertItemByID

ResourcePBPlaylistInsertItemByID,PlaylistFolderID,PlaylistFileID,ItemFolderID,ItemFileID,Index

Example:

ResourcePBPlaylistInsertItemByID,4,5,1,8,3

This inserts the media file with the folder and file ID [1,8] to the [Pandoras Box playlist](#)<sup>[229]</sup> with the folder and file ID [4,5] as index 3. All following items increase their indices by one, e.g. the former item number 3 becomes item number 4.

### ▼ ResourcePBPlaylistInsertItemByPath

ResourcePBPlaylistInsertItemByPath,PlaylistPath,ItemPath,Index

Example:

ResourcePBPlaylistInsertItemByPath,Playlist Test\Playlist 1,Gradients\Calibrate.png,3

This inserts the media file "Calibrate.png" to the [Pandoras Box playlist](#)<sup>229</sup> "Playlist 1" of the subfolder "Playlist Test" within the project folder. The new media is assigned with index 3. All following items increase their indices by one, e.g. the item number 3 becomes item number 4.

#### ▼ ResourcePBPlaylistAddItemByID

ResourcePBPlaylistAddItemByID,PlaylistFolderID,PlaylistFileID,ItemFolderID,ItemFileID

Example:

ResourcePBPlaylistAddItemByID,4,5,1,8

This adds the media file with the folder and file ID [1,8] to the end of the [Pandoras Box playlist](#)<sup>229</sup> with the folder and file ID [4,5].

#### ▼ ResourcePBPlaylistAddItemByPath

ResourcePBPlaylistAddItemByPath,PlaylistPath,ItemPath

Example:

ResourcePBPlaylistAddItemByPath,Playlist Test\Playlist 1,Gradients\Calibrate.png

This adds the media file "Calibrate.png" to the end of the [Pandoras Box playlist](#)<sup>229</sup> "Playlist 1" of the subfolder "Playlist Test" within the project folder,

#### ▼ ResourcePBPlaylistSetItemIndexByID

ResourcePBPlaylistSetItemIndexByID,PlaylistFolderID,PlaylistFileID,OldIndex,NewIndex

Example:

ResourcePBPlaylistSetItemIndexByID,2,1,7,4

This sets the item with index 7 to index 4 of the [Pandoras Box playlist](#)<sup>229</sup> with the folder and file ID [2,1]. All original items 4-6 increase their indices by one, e.g. the item of index 4 moves forward to index 5.

#### ▼ ResourcePBPlaylistSetItemIndexByPath

ResourcePBPlaylistSetItemIndexByPath,PlaylistPath,OldIndex,NewIndex

Example:

ResourcePBPlaylistSetItemIndexByID,Playlist Test\Playlist 1,7,4

This sets the item with index 7 to index 4 of the [Pandoras Box playlist](#)<sup>229</sup> "Playlist 1" of the subfolder "Playlist Test" within the project folder. All original items 4-6 increase their indices by one, e.g. the item of index 4 moves forward to index 5.

#### ▼ ResourcePBPlaylistSetItemDurationByID

ResourcePBPlaylistSetItemDurationByID,PlaylistFolderID,PlaylistFileID,Index,HH,MM,SS,FF

Example:

```
ResourcePBPlaylistSetItemDurationByID,2,1,8,00,05,22,12
```

This sets the duration of the item with index 8 of the [Pandoras Box playlist](#)<sup>229</sup> with the folder and file ID [2,1] to 00:05:22:12 (hh:mm:ss:ff).

#### ▼ ResourcePBPlaylistSetItemDurationByIDF

```
ResourcePBPlaylistSetItemDurationByIDF,PlaylistFolderID,PlaylistFileID,Index,HH:MM:SS:FF
```

Example:

```
ResourcePBPlaylistSetItemDurationByIDF,2,1,8,00:05:22:12
```

This sets the duration of the item with index 8 of the Pandoras Box playlist with the folder and file ID [2,1] to 00:05:22:12 (hh:mm:ss:ff). With this command, the timecode can also be stored and recalled using a [string variable](#)<sup>1193</sup>.

#### ▼ ResourcePBPlaylistSetItemDurationByPath

```
ResourcePBPlaylistSetItemDurationByPath,PlaylistPath,Index,HH,MM,SS,FF
```

Example:

```
ResourcePBPlaylistSetItemDurationByPath,Playlist Test\Playlist 1,8,00,05,22,12
```

This sets the duration of the item with index 8 of the [Pandoras Box playlist](#)<sup>229</sup> “Playlist 1” of the subfolder “Playlist Test” within the project folder to 00:05:22:12 (hh:mm:ss:ff).

#### ▼ ResourcePBPlaylistSetItemDurationByPathF

```
ResourcePBPlaylistSetItemDurationByPathF,PlaylistPath,Index,HH:MM:SS:FF
```

Example:

```
ResourcePBPlaylistSetItemDurationByPathF,Playlist Test\Playlist 1,8,00:05:22:12
```

This sets the duration of the item with index 8 of the [Pandoras Box playlist](#)<sup>229</sup> “Playlist 1” of the subfolder “Playlist Test” within the project folder to 00:05:22:12 (hh:mm:ss:ff). With this command, the timecode can also be stored and recalled using a [string variable](#)<sup>1193</sup>.

#### ▼ ResourcePBPlaylistSetItemFadeOutByID

```
ResourcePBPlaylistSetItemFadeOutByID,PlaylistFolderID,PlaylistFileID,Index,HH,MM,SS,FF
```

Example:

```
ResourcePBPlaylistSetItemFadeOutByID,2,1,8,00,05,22,12
```

This sets the fade out time of the item with index 8 of the [Pandoras Box playlist](#)<sup>229</sup> with the folder and file ID [2,1] to 00:05:22:12 (hh:mm:ss:ff).

#### ▼ ResourcePBPlaylistSetItemFadeOutByIDF

```
ResourcePBPlaylistSetItemFadeOutByIDF,PlaylistFolderID,PlaylistFileID,Index,HH:MM:SS:FF
```

Example:

```
ResourcePBPlaylistSetItemFadeOutByIDF,2,1,8,00:05:22:12
```

This sets the fade out time of the item with index 8 of the [Pandoras Box playlist](#)<sup>229</sup> with the folder and file ID [2,1] to 00:05:22:12 (hh:mm:ss:ff). With this command, the timecode can also be stored and recalled using a [string variable](#)<sup>1193</sup>.

#### ▼ ResourcePBPlaylistSetItemFadeOutByPath

```
ResourcePBPlaylistSetItemFadeOutByPath,PlaylistPath,Index,HH,MM,SS,FF
```

Example:

```
ResourcePBPlaylistSetItemFadeOutByPath,Playlist Test\Playlist 1,8,00,05,22,12
```

This sets the fade out time of the item with index 8 of the [Pandoras Box playlist](#)<sup>229</sup> “Playlist 1” of the subfolder “Playlist Test” within the project folder to 00:05:22:12 (hh:mm:ss:ff).

#### ▼ ResourcePBPlaylistSetItemFadeOutByPathF

```
ResourcePBPlaylistSetItemFadeOutByPathF,PlaylistPath,Index,HH:MM:SS:FF
```

Example:

```
ResourcePBPlaylistSetItemFadeOutByPathF,Playlist Test\Playlist 1,8,00:05:22:12
```

This sets the fade out time of the item with index 8 of the [Pandoras Box playlist](#)<sup>229</sup> “Playlist 1” of the subfolder “Playlist Test” within the project folder to 00:05:22:12 (hh:mm:ss:ff). With this command, the timecode can also be stored and recalled using a [string variable](#)<sup>1193</sup>.

#### ▼ ResourcePBPlaylistSetItemInPointByID

```
ResourcePBPlaylistSetItemInPointByID,PlaylistFolderID,PlaylistFileID,Index,HH,MM,SS,FF
```

Example:

```
ResourcePBPlaylistSetItemInPointByID,2,1,8,00,05,22,12
```

This sets the inpoint time of the item with index 8 of the [Pandoras Box playlist](#)<sup>229</sup> with the folder and file ID [2,1] to 00:05:22:12 (hh:mm:ss:ff).

#### ▼ ResourcePBPlaylistSetItemInPointByIDF

```
ResourcePBPlaylistSetItemInPointByIDF,PlaylistFolderID,PlaylistFileID,Index,HH:MM:SS:FF
```

Example:

```
ResourcePBPlaylistSetItemInPointByIDF,2,1,8,00:05:22:12
```

This sets the inpoint time of the item with index 8 of the [Pandoras Box playlist](#)<sup>229</sup> with the folder and file ID [2,1] to 00:05:22:12 (hh:mm:ss:ff). With this command, the timecode can also be stored and recalled using a [string variable](#)<sup>1193</sup>.



### ▼ ResourcePBPlaylistSetItemInPointByPath

ResourcePBPlaylistSetItemInPointByPath,PlaylistPath,Index,HH,MM,SS,FF

Example:

ResourcePBPlaylistSetItemFadeOutByPath,Playlist Test\Playlist 1,8,00,05,22,12

This sets the inpoint time of the item with index 8 of the [Pandoras Box playlist](#)<sup>229</sup> “Playlist 1” of the subfolder “Playlist Test” within the project folder to 00:05:22:12 (hh:mm:ss:ff).

### ▼ ResourcePBPlaylistSetItemInPointByPathF

ResourcePBPlaylistSetItemInPointByPathF,PlaylistPath,Index,HH:MM:SS:FF

Example:

ResourcePBPlaylistSetItemInPointByPathF,Playlist Test\Playlist 1,8,00:05:22:12

This sets the inpoint time of the item with index 8 of the [Pandoras Box playlist](#)<sup>229</sup> “Playlist 1” of the subfolder “Playlist Test” within the project folder to 00:05:22:12 (hh:mm:ss:ff). With this command, the timecode can also be stored and recalled using a [string variable](#)<sup>1193</sup>.

### ▼ ResourcePBPlaylistSetItemOutPointByID

ResourcePBPlaylistSetItemOutPointByID,PlaylistFolderID,PlaylistFileID,Index,HH,MM,SS,FF

Example:

ResourcePBPlaylistSetItemOutPointByID,2,1,8,00,05,22,12

This sets the outpoint time of the item with index 8 of the [Pandoras Box playlist](#)<sup>229</sup> with the folder and file ID [2,1] to 00:05:22:12 (hh:mm:ss:ff).

### ▼ ResourcePBPlaylistSetItemOutPointByIDF

ResourcePBPlaylistSetItemOutPointByIDF,PlaylistFolderID,PlaylistFileID,Index,HH:MM:SS:FF

Example:

ResourcePBPlaylistSetItemOutPointByIDF,2,1,8,00:05:22:12

This sets the outpoint time of the item with index 8 of the [Pandoras Box playlist](#)<sup>229</sup> with the folder and file ID [2,1] to 00:05:22:12 (hh:mm:ss:ff). With this command, the timecode can also be stored and recalled using a [string variable](#)<sup>1193</sup>.

### ▼ ResourcePBPlaylistSetItemOutPointByPath

ResourcePBPlaylistSetItemOutPointByPath,PlaylistPath,Index,HH,MM,SS,FF

Example:

ResourcePBPlaylistSetItemOutPointByPath,Playlist Test\Playlist 1,8,00,05,22,12

This sets the outpoint time of the item with index 8 of the [Pandoras Box playlist](#)<sup>229</sup> “Playlist 1” of the subfolder “Playlist Test” within the project folder to 00:05:22:12 (hh:mm:ss:ff).

### ▼ ResourcePBPlaylistSetItemOutPointByPathF

ResourcePBPlaylistSetItemOutPointByPathF,PlaylistPath,Index,HH:MM:SS:FF

Example:

ResourcePBPlaylistSetItemOutPointByPathF,Playlist Test\Playlist 1,8,00:05:22:12

This sets the outpoint time of the item with index 8 of the [Pandoras Box playlist](#)<sup>229</sup> "Playlist 1" of the subfolder "Playlist Test" within the project folder to 00:05:22:12 (hh:mm:ss:ff). With this command, the timecode can also be stored and recalled using a [string variable](#)<sup>1193</sup>.

### ▼ ResourcePBPlaylistSetItemTransitionFXByID

ResourcePBPlaylistSetItemTransitionFXByID,PlaylistFolderID,PlaylistFileID,Index,FXID

Example:

ResourcePBPlaylistSetItemTransitionFXByID,2,1,8,1

This sets the Transition FX of the item with index 8 of the [Pandoras Box playlist](#)<sup>229</sup> with the folder and file ID [2,1] to "TransitionFX 001". If you like to change it back to the default "Crossfade", use 0.

### ▼ ResourcePBPlaylistSetItemTransitionFXByPath

ResourcePBPlaylistSetItemTransitionFXByPath,PlaylistPath,Index,FXID

Example:

ResourcePBPlaylistSetItemTransitionFXByPath,Playlist Test\Playlist 1,8,1

This sets the Transition FX of the item with index 8 of the [Pandoras Box playlist](#)<sup>229</sup> "Playlist 1" of the subfolder "Playlist Test" within the project folder to "TransitionFX 001". If you like to change it back to the default "Crossfade", use 0.

### ▼ VGetPBPlaylistItemCountByID

VGetPBPlaylistItemCountByID,VarName,PlaylistFolderID,PlaylistFileID

Example:

VGetPBPlaylistItemCountByID,var1,2,1

This returns the total count of items of the [Pandoras Box playlist](#)<sup>229</sup> with the folder and file ID [2,1]. The (string or number) [Variable](#)<sup>1193</sup> "var1" in Widget Designer will be assigned with this number.

### ▼ VGetPBPlaylistItemCountByPath

VGetPBPlaylistItemCountByPath,VarName,PlaylistPath

Example:

VGetPBPlaylistItemCountByPath,var1,Playlist Test\Playlist 1

This returns the total count of items of the [Pandoras Box playlist](#)<sup>229</sup> "Playlist 1" of the subfolder "Playlist Test" within the project folder. The (string or number) [Variable](#)<sup>1193</sup> "var1" in Widget Designer will be assigned with this number.

### ▼ AddFileToPBPlaylistByID

AddFileToPBPlaylistByID,FileName,ProjectFolder,TempFolderID,TempFileID,PbPlaylistFolderID,PbPlaylistFileID

Example:

AddFileToPBPlaylistByID,C:\coolux\content\playlist\image5.png,playlist,2,5,3,6

First, the file "image5.png" from the path "C:\coolux\content\playlist" is loaded and added to the subfolder "playlist" within your Pandoras Box project. Secondly, the file is assigned with the Folder and File ID 2,5. Last, this file is added to the Playlist with Folder/File ID 3,6. See [Playlist](#)<sup>229</sup>. If you do not need a Folder/File ID in the second step, simply use "0,0" instead of "2,5".

### ▼ SetPBPlaylistItemDurationByID

SetPBPlaylistItemDurationByID,Folder,File,ItemID,HH,MM,SS,FF

Example:

SetPBPlaylistItemDurationByID,2,1,8,00,05,22,12

This sets the duration of the item with index 7(!) of the [Pandoras Box playlist](#)<sup>229</sup> with the folder and file ID [2,1] to 00:05:22:12 (hh:mm:ss:ff). Note that ItemID 0 refers to the PB index 1!

### ▼ SetPBPlaylistItemDurationByIDF

SetPBPlaylistItemDurationByIDF,Folder,File,ItemID,HH:MM:SS:FF

Example:

SetPBPlaylistItemDurationByIDF,2,1,8,00:05:22:12

This sets the duration of the item with index 7(!) of the [Pandoras Box playlist](#)<sup>229</sup> with the folder and file ID [2,1] to 00:05:22:12 (hh:mm:ss:ff). Note that ItemID 0 refers to the PB index 1! With this command, the timecode can also be stored and recalled using a [string variable](#)<sup>1193</sup>.

### ▼ SetPBPlaylistAllItemDurationByID

SetPBPlaylistAllItemDurationByID,Folder,File,HH,MM,SS,FF

Example:

SetPBPlaylistAllItemDurationByID,2,1,00,05,22,12

This sets the duration of all items of the [Pandoras Box playlist](#)<sup>229</sup> with the folder and file ID [2,1] to 00:05:22:12 (hh:mm:ss:ff).

### ▼ SetPBPlaylistAllItemDurationByIDF

SetPBPlaylistAllItemDurationByIDF,Folder,File,HH:MM:SS:FF

Example:

SetPBPlaylistAllItemDurationByIDF,2,1,00:05:22:12

This sets the duration of all items of the [Pandoras Box playlist](#)<sup>229</sup> with the folder and file ID [2,1] to 00:05:22:12 (hh:mm:ss:ff). With this command, the timecode can also be stored and recalled using a [string variable](#)<sup>1193</sup>.

### ▼ AddEncryptionKey

AddEncryptionKey,Key

Example:

```
AddEncryptionKey,Key1|uYxJLvsAK+ZAJpLQgpSf1u6wwaA5e0UurBJq2
+MTsugQpLiXSOHRCAHdcMBVf2GSfZLRn5UoURJlfnmpJOF78d33pFdTfdKdj6YjnJEr0=
```

This applies to the [Media Encryption feature](#)<sup>218</sup> in Pandoras Box. Using this command you can import a key that was exported earlier with another PB project.

### ▼ AddEncryptionPolicy

AddEncryptionPolicy,Policy

Example:

```
AddEncryptionPolicy,Pol1|Y3dm4ld4S7XB0NzYLinuseF7jXzUexhTBWSysoPIXZKUmgnbuWfG/t39j
+qxUE5FdDSaoZpOzbQUuje0E13FeKfMHKbfFpvS5FATyI8LvJ=
```

This applies to the [Media Encryption feature](#)<sup>218</sup> in Pandoras Box. Using this command you can import a policy that was exported earlier with another PB project.

### ▼ ToggleFullScreen

ToggleFullScreen,SiteID

Example:

```
ToggleFullScreen,4
```

Switches the site 4 from windowed to fullscreen mode in Pandoras Box project, see [Device Tree Context\\_Menus](#)<sup>172</sup>.

### ▼ FullScreenByID

FullScreenByID,SiteID

Example:

```
FullScreenByID,4
```

Switches the site 4 to fullscreen mode in Pandoras Box project whether it is in windowed mode or in fullscreen mode already, see [Device Tree Context\\_Menus](#)<sup>172</sup>.

### ▼ WindowedModeByID

WindowedModeByID,SiteID

Example:  
WindowedModeByID,4

Switches the site 4 to windowed mode in Pandoras Box project whether it is in fullscreen mode or in windowed mode already, see [Device Tree Context\\_Menus](#)<sup>[172]</sup>.

#### ▼ **PBLoadProject,,,,,SaveCurrent**

PBLoadProject,Path,Name,SaveCurrent

Example:  
PBLoadProject,C:\coolux\Projects\Rotation.xml,SaveCurrent

Saves the current PB project and opens the project "Rotation.xml" from the specified directory.

#### ▼ **PBLoadProject,,,,,DoNotSaveCurrent**

PBLoadProject,Path,Name,DoNotSaveCurrent

Example:  
PBLoadProject,C:\coolux\Projects,Rotation.xml,DoNotSaveCurrent

Opens the PB project "Rotation.xml" from the specified directory without saving the current project.

#### ▼ **PBSaveProject**

PBSaveProject

Example:  
PBSaveProject

Saves the current project of the PB master device that is connected to the Widget Designer.

#### ▼ **PBCloseProject,SaveCurrent**

PBCloseProject,SaveCurrent

Example:  
PBCloseProject,SaveCurrent

Closes the current project in PB after saving it.

#### ▼ **PBCloseProject,DoNotSaveCurrent**

PBCloseProject,DoNotSaveCurrent

Example:  
PBCloseProject,DoNotSaveCurrent

Closes the current project in PB without saving it.

### ▼ **PBFaderMap**

PBFaderMap,FaderID,SeqID

Example:  
PBFaderMap,3,1

Links Fader 3 of the PB Fader Board to the sequence 1 in Pandoras Box Master System.

### ▼ **PBCueMap**

PBFaderMap,ButtonID,SeqID,CueID

Example:  
PBCueMap,2,1,10

Links Button 2 of the PB Jog Shuttle Board to Cue 10 of sequence 1 in Pandoras Box Master System.

### ▼ **DeviceAcceptDmxById,....,On**

DeviceAcceptDmxById,SiteID,DeviceID,On

Example:  
DeviceAcceptDmxById,2,1,On

Enables Layer 2 of Site 1 to be included for DMX / Art-Net Input, see [Patch Tab](#)<sup>222</sup>.

Please note:  
Art-Net Input needs to be enabled in [Configuration Tab](#)<sup>139</sup> in order to remote control the Layer via Art-Net.

To change the Devices DMX / Art-Net start address (Channel, Art-Net Subnet and Universe) use either the Patch Tab in PB or the WD command [DeviceSetDmxAddress](#)<sup>1303</sup>.

### ▼ **DeviceAcceptDmxById,....,Off**

DeviceAcceptDmxById,SiteID,DeviceID,Off

Example:  
DeviceAcceptDmxById,2,1,Off

Disables Layer 2 of Site 1 from being included for DMX / Art-Net Input, see [Patch Tab](#)<sup>222</sup>. It cannot be controlled via an attached DMX device / Art-Net anymore.

### ▼ **SiteAcceptDmxById,....,On**

SiteAcceptDmxById,SiteID,On

Example:  
SiteAcceptDmxById,2,On

Enables the Site 2 to be included for DMX / Art-Net Input, see [Patch Tab](#)<sup>222</sup>.

Please note:

Art-Net Input needs to be enabled in [Configuration Tab](#)<sup>139</sup> in order to remote control the Site via Art-Net.

To change the Devices DMX / Art-Net start address (Channel, Art-Net Subnet and Universe) use either the Patch Tab in PB or the WD command [DeviceSetDmxAddress](#)<sup>1303</sup>.

### ▼ **SiteAcceptDmxByld,....,Off**

SiteAcceptDmxByld,SiteID,Off

Example:

SiteAcceptDmxByld,2,Off

Disables Site 2 from being included for DMX / Art-Net Input, see [Patch Tab](#)<sup>222</sup>. It cannot be controlled via an attached DMX device / Art-Net anymore.

### ▼ **DeviceSetDmxAddress**

DeviceSetDmxAddress,SiteID,DeviceID,DMXStart,Universe,Subnet

Example:

DeviceSetDmxAddress,2,1,0,5,4

Patches layer [2,1] in PB to the DMX start address 1, Art net Universe 5 and Subnet ID 4.

### ▼ **DeviceSetIp**

DeviceSetIp,SiteID,IP Address

Example:

DeviceSetIp,3,2.0.0.103

Sets the IP of Site 3 inside your PB project to 2.0.0.103.

Please note:

This command is only working from PB version 5237 on.

### ▼ **WakeOnLan**

WakeOnLan,MacAddress

Example:

WakeOnLan,00-14-f5-0d-37-29

Turns on or wakes up the computer with the MacAddress 08-00-20-ae-fd-7e.

Please note:

Precondition for using WakeOnLan is that the ethernet adapter of the computer you want to wake up supports WakeOnLan with Magic Packet. Please confirm these settings in the ethernet cards properties in the computers device manager.

---

### ▼ **PBShutDown**

PBShutDown,IP address

Example:

PBShutDown,10.169.10.65

Turns off the PB computer with the IP address 10.169.10.65 in the local network.

Please note:

All PB commands will only work when the Onscreen Menu up from Rev. 34 is installed on the computers!

### ▼ **PBShutDownAll**

PBShutDownAll

Example:

PBShutDownAll

Shuts down all PB computers in the local network.

Please note:

All PB commands will only work when the Onscreen Menu up from Rev. 34 is installed on the computers!

### ▼ **PBReboot**

PBReboot,IP address

Example:

PBReboot,10.169.10.65

Reboots the PB computer with the IP address 10.169.10.65 in the local network.

Please note:

All PB commands will only work when the Onscreen Menu up from Rev. 34 is installed on the computers!

### ▼ **PBRebootAll**

PBRebootAll

Example:

PBRebootAll

Reboots all PB computers in the local network.

Please note:

All PB commands will only work when the Onscreen Menu up from Rev. 34 is installed on the computers!



---

### ▼ **PBStartMaster**

PBStartMaster,IP address

Example:

PBStartMaster,10.169.10.65

Launches the PB Master software on the computer with the IP address 10.169.10.65 in the local network.

Please note:

All PB commands will only work when the Onscreen Menu up from Rev. 34 is installed on the computers!

### ▼ **PBStartMasterAll**

PBStartMasterAll

Example:

PBStartMasterAll

Launches the PB Master software on all computers in the local network.

Please note:

All PB commands will only work when the Onscreen Menu up from Rev. 34 is installed on the computers!

### ▼ **PBStartClient**

PBStartClient,IP address

Example:

PBStartClient,10.169.10.65

Launches the PB Client software on the computer with the IP address 10.169.10.65 in the local network.

Please note:

All PB commands will only work when the Onscreen Menu up from Rev. 34 is installed on the computers!

### ▼ **PBStartClientAll**

PBStartClientAll

Example:

PBStartClientAll

Launches the PB Client software on all computers in the local network.

Please note:

All PB commands will only work when the Onscreen Menu up from Rev. 34 is installed on the computers!

---

### ▼ **PBClose**

PBClose,IP address

Example:

PBClose,10.169.10.65

Closes the PB software on the computer with the IP address 10.169.10.65 in the local network.

Please note:

All PB commands will only work when the Onscreen Menu up from Rev. 34 is installed on the computers!

### ▼ **PBCloseAll**

PBCloseAll

Example:

PBCloseAll

Closes the PB software on all computers in the local network.

Please note:

All PB commands will only work when the Onscreen Menu up from Rev. 34 is installed on the computers!

### ▼ **PBSetOutput1ResolutionAll**

PBSetOutput1ResolutionAll,1024 768 60

Example:

PBSetOutput1ResolutionAll,1024 768 60

Sets the resolution of output 1 of all PB computers in the local network to 1024x786 px @ 60 Hz.

Please note:

All PB commands will only work when the Onscreen Menu up from Rev. 34 is installed on the computers!

### ▼ **PBSetOutput2ResolutionAll**

PBSetOutput2ResolutionAll,1024 768 60

Example:

PBSetOutput2ResolutionAll,1024 768 60

Sets the resolution of output 2 of all PB computers in the local network to 1024x786 px @ 60 Hz.

Please note:

All PB commands will only work when the Onscreen Menu up from Rev. 34 is installed on the computers!

### ▼ **PBDeactivateOutput2All**

PBDeactivateOutput2All

Example:

PBDeactivateOutput2All

Deactivates output 2 of all PB computers in the local network.

Please note:

All PB commands will only work when the Onscreen Menu up from Rev. 34 is installed on the computers!

### ▼ **PBSetOutput1Resolution**

PBSetOutput1Resolution,IP address,1024 768 60

Example:

PBSetOutput1Resolution,10.169.10.65,1920 1080 60

Sets the resolution of output 1 of the PB computer with the IP address 10.169.10.65 to 1920x1080 px and 60 Hz.

Please note:

All PB commands will only work when the Onscreen Menu up from Rev. 34 is installed on the computers!

### ▼ **PBSetOutput2Resolution**

PBSetOutput2Resolution,IP address,1024 768 60

Example:

PBSetOutput2Resolution,10.169.10.65,1920 1080 60

Sets the resolution of output 2 of the PB computer with the IP address 10.169.10.65 to 1920x1080 px and 60 Hz.

Please note:

All PB commands will only work when the Onscreen Menu up from Rev. 34 is installed on the computers!

### ▼ **PBDeactivateOutput2**

PBDeactivateOutput2,IP address

Example:

PBDeactivateOutput2,10.169.10.65

Deactivates output 2 of the PB computer with the IP address 10.169.10.65.

Please note:

All PB commands will only work when the Onscreen Menu up from Rev. 34 is installed on the computers!

---

### ▼ PBSetIP1

PBSetIP1,IP address,NewIP,NewMask

Example:

PBSetIP1,10.169.10.65,2.0.0.115,255.255.255.0

Changes the first IP address of the PB computer with the IP address 10.169.10.65 to the IP 2.0.0.115 with the subnet mask 255.255.255.0.

Please note:

All PB commands will only work when the Onscreen Menu up from Rev. 34 is installed on the computers!

### ▼ PBSetIP1DHCP

PBSetIP1DHCP,IP address

Example:

PBSetIP1DHCP,2.0.0.111

Sets the first network adapter of the PB computer with the IP address 2.0.0.111 to DHCP.

Please note:

All PB commands will only work when the Onscreen Menu up from Rev. 34 is installed on the computers!

### ▼ PBSetIP2

PBSetIP2,IP address,NewIP,NewMask

Example:

PBSetIP2,10.169.10.65,2.0.0.115,255.255.255.0

Changes the second IP address of the PB computer with the IP address 10.169.10.65 to the IP 2.0.0.115 with the subnet mask 255.255.255.0

Please note:

All PB commands will only work when the Onscreen Menu up from Rev. 34 is installed on the computers!

### ▼ PBSetIP2DHCP

PBSetIP2DHCP,IP address

Example:

PBSetIP2DHCP,2.0.0.111

Sets the second network adapter of the PB computer with the IP address 2.0.0.111 to DHCP.

Please note:

All PB commands will only work when the Onscreen Menu up from Rev. 34 is installed on the computers!

▼ **PBApplicationStartAll**

PBApplicationStartAll,Filepath

Example:

PBApplicationStartAll,notepad.exe

Opens the notepad on all PB computers in the local network.

If the application you want to start is not a standard windows application, please use the whole file path.

Example:

PBApplicationStartAll,C:\Program Files\Internet Explorer\iexplore.exe

Please note:

All PB commands will only work when the Onscreen Menu up from Rev. 34 is installed on the computers!

▼ **PBApplicationCloseAll**

PBApplicationCloseAll,Processname

Example:

PBApplicationCloseAll,notepad

Closes the running notepad application on all PB computers in the local network. Please have a look into the windows taskmanager to get the correct process name of the running application you want to close, enter this name without ".exe".

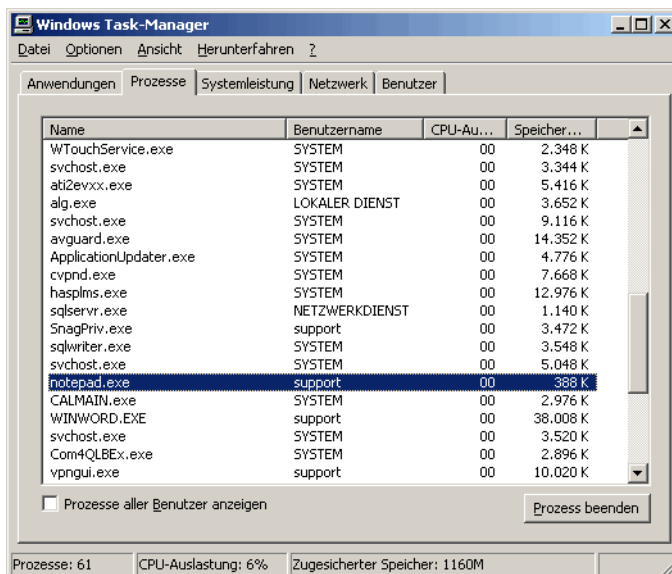

Please note:

All PB commands will only work when the Onscreen Menu up from Rev. 34 is installed on the computers!

▼ **PBApplicationStart**

PBApplicationStart,IP address,Filepath

Example:

PBApplicationStart,10.169.10.60,notepad.exe

Opens the notepad on the PB computers with the IP address 10.169.10.60 in the local network. If the application you want to start is not a standard windows application, please use the whole file path.

Example:

PBApplicationStart,10.169.10.60,C:\Program Files\Internet Explorer\iexplore.exe

Please note:

All PB commands will only work when the Onscreen Menu up from Rev. 34 is installed on the computers!

▼ **PBApplicationClose**

PBApplicationClose,IP address,Processname

Example:

PBApplicationClose,with the IP address 10.169.10.60,notepad

Closes the running notepad application on the PB computer with the IP address 10.169.10.60 in the local network. Please have a look into the windows taskmanager to get the correct process name of the running application you want to close, enter this

name without ".exe".

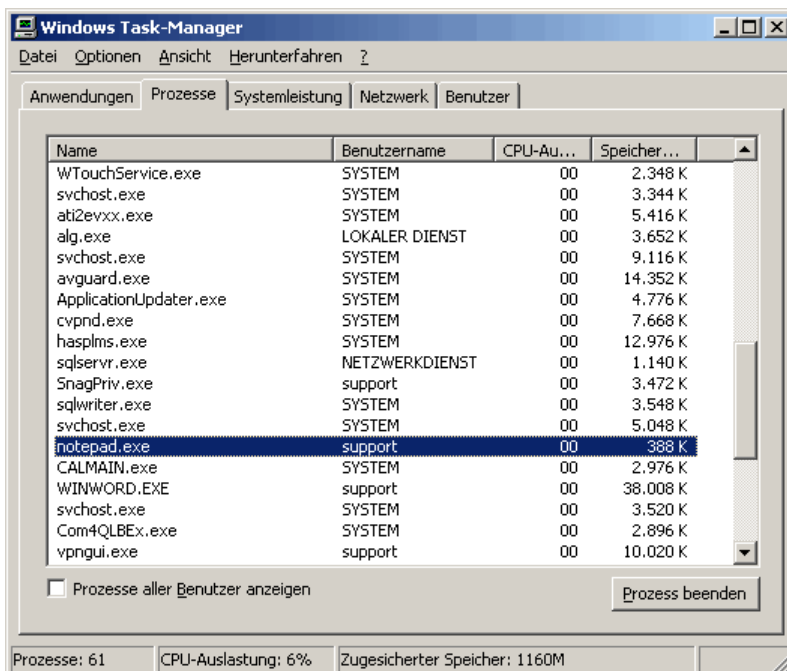

Please note:

All PB commands will only work when the Onscreen Menu up from Rev. 34 is installed on the computers!

### ▼ **WDDisconnect**

WDDisconnect

Example:

WDDisconnect

Disconnects Widget Designer from both the Pandoras Box Master and Backup. To connect to PB Master or Client System again, please go to [Network Setup](#)<sup>865</sup> in WD or use the WD command [WDDisconnect.IP.Domain](#)<sup>1311</sup>, [WDDisconnectMaster](#)<sup>1311</sup> or [WDDisconnectBackup](#)<sup>1311</sup>.

### ▼ **WDCConnect**

WDCConnect,IP,Domain

Example:

WDCConnect,10.169.10.65,0

Connects the Widget Designer to Pandoras Box with the IP address 10.169.10.65. The connection could also be set up via [IP Configuration](#)<sup>865</sup> in WD.

### ▼ **WDCConnectBackup**

WDCConnectBackup

Example:

WDCConnectBackup

Connects the Widget Designer to the Pandoras Box Backup after it was disconnected, see [IP Configuration](#)<sup>865</sup> in WD.

### ▼ **WDDisconnectMaster**

WDDisconnectMaster

Example:

WDDisconnectMaster

Disconnects the Widget Designer from Pandoras Box Master, see [IP Configuration](#)<sup>865</sup> in WD.

### ▼ **WDCConnectMaster**

WDCConnectMaster

Example:

WDCConnectMaster

Connects the Widget Designer to the Pandoras Box Master after it was disconnected, see [IP Configuration](#)<sup>865</sup> in WD.

---

### ▼ **WDDisconnectBackup**

WDDisconnectBackup

Example:

WDDisconnectBackup

Disconnects the Widget Designer from Pandoras Box Backup, see [IP Configuration](#)<sup>865</sup> in WD.

### ▼ **WDAirScanMouseEnabled**

WDAirScanMouseEnabled

Example:

WDAirScanMouseEnabled

Enables the AirScan to control the mouse, see [AirScan Tool](#)<sup>1156</sup>.

### ▼ **WDAirScanMouseDisabled**

WDAirScanMouseDisabled

Example:

WDAirScanMouseDisabled

Disables the AirScan to control the mouse, see [AirScan Tool](#)<sup>1156</sup>.

### ▼ **WDAirScanMouseClickEnabled**

WDAirScanMouseClickEnabled

Example:

WDAirScanMouseClickEnabled

With this option the mouse cursor (controlled via AirScan) generates clicks, see [AirScan Tool](#)<sup>1156</sup>.

### ▼ **WDAirScanMouseClickDisabled**

WDAirScanMouseClickDisabled

Example:

WDAirScanMouseClickDisabled

With this option the mouse cursor (controlled via AirScan) does not generate clicks, see [AirScan Tool](#)<sup>1156</sup>.

### ▼ **WDAirScanMouseClickDefault**

WDAirScanMouseClickDefault



Example:

WDAirScanMouseClickedDefault

This command defines when a mouse click (controlled via AirScan) should be executed. "Default" generates mouse down on enter and mouse up on leave.

Please note:

The option Mouse Click in the [AirScan Tool](#)<sup>1156</sup> needs to be enabled!

#### ▼ **WDAirScanMouseClickedOnEnter**

WDAirScanMouseClickedOnEnter

Example:

WDAirScanMouseClickedOnEnter

This command defines when a mouse click (controlled via AirScan) should be executed. "OnEnter": the click is generated on mouse enter.

Please note:

The option Mouse Click in the [AirScan Tool](#)<sup>1156</sup> needs to be enabled!

#### ▼ **WDAirScanMouseClickedOnLeave**

WDAirScanMouseClickedOnLeave

Example:

WDAirScanMouseClickedOnLeave

This command defines when a mouse click (controlled via AirScan) should be executed.

"OnLeave": the click is generated on mouse leave.

Please note:

The option Mouse Click in the [AirScan Tool](#)<sup>1156</sup> needs to be enabled!

#### ▼ **WDAirScanMouseDownOnMoveEnabled**

WDAirScanMouseDownOnMoveEnabled

Example:

WDAirScanMouseDownOnMoveEnabled

If this option is enabled, left mouse down on move is always active, see [AirScan Tool](#)<sup>1156</sup>.

#### ▼ **WDAirScanMouseDownOnMoveDisabled**

WDAirScanMouseDownOnMoveDisabled

Example:

WDAirScanMouseDownOnMoveDisabled

If this option is disabled, left mouse down on move is not active, see [AirScan Tool](#)<sup>1156</sup>.

---

**▼ WDAirScanMultiPointModeEnabled**

WDAirScanMultiPointModeEnabled

Example:

WDAirScanMultiPointModeEnabled

Enables the MultiPointMode in the [AirScan Tool](#)<sup>1156</sup>.

**▼ WDAirScanMultiPointModeDisabled**

WDAirScanMultiPointModeDisabled

Example:

WDAirScanMultiPointModeDisabled

Disables the MultiPointMode in the [AirScan Tool](#)<sup>1156</sup>, so that the 2-Point-Mode will be used.

**▼ WDAirScanPointCount**

WDAirScanPointCount,PointCount

Example:

WDAirScanPointCount,12

Changes the amount of detected touch points inside the [AirScan Tool](#)<sup>1156</sup> to 12.

**▼ WDAirScanDamping**

WDAirScanDamping,Value

Example:

WDAirScanDamping,0.5

Changes the value "Damping" inside the [AirScan Tool](#)<sup>1156</sup> to 0.5.

**▼ WDAirScanMotion**

WDAirScanMotion,Value

Example:

WDAirScanMotion,0.5

Changes the value "Motion" (motion damping) inside the [AirScan Tool](#)<sup>1156</sup> to 0.5.

**▼ WDAirScanPointIDOffset**

WDAirScanPointIDOffset,Value

Example:

WDAirScanPointIDOffset,2

---

Changes the value "Point ID Offset" inside the [AirScan Tool](#)<sup>1156</sup> to 2.

#### ▼ **WDAirScanTrim**

WDAirScanTrim,Value

Example:  
WDAirScanTrim,25

Changes the value "Trim" inside the [AirScan Tool](#)<sup>1156</sup> to 25.

#### ▼ **WDAirScanVCount**

WDAirScanVCount,Value

Example:  
WDAirScanVCount,5

Changes the value "VCount" inside the [AirScan Tool](#)<sup>1156</sup> to 5.

#### ▼ **WDAirScanGap**

WDAirScanGap,Value

Example:  
WDAirScanGap,20

Changes the value "Gap" inside the [AirScan Tool](#)<sup>1156</sup> to 20.

#### ▼ **WDAirScanMaxDelta**

WDAirScanMaxDelta,Value

Example:  
WDAirScanMaxDelta,50

Changes the value "Max Delta" inside the [AirScan Tool](#)<sup>1156</sup> to 50.

#### ▼ **WDAirScanXOffset**

WDAirScanXOffset,Value

Example:  
WDAirScanXOffset,1025

Changes the value "X Offset" inside the [AirScan Tool](#)<sup>1156</sup> to 50.

#### ▼ **WDAirScanYOffset**

WDAirScanYOffset,Value

Example:  
WDAirScanYOffset,769

Changes the value "Y Offset" inside the [AirScan Tool](#)<sup>1156</sup> to 50.

#### ▼ **WDAirScanStart**

WDAirScanStart,Value

Example:  
WDAirScanStart,50

Changes the value "Start" inside the [AirScan Tool](#)<sup>1156</sup> to 50.

#### ▼ **WDAirScanStop**

WDAirScanStop,Value

Example:  
WDAirScanStop,250

Changes the value "Stop" inside the [AirScan Tool](#)<sup>1156</sup> to 250.

#### ▼ **WDAirScanMotionPredictionEnable**

WDAirScanMotionPredictionEnable

Example:  
WDAirScanMotionPredictionEnable

Enables the option "Motion Prediction" inside the [AirScan Tool](#)<sup>1156</sup>.

#### ▼ **WDAirScanMotionPredictionDisable**

WDAirScanMotionPredictionDisable

Example:  
WDAirScanMotionPredictionDisable

Disables the option "Motion Prediction" inside the [AirScan Tool](#)<sup>1156</sup>.

#### ▼ **WDAirScanMotionPredictionFactor**

WDAirScanMotionPredictionFactor,Value

Example:  
WDAirScanMotionPredictionFactor,0.5

Changes the value "Motion Prediction" inside the [AirScan Tool](#)<sup>1156</sup> to 0.5.

#### ▼ **WDAirScanTUIOEnable**

WDAirScanTUIOEnable

Example:

WDAirScanTUIOEnable

Changes the amount of detected touch points inside the [AirScan Tool](#)<sup>1156</sup> to 12.

#### ▼ WDAirScanTUIODisable

WDAirScanTUIODisable

Example:

WDAirScanTUIODisable

Disables the option "TUIO" inside the [AirScan Tool](#)<sup>1156</sup>.

#### ▼ WDAirScanEnableTouch

WDAirScanEnableTouch

Example:

WDAirScanEnableTouch

Enables the option inside the [AirScan Tool](#)<sup>1156</sup> to send touch points to other controls like the [Multi-Touch Panel](#)<sup>936</sup>. Note that there is no check box for that option.

#### ▼ WDAirScanDisableTouch

WDAirScanDisableTouch

Example:

WDAirScanDisableTouch

Disables the option inside the [AirScan Tool](#)<sup>1156</sup> to send touch points to other controls like the [Multi-Touch Panel](#)<sup>936</sup>. Note that there is no check box for that option.

#### ▼ OpenAirscanProperties

OpenAirscanProperties

Example:

OpenAirscanProperties

Opens the [AirScan Tool](#)<sup>1156</sup> in WD.

#### ▼ WDArtNetSnapshotActivate

WDArtNetSnapshotActivate, ID

Example:

WDArtNetSnapshotActivate, 1

Executes the [Art-Net Snapshot](#)<sup>896</sup> Button 1. This command does stop current fades of other running Art-Net snapshots beforehand. This is an advantage when using multiple buttons in the *same* universe. Art-Net always transmits the entire universe, not only programmed channels (not specified channels=0). If current fades are not stopped, all channels would bounce between the fade value and 0.

When multiple snapshots apply to *different* universes, this command has the disadvantage to stop a channel's fade in between without setting it to a new value. In that scenario, please use the command `WDArtNetSnapshotActivateAllFade, ID`.

#### ▼ **WDArtNetSnapshotActivateAllFade**

`WDArtNetSnapshotActivateAllFade, ID`

Example:

`WDArtNetSnapshotActivateAllFade, 1`

Executes the [Art-Net Snapshot](#)<sup>896</sup> Button 1. This command does not stop current fades of other running Art-Net snapshots beforehand. This is an advantage when using multiple buttons in *different* universes.

When multiple buttons apply to the *same* universe, please use the command

`WDArtNetSnapshotActivate, ID` as this stops all fades beforehand. See [Art-Net Snapshot](#)<sup>896</sup>.

#### ▼ **WDArtNetSnapshotCut**

`WDArtNetSnapshotCut, ID`

Example:

`WDArtNetSnapshotCut, 1`

This applies the stored values of [Art-Net Snapshot](#)<sup>896</sup> Button 1 directly without fading.

#### ▼ **WDArtNetSnapshotSet8Bit**

`WDArtNetSnapshotSet8Bit, ID, Ch, Val`

Example:

`WDArtNetSnapshotSet8Bit, 1, 50, 255`

This command allows to change the stored value of the 8Bit Art-Net channel 50 to the value 255 in the [Art-Net Snapshot](#)<sup>896</sup> Button 1.

#### ▼ **WDArtNetSnapshotSet16Bit**

`WDArtNetSnapshotSet16Bit, ID, Ch, Val`

Example:

`WDArtNetSnapshotSet16Bit, 1, 50, 255`

This command allows to change the stored value of the 16Bit Art-Net channel 50 to the value 255 in the [Art-Net Snapshot](#)<sup>896</sup> Button 1

### ▼ **WDArtNetSnapshotCapture**

WDArtNetSnapshotCapture, ID

Example:

WDArtNetSnapshotCapture, 1

[Art-Net Snapshot](#)<sup>896</sup> Button 1 captures the current Art-Net status of the Art-Net Subnet and Universe set up in the Button Properties and overwrites the Art-Net values stored to this button before. If you like to merge the values (HTP), use the command

WDArtNetSnapshotHTPMerge, ID, Subnet, Universe.

### ▼ **WDArtNetSnapshotStopFade**

WDArtNetSnapshotStopFade, ID

Example:

WDArtNetSnapshotStopFade, 1

This stops the fade executed from [Art-Net Snapshot](#)<sup>896</sup> Button 1. The programmed channel(s) simply stop at their current value.

### ▼ **WDArtNetSnapshotStopAllFades**

WDArtNetSnapshotStopAllFades

Example:

WDArtNetSnapshotStopAllFades

This stops all fades executed through currently running [Art-Net Snapshot](#)<sup>896</sup> Buttons. The programmed channel(s) simply stop at their current value.

### ▼ **WDArtNetSnapshotClear**

WDArtNetSnapshotClear, ID

Example:

WDArtNetSnapshotClear, 1

This clears the programmed channel(s) from [Art-Net Snapshot](#)<sup>896</sup> Button 1. If the button is then clicked, all values for the specified universe would fade to 0.

### ▼ **WDArtNetSnapshotHTPMerge**

WDArtNetSnapshotHTPMerge, ID, Subnet, Universe

Example:

WDArtNetSnapshotHTPMerge, 1, 2, 3

[Art-Net Snapshot](#)<sup>896</sup> Button 1 captures the current Art-Net status of the Art-Net Subnet 2 and Universe 3 and merges the status with the status stored to this button before. The merge uses the

method HTP: highest takes precedence, meaning that the largest value is stored. If you like to overwrite the values (i.e. LTP), use the command `WDArtNetSnapshotCapture, ID`.

### ▼ **WDArtnetSnapshotImage**

WDArtnetSnapshotImage, ID, File

Example:

```
WDArtnetSnapshotImage, 1, C:\coolux\content\buttonImage10.jpg
```

Changes the look of the [Art-Net Snapshot](#)<sup>896</sup> Button with ID 1 - it loads the image "buttonImage10.jpg" that was saved under "C:\coolux\content" and displays it when the Art-Net Snapshot is in the mode "Release".

### ▼ **WDArtnetSnapshotClickImage**

WDArtnetSnapshotClickImage, ID, File

Example:

```
WDArtnetSnapshotClickImage, 1, C:\coolux\content\buttonImage10.jpg
```

Changes the look of the [Art-Net Snapshot](#)<sup>896</sup> Button with ID 1 - it loads the image "buttonImage10.jpg" that was saved under "C:\coolux\content" and displays it when the Art-Net Snapshot is in the mode "Click".

### ▼ **WDArtnetSnapshotMouseOverImage**

WDArtnetSnapshotMouseOverImage, ID, File

Example:

```
WDArtnetSnapshotMouseOverImage, 1, C:\coolux\content\buttonImage10.jpg
```

Changes the look of the [Art-Net Snapshot](#)<sup>896</sup> Button with ID 1 - it loads the image "buttonImage10.jpg" that was saved under "C:\coolux\content" and displays it when the Art-Net Snapshot is in the mode "Highlight".

### ▼ **WDArtNetRecorderPlay**

WDArtNetRecorderPlay, ID

Example:

```
WDArtNetRecorderPlay, 2
```

Plays the Art-Net sequence recorded with [Art-Net Recorder](#)<sup>898</sup> Button 2 from it's current time.

### ▼ **WDArtNetRecorderPause**

WDArtNetRecorderPause, ID



Example:

WDArtNetRecorderPause,2

Pauses the playing Art-Net sequence recorded with [Art-Net Recorder](#)<sup>898</sup> Button 2.

#### ▼ WDArtNetRecorderRewind

WDArtNetRecorderRewind,ID

Example:

WDArtNetRecorderRewind,2

Rewinds the Art-Net sequence recorded with [Art-Net Recorder](#)<sup>898</sup> Button 2 to it's inpoint. When the sequence is currently playing, it won't be stopped but starts from it's beginning again.

#### ▼ WDArtNetRecorderLoop

WDArtNetRecorderLoop,ID

Example:

WDArtNetRecorderLoop,2

Sets the playmode of the Art-Net sequence recorded with [Art-Net Recorder](#)<sup>898</sup> Button 2 to Loop.

#### ▼ WDArtNetRecorderPlayOnce

WDArtNetRecorderPlayOnce,ID

Example:

WDArtNetRecorderPlayOnce,2

Sets the playmode of the Art-Net sequence recorded with [Art-Net Recorder](#)<sup>898</sup> Button 2 to PlayOnce.

#### ▼ WDArtNetRecorderGotoFrame

WDArtNetRecorderGotoFrame,ID,Frame

Example:

WDArtNetRecorderGotoFrame,1,330

Sets the [Art-Net Recorder](#)<sup>898</sup> Button 1 to the frame 330 of the last recorded Art-Net Sequence.

#### ▼ WDArtNetRecorderStart

WDArtNetRecorderStart,ID

Example:

WDArtNetRecorderStart,1

Starts the recording of [Art-Net Recorder](#)<sup>898</sup> Button 1.

### ▼ **WDArtNetRecorderStop**

WDArtNetRecorderStop, ID

Example:

WDArtNetRecorderStop, 1

Stops the recording of [Art-Net Recorder](#)<sup>898</sup> Button 1.

### ▼ **WDArtnetRecorderImage**

WDArtnetRecorderImage, ID, File

Example:

WDArtnetRecorderImage, 1, C:\coolux\content\buttonImage10.jpg

Changes the look of the [Art-Net Recorder](#)<sup>898</sup> Button with ID 1 - it loads the image "buttonImage10.jpg" that was saved under "C:\coolux\content" and displays it when the Art-Net Recorder is in the mode "Release".

### ▼ **WDArtnetRecorderClickImage**

WDArtnetRecorderClickImage, ID, File

Example:

WDArtnetRecorderClickImage, 1, C:\coolux\content\buttonImage10.jpg

Changes the look of the [Art-Net Recorder](#)<sup>898</sup> Button with ID 1 - it loads the image "buttonImage10.jpg" that was saved under "C:\coolux\content" and displays it when the Art-Net Recorder is in the mode "Click".

### ▼ **WDArtnetRecorderMouseOverImage**

WDArtnetRecorderMouseOverImage, ID, File

Example:

WDArtnetRecorderMouseOverImage, 1, C:\coolux\content\buttonImage10.jpg

Changes the look of the [Art-Net Recorder](#)<sup>898</sup> Button with ID 1 - it loads the image "buttonImage10.jpg" that was saved under "C:\coolux\content" and displays it when the Art-Net Recorder is in the mode "Highlight".

### ▼ **WDButtonClick**

WDButtonClick, ID

Example:

WDButtonClick, ID

This clicks the Button with ID 1. Please note, that this command refers to legacy versions including the item "Button". If you like to click a Custom Script Button instead, use the command [WDCustomScriptClick, ID](#)<sup>1326</sup>.

### ▼ **WDButtonText**

WDButtonText, ID, Text

Example:

WDButtonText, 1, Flip

This labels the Button with ID 1 with the word "Flip". Please note, that this command refers to legacy versions including the item "Button". If you like to label a Custom Script Button instead, use the command [WDCustomScriptText, ID, Text](#)<sup>1330</sup>.

### ▼ **WDButtonTextColour**

WDButtonTextColour, ID, R, G, B

Example:

WDButtonTextColour, 1, 255, 90, 0

This changes the text color of the Button with ID 1 to orange. The values for R, G, B range from 0 to 255. Please note, that this command refers to legacy versions including the item "Button". If you like to change a Custom Script Button instead, use the command [WDCustomScriptTextColour, ID, R, G, B](#)<sup>1331</sup>.

### ▼ **WDColourPickerDevices**

WDColourPickerDevices, ID, 1.1 1.2 1.3

Example:

WDColourPickerDevices, 6, 1.1 2.4

Transfers the RGB-values of the Colour Picker with the ID 6 in WD to the Colour FX fader 1-3 of layers 1, 1 and 2, 4 in PB (before version 5!), see [Colour Picker](#)<sup>921</sup>.

### ▼ **WDColourPickerBGColour**

WDColourPickerBGColour, ID, R, G, B

Example:

WDColourPickerBGColour, 6, 255, 90, 0

Changes the background colour of the Colour Picker with the ID 6 in WD to orange. The values for R, G, B range from 0 to 255. See [Colour Picker](#)<sup>921</sup>.

### ▼ **WDControlShow**

WDControlShow, ControlName

Example:

WDControlShow, Customscript2

Shows the Custom Script Button 2 outside of its page context

---

This way you can show a control that originates from another page. This may be done e.g. as On [Page](#)<sup>880</sup> Enter or Leave script.

### ▼ **WDControlHide**

WDControlHide,ControlName

Example:

WDControlHide,Customscript2

Hides Custom Script Button 2 outside of its page context

This way you can hide a control that originates from another page. This may be done e.g. as On [Page](#)<sup>880</sup> Enter or Leave script.

### ▼ **WDControlBringToFront**

WDControlBringToFront,ControlName

Example:

WDControlBringToFront,Customscript2

Changes the Z-Order and brings Custom Script Button 2 to the front.

### ▼ **WDControlSendToBack**

WDControlSendToBack,ControlName

Example:

WDControlSendToBack,Customscript2

Changes the Z-Order and sends Custom Script Button 2 to the back.

### ▼ **WDCueListGo**

WDCueListGo,ID

Example:

WDCueListGo,1

Starts the next Cue in CueList 1, see [CueList](#)<sup>908</sup>.

### ▼ **WDCueListPause**

WDCueListPause,ID

Example:

WDCueListPause,1

Pauses the CueList 1, see [CueList](#)<sup>908</sup>.

---

**▼ WDCueListGo-**

WDCueListGo-,ID

Example:  
WDCueListPause,1

Goes one step back in CueList 1, see [CueList](#)<sup>908</sup>.

**▼ WDCueListRecall**

WDCueListRecall,ID

Example:  
WDCueListRecall,1

Recalls the current cue in CueList 1: sets the Cue back to its beginning and keeps the state of the Cuelist (play / pause) , see [CueList](#)<sup>908</sup>.

**▼ WDCueListGotoCue**

WDCueListGotoCue,ID,Cue

Example:  
WDCueListGotoCue,1,5

Jumps to Cue 5 in CueList 1, see [CueList](#)<sup>908</sup>.

**▼ WDCueListPrevCue**

WDCueListPrevCue,ID

Example:  
WDCueListPrevCue,1

Goes back cue by cue in Cuelist 1 without running the Cue, see [CueList](#)<sup>908</sup>.

**▼ WDCueListNextCue**

WDCueListNextCue,ID

Example:  
WDCueListNextCue,1

Goes forward cue by cue in Cuelist 1 without running the Cue, see [CueList](#)<sup>908</sup>.

**▼ WDCueListFirstCue**

WDCueListFirstCue,ID

Example:

WDCueListFirstCue,1

Goes to the first cue in Cuelist 1 without running it, see [CueList](#)<sup>908</sup>.

#### ▼ **WDCueListLastCue**

WDCueListLastCue,ID

Example:

WDCueListLastCue,1

Goes to the last cue in Cuelist 1 without running it, see [CueList](#)<sup>908</sup>.

#### ▼ **WDCueListResetJumps**

WDCueListResetJumps,ID

Example:

WDCueListResetJumps,1

Sets the Jump Counter of every cue in CueList 1 back to 0, see [CueList](#)<sup>908</sup>.

#### ▼ **WDCueListCancelWaits**

WDCueListCancelWaits,ID

Example:

WDCueListCancelWaits,1

Cancel the current Wait time but does not continue executing the CueList , see [CueList](#)<sup>908</sup>.

#### ▼ **WDCustomScriptClick**

WDCustomScriptClick,ID

Example:

WDCustomScriptClick,5

Clicks the [Custom Script Button](#)<sup>884</sup> with the ID 5. If the type of Custom Script Button 5 is "Toggle" the command toggles the button.

Works for the Custom Script Button's type: Click, Flash, Toggle  
Works for the Custom Script Button's state: Released or Clicked  
Executes associated script: "On Click" or "On Release"

#### ▼ **WDCustomScriptClickToggle**

WDCustomScriptClickToggle,ID

Example:

WDCustomScriptClickToggle,5

Sets the [Custom Script Button](#)<sup>884</sup> with ID 5 in the released mode and executes all commands. This works only for Toggle Buttons which are in the Clicked mode.

Works for the Custom Script Button's type: Toggle, not: Click, Flash,  
Works for the Custom Script Button's state: Clicked, not: Released  
Toggles the Toggle Custom Script Button's state: yes, to Released  
Executes associated script: yes, "On Release"

### ▼ **WDCustomScriptReleaseToggle**

WDCustomScriptReleaseToggle,ID

Example:

WDCustomScriptReleaseToggle,5

Clicks the [Custom Script Button](#)<sup>884</sup> with ID 5 and executes all commands. If it is a "Toggle" button, the script works only if it is in Released mode.

Works for the Custom Script Button's type: Click, Flash, Toggle  
Works for the Custom Script Button's state: Released; not: Clicked  
Toggles the Toggle Custom Script Button's state: yes, to Clicked  
Executes associated script: yes, "On Click" ("On Release" only for a Flash button)

### ▼ **WDCustomScriptSilentClickToggle**

WDCustomScriptSilentClickToggle,ID

Example:

WDCustomScriptSilentClickToggle,5

Sets the [Custom Script Button](#)<sup>884</sup> with ID 5 in the released mode without executing commands. This works only for Toggle Buttons which are in the Clicked mode.

Works for the Custom Script Button's type: Toggle, not: Click, Flash  
Works for the Custom Script Button's state: Clicked, not: Released  
Toggles the Toggle Custom Script Button's state: yes, to Released  
Executes associated script: no

### ▼ **WDCustomScriptSilentReleaseToggle**

WDCustomScriptSilentReleaseToggle,ID

Example:

WDCustomScriptSilentReleaseToggle,5

Clicks the [Custom Script Button](#)<sup>884</sup> with ID 5 without executing commands. This works only for Toggle Buttons which are in the Released mode.

Works for the Custom Script Button's type: Toggle, not: Click, Flash  
Works for the Custom Script Button's state: Released; not: Clicked  
Toggles the Toggle Custom Script Button's state: yes, to Clicked  
Executes associated script: no

### ▼ **WDCustomScriptSilentClickToggleAll**

WDCustomScriptSilentClickToggleAll

Example:

WDCustomScriptSilentClickToggleAll

Sets all [Custom Script Buttons](#)<sup>884</sup> in the released mode without executing commands. This works only for Toggle Buttons which are in the Clicked mode.

Works for the Custom Script Button's type: Toggle, not: Click, Flash

Works for the Custom Script Button's state: Clicked, not: Released

Toggles the Toggle Custom Script Button's state: yes, to Released

Executes associated script: no

### ▼ **WDCustomScriptSilentClickToggleAllBut**

WDCustomScriptSilentClickToggleAllBut,ID1,ID2,...

Example:

WDCustomScriptSilentClickToggleAllBut,5,9,12

Sets all [Custom Script Buttons](#)<sup>884</sup> except ID 5,9 and 12 in the released mode without executing commands. This works only for Toggle Buttons which are in the Clicked mode.

Works for the Custom Script Button's type: Toggle, not: Click, Flash

Works for the Custom Script Button's state: Clicked, not: Released

Toggles the Toggle Custom Script Button's state: yes, to Released

Executes associated script: no

### ▼ **WDCustomScriptSilentReleaseToggleAll**

WDCustomScriptSilentReleaseToggleAll

Example:

WDCustomScriptSilentReleaseToggleAll

Clicks all [Custom Script Button](#)<sup>884</sup> without executing commands. This works only for Toggle Buttons which are in the Released mode.

Works for the Custom Script Button's type: Toggle, not: Click, Flash

Works for the Custom Script Button's state: Released; not: Clicked

Toggles the Toggle Custom Script Button's state: yes, to Clicked

Executes associated script: no

### ▼ **WDCustomScriptSilentReleaseToggleAllBut**

WDCustomScriptSilentReleaseToggleAllBut,ID1,ID2,...

Example:

WDCustomScriptSilentReleaseToggleAllBut,5,9,12



Clicks all [Custom Script Button](#)<sup>884</sup> except ID 5,9 and 12 without executing commands. This works only for Toggle Buttons which are in the Released mode.

Works for the Custom Script Button's type: Toggle, not: Click, Flash  
 Works for the Custom Script Button's state: Released; not: Clicked  
 Toggles the Toggle Custom Script Button's state: yes, to Clicked  
 Executes associated script: no

### ▼ **WDCustomScriptSilentClickTogglePage**

WDCustomScriptSilentClickTogglePage,PageName

Example:

WDCustomScriptSilentClickTogglePage,Showroom2

Sets all [Custom Script Buttons](#)<sup>884</sup> from page "Showroom2" in the released mode without executing commands. This works only for Toggle Buttons which are in the Clicked mode.

Works for the Custom Script Button's type: Toggle, not: Click, Flash  
 Works for the Custom Script Button's state: Clicked, not: Released  
 Toggles the Toggle Custom Script Button's state: yes, to Released  
 Executes associated script: no

### ▼ **WDCustomScriptSilentReleaseTogglePage**

WDCustomScriptSilentReleaseTogglePage,PageName

Example:

WDCustomScriptSilentReleaseTogglePage,Showroom2

Clicks all [Custom Script Button](#)<sup>884</sup> from page "Showroom2" without executing commands. This works only for Toggle Buttons which are in the Released mode.

Works for the Custom Script Button's type: Toggle, not: Click, Flash  
 Works for the Custom Script Button's state: Released; not: Clicked  
 Toggles the Toggle Custom Script Button's state: yes, to Clicked  
 Executes associated script: no

### ▼ **WDCustomScriptExecuteClick**

WDCustomScriptExecuteClick,ID

Example:

WDCustomScriptExecuteClick,5

Executes the "On Click Script" of [Custom Script Button](#)<sup>884</sup> with ID 5 without changing its Clicked / Released mode.

Works for the Custom Script Button's type: Click, Flash, Toggle  
 Works for the Custom Script Button's state: Clicked, Released  
 Toggles the Toggle Custom Script Button's state: no  
 Executes script: yes, only "On Click"

### ▼ WDCustomScriptExecuteRelease

WDCustomScriptExecuteRelease,ID

Example:

WDCustomScriptExecuteRelease,5

Executes the "On Release Script" of [Custom Script Button](#)<sup>884</sup> with ID 5 without changing its Clicked / Released mode.

Works for the Custom Script Button's type: Flash, Toggle, not: Click

Works for the Custom Script Button's state: Clicked, Released

Toggles the Toggle Custom Script Button's state: no

Executes script: yes, only "On Release"

### ▼ WDCustomScriptExecuteEnter

WDCustomScriptExecuteEnter,ID

Example:

WDCustomScriptExecuteEnter,5

Executes the "On Mouse Enter Script" of [Custom Script Button](#)<sup>884</sup> with ID 5.

Works for the Custom Script Button's type: Click, Flash, Toggle

Works for the Custom Script Button's state: Clicked, Released

Toggles the Toggle Custom Script Button's state: no

Executes script: yes, only "On Enter"

### ▼ WDCustomScriptExecuteLeave

WDCustomScriptExecuteLeave,ID

Example:

WDCustomScriptExecuteLeave,5

Executes the "On Mouse Leave Script" of [Custom Script Button](#)<sup>884</sup> with ID 5.

Works for the Custom Script Button's type: Click, Flash, Toggle

Works for the Custom Script Button's state: Clicked, Released

Toggles the Toggle Custom Script Button's state: no

Executes script: yes, only "On Leave"

### ▼ WDCustomScriptText

WDCustomScriptText,ID,Text

Example:

WDCustomScriptText,3,Flip

Labels the [Custom Script Button](#)<sup>884</sup> with the ID 3 with the word "Flip".

### ▼ **WDCustomScriptTextColour**

WDCustomScriptTextColour,ID,R,G,B

Example:

WDCustomScriptTextColour,3,255,90,0

Changes the text colour of the [Custom Script Button](#)<sup>884</sup> with the ID 3 to orange. The values for R,G,B range from 0 to 255.

### ▼ **WDCustomScriptTextFromLabel**

WDCustomScriptTextFromLabel,CustomScriptID,ID

Example:

WDCustomScriptTextFromLabel,2,4

Labels the [Custom Script Button](#)<sup>884</sup> with the ID 4 with the text from [Label](#)<sup>931</sup> 2.

### ▼ **WDCustomScriptAddTextFromLabel**

WDCustomScriptAddTextFromLabel,CustomScriptID,ID

Example:

WDCustomScriptAddTextFromLabel,6,3

Adds the text from [Label](#)<sup>931</sup> 6 to the [Custom Script Button](#)<sup>884</sup> with the ID 3.

### ▼ **WDCustomScriptTint**

WDCustomScriptTint,ID,Red,Green,Blue

Example:

WDCustomScriptTint,5,0,255,0

This tints the [Custom Script Button](#)<sup>884</sup> with the ID 5 in green.

### ▼ **WDCustomScriptFix**

WDCustomScriptFix,ID

Example:

WDCustomScriptFix,3

Sets the option "Fix" for the [Custom Script Button](#)<sup>884</sup> with the ID 3, so that this CS Button is shown on every page inside WD now.

### ▼ **WDCustomScriptUnfix**

WDCustomScriptUnfix,ID

Example:

WDCustomScriptUnfix,3

Disables the option “Fix” for the [Custom Script Button](#)<sup>884</sup> with the ID 3, so that this CS Button is not shown on every page inside WD any more.

### ▼ WDDownloadThumbnails

WDDownloadThumbnails

Example:

WDDownloadThumbnails

Downloads all Thumbnails from the connected PB.

Please make sure that the function to [download Thumbnails](#)<sup>146</sup> from PB is enabled!

### ▼ WDDrawingCanvasClear

WDDrawingCanvasClear,ID

Example:

WDDrawingCanvasClear,1

Clears the interface of the Drawing Canvas with the ID 1.

### ▼ WDDrawingCanvasSetPenSize

WDDrawingCanvasSetPenSize,ID,Size

Example:

WDDrawingCanvasSetPenSize,1,16

Changes the current pen size of the Drawing Canvas with the ID 1 to the size 16.

### ▼ WDDrawingCanvasSetPenCol

WDDrawingCanvasSetPenCol,ID,Size

Example:

WDDrawingCanvasSetPenCol,1,255,0,0

Changes the current pen colour of the Drawing Canvas with the ID 1 to the colour R=255,G=0,B=0 (red).

### ▼ WDDrawingCanvasSetBGCol

WDDrawingCanvasSetBGCol,ID,Size

Example:

WDDrawingCanvasSetBGCol,1,255,0,100

Changes the current background colour of the Drawing Canvas with the ID 1 to the colour R=255,G=0,B=100 (pink).

### ▼ WDDropDownListSetIndex

WDDropDownListSetIndex, ID, Value

Example:

WDDropDownListSetIndex, 1, 3

In the [DropDownList](#)<sup>918</sup> with ID 1, the entry element with index 3 is selected. Note: The indexing starts with "0".

### ▼ WDDropDownListSetText

WDDropDownListSetText, ID, Text

Example:

WDDropDownListSetText, 1, Load File

Sets the default text of [DropDownList](#)<sup>918</sup> with ID 1 to "Load File".

### ▼ WDDropDownListSetItemsFromArray

WDDropDownListSetItemsFromArray, ID, VarName

Example:

WDDropDownListSetItemsFromArray, 1, var\_array

Fills the elements of [DropDownList](#)<sup>918</sup> with ID 1 with the values from the array-type [Variable](#)<sup>1193</sup> "var\_array".

### ▼ WDDropDownListSetItemsFromExcel

WDDropDownListSetItemsFromExcel, ID, File, Table, CellStart, CellEnd

Example:

WDDropDownListSetItemsFromExcel, 1, C:\coolux\content\drop\_down.xls, Sheet1, A1, A4

Fills the entry elements of [DropDownList](#)<sup>918</sup> with ID 1 with the values from cell A1 to A4, saved in the Excel file "drop\_down.xls", Sheet1.

Note: The Excel document has to be an .xls file. The file may take some seconds to load.

### ▼ WDEncoderGoUp

WDEncoderGoUp, ID, Value

Example:

WDEncoderGoUp, 7, 10

Adds immediately 10 values to the value of Encoder 7, see [Encoder](#)<sup>922</sup>.

---

**▼ WDEncoderGoDown**

WDEncoderGoDown, ID, Value

Example:

WDEncoderGoDown, 7, 10

Subtracts immediately 10 values from the value of Encoder 7, see [Encoder](#)<sup>922</sup>.

**▼ WDEncoderValue**

WDEncoderValue, ID, Value

Example:

WDEncoderValue, 7, 33

Sets the Encoder 7 to value 33 immediately, see [Encoder](#)<sup>922</sup>.

**▼ WDEncoderFactor**

WDEncoderFactor, ID, Value

Example:

WDEncoderFactor, 7, 5

Sets the factor of Encoder 7 to the value 5, see [Encoder](#)<sup>922</sup>.

**▼ WDEventCreate**

WDEventCreate, EventName

Example:

WDEventCreate, Show

Creates the [Event](#)<sup>1188</sup> "Show".

**▼ WDEventCreateWithCategory**

WDEventCreateWithCategory, EventName, Category

Example:

WDEventCreateWithCategory, Show, Start

Creates the [Event](#)<sup>1188</sup> "Show" with the Category "Start".

**▼ WDEventDeleteCategory**

WDEventDeleteCategory, Category

Example:

WDEventDeleteCategory, Start

---

Deletes all [Events](#)<sup>1188</sup> with the category “Start”.

#### ▼ **WDEventDeleteObsoleteItems**

WDEventDeleteObsoleteItems

Example:

WDEventDeleteObsoleteItems

Deletes passed [Events](#)<sup>1188</sup>.

#### ▼ **WDEventSingleEvent**

WDEventSingleEvent,EventName

Example:

WDEventSingleEvent,Show

The [Event](#)<sup>1188</sup> “Show” will not be repeated, it is a single event.

#### ▼ **WDEventEveryMinute**

WDEventEveryMinute,EventName

Example:

WDEventEveryMinute,Show

Repeats the [Event](#)<sup>1188</sup> “Show” every minute.

#### ▼ **WDEventEveryHour**

WDEventEveryHour,EventName

Example:

WDEventEveryHour,Show

Repeats the [Event](#)<sup>1188</sup> “Show” every hour.

#### ▼ **WDEventEveryDay**

WDEventEveryDay,EventName

Example:

WDEventEveryDay,Show

Repeats the [Event](#)<sup>1188</sup> “Show” every day.

#### ▼ **WDEventEveryWeek**

WDEventEveryWeek,EventName

Example:  
WDEventEveryWeek,Show

Repeats the [Event](#)<sup>1188</sup> “Show” every week.

### ▼ WDEventEveryMonth

WDEventEveryMonth,EventName

Example:  
WDEventEveryMonth,Show

Repeats the [Event](#)<sup>1188</sup> “Show” every month.

### ▼ WDEventEveryYear

WDEventEveryYear,EventName

Example:  
WDEventEveryYear,Show

Repeats the [Event](#)<sup>1188</sup> “Show” every year.

### ▼ WDEventStartDate

WDEventStartDate,EventName,YYYY,MM,DD,HH,MM,SS

Example:  
WDEventStartDate,Show,2015,12,24,20,00,00

Sets the start date of the [Event](#)<sup>1188</sup> “Show” to 8 p.m. at Christmas 2015.

### ▼ WDEventEndDate

WDEventEndDate,EventName,YYYY,MM,DD,HH,MM,SS

Example:  
WDEventEndDate,Show,2015,12,24,20,00,00

Sets the end date of the [Event](#)<sup>1188</sup> “Show” to 8 p.m. at Christmas 2015.

### ▼ WDEventScript

WDEventScript,EventName,Script

Example:  
WDEventScript,Show,WDFaderUp,1,3

Applies the command “WDFaderUp,1,3” to the [Event](#)<sup>1188</sup> “Show”.

### ▼ WDEventDelete



WDEventDelete,EventName

Example:

WDEventDelete,Show

Deletes the [Event](#)<sup>1188</sup> "Show".

#### ▼ **WDEventDeleteAll**

WDEventDeleteAll

Example:

WDEventDeleteAll

Deletes all [Events](#)<sup>1188</sup>.

#### ▼ **WDEventMute**

WDEventMute,EventName

Example:

WDEventMute,Show

Disables/Mutes the [Event](#)<sup>1188</sup> "Show".

#### ▼ **WDEventUnMute**

WDEventUnMute,EventName

Example:

WDEventUnMute,Show

Activates / Unmutes the [Event](#)<sup>1188</sup> "Show".

#### ▼ **WDFaderUp**

WDFaderUp,ID,Seconds

Example:

WDFaderUp,7,2

Fades Fader 7 in 2sec up to its maximum value, see [Fader](#)<sup>925</sup>.

#### ▼ **WDFaderDown**

WDFaderDown,ID,Seconds

Example:

WDFaderDown,7,2

Fades Fader 7 in 2sec down to its minimum value, see [Fader](#)<sup>925</sup>.

### ▼ WDFadeToValue

WDFadeToValue, ID, Seconds, Value

Example:

WDFadeToValue, 1, 4, 200

Fades Fader 1 in 4s to the value 200, see [Fader<sup>925</sup>](#).

### ▼ WDFadeToValueSmooth

WDFadeToValueSmooth, ID, Time, Value

Example:

WDFadeToValueSmooth, 2, 5, 170

Fades Fader 2 smoothly in 5sec up to value of 170, see [Fader<sup>925</sup>](#). "Smoothly" means that the motion is eased in and out, on start and stop of each fade.

### ▼ WDFadeToRelativeValue

WDFadeToRelativeValue, ID, Seconds, Value

Example:

WDFadeToRelativeValue, 6, 13, 41

Fades Fader 6 in 13sec to the result of its current value plus 41, see [Fader<sup>925</sup>](#).

### ▼ WDFadeToRelativeValueSmooth

WDFadeToRelativeValueSmooth, ID, Time, Value

Example:

WDFadeToRelativeValueSmooth, 6, 13, 41

Fades Fader 6 smoothly in 13sec to the result of its current value plus 41, see [Fader<sup>925</sup>](#). "Smoothly" means that the motion is eased in and out, on start and stop of each fade.

### ▼ WDFaderGoUp

WDFaderGoUp, ID, Value

Example:

WDFaderGoUp, 7, 10

Adds immediately 10 values to the value of Fader 7, see [Fader<sup>925</sup>](#).

### ▼ WDFaderGoDown

WDFaderGoDown, ID, Value

Example:  
WDFaderGoDown,7,10

Subtracts immediately 10 values from the value of Fader 7, see [Fader](#)<sup>925</sup>.

#### ▼ **WDFaderValue**

WDFaderValue,ID,Value

Example:  
WDFaderValue,7,33

Sets the Fader 7 to value 33 immediately, see [Fader](#)<sup>925</sup>.

#### ▼ **WDFaderAbortAllFades**

WDFaderAbortAllFades

Example:  
WDFaderAbortAllFades  
Abort all current fades, see [Fader](#)<sup>925</sup>.

#### ▼ **WDFaderAbortFade**

WDFaderAbortFade,ID

Example:  
WDFaderAbortFade,1

Aborts the fade of Fader 1, see [Fader](#)<sup>925</sup>.

#### ▼ **WDFaderFix**

WDFaderFix,ID

Example:  
WDFaderFix,2

Sets the option “Fix” for Fader 2, so that this Fader is shown on every page inside WD now. See [Fader](#)<sup>925</sup>.

#### ▼ **WDFaderUnfix**

WDFaderUnfix,ID

Example:  
WDFaderUnfix,2

Disables the option “Fix” for the Fader 2, so that this Fader is not shown on every page inside WD any more. See [Fader](#)<sup>925</sup>.

### ▼ **WDFaderBGImage**

WDFaderBGImage, ID, File

Example:

WDFaderBGImage, 1, C:\coolux\content\faderBG.png

Changes the look of Fader 1 - it loads the image "faderBG.png" that was saved under "C:\coolux\content" as the new background image. See [Fader<sup>925</sup>](#).

### ▼ **WDFaderHandleImage**

WDFaderHandleImage, ID, File

Example:

WDFaderHandleImage, 1, C:\coolux\content\faderHandle.png

Changes the look of the Fader with ID 1 - it loads the image "faderHandle.png" that was saved under "C:\coolux\content" as the new handle image. See [Fader<sup>925</sup>](#).

### ▼ **WDFaderMidiInputEnable**

WDFaderMidiInputEnable, ID

Example:

WDFaderMidiInputEnable, 3

Enables the MIDI input of [Fader<sup>925</sup>](#) 3.

### ▼ **WDFaderMidiInputDisable**

WDFaderMidiInputDisable, ID

Example:

WDFaderMidiInputDisable, 3

Disables the MIDI input of [Fader<sup>925</sup>](#) 3.

### ▼ **WDFaderMidiOutputEnable**

WDFaderMidiOutputEnable, ID

Example:

WDFaderMidiOutputEnable, 3

Enables the MIDI output of [Fader<sup>925</sup>](#) 3.

### ▼ **WDFaderMidiOutputDisable**

WDFaderMidiOutputDisable, ID

Example:  
WDFaderMidiOutputDisable,3

Disables the MIDI output of [Fader](#)<sup>925</sup> 3.

### ▼ **WDImageLoaderImage**

WDImageLoaderImage, ID, File

Example:  
WDImageLoaderImage, 1, C:\coolux\content\buttonImage10.jpg

Changes the look of the Image Loader Button with ID 1 - it loads the image "buttonImage10.jpg" that was saved under "C:\coolux\content" and displays it when the Image Loader is in the mode "Release". See [Image Loader](#)<sup>891</sup>.

### ▼ **WDImageLoaderClickImage**

WDImageLoaderClickImage, ID, File

Example:  
WDImageLoaderClickImage, 1, C:\coolux\content\buttonImage10.jpg

Changes the look of the Image Loader Button with ID 1 - it loads the image "buttonImage10.jpg" that was saved under "C:\coolux\content" and displays it when the Image Loader is in the mode "Click". See [Image Loader](#)<sup>891</sup>.

### ▼ **WDImageLoaderMouseOverImage**

WDImageLoaderClickMouseOverImage, ID, File

Example:  
WDImageLoaderMouseOverImage, 1, C:\coolux\content\buttonImage10.jpg

Changes the look of the Image Loader Button with ID 1 - it loads the image "buttonImage10.jpg" that was saved under "C:\coolux\content" and displays it when the Image Loader is in the mode "Highlight". See [Image Loader](#)<sup>891</sup>.

### ▼ **WDImageFile**

WDImageFile, ID, File

Example:  
WDImageFile, 1, C:\coolux\content\test1.jpg

Replaces the content of the image control with the ID 1 with the image "test1.jpg" from the path C:\coolux\content.

### ▼ **WDImageLoadResource**

WDImageLoadResource, ID, Resource

Example:

```
WImageLoadResource,1,Default\Button\Forward;WImageLoadResource,1,User\User
\DSCN0780.JPG
```

Loads the image with the name "Forward" from the [Image Resource Manager](#)<sup>1249</sup> (Style: Default, Control: Button) to the [Image / Picture Box](#)<sup>930</sup> with ID 1.

The second example shows the command that is needed when sending images with the [WD Remote App](#)<sup>1185</sup>, as these images automatically appear under Style: User, Control: User. If you automatically want to load the last image that was send, the command [WImageLoadRecentResource, ID](#)<sup>1342</sup> could be easier to use.

### ▼ WImageLoadRecentResource

```
WImageLoadRecentResource,ID
```

Example:

```
WImageLoadRecentResource,1
```

Loads the last image that was send from with the [WD Remote App](#)<sup>1185</sup> to the [Image Resource Manager](#)<sup>1249</sup> (Style: User, Control: User) to the [Image / Picture Box](#)<sup>930</sup> with ID 1.

If you like to load other images from the Resource Manager, use the command [WImageLoadResource, ID, Resource](#)<sup>1341</sup>.

### ▼ WImageSaveFile

```
WImageSaveFile,ID,Path
```

Example:

```
WImageSaveFile,1,C:\coolux\content\test.jpg
```

The current image displayed by the [Image / Picture Box](#)<sup>930</sup> with ID 1 is saved with the name "test.jpg" to the path "C:\coolux\content".

### ▼ WImageScreenshot

```
WImageScreenshot,ID
```

Example:

```
WImageScreenshot,1
```

Replaces the content of the image control with the ID 1 with a screenshot from the current desktop.

### ▼ WImageScreenshotRegion

```
WImageScreenshotRegion,ID,X,Y,Width,Height
```

Example:

```
WImageScreenshotRegion,1,100,200,400,300
```

Replaces the content of the image control with the ID 1 with a screenshot of a region from the current desktop. The screenshot regions position starts at pixel 100,200 (X,Y) and is 400 px wide and 300 px high.

### ▼ **WDKeyboardShortcutsEnable**

WDKeyboardShortcutsEnable

Example:

WDKeyboardShortcutsEnable

Enables the use of Keyboard Shortcuts set up in the [Keyboard Shortcut Editor](#)<sup>1204</sup>.

### ▼ **WDKeyboardShortcutsDisable**

WDKeyboardShortcutsDisable

Example:

WDKeyboardShortcutsDisable

Disables the use of Keyboard Shortcuts set up in the [Keyboard Shortcut Editor](#)<sup>1204</sup>.

### ▼ **WDLableText**

WDLableText, ID, Text

Example:

WDLableText, 3, Flip

Changes the text of label 3 to the word Flip, see [Label](#)<sup>931</sup>.

### ▼ **WDLableTextSubString**

WDLableTextSubString, ID, StartIndex, Length

Example:

WDLableTextSubString, 1, 2, 2

Removes any text from Label 1 except those letters that are within the series starting at the second index for the length of 2 positions. Note that the indexing starts with "0" at the first symbol.

Example: Label text = Dewdrop; resulting substring = wd

### ▼ **WDLableTextTrimStart**

WDLableTextTrimStart, ID, Count

Example:

WDLableTextTrimStart, 5, 4

Removes the first 4 characters of the text of label 5 see [Label](#)<sup>931</sup>.

Label 5 before executing the command: "Sequence control".

Label 5 after executing the command: "ence control".

---

**▼ WDLabelTextColour**

WDLabelTextColour,ID,R,G,B

Example:

WDLabelTextColour,3,255,90,0

Changes the colour of Label 3 to orange, see [Label](#)<sup>931</sup>. The values for R,G,B range from 0 to 255.

**▼ WDLabelStartFlash**

WDLabelStartFlash,ID

Example:

WDLabelStartFlash,10

Will start flashing up Label 10, see [Label](#)<sup>931</sup>.

**▼ WDLabelStopFlash**

WDLabelStopFlash,ID

Example:

WDLabelStopFlash,10

Will stop flashing up Label 10, see [Label](#)<sup>931</sup>.

**▼ WDLabelFlashInterval**

WDLabelFlashInterval,ID,Value

Example:

WDLabelFlashInterval,10,2000

Sets the flash interval of Label 10 to 2 seconds (2000 ms), see [Label](#)<sup>931</sup>.

**▼ WDListViewUpdateSource**

WDListViewUpdateSource,ID

Example:

WDListViewUpdateSource,1

Updates the data from the source Excel file of [ListView](#)<sup>932</sup> 1.

**▼ WDListViewResize**

WDListViewResize,ID,ColCount,RowCount

Example:

WDListViewResize,1,5,4



Resizes [ListView](#)<sup>932</sup> 1 to a size of 5 columns and 4 rows.  
Note: All existing data will be deleted when resizing the ListView.

#### ▼ **WDLstViewSetCell**

WDLstViewSetCell, ID, Col, Row, Value

Example:

```
WDLstViewSetCell, 1, 2, 4, hello
```

Sets the value of [ListView](#)<sup>932</sup> 1, row 2, column 4, to "hello".

#### ▼ **WDLstViewNewLine**

WDLstViewNewLine, ID, Col, Value

Example:

```
WDLstViewNewLine, 1, 2, hello
```

Creates a new row beneath all other rows at [ListView](#)<sup>932</sup> 1 and sets the value of column 2 of this new line to "hello".

#### ▼ **WDLstViewSetColumnName**

WDLstViewSetColumnName, ID, Col, Name

Example:

```
WDLstViewSetColumnName, 1, 3, Height
```

Sets the name of [ListView](#)<sup>932</sup> 1 column 3 to "Height".

#### ▼ **WDLstViewLoadCSVFile**

WDLstViewLoadCSVFile, ID, FileName, Separator

Example:

```
WDLstViewLoadCSVFile, 1, C:\coolux\content\measured_data.csv, |
```

Loads the data of the CSV file "measured\_data.csv" into the [ListView](#)<sup>932</sup> 1 and separates the data sets from the CSV file with a "|" (pipe or vertical line) symbol.

Note: You may use any symbol as a separator, except the space " ".

#### ▼ **WDLock**

WDLock

Example:

```
WDLock
```

This locks your WD project window and prevents mouse and keyboard input until it is unlocked again. Alternatively, you can press Ctrl+Pause.

### ▼ **WDUnlock**

WDUnlock

Example:  
WDUnlock

This unlocks your WD project window and allows mouse and keyboard input again. Alternatively, you can press Ctrl+Pause.

### ▼ **WDLockInterface**

WDLockInterface

Example:  
WDLockInterface

This locks your WD project window and opens an onscreen keyboard dialog. Only if the correct password is entered, the interface is unlocked again. You can configure your own password in the [Tools menu](#)<sup>1154</sup> > [Security Settings](#)<sup>1250</sup>. As an alternative to the command you can choose the option Tools > [Lock Interface](#)<sup>1251</sup>.

### ▼ **WDLockGui**

WDLockGui

Example:  
WDLockGui

This command works only when the User Interface protection is activated under [Tools menu](#)<sup>1154</sup> > [Security Settings](#)<sup>1250</sup>. It then protects your WD project window from certain mouse and keyboard inputs. Widget Designer cannot be toggled into Edit Mode anymore, all right-click menus and the Item Properties dialog are not available. To unlock the protection use the command [WDUnlockGui](#)<sup>1346</sup> and enter the password set up. Alternatively, the shortcut Ctrl+Shift+P toggles the Protection Mode.

### ▼ **WDUnlockGui**

WDUnlockGui

Example:  
WDUnlockGui

This toggles the Protection Mode off and allows all mouse and keyboard input again. To enable the Protection mode, use the command [WDLockGui](#)<sup>1346</sup>. Alternatively, the shortcut Ctrl+Shift+P toggles the Protection Mode.

### ▼ **WDMacro**

WDMacro, MacroName

Example:  
WDMacro, Fader Jump

Executes Macro "Fader Jump", if it was created in the [Macro Tool](#)<sup>[1191]</sup> before.

### ▼ **OpenMacroEditor**

OpenMacroEditor

Example:

OpenMacroEditor

Opens the [Macro Editor](#)<sup>[1191]</sup> dialog in WD.

### ▼ **WDMediaPanelSetDevices**

WDMediaPanelSetDevices,PanelID,Devices

Example:

WDMediaPanelSetDevices,3,1.3 1.4 2.5

Connects the Media Panel with the ID 3 in WD to the devices 1,3 and 1,4 and 2,5 in PB, see [Media Control Panel](#)<sup>[889]</sup>.

### ▼ **WDMediaPanelSetFolder**

WDMediaPanelSetFolder,PanelID,Folder

Example:

WDMediaPanelSetFolder,3,004

Loads the thumbnail folder 004 in the Media Panel 3, see [Media Control Panel](#)<sup>[889]</sup>.

Please note, that the file number needs to have 3 digits.

### ▼ **WDMediaPanelSetNextFolder**

WDMediaPanelSetNextFolder,PanelID

Example:

WDMediaPanelSetNextFolder,1

Loads the next thumbnail folder in the Media Panel 1, see [Media Control Panel](#)<sup>[889]</sup>.  
If the folder 002 is the current one, the next one in the list will be loaded.

### ▼ **WDMediaPanelSetPreviousFolder**

WDMediaPanelSetPreviousFolder,PanelID

Example:

WDMediaPanelSetPreviousFolder,1

Loads the previous thumbnail folder in the Media Panel 1, see [Media Control Panel](#)<sup>[889]</sup>.  
If the folder 002 is the current one, the previous one in the list will be loaded.

### ▼ **WDMediaPanelSetIndex**

WDMediaPanelSetIndex,PanelID,Index

Example:

WDMediaPanelSetIndex,3,4

Sets the start index of the files in the Media Panel 3 to 4, see [Media Control Panel](#)<sup>889</sup>.

### ▼ **WDMediaPanelSetLayout**

WDMediaPanelSetLayout,PanelID,Columns,Rows

Example:

WDMediaPanelSetLayout,3,2,6

Changes the layout of Media Panel 3. The thumbnails will be displayed in 2 columns and 6 rows. See [Media Control Panel](#)<sup>889</sup>.

### ▼ **WDMessageBox**

WDMessageBox,Title,Content

Example:

WDMessageBox,Attention!,Please do X before you do Y!

Displays a message box that blocks the UI until the "Ok" button is clicked:

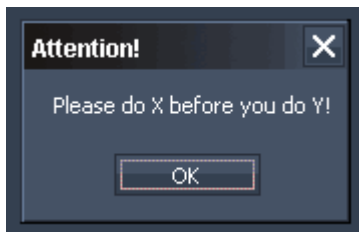

### ▼ **WDMacroBoxOkCancel**

WDMacroBoxOkCancel,Title,Content,MacroName1,MacroName2

Example:

WDMacroBoxOkCancel,Attention!,Do you really want to exit WD?,MacroExit,MacroDoNothing

Pops up a message box with the title "Attention!" and the text "Do you really want to exit WD?". If you click on "OK", the Macro "MacroExit" will be executed, if you click on "Cancel" the Macro "MacroDoNothing" will be executed.

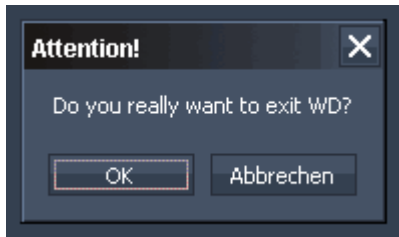

Set up the macros with the [Macro Tool](#)<sup>1191</sup> before.

### ▼ **WDMacroBoxYesNo**

WDMacroBoxYesNo, Title, Content, MacroName1, MacroName2

Example:

WDMacroBoxYesNo, Attention!, Do you really want to exit WD?, MacroExit, MacroDoNothing

Pops up a message box with the title "Attention!" and the text "Do you really want to exit WD?". If you click on "Yes", the Macro "MacroExit" will be executed, if you click on "No" the Macro "MacroDoNothing" will be executed.

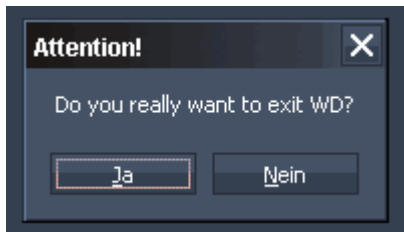

Set up the macros with the [Macro Tool](#)<sup>1191</sup> before.

### ▼ **WDMotionMaskSetScale**

WDMotionMaskSetScale, ID, Value

Example:

WDMotionMaskSetScale, 1, 0.5

Sets the Scale value for the Motion Mask Display 1 to 0.5, see [Motion Mask Display](#)<sup>916</sup>.

### ▼ **WDMotionMaskSetInValue**

WDMotionMaskSetInValue, ID, Value

Example:

WDMotionMaskSetInValue, 1, 0.5

Sets the In-Value for the Motion Mask Display 1 to 0.5, see [Motion Mask Display](#)<sup>916</sup>.

### ▼ **WDMotionMaskSetOutValue**

WDMotionMaskSetOutValue, ID, Value

Example:

WDMotionMaskSetOutValue,1,0.5

Sets the Out-Value for the Motion Mask Display 1 to 0.5, see [Motion Mask Display](#)<sup>916</sup>.

#### ▼ **WDMotionMaskSetThreshold**

WDMotionMaskSetThreshold,ID,Value

Example:

WDMotionMaskSetThreshold,1,4

Sets the Threshold for the Motion Mask Display 1 to the value 4, see [Motion Mask Display](#)<sup>916</sup>.

#### ▼ **WDMotionMaskSetPaintOnly**

WDMotionMaskSetPaintOnly,ID,Bool

Example:

WDMotionMaskSetPaintOnly,1,true

Enables the Paint Only option for the Motion Mask Display 1, see [Motion Mask Display](#)<sup>916</sup>.

#### ▼ **WDMotionMaskClear**

WDMotionMaskClear,ID

Example:

WDMotionMaskClear,1

Clears the Motion Mask Display 1, see [Motion Mask Display](#)<sup>916</sup>.

#### ▼ **WDMotionMaskUseAirScan**

WDMotionMaskUseAirScan,ID

Example:

WDMotionMaskUseAirScan,1

Enables the [AirScan](#)<sup>1155</sup> as input for the Motion Mask Display 1, see [Motion Mask Display](#)<sup>916</sup>.

#### ▼ **WDMotionMaskDoNotUseAirScan**

WDMotionMaskDoNotUseAirScan,ID

Example:

WDMotionMaskDoNotUseAirScan,1

Disables the [AirScan](#)<sup>1155</sup> as input for the Motion Mask Display 1, see [Motion Mask Display](#)<sup>916</sup>.

### ▼ **WDMotionMaskUseCameraPointTracking**

WDMotionMaskUseCameraPointTracking, ID

Example:

WDMotionMaskUseCameraPointTracking, 1

Enables the [Camera Point Tracking](#)<sup>1224</sup> as input for the Motion Mask Display 1, see [Motion Mask Display](#)<sup>916</sup>.

### ▼ **WDMotionMaskDoNotUseCameraPointTracking**

WDMotionMaskDoNotUseCameraPointTracking, ID

Example:

WDMotionMaskDoNotUseCameraPointTracking, 1

Disables the [Camera Point Tracking](#)<sup>1224</sup> as input for the Motion Mask Display 1, see [Motion Mask Display](#)<sup>916</sup>.

### ▼ **WDMotionMaskUseIPhone**

WDMotionMaskUseIPhone, ID

Example:

WDMotionMaskUseIPhone, 1

Enables the [iPhone](#)<sup>1182</sup> as input for the Motion Mask Display 1, see [Motion Mask Display](#)<sup>916</sup>.

### ▼ **WDMotionMaskDoNotUseIPhone**

WDMotionMaskDoNotUseIPhone, ID

Example:

WDMotionMaskDoNotUseIPhone, 1

Disables the [iPhone](#)<sup>1182</sup> as input for the Motion Mask Display 1, see [Motion Mask Display](#)<sup>916</sup>.

### ▼ **WDMotionMaskUseKinect**

WDMotionMaskUseKinect, ID

Example:

WDMotionMaskUseKinect, 1

Enables the [Kinect](#)<sup>1162</sup> as input for the Motion Mask Display 1, see [Motion Mask Display](#)<sup>916</sup>.

### ▼ **WDMotionMaskDoNotUseKinect**

WDMotionMaskDoNotUseKinect, ID

Example:  
WDMotionMaskDoNotUseKinect,1

Disables the [Kinect](#)<sup>1162</sup> as input for the Motion Mask Display 1, see [Motion Mask Display](#)<sup>916</sup>.

### ▼ **WDMultiTouchStoreDefaults**

WDMultiTouchStoreDefaults,ID

Example:  
WDMultiTouchStoreDefaults,1

Stores all current values of the Multitouch Panel 1 as Defaults. To apply these values later on to the Multitouch Panel again, use the command [WDMultiTouchApplyDefaults.ID](#)<sup>1352</sup>. Please note that every Multitouch Panel has it's own default values.

### ▼ **WDMultiTouchApplyDefaults**

WDMultiTouchApplyDefaults,ID

Example:  
WDMultiTouchApplyDefaults,1

Applies the stored default values to the Multitouch Panel 1. To store new default values to the panel please use the command [WDMultiTouchStoreDefaults.ID](#)<sup>1352</sup>. Please note that every Multitouch Panel has it's own default values.

### ▼ **WDMultiTouchClearInputs**

WDMultiTouchClearInputs,ID

Example:  
WDMultiTouchClearInputs,1

In case that the network connection to the AirScan or another Remote input was lost while these devices sent active touch points, the Multitouch Panel ID 1 will be cleared from these hanging touch points by executing this command.

### ▼ **WDMultiTouchSetZoom**

WDMultiTouchSetZoom,ID,Zoomfactor

Example:  
WDMultiTouchSetZoom,1,100

Changes the Zoom in the MultiTouch Panel with the ID 1 to the value 100.

### ▼ **WDMultiTouchSetPan**

WDMultiTouchSetPan,ID,X,Y



Example:

WDMultiTouchSetPan,1,10,5

Changes the Pan in the MultiTouch Panel with the ID 1 to the value X=10 and Y=5.

#### ▼ **WDMultiTouchSetActive**

WDMultiTouchSetActive,ID,ItemID

Example:

WDMultiTouchSetActive,1,3

Enables the Item 3 in the MultiTouch Panel with the ID 1.

#### ▼ **WDMultiTouchSetInActive**

WDMultiTouchSetInActive,ID,ItemID

Example:

WDMultiTouchSetActive,1,4

Disables the Item 4 in the MultiTouch Panel with the ID 1.

#### ▼ **WDMultiTouchSetDevice**

WDMultiTouchSetDevice,ID,ItemID,SiteID,DeviceID

Example:

WDMultiTouchSetDevice,1,3,2,5

Assigns the PB Device 2,5 to the Item 3 in the MultiTouch Panel with the ID 1.

#### ▼ **WDMultiTouchSetPos**

WDMultiTouchSetPos,ID,ItemID,XPos,YPos

Example:

WDMultiTouchSetPos,1,3,25,50

Sets the Item 3 in the MultiTouch Panel with the ID 1 to the Position X=25 and Y=50.

#### ▼ **WDMultiTouchSetRot**

WDMultiTouchSetRot,ID,ItemID,Rot

Example:

WDMultiTouchSetRot,1,3,90

Sets the Item 3 in the MultiTouch Panel with the ID 1 to the rotation value of 90°.

---

**▼ WDMultiTouchSetScale**

WDMultiTouchSetScale, ID, ItemID, Scale

Example:

WDMultiTouchSetScale, 1, 3, 40

Scales the Item 3 in the MultiTouch Panel with the ID 1 to 40%.

**▼ WDMultiTouchEnableZoom**

WDMultiTouchEnableZoom, ID, ItemID

Example:

WDMultiTouchEnableZoom, 1, 2

Enables the Zoom option for Item 2 in the MultiTouch Panel with the ID 1.

**▼ WDMultiTouchDisableZoom**

WDMultiTouchDisableZoom, ID, ItemID

Example:

WDMultiTouchDisableZoom, 1, 2

Disables the Zoom option for Item 2 in the MultiTouch Panel with the ID 1.

**▼ WDMultiTouchEnableDrag**

WDMultiTouchEnableDrag, ID, ItemID

Example:

WDMultiTouchEnableDrag, 1, 2

Enables the Drag option for Item 2 in the MultiTouch Panel with the ID 1.

**▼ WDMultiTouchDisableDrag**

WDMultiTouchDisableDrag, ID, ItemID

Example:

WDMultiTouchDisableDrag, 1, 2

Disables the Drag option for Item 2 in the MultiTouch Panel with the ID 1.

**▼ WDMultiTouchEnablePan**

WDMultiTouchEnablePan, ID, ItemID

Example:

WDMultiTouchEnablePan, 1, 2

---

Enables the Pan option for Item 2 in the MultiTouch Panel with the ID 1.

▼ **WDMultiTouchDisablePan**

WDMultiTouchDisablePan,ID,ItemID

Example:

WDMultiTouchDisablePan,1,2

Disables the Pan option for Item 2 in the MultiTouch Panel with the ID 1.

▼ **WDMultiTouchEnableSize**

WDMultiTouchEnableSize,ID,ItemID

Example:

WDMultiTouchEnableSize,1,2

Enables the Size option for Item 2 in the MultiTouch Panel with the ID 1.

▼ **WDMultiTouchDisableSize**

WDMultiTouchDisableSize,ID,ItemID

Example:

WDMultiTouchDisableSize,1,2

Disables the Size option for Item 2 in the MultiTouch Panel with the ID 1.

▼ **WDMultiTouchEnableRotate**

WDMultiTouchEnableRotate,ID,ItemID

Example:

WDMultiTouchEnableRotate,1,2

Enables the Rotate option for Item 2 in the MultiTouch Panel with the ID 1.

▼ **WDMultiTouchDisableRotate**

WDMultiTouchDisableRotate,ID,ItemID

Example:

WDMultiTouchDisableRotate,1,2

Disables the Rotate option for Item 2 in the MultiTouch Panel with the ID 1.

▼ **WDMultiTouchLayerMode**

WDMultiTouchLayerMode,ID,ItemID,DisplayMode

Example:

WDMultiTouchLayerMode,1,2,16:9

Sets the Layer Mode for Item 2 in the MultiTouch Panel with the ID 1 to the aspect ratio 16:9.

The following aspect ratios can be assigned:

4:3, 16:9, 16:10.

### ▼ **WDMultiTouchDisplayMode**

WDMultiTouchDisplayMode,ID,DisplayMode

Example:

WDMultiTouchDisplayMode,1,16:10

Sets the Display Mode for the MultiTouch Panel with the ID 1 to the aspect ratio 16:10.

The following aspect ratios can be assigned:

4:3, 16:9, 16:10.

### ▼ **WDMultiTouchEnableZorder**

WDMultiTouchEnableZorder,ID

Example:

WDMultiTouchEnableZorder,1

Enables the Z-Order option for the MultiTouch Panel with the ID 1.

### ▼ **WDMultiTouchDisableZorder**

WDMultiTouchDisableZorder,ID

Example:

WDMultiTouchDisableZorder,1

Disables the Z-Order option for the MultiTouch Panel with the ID 1.

### ▼ **WDMultiTouchLinkToMouse**

WDMultiTouchLinkToMouse,ID, ItemID

Example:

WDMultiTouchLinkToMouse,1,4

Links Item 4 of MultiTouch Panel 1 to the mouse (whether Move-Mode is enabled for this item or not), as long as

- a) another item is linked to the mouse,
- b) a non active item is assigned or
- c) a non-existing Item (like "0" ) is linked to the mouse.

### ▼ **WDMultiTouchLinkItemToMouse**

WDMultiTouchLinkItemToMouse,ID

Example:

WDMultiTouchLinkItemToMouse,1

Links the item of MultiTouch Panel 1 to the mouse, that is currently selected by the mouse.

This command e.g.. could be placed as Mouse Down or Mouse Enter script for an item inside the MultiTouch Panel: as soon you clicked on or entered this item, it will follow the mouse (whether Move-Mode is enabled for this item or not).

The link is active as long as

- a) another item is linked to the mouse,
- b) a non active item is assigned or
- c) a non-existing Item (like "0" ) is linked to the mouse.

### ▼ **WDMultiTouchBringToFront**

WDMultiTouchBringToFront,ID,ItemID

Example:

WDMultiTouchBringToFront,1,2

Brings the Multitouch item 2 of Multitouch panel 1 to the front if it is completely or partially covered by another Multitouch item.

### ▼ **WDMultiMouseLinkPlay**

WDMultiMouseLinkPlay,ID

Example:

WDMultiMouseLinkPlay,1

Sets the video mode of the item in MultiTouch Panel 1, that currently is linked to the mouse, to "Play".

### ▼ **WDMultiMouseLinkLoop**

WDMultiMouseLinkLoop,ID

Example:

WDMultiMouseLinkLoop,1

Sets the video mode of the item in MultiTouch Panel 1, that currently is linked to the mouse, to "Loop".

### ▼ **WDMultiMouseLinkPause**

WDMultiMouseLinkPause,ID

Example:

WDMultiMouseLinkPause,1

Sets the video mode of the item in MultiTouch Panel 1, that currently is linked to the mouse, to "Pause".

#### ▼ **WDMultiMouseLinkStop**

WDMultiMouseLinkStop,ID

Example:

WDMultiMouseLinkStop,1

Sets the video mode of the item in MultiTouch Panel 1, that currently is linked to the mouse, to "Stop".

#### ▼ **WDMultiTouchItemPlay**

WDMultiTouchItemPlay,ID,ItemID

Example:

WDMultiTouchItemPlay,1,4

Sets the video mode of item 4 in MultiTouch Panel 1 to "Play".

#### ▼ **WDMultiTouchItemLoop**

WDMultiTouchItemLoop,ID,ItemID

Example:

WDMultiTouchItemLoop,1,4

Sets the video mode of item 4 in MultiTouch Panel 1 to "Loop".

#### ▼ **WDMultiTouchItemPause**

WDMultiTouchItemPause,ID,ItemID

Example:

WDMultiTouchItemPause,1,4

Sets the video mode of item 4 in MultiTouch Panel 1 to "Pause".

#### ▼ **WDMultiTouchItemStop**

WDMultiTouchItemPause,ID,ItemID

Example:

WDMultiTouchItemStop,1,4

Sets the video mode of item 4 in MultiTouch Panel 1 to "Stop".

---

**▼ WDMultiTouchRefresh**

WDMultiTouchRefresh,ID

Example:

WDMultiTouchRefresh,1

Refreshes the values of MultiTouch Panel 1 to Pandoras Box.

**▼ WDMultiTouchEnableMouse**

WDMultiTouchEnableMouse,ID

Example:

WDMultiTouchEnableMouse,1

Enables the Mouse for MultiTouch Panel 1.

**▼ WDMultiTouchDisableMouse**

WDMultiTouchDisableMouse,ID

Example:

WDMultiTouchDisableMouse,1

Disables the Mouse for MultiTouch Panel 1.

**▼ WDMultiTouchEnableGestures**

WDMultiTouchEnableGestures,ID

Example:

WDMultiTouchEnableGestures,1

Enables Gestures for Synaptics Touch Pads and Wacom Bamboo Devices for MultiTouch Panel 1.

**▼ WDMultiTouchDisableGestures**

WDMultiTouchDisableGestures,ID

Example:

WDMultiTouchDisableGestures,1

Disables Gestures for Synaptics Touch Pads and Wacom Bamboo Devices for MultiTouch Panel 1.

**▼ WDMultiTouchEnableTouch**

WDMultiTouchEnableTouch,ID

Example:

WDMultiTouchEnableTouch,1

---

Enables Touch for MultiTouch Panel 1.

▼ **WDMultiTouchDisableTouch**

WDMultiTouchDisableTouch,ID

Example:

WDMultiTouchDisableTouch,1

Disables Touch for MultiTouch Panel 1.

▼ **WDMultiTouchEnableAirScan**

WDMultiTouchEnableAirScan

Example:

WDMultiTouchEnableAirScan

Enables the AirScan for MultiTouch Panel 1.

▼ **WDMultiTouchDisableAirScan**

WDMultiTouchDisableAirScan

Example:

WDMultiTouchDisableAirScan

Disables the AirScan for MultiTouch Panel 1.

▼ **WDMultiTouchEnableKinect**

WDMultiTouchEnableKinect

Example:

WDMultiTouchEnableKinect

Enables the Kinect for MultiTouch Panel 1.

▼ **WDMultiTouchDisableKinect**

WDMultiTouchDisableKinect

Example:

WDMultiTouchDisableKinect

Disables the Kinect for MultiTouch Panel 1.

▼ **WDMultiTouchEnableCamera**

WDMultiTouchEnableCamera



Example:

WDMultiTouchEnableCamera

Enables the Camera Tool for MultiTouch Panel 1.

#### ▼ **WDMultiTouchDisableCamera**

WDMultiTouchDisableCamera

Example:

WDMultiTouchDisableCamera

Disables the Camera Tool for MultiTouch Panel 1.

#### ▼ **WDMultiTouchEnableIPhone**

WDMultiTouchEnableIPhone

Example:

WDMultiTouchEnableIPhone

Enables the iPhone for MultiTouch Panel 1.

#### ▼ **WDMultiTouchDisableIPhone**

WDMultiTouchDisableIPhone

Example:

WDMultiTouchDisableIPhone

Disables the iPhone for MultiTouch Panel 1.

#### ▼ **WDNBSBroadcastEnable**

WDNBSBroadcastEnable

Example:

WDNBSBroadcastEnable

Enables the Network Broadcast Service (NBS) for [Faders](#)<sup>925</sup>, [Labels](#)<sup>931</sup> and [Custom Script Buttons](#)<sup>884</sup>.

#### ▼ **WDNBSBroadcastDisable**

WDNBSBroadcastDisable

Example:

WDNBSBroadcastDisable

Disables the Network Broadcast Service (NBS) for [Faders](#)<sup>925</sup>, [Labels](#)<sup>931</sup> and [Custom Script Buttons](#)<sup>884</sup>.

### ▼ **WDNBSReceiveEnable**

WDNBSReceiveEnable

Example:

WDNBSReceiveEnable

Enables [Faders](#)<sup>925</sup>, [Labels](#)<sup>931</sup> and [Custom Script Buttons](#)<sup>884</sup> to receive values via Network Broadcast Service from other controls.

### ▼ **WDNBSReceiveDisable**

WDNBSReceiveDisable

Example:

WDNBSReceiveDisable

Disables [Faders](#)<sup>925</sup>, [Labels](#)<sup>931</sup> and [Custom Script Buttons](#)<sup>884</sup> to receive values via Network Broadcast Service from other controls.

### ▼ **WDNodesEnable**

WDNodesEnable

Example:

WDNodesEnable

Enables all nodes in WD if disabled before and re-establishes their connection to other nodes and outputs.

### ▼ **WDNodesDisable**

WDNodesDisable

Example:

WDNodesDisable

Disables all nodes and releases their connection to other nodes and outputs in WD.

### ▼ **WDNodeEnableOutput**

WDNodeEnableOutput,ID

Example:

WDNodeEnableOutput,35

Enables Output node 36 (for example an Output Node like a Fader Output).

### ▼ **WDNodeDisableOutput**

WDNodeDisableOutput,ID

---

Example:  
WDNodeDisableOutput,35

Disables Output node 36 (for example an Output Node like a Fader Output).

#### ▼ **WDNodeEnableOutputAll**

WDNodeEnableOutputAll

Example:  
WDNodeEnableOutputAll

Disables all Output Nodes.

#### ▼ **WDNodeDisableOutputAll**

WDNodeDisableOutputAll

Example:  
WDNodeDisableOutputAll

Enables all Output Nodes.

#### ▼ **WDNodeConnect**

WDNodeConnect,SourceNodeID,TargetNodeID

Example:  
WDNodeConnect,2,5

Connects the Source Node with the ID 2 to the Target Node with the ID 5.

#### ▼ **WDNodeDisconnect**

WDNodeDisconnect,NodeID,SourceNodeID

Example:  
WDNodeDisconnect,3,2

Disconnects the Node with the ID 3 from the Source Node with the ID 2.

#### ▼ **WDNodeSetParam**

WDNodeSetParam,NodeID,ParamID,Value

Example:  
WDNodeSetParam,12,3,32

Sets Parameter 3 of Node 12 to the value 32, for example if Node 12 is a Range filter node, the Input Max will be changed to 32, see Picture below.

All parameters with a small number behind can be changed with this command.

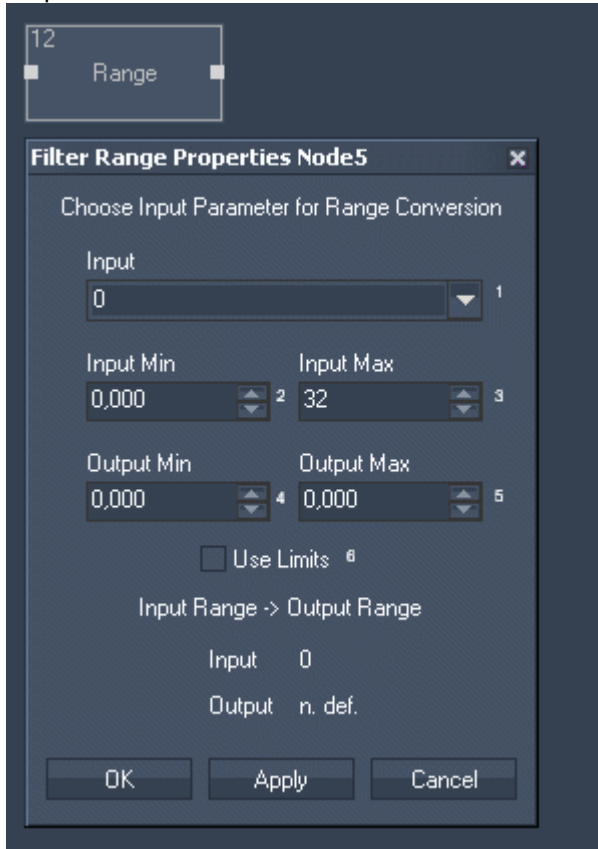

Rev 668 and higher support [Node Commands](#)<sup>977</sup> in a more direct form. The above command can be replaced with the more direct command `NodeID.ParamID@Value`. With the numbers from the example, that would be: `Node12.3@32`

▼ **WDNodeSetParam+=**

`WDNodeSetParam+=,NodeID,ParamID,Value`

Example:

`WDNodeSetParam+=,3,1,10`

Adds the value 10 to parameter 1 of Node 3, for example if Node 3 is a Value Input Node, its Output value will be increased by 10.

▼ **WDNodeSetParam-=**

`WDNodeSetParam-=,NodeID,ParamID,Value`

Example:

`WDNodeSetParam-=,3,1,10`

Subtracts the value 10 from parameter 1 of Node 3, for example if Node 3 is a Value Input Node, its Output value will be decreased by 10.

### ▼ **WDNodeSetParam\*= WDNodeSetParam\*=**

WDNodeSetParam\*=,NodeID,ParamID,Value

Example:

WDNodeSetParam\*=,3,1,10

Multiplies the value parameter 1 of Node 3 with the factor 10, for example if Node 3 is a Value Input Node, its Output value will be multiplied by 10.

### ▼ **WDNodeSetParam/=**

WDNodeSetParam/=,NodeID,ParamID,Value

Example:

WDNodeSetParam/=,3,1,10

Divides the value of parameter 1 of Node 3 through 10, for example if Node 3 is a Value Input Node, its Output value will be divided through 10.

### ▼ **WDNodeSetParamFromNodeInputValue**

WDNodeSetParamFromNodeInputValue,NodeID,ParamID,SourceNodeID,SourceNodeInParamID

Example:

WDNodeSetParamFromNodeInputValue,7,2,6,1

Sets the parameter 2 of Node 7 to the input value of parameter 1 of Node 6.

Allows to combine the current values of Nodes by ID

### ▼ **WDNodeSetParamFromNodeOutputValue**

WDNodeSetParamFromNodeOutputValue,NodeID,ParamID,SourceNodeID,SourceNodeOutParamID

Example:

WDNodeSetParamFromNodeOutputValue,7,2,6,1

Sets the parameter 2 of Node 7 to the output value of parameter 1 of Node 6.

Allows to combine the current values of Nodes by ID

### ▼ **WDNodeSetParamFromNode+=**

WDNodeSetParamFromNode+=,NodeID,ParamID,SourceNodeID,SourceNodeParamID

Example:

WDNodeSetParamFromNode+=,4,1,2,3

Adds the value of parameter 3 of Node 2 to the value of parameter 1 of Node 4.

This way node values can be dynamically changed via commands to any number, without causing infinite loops.

### ▼ **WDNodeSetParamFromNode-=**

WDNodeSetParamFromNode=,NodeID,ParamID,SourceNodeID,SourceNodeParamID

Example:

WDNodeSetParamFromNode=,4,1,2,3

Subtracts the value of parameter 3 of Node 2 from the value of parameter 1 of Node 4.

This way node values can be dynamically changed via commands to any number, without causing infinite loops.

### ▼ **WDNodeSetParamFromNode\*=-**

WDNodeSetParamFromNode\*=-,NodeID,ParamID,SourceNodeID,SourceNodeParamID

Example:

WDNodeSetParamFromNode\*=-,4,1,2,3

Multiplies the value of parameter 1 of Node 4 with the value of parameter 3 of Node 2.

### ▼ **WDNodeSetParamFromNode/=**

WDNodeSetParamFromNode/=,NodeID,ParamID,SourceNodeID,SourceNodeParamID

Example:

WDNodeSetParamFromNode/=,4,1,2,3

Divides the value of parameter 1 of Node 4 through the value of parameter 3 of Node 2.

This way node values can be dynamically changed via commands to any number, without causing infinite loops.

### ▼ **WDNodeSetParamSource**

WDNodeSetParamSource,NodeID,ParamID,SourceNodeID,SourceNodeParamID

Example:

WDNodeSetParamSource,7,1,6,2

Changes the source for the input parameter if two or more nodes or a single one with several values is connected to a filter or output node.

In this example the input parameter (1) of the Add node (7) will change to the value for Y Position (2) of the Mouse Input node (6).

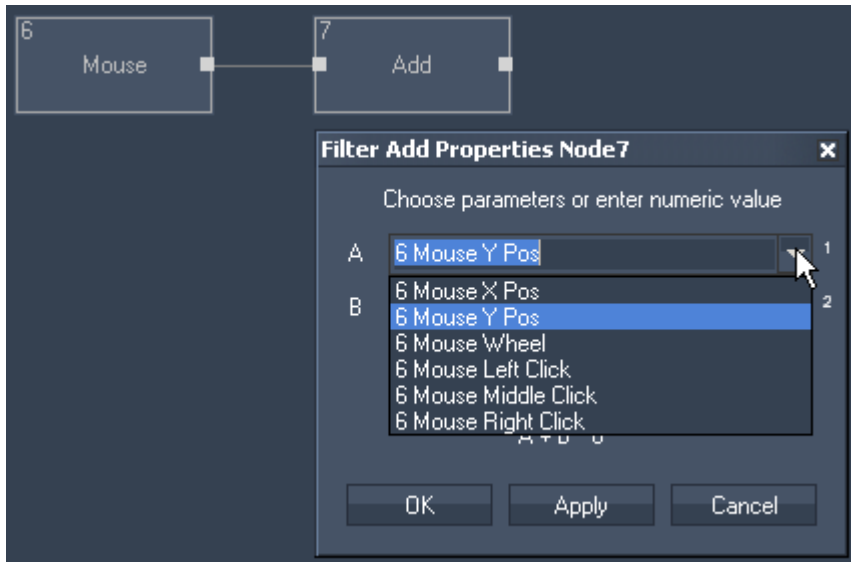

Rev 668 and higher support [Node Commands](#)<sup>977</sup> in a more direct form. The above command can be replaced with the more direct command `NodeID.ParamID&NodeID,ParamID`. With the numbers from the example, that would be: `Node7.1&6.2`

▼ **WDNodeSetOutput**

`WDNodeSetOutput,NodeID,ParamID,Value`

Example:

`WDNodeSetOutput,2,1,100`

Sets the first output parameter of Input Node 2 to the value 100.

This command allows to set an output parameter of an Input Node to a specific value (applies to TCP, UDP and COM ASCII String / Stream Input Nodes)

▼ **WDNodeProcessOutput**

`WDNodeProcessOutput,NodeID`

Example:

`WDNodeProcessOutput,12`

Per default all output nodes update their value according to the [Node Cycle Interval](#)<sup>1252</sup> (Tools > Options). This means their entire preceding node chain is run through starting with the input node and passing all possible filter nodes. With this command, output node 12 updates its value (once and independent from the set Node Cycle Interval) by pulling new data from its preceding node chain and sending it to the according output control or connection.

▼ **WDNodeRefreshOutput**

`WDNodeRefreshOutput,NodeID`

Example:

`WDNodeRefreshOutput,12`

Per default all output nodes update their value according to the [Node Cycle Interval](#) <sup>1252</sup>(Tools > Options). This means their entire preceding node chain is run through starting with the input node and passing all possible filter nodes. With this command, output node 12 sends its current value (once and independent from the set Node Cycle Interval) to the according output control or connection. However, it does not pull new data from its preceding node chain, this happens with the next Node Cycle.

Please note:

This command is only valid for the output nodes for a Label, Fader, Bargraph, AngularDisplay, DigitalDisplay. In addition the Script Output Node can be refreshed which executes (depending on the input data) the True or False Script.

### ▼ **WDNodeCommand**

WDNodeCommand,NodeID,Args0,ArgsN

Example:

WDNodeCommand,1,PowerOn

Executes a "Power On" command at the Projector Control Node ID 1, please refer to the topic [Node Commands](#) <sup>977</sup> for further information.

### ▼ **WDOpacity**

WDOpacity,Value 0-1

Example:

WDOpacity,0.5

Displays the entire Widget Designer window as a see-through (transparent) window. Insert values between 0 and 1, with 0 being completely transparent and 1 being completely opaque.

### ▼ **WDTransparencyKey**

WDTransparencyKey,R,G,B

Example:

WDTransparencyKey,255,255,255

Sets the Transparency Key to white (Red:255, Green:255, Blue:255) and displays all pixels with this color as see-through (transparent) areas. Note that this effects the entire Widget Designer window. The command `WDTransparencyKeyOff` deactivates this feature again.

### ▼ **WDTransparencyKeyOff**

WDTransparencyKeyOff

Example:

WDTransparencyKeyOff

This deactivates the Transparency Key, when used before with the command `WDTransparencyKey`.



---

### ▼ **WDPageGoto**

WDPageGoto, Pagename

Example:  
WDPageGoto, faders

Changes to page "faders" if the page "faders" was created before.

### ▼ **WDPageGotoSilent**

WDPageGotoSilent, Pagename

Example:  
WDPageGotoSilent, faders

Changes to page "faders" without executing its page enter script.

### ▼ **WDPageExecuteEnterScript**

WDPageExecuteEnterScript, Pagename

Example:  
WDPageExecuteEnterScript, Settings2

Executes the On Page Enter Script of the page named "Settings2", see [Page](#)<sup>880</sup>.

### ▼ **WDPageExecuteLeaveScript**

WDPageExecuteLeaveScript, Pagename

Example:  
WDPageExecuteLeaveScript, Settings2

Executes the On Page Leave Script of the page named "Settings2", see [Page](#)<sup>880</sup>.

### ▼ **WDPageNext**

WDPageNext

Example:  
WDPageNext

Goes to the next page in order. If this command is called when being on the last page, the first one will be called.

### ▼ **WDPageLast**

WDPageLast

---

Example:  
WDPageLast

Goes to the last page in order. If this command is called when being on the first page, the last one will be called.

### ▼ **WDPageForward**

WDPageForward

Example:  
WDPageForward

Calls up the next page in history.

### ▼ **WDPagePrevious**

WDPagePrevious

Example:  
WDPagePrevious

Calls up the last page in history.

### ▼ **WDPageClearHistory**

WDPageClearHistory

Example:  
WDPageClearHistory

Clears the history, so that "WDPageForward" and "WDPagePrevious" do not call up another page different than the "Default" one.

### ▼ **WDPagePrintWithDialog**

WDPagePrintWithDialog

Example:  
WDPagePrintWithDialog

To print the current WD GUI this command opens the Windows Print-Dialog where you can to choose and setup the printer.

### ▼ **WDPagePrint**

WDPagePrint

Example:  
WDPagePrint

---

Choose this command to print the current WD GUI without opening the Windows Print-Dialog where you can to choose and setup the printer.

#### ▼ **WDPagePrintGrayWithDialog**

WDPagePrintGrayWithDialog

Example:

WDPagePrintGrayWithDialog

This command prints the current WD GUI in gray scale. The Windows Print-Dialog opens where you can choose and setup the printer.

#### ▼ **WDPagePrintGray**

WDPagePrintGray

Example:

WDPagePrintGray

This command prints the current WD GUI in gray scale.

#### ▼ **WDPagePrintInvertWithDialog**

WDPagePrintInvertWithDialog

Example:

WDPagePrintInvertWithDialog

This command prints the current WD GUI in inverted colors. The Windows Print-Dialog opens where you can choose and setup the printer.

#### ▼ **WDPagePrintInvert**

WDPagePrintInvert

Example:

WDPagePrintInvert

This command prints the current WD GUI in inverted colors.

#### ▼ **WDPagePrintGrayInvertWithDialog**

WDPagePrintGrayInvertWithDialog

Example:

WDPagePrintGrayInvertWithDialog

This command prints the current WD GUI in inverted gray scale. The Windows Print-Dialog opens where you can choose and setup the printer.

---

### ▼ **WDPagePrintGrayInvert**

WDPagePrintGrayInvert

Example:

WDPagePrintGrayInvert

This command prints the current WD GUI in inverted gray scale.

### ▼ **WDPasswordDialog**

WDPasswordDialog,Password

Example:

WDPasswordDialog,Coolux

This command opens a Password Dialog, passwords can only be entered using the displayed keyboard. In case the password is incorrect the script will not continue. If Coolux is typed in correctly, the following commands will be executed.

This is useful to lock access to specific Pages or Commands.

### ▼ **WDPictureBoxFile**

WDPictureBoxFile,ID,File

Example:

WDPictureBoxFile,1,C:\coolux\content\test1.jpg

Replaces the content of the PictureBox control with the ID 1 with the image "test1.jpg" from the path C:\coolux\content.

### ▶ **WDPictureBoxScreenshot**

WDPictureBoxScreenshot,ID

Example:

WDPictureBoxScreenshot,1

Replaces the content of the PictureBox control with the ID 1 with a screenshot from the current desktop.

### ▼ **WDPictureBoxScreenshotRegion**

WDPictureBoxScreenshotRegion,ID,X,Y,Width,Height

Example:

WDPictureBoxScreenshotRegion,1,100,200,400,300

Replaces the content of the PictureBox control with the ID 1 with a screenshot of a region from the current desktop. The screenshot regions position starts at pixel 100,200 (X,Y) and is 400 px wide and 300 px high.

---

**▼ WDRemoteTCPEnable**

WDRemoteTCPEnable

Example:

WDRemoteTCPEnable

Enables the TCP connection set up via the [Remoting Tool](#)<sup>1182</sup>.

**▼ WDRemoteTCPDisable**

WDRemoteTCPDisable

Example:

WDRemoteTCPDisable

Disables the TCP connection set up via the [Remoting Tool](#)<sup>1182</sup>.

**▼ WDRemoteUDPEnable**

WDRemoteUDPEnable

Example:

WDRemoteUDPEnable

Enables the UDP connection set up via the [Remoting Tool](#)<sup>1182</sup>.

**▼ WDRemoteUDPDisable**

WDRemoteUDPDisable

Example:

WDRemoteUDPDisable

Disables the UDP connection set up via the [Remoting Tool](#)<sup>1182</sup>.

**▼ WDRemoteHTTPEnable**

WDRemoteHTTPEnable

Example:

WDRemoteHTTPEnable

Enables the HTTP Listener set up via the [Remoting Tool](#)<sup>1182</sup>.

**▼ WDRemoteHTTPDisable**

WDRemoteHTTPDisable

Example:

WDRemoteHTTPDisable

---

Disables the HTTP Listener set up via the [Remoting Tool](#)<sup>1182</sup>.

#### ▼ **WDRemoteCOMEnable**

WDRemoteCOMEnable

Example:

WDRemoteCOMEnable

Enables the COM Port connection set up via the [Remoting Tool](#)<sup>1182</sup>.

#### ▼ **WDRemoteCOMDisable**

WDRemoteCOMDisable

Example:

WDRemoteCOMDisable

Disables the COM Port connection set up via the [Remoting Tool](#)<sup>1182</sup>.

#### ▼ **WDScreenshot**

WDScreenshot,FileName

Example:

WDScreenshot,C:\coolux\screenshots\Page1

Creates a screenshot of the current WD user interface and save it as Page1.png under the path C:\coolux\screenshots.

If you don't specify the file path with this command, the screenshot will be saved as Page1.png in the root folder of your WD project.

#### ▼ **WDScreenshotWithTime**

WDScreenshotWithTime,FileName

Example:

WDScreenshotWithTime,C:\coolux\screenshots\Page1

Creates a screenshot of the current WD user interface and save it e.g. as Page1\_31\_05\_2011-16\_43\_22.png under the path C:\coolux\screenshots.

If you don't specify the file path with this command, the screenshot will be saved in the root folder of your WD project.

#### ▼ **WDScreenshotDialog**

WDScreenshotDialog

Example:

WDScreenshotDialog

Creates a screenshot of the current WD user interface and opens the Save As Dialog, where you can choose the location you want the screenshot to be saved and its name. It allows you to choose the file type of your screenshot as well (Bitmap, Jpeg or PNG).

### ▼ **WDScreenshotRegion**

WDScreenshotRegion,X,Y,Width,Height,FileName

Example:

```
WDScreenshotRegion,1,1,400,300,C:\coolux\screenshots\Test1
```

Creates a screenshot that is 400px wide and 300 px high, starting at pixel X=1 and Y=1 of the current screen and saves it as Test1.png under the path C:\coolux\screenshots.

If you don't specify the file path with this command, the screenshot will be saved in the root folder of your WD project.

### ▼ **WDScreenshotRegionWithTime**

WDScreenshotRegionWithTime,X,Y,Width,Height,FileName

Example:

```
WDScreenshotRegionWithTime,1,1,400,300,C:\coolux\screenshots\Test1
```

Creates a screenshot that is 400px wide and 300 px high, starting at pixel X=1 and Y=1 of the current screen and saves it as e.g. Test1\_31\_05\_2011-16\_43\_22.png under the path C:\coolux\screenshots.

If you don't specify the file path with this command, the screenshot will be saved in the root folder of your WD project.

### ▼ **WDScreenshotRegionDialog**

WDScreenshotRegionDialog,X,Y,Width,Height

Example:

```
WDScreenshotRegionDialog,1,1,400,300
```

Creates a screenshot that is 400px wide and 300 px high, starting at pixel X=1 and Y=1 of the current screen and opens the Save As Dialog, where you can choose the location you want the screenshot to be saved and its name. It allows you to choose the file type of your screenshot as well (Bitmap, Jpeg or PNG).

### ▼ **WDScriptTimerStart**

WDScriptTimerStart,ID

Example:

```
WDScriptTimerStart,1
```

Starts the Script Timer with the ID 1. It will keep on running until it is stopped via a command or via a click on it with the mouse (when it is set to run continuously).

---

**▼ WDScriptTimerStop**

WDScriptTimerStop,ID

Example:

WDScriptTimerStop,1

Stops the Script Timer with the ID 1.

**▼ WDScriptTimerInterval**

WDScriptTimerInterval,ID,Value

Example:

WDScriptTimerInterval,1,5000

Changes the Interval Time of the Script Timer with the ID 1 to 5000 ms.

**▼ WDScriptTimerRunOnce**

WDScriptTimerRunOnce,ID

Example:

WDScriptTimerRunOnce,1

Changes the mode of the Script Timer with the ID 1 to run only once.

**▼ WDScriptTimerRunContinuous**

WDScriptTimerRunContinuous,ID

Example:

WDScriptTimerRunContinuous,1

Changes the mode of the Script Timer with the ID 1 to run continuously.

**▼ WDScrollerReset**

WDScrollerReset,ID

Example:

WDScrollerReset,1

Resets Scroller 1 by bringing the first Item to the first position. See [Scroller Control](#)<sup>901</sup>.

**▼ WDTtextboxClear**

WDTtextboxClear,TXTBoxID

Example:

WDTtextboxClear,1



---

Clears all text from the Text Box 1, see [Textbox](#)<sup>953</sup>.

#### ▼ **WDTextboxAddTextFromLabel**

WDTextboxAddTextFromLabel, TXTBoxID, LabelID

Example:

WDTextboxAddTextFromLabel, 1, 3

Adds the text from Label 3 to the text of Textbox 1, see [Textbox](#)<sup>953</sup>.

#### ▼ **WDTextboxAddTextFromTextbox**

WDTextboxAddTextFromTextbox, TXTBoxID, TXTBoxSourceID

Example:

WDTextboxAddTextFromTextbox, 1, 3

Adds the text from Textbox 3 to the text of Textbox 1, see [Textbox](#)<sup>953</sup>.

#### ▼ **WDTextboxAddTextFromRSSFeed**

WDTextboxAddTextFromRSSFeed, TXTBoxID, RSSFeedID

Example:

WDTextboxAddTextFromRSSFeed, 2, 26

This adds the [RSS Feed](#)<sup>1217</sup> including its title and body with ID 26 to the [Textbox](#)<sup>953</sup> with ID 2.

#### ▼ **WDTextboxAddTextFromRSSFeedTitle**

WDTextboxAddTextFromRSSFeedTitle, TXTBoxID, RSSFeedID

Example:

WDTextboxAddTextFromRSSFeedTitle, 2, 26

This adds the [RSS Feed](#)<sup>1217</sup> title with ID 26 to the [Textbox](#)<sup>953</sup> with ID 2.

#### ▼ **WDTextboxAddTextFromRSSFeedBody**

WDTextboxAddTextFromRSSFeedBody, TXTBoxID, RSSFeedID

Example:

WDTextboxAddTextFromRSSFeedBody, 2, 26

This adds the [RSS Feed](#)<sup>1217</sup> body content with ID 26 to the [Textbox](#)<sup>953</sup> with ID 2.

#### ▼ **WDTextboxAddTextFromSMS**

WDTextboxAddTextFromSMS, TXTBoxID, SMSID

Example:

WDTextboxAddTextFromSMS,2,26

This adds the [SMS message](#)<sup>1219</sup> with ID 26 to the [Textbox](#)<sup>953</sup> with ID 2.

#### ▼ **WDTextboxAddTextFromLastSMS**

WDTextboxAddTextFromLastSMS,XTBoxID

Example:

WDTextboxAddTextFromLastSMS,XTBoxID

This adds the penultimate incoming SMS message to the [Textbox](#)<sup>953</sup> with ID 2.

#### ▼ **WDTextboxAppend**

WDTextboxAppend,ID,Value

Example:

WDTextboxAppend,1,Hello

Adds the text "Hello" to the [Textbox](#)<sup>953</sup> 1. If there is a variable with the name "Hello", its value will be appended to the textbox instead.

This way you may compose a script inside a textbox that can be executed via the command [WDTextboxExecuteAsScript,ID](#)<sup>1379</sup>.

#### ▼ **WDTextboxAppendTextOnly**

WDTextboxAppendTextOnly,ID,Text

Example:

WDTextboxAppendTextOnly,1,Hello

Adds the text "Hello" to the [Textbox](#)<sup>953</sup> 1. If there is a variable with the name "Hello", still the string "Hello" is appended and not the variables value.

This way you may compose a script inside a textbox that can be executed via the command [WDTextboxExecuteAsScript,ID](#)<sup>1379</sup>.

#### ▼ **WDTextboxFocus**

WDTextboxFocus,ID

Example:

WDTextboxFocus,3

This sets the [Textbox](#)<sup>953</sup> with ID 3 into the focus, meaning that the next keyboard input will be added to this Textbox.

▼ **WDTextboxRefresh**

WDTextboxRefresh, ID

Example:

WDTextboxRefresh, 1

Updates the text of Textbox 1. This is useful when the [Textbox Input Node](#)<sup>1056</sup> is used and the Textbox ID inside the node is changed via a command, see [Textbox](#)<sup>953</sup>.

▼ **WDTextboxNewline**

WDTextboxNewline, ID

Example:

WDTextboxNewline, 1

Starts a new line in the Textbox 1, see [Textbox](#)<sup>953</sup>.

This way you may compose a script list inside a textbox that can be executed via the command [WDTextboxExecuteAsScript.ID](#)<sup>1379</sup>.

▼ **WDTextboxExecuteAsScript**

WDTextboxExecuteAsScript, ID

Example:

WDTextboxExecuteAsScript, ID

Executes the text in Textbox 1 as a command, see [Textbox](#)<sup>953</sup>. You may use the command [WDTextboxAppend](#)<sup>1378</sup> to compose the script from single parts.

▼ **WDTextboxReplaceLineEnd**

WDTextboxReplaceLineEnd, ID, Text

Example:

WDTextboxReplaceLineEnd, 1, FLIP

This replaces each end of a line in [Textbox](#)<sup>953</sup> with ID 1 with the word "FLIP".

First Line

Second Line

Third Line

becomes: first lineFLIPsecond lineFLIPthird line

▼ **WDTextboxTrimEndToTotalCount**

WDTextboxTrimEndToTotalCount, ID, Count

Example:

WDTextboxTrimEndToTotalCount, 1, 8

This removes all characters from Textbox with ID 1 except for the first 8 characters.

### ▼ **WDTextboxToFile**

WDTextboxToFile, ID, Filename

Example:

WDTextboxToFile, 3, C:\coolux\content\Test.txt

This copies the text content from the Widget Designer [Textbox](#)<sup>953</sup> with ID 3 and overwrites all text in the text file saved under the following path: C:\coolux\content\Test.txt.

### ▼ **WDTextboxAppendToFile**

WDTextboxAppendToFile, ID, Filename

Example:

WDTextboxAppendToFile, 3, C:\coolux\content\Test.txt

This copies the text content from the Widget Designer [Textbox](#)<sup>953</sup> with ID 3 and appends it to the text from the file saved under the following path: C:\coolux\content\Test.txt.

### ▼ **WDTextboxFromFile**

WDTextboxFromFile, ID, Filename

Example:

WDTextboxFromFile, 3, C:\coolux\content\Test.txt

This copies the content from the text file saved under C:\coolux\content\Test.txt and overwrites the text in the Widget Designer [Textbox](#)<sup>953</sup> with ID 3.

### ▼ **WDTextboxAppendFromFile**

WDTextboxAppendFromFile, ID, Filename

Example:

WDTextboxAppendFromFile, 3, C:\coolux\content\Test.txt

This copies the content from the text file saved under C:\coolux\content\Test.txt and appends it to the text in the Widget Designer [Textbox](#)<sup>953</sup> with ID 3.

### ▼ **WDTextboxConvertToHorizontalScrolltextPNG**

WDTextboxConvertToHorizontalScrolltextPNG, ID, File, Red, Green, Blue, Alpha

Example:

WDTextboxConvertToHorizontalScrolltextPNG, 3, C:\coolux\content\blue.png, 0, 0, 170, 255

First, this command converts the text of [Textbox](#)<sup>953</sup> with ID 3 to a horizontal scrolltext, meaning that all line ends are deleted. Then it saves the text as an image file to the following path C:\coolux

`\content\blue.png`. The image size, text color and other font properties accord to the Textbox font settings in Widget Designer whilst the image background color is set with the command. In the example, the color 0,0,170,255 is chosen for RGBA, resulting in a fully opaque blue background.

### ▼ **WDTtextboxConvertToPNG**

WDTtextboxConvertToPNG,ID,File

Example:

WDTtextboxConvertToPNG,3,C:\coolux\content\text.png

This command saves the text of [Textbox](#)<sup>953</sup> with ID 3 including all line ends as an image file to the following path `C:\coolux\content\text.png`. The image size matches the Textbox size and the text color and other font properties accord to the Textbox font settings in Widget Designer. The image background color is always black.

### ▼ **WDTtextConvertToHorizontalScrollTextPNG**

WDTtextConvertToHorizontalScrollTextPNG,Text(),Font(),File,Red,Green,Blue,Alpha

Example:

WDTtextConvertToHorizontalScrollTextPNG>Hello,Mistral/12/Bold/170/255/170/170,c:\coolux\content\text.png,0,0,170,255

This command saves the text "Hello" as an image file to the following path `C:\coolux\content\customtext.png`. The text font is set to "Mistral", the text size to 12pt, the text style to "Bold" and the text color to 170,0,170,170 for RGBA. The image background color is set to 0,0,170,255 for RGBA, resulting in a fully opaque blue background.

Font syntax: Name/Size/Style/R/G/B/A

Style options: Regular,Bold,Italic,Underline or Strikeout

### ▼ **WDTtextConvertToQRCodePNG**

WDTtextConvertToQRCodePNG,File,Text

Example:

WDTtextConvertToQRCodePNG,C:\coolux\content\qr\_bw.png,Widget Designer

This command converts the text "Widget Designer" to a QR code. The black and white QR code is saved as an image file to the following path `C:\coolux\content\qr_bw.png`.

### ▼ **WDTtextConvertToColoredQRCodePNG**

WDTtextConvertToColoredQRCodePNG,Size,R,G,B,A,R,G,B,A,File,Text

Example:

WDTtextConvertToColoredQRCodePNG,5,150,0,255,255,0,255,0,120,C:\coolux\content\qr\_col.png,Hello

This command converts the text "Hello" to a colored QR code. The QR code size 5 results in an image width and height of 189px, see below. The foreground color is set to 150,0,255,255 for RGBA (a fully opaque purple) and the background to 0,255,0,120, a half transparent green.

The size 0 results in an 1px large image. Every further step adds 47px. Hence, a size of 5 results in 189px as  $1\text{px} + 4 \cdot 47\text{px} = 189\text{px}$ .

### ▼ **WDTextInputClear**

WDTextInputClear,ID

Example:  
WDTextInputClear,1

Clears all text from the Text Input 1, see [Text Input](#)<sup>951</sup>.

### ▼ **WDTextInputReset**

WDTextInputReset,ID

Example:  
WDTextInputReset,1

Sets the Text Input to the first available line, see [Text Input](#)<sup>951</sup>.

### ▼ **WDTextInputNext**

WDTextInputNext,ID

Example:  
WDTextInputNext,1

Sets the Text Input to the next available line, see [Text Input](#)<sup>951</sup>.

### ▼ **WDTextInputLast**

WDTextInputLast,ID

Example:  
WDTextInputLast,1

Sets the Text Input to the last available line, see [Text Input](#)<sup>951</sup>.

### ▼ **WDTextInputGotoLine**

WDTextInputGotoLine,ID,SourceID

Example:  
WDTextInputGotoLine,1,2

Jumps to the line number in Text Input 1, that is taken from the numeric entry in [Textbox](#)<sup>953</sup> 2, see [Text Input](#)<sup>951</sup>.

---

**▼ WDTextInputUpdate**

WDTextInputUpdate,ID

Example:

WDTextInputUpdate,1

Updates the current line in Text Input 1 (no effect when Auto-Update is set in the Item Properties of this panel), see [Text Input](#)<sup>951</sup>.

**▼ WVideoFile**

WVideoFile,ID,File

Example:

WVideoFile,2,C:\coolux\content Pandora\MediaLoops 00201-00300\00214\_kiosk.mpg

Loads the file 00214\_kiosk.mpg from the specified directory into the [Videoplayer](#)<sup>956</sup> with the ID 2.

**▼ WVideoControl,....,Play**

WVideoControl,ID,Play

Example:

WVideoControl,2,Play

Plays the file that is loaded into the [Videoplayer](#)<sup>956</sup> with the ID 2.

**▼ WVideoControl,....,Loop**

WVideoControl,ID,Loop

Example:

WVideoControl,2,Loop

Loops the file that is played in the [Videoplayer](#)<sup>956</sup> with the ID 2.

**▼ WVideoControl,....,Pause**

WVideoControl,ID,Pause

Example:

WVideoControl,2,Pause

Pauses the file that is played in the [Videoplayer](#)<sup>956</sup> with the ID 2.

**▼ WVideoControl,....,Stop**

WVideoControl,ID,Stop

Example:  
WDVideoControl,2,Stop

Stops the file that is played in the [Videoplayer](#)<sup>956</sup> with the ID.2.

### ▼ **WDVideoGotoTime**

WDVideoGotoTime,ID,Second

Example:  
WDVideoGotoTime,1,80

Jumps in the file loaded to [Videoplayer](#)<sup>956</sup> 1 to the time 1min 20 sec (80 sec).

### ▼ **WDVideoGotoTimeRelative**

WDVideoGotoTimeRelative,ID,Second

Example:  
WDVideoGotoTimeRelative,1,-25

Jumps in the file loaded to [Videoplayer](#)<sup>956</sup> 1 to the time 25 seconds backward.

To jump forward 15 seconds enter WDVideoGotoTimeRelative,1,15

### ▼ **WDVideoSetVolume**

WDVideoSetVolume,ID,Value

Example:  
WDVideoSetVolume,2,50

Sets the volume for the [Videoplayer](#)<sup>956</sup> with the ID 2 to the value 50. The value for volume ranges from 0 to 100.

### ▼ **WDVideoVolumeUp**

WDVideoVolumeUp,ID,Value

Example:  
WDVideoVolumeUp,2,10

Increases the volume of the [Videoplayer](#)<sup>956</sup> with the ID 2 by 10 steps. The value for volume ranges from 0 to 100.

### ▼ **WDVideoVolumeDown**

WDVideoVolumeDown,ID,Value

Example:  
WDVideoVolumeDown,2,10



Decreases the volume of the [Videoplayer](#)<sup>956</sup> with the ID 2 by 10 steps. The value for volume ranges from 0 to 100.

### ▼ **VString**

VString,Name,Value

Example:  
VString,City,Cologne

Creates the variable "City" as String (ASCII Text). Its value is "Cologne".

To monitor all variables, their type and value, please refer to the [Variable List](#)<sup>1193</sup>.

### ▼ **VInt**

VInt,Name,Value

Example:  
VInt,Counter,32

Creates the variable "Counter" as Integer (number without decimal places). Its value is "32".

To monitor all variables, their type and value, please refer to the [Variable List](#)<sup>1193</sup>.

### ▼ **VDouble**

VDouble,Name,Value

Example:  
VDouble,Result,2.54

Creates the variable "Result" as Double (number with decimal places).. Its value is 2.54.

To monitor all variables, their type and value, please refer to the [Variable List](#)<sup>1193</sup>.

### ▼ **VDelete**

VDelete,Name

Example:  
VDelete,City

Deletes the variable with the name "City".

To monitor all variables, their type and value, please refer to the [Variable List](#)<sup>1193</sup>.

### ▼ **VDeleteAll**

VDeleteAll

Example:  
VDeleteAll

Deletes all existing variables inside WD.

To monitor all variables, their type and value, please refer to the [Variable List](#)<sup>1193</sup>.

### ▼ **VValue**

VValue, VarName, Value

Example:  
VValue, Counter, 20

Applies the value "20" to the variable "Counter".

To monitor all variables, their type and value, please refer to the [Variable List](#)<sup>1193</sup>.

### ▼ **Variable = Value**

Variable = Value

Example:  
Counter = 20

Applies the value "20" to the variable "Counter".

To monitor all variables, their type and value, please refer to the [Variable List](#)<sup>1193</sup>.

### ▼ **Variable += Value**

Variable += Value

Example:  
Counter += 20

Adds the value "20" to the current value of the variable "Counter" and assigns the result to the same variable "Counter".

To monitor all variables, their type and value, please refer to the [Variable List](#)<sup>1193</sup>.

### ▼ **Variable -= Value**

Variable -= Value

Example:  
Counter -= 20

Subtracts the value "20" from the current value of the variable "Counter" and assigns the result to the same variable "Counter".

To monitor all variables, their type and value, please refer to the [Variable List](#)<sup>1193</sup>.

### ▼ Variable \*= Value

Variable \*= Value

Example:

Counter \*= 20

Multiplies the current value of the variable "Counter" with the value "20" and assigns the result to the same variable "Counter".

To monitor all variables, their type and value, please refer to the [Variable List](#)<sup>1193</sup>.

### ▼ Variable /= Value

Variable /= Value

Example:

Counter /= 20

Divides the current value of the variable "Counter" with the value "20" and assigns the result to the same variable "Counter".

To monitor all variables, their type and value, please refer to the [Variable List](#)<sup>1193</sup>.

### ▼ VGetNodeVal

VGetNodeVal,VarName,NodeID,ParamID

Example:

VGetNodeVal,Counter,10,1

Applies the value of Node 10, Parameter 1 to the variable "Counter".

To monitor all variables, their type and value, please refer to the [Variable List](#)<sup>1193</sup>.

### ▼ VGetFaderVal

VGetFaderVal,VarName,FaderID

Example:

VGetFaderVal,Counter,1

Applies the value of Fader 1 to the variable "Counter".

To monitor all variables, their type and value, please refer to the [Variable List](#)<sup>1193</sup>.

### ▼ VGetLabelText

VGetLabelText,VarName,LabelID

Example:

VGetLabelText,City,2

Applies the text of Label 2 to the variable "City".

To monitor all variables, their type and value, please refer to the [Variable List](#)<sup>1193</sup>.

### ▼ **VGetTextboxText**

VGetTextboxText,VarName,TextboxID

Example:

VGetTextboxText,V\_Test,1

Applies the text of Textbox 1 to the variable "V\_Test".

To monitor all variables, their type and value, please refer to the [Variable List](#)<sup>1193</sup>.

### ▼ **VMultiply**

VMultiply,VarName,Var1,Var2

Example:

VMultiply,V\_Multi,Counter1,Counter2

Multiplies the values of the variables Counter1 and Counter2 and passes this Multiply result to the variable V\_Multi.

To monitor all variables, their type and value, please refer to the [Variable List](#)<sup>1193</sup>.

### ▼ **VDivide**

VDivide,VarName,Var1,Var2

Example:

VDivide,V\_Divide,Counter1,Counter2

Divides the variable Counter1 by the variable Counter2 and passes this Divide result to the variable V\_Divide.

To monitor all variables, their type and value, please refer to the [Variable List](#)<sup>1193</sup>.

### ▼ **VAdd**

VAdd,VarName,Var1,Var2

Example:

VAdd,V\_Add,Counter1,Counter2

Adds the variable Counter1 and Counter2 and passes this Add result to the variable V\_Add.

To monitor all variables, their type and value, please refer to the [Variable List](#)<sup>1193</sup>.

### ▼ VSubtract

VSubtract,VarName,Var1,Var2

Example:

VSubtract,V\_Sub,Counter1,Counter2

Subtracts the variable Counter2 from Counter1 and passes this Subtract result to the variable V\_Sub.

To monitor all variables, their type and value, please refer to the [Variable List](#)<sup>1193</sup>.

### ▼ VPow

VPow,VarName,Var1,Var2

Example:

VPow,V\_Power,Counter1,Counter2

Raises the variable Counter1 to the power of Counter2 and passes this Power result to the variable V\_Power.

To monitor all variables, their type and value, please refer to the [Variable List](#)<sup>1193</sup>.

### ▼ VSqrt

VSqrt,VarName,Var1

Example:

VSqrt,V\_Square,Counter1

Calculates the square root of the variable Counter1 passes this Sqrt result to the variable V\_Square.

To monitor all variables, their type and value, please refer to the [Variable List](#)<sup>1193</sup>.

### ▼ WDWait

WDWait,Seconds

Example:

WDWait,5.5

WD waits 5.5 seconds (5500ms) before the next command in the script list is executed.

### ▼ WDWaitCancelItem

WDWaitCancelItem,ItemName

Example:

WDWaitCancelItem,CustomScript1

Cancels the running WDWait commands executed by Custom Script Button 1.

Please note that a script list currently executing a WDWait command will be canceled at this point as well.

---

### ▼ **WDWaitCancelAll**

WDWaitCancelAll

Example:  
WDWaitCancelAll

Cancels all running WDWait commands.  
Please note that a script list currently executing a WDWait command will be canceled at this point as well.

### ▼ **WDWebBrowserContent**

WDWebBrowserContent,BrowserID,Url

Example:  
WDWebBrowserContent,1,www.coolux.de

Displays the web site with the address <http://www.coolux.de> in the Web Browser with the ID 1, see [Web Browser](#)<sup>958</sup>.

### ▼ **WDWebBrowserClearCache**

WDWebBrowserClearCache

Example:  
WDWebBrowserClearCache

Clears the cache of the web browser, see [Web Browser](#)<sup>958</sup>.

### ▼ **WDWheelGoUp**

WDWheelGoUp,ID,Value

Example:  
WDWheelGoUp,7,10

Adds immediately 10 values to the value of Wheel 7, see [Wheel](#)<sup>928</sup>.

### ▼ **WDWheelGoDown**

WDWheelGoDown,ID,Value

Example:  
WDWheelGoDown,7,10

Subtracts immediately 10 values from the value of Wheel 7, see [Wheel](#)<sup>928</sup>.

### ▼ **WDWheelValue**

WDWheelValue,ID,Value

Example:  
WDWheelValue,7,33

Sets the Wheel 7 to value 33 immediately, see [Wheel](#)<sup>928</sup>.

#### ▼ **WDWheelFactor**

WDWheelFactor,ID,Value

Example:  
WDWheelFactor,7,5

Sets the factor of Wheel 7 to the value 5, see [Wheel](#)<sup>928</sup>.

#### ▼ **WDXYPanelResetDefault**

WDXYPanelResetDefault,PanelID

Example:  
WDXYPanelResetDefault,1

Resets all current values inside XY Panel with the ID 1 back to the default values entered in its Item Properties.

#### ▼ **WDXYPanelSetXDefault**

WDXYPanelSetXDefault,PanelID,Value

Example:  
WDXYPanelSetXDefault,1,32000

Sets the value for the default of Mouse X inside XY Panel with the ID 1 to 32000.

#### ▼ **WDXYPanelSetYDefault**

WDXYPanelSetYDefault,PanelID,Value

Example:  
WDXYPanelSetYDefault,1,34000

Sets the value for the default of Mouse Y inside XY Panel with the ID 1 to 34000.

#### ▼ **WDXYPanelSetXPosRelative**

WDXYPanelSetXPosRelative,PanelID,Value

Example:  
WDXYPanelSetXPosRelative,1,22000

Sets the value for the internal Relative X Position inside XY Panel with the ID 1 to 22000.

---

**▼ WDXYPanelResetXPosRelative**

WDXYPanelResetXPosRelative,PanelID

Example:

WDXYPanelResetXPosRelative,1

Resets the value for the internal Relative X Position inside XY Panel with the ID 1 back to its default value.

**▼ WDXYPanelSetYPosRelative**

WDXYPanelSetYPosRelative,PanelID,Value

Example:

WDXYPanelSetYPosRelative,1,22000

Sets the value for the internal Relative Y Position inside XY Panel with the ID 1 to 22000.

**▼ WDXYPanelResetYPosRelative**

WDXYPanelResetYPosRelative,PanelID

Example:

WDXYPanelResetYPosRelative,1

Resets the value for the internal Relative Y Position inside XY Panel with the ID 1 back to its default value.

**▼ WDXYPanelSetDistanceRelative**

WDXYPanelSetDistanceRelative,PanelID,Value

Example:

WDXYPanelSetDistanceRelative,1,18000

Sets the value for the internal Relative Distance inside XY Panel with the ID 1 to 18000.

**▼ WDXYPanelResetDistanceRelative**

WDXYPanelResetDistanceRelative,PanelID

Example:

WDXYPanelResetDistanceRelative,1

Resets the value for the internal Relative Distance inside XY Panel with the ID 1 back to its default value.

**▼ WDXYPanelSetAngleRelative**

WDXYPanelSetAngleRelative,PanelID,Value



Example:

```
WDXYPanelSetAngleRelative,1,18000
```

Sets the value for the internal Relative Angle inside XY Panel with the ID 1 to 18000.

### ▼ **WDXYPanelResetAngleRelative**

```
WDXYPanelResetXPosRelative,PanelID
```

Example:

```
WDXYPanelResetXPosRelative,1
```

Resets the value for the internal Relative X Position inside XY Panel with the ID 1 back to its default value.

### ▼ **WDEnable**

```
WDEnable
```

Example:

```
WDEnable
```

Enables the GUI of Widget Designer if it was disabled before.

### ▼ **WDDisable**

```
WDDisable
```

Example:

```
WDDisable
```

Disables the GUI of Widget Designer.

Please note, that you won't have ANY access to the WD GUI anymore!

Enable the GUI for example via the incoming command (WDEnable) in the [Remoting Tool](#)<sup>1182</sup>. The used connection has to be established first.

### ▼ **WDLoad**

```
WDLoad,File
```

Example:

```
WDLoad,C:\coolux\content Widget\test.wdp
```

Loads the file "test.wdp" from the specified directory without saving the current WD project.

### ▼ **WDLoadProject**

```
WDLoadProject,File
```

Example:

```
WDLoadProject,C:\coolux\content\test\test.wdp
```

Loads the file “test.wdp” from the specified directory without saving the current WD project.

### ▼ **WDLoadProjectRestart**

```
WDLoadProjectRestart,File
```

Example:

```
WDLoadProjectRestart,C:\coolux\content\test\test.wdp
```

Restarts Widget Designer and loads the file “test.wdp” from the specified directory without saving the current WD project. With restarting WD you can clean up the entire memory usage from the old project.

### ▼ **WDNew**

```
WDNew
```

Example:

```
WDNew
```

Creates a new WD project without saving the current WD project.

### ▼ **WDClose**

```
WDClose
```

Example:

```
WDClose
```

Closes the current WD project. A pop-up dialog is going to ask you if you want to save the current changes.

### ▼ **WDCloseSilent**

```
WDCloseSilent
```

Example:

```
WDCloseSilent
```

Closes the current WD project without saving it (there will be no pop-up dialog asking to save the project).

### ▼ **WDSaveFile**

```
WDSaveFile,Filename
```

Example:

```
WDSaveFile,C:\coolux\content\project_test\project_test.wdp
```

---

Saves the file "project\_test.wdp" from the specified directory.

### ▼ **WDSave**

WDSave

Example:  
WDSave

Saves the current WD project.

### ▼ **WDSaveAs**

WDSaveAs

Example:  
WDSaveAs

Opens the WD "Save as" dialog.

### ▼ **WDSaveAsCopy**

WDSaveAsCopy

Example:  
WDSaveAsCopy

This opens the Save As dialog box to save a new version of the existing file. After saving the copy you will keep working in the current file with the current saving path. You might want to save the current file in addition to making a copy.

### ▼ **WDViewerModeEnable**

WDViewerModeEnable

Example:  
WDViewerModeEnable

This enables the [Viewer Mode](#)<sup>864</sup> in Widget Designer meaning that the user cannot edit the interface.

- no [Edit Mode](#)<sup>870</sup> possible => no repositioning of GUI elements, etc.

- the right-click menu as well as the [Menu Bar](#)<sup>869</sup> only allow to load a new WD File => no saving (under old or new name), no Item Properties, etc

- the Run Mode works without restriction.

### ▼ **WDViewerModeDisable**

WDViewerModeDisable

Example:  
WDViewerModeDisable

This disables the [Viewer Mode](#)<sup>864</sup> in Widget Designer meaning that the user has full access to the WD options:

- Edit Mode and Run Mode possible
- the right-click menu as well as the Menu Bar offer all options

#### ▼ **WDRestart**

WDRestart

Example:  
WDRestart

This restarts Widget Designer without saving the current WD project and opens a new empty file. With restarting WD you can clean up the entire memory usage from the old project.

#### ▼ **WDDisableAltF4**

WDDisableAltF4

Example:  
WDDisableAltF4

This disables the shortcut Alt+F4 which closes an application.

#### ▼ **WDEnableAltF4**

WDEnableAltF4

Example:  
WDEnableAltF4

This enables the shortcut Alt+F4 which closes an application.

#### ▼ **ApplicationStart**

ApplicationStart,Filepath

Example:

ApplicationStart,C:\program files\VideoLAN\VLC\vlc.exe

ApplicationStart,mspaint

ApplicationStart,C:\Program Files (x86)\coolux\Widget Designer 4.7 Rev 1294  
\PB\_Widget\_Designer.exe

Starts the VLC Player, Microsoft Paint and Widget Designer on the local WD computer.

ApplicationStart,Filepath,Optional Commandline Arguments

Example:

ApplicationStart,C:\program files\VideoLAN\VLC\vlc.exe,C:\Music\Sound.mp3

ApplicationStart,C:\Program Files (x86)\coolux\Widget Designer 4.7 Rev 1294  
\PB\_Widget\_Designer.exe,Q1 ViewerMode

Starts the VLC Player and plays back the file "Sound.mp3" as this command line is supported by VLC.

Widget Designer starts with two commandline arguments:

- [Q1](#)<sup>[87]</sup>: in the upper left quarter of your desktop
- [ViewerMode](#)<sup>[86]</sup>: very restricted access to WD options

## ▼ ApplicationClose

ApplicationClose,Processname

Example:

ApplicationClose,notepad

Closes all running notepad applications. Please have a look into the windows taskmanager to get the correct process name of the running application you want to close, enter this name without ".exe".

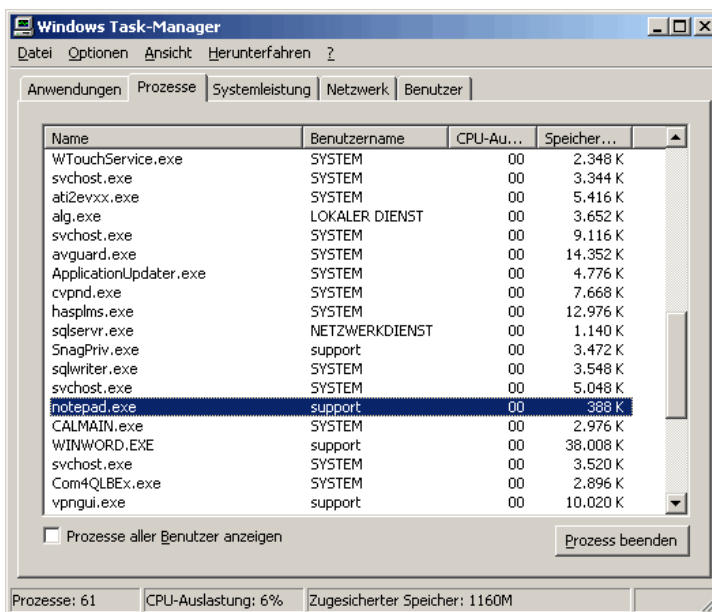

## ▼ ApplicationKill

ApplicationKill,Processname

Example:

ApplicationKill,vc

ApplicationKill,mspaint

ApplicationKill,PB\_Widget\_Designer

This ends the process of VLC Player, Microsoft Paint and Widget Designer of the local WD computer without asking to save any projects. Please have a look into the windows taskmanager to get the correct process name of the running application you want to close, enter this name without ".exe".

## ▼ ApplicationKillAllOtherWDInstances

ApplicationKillAllOtherWDInstances

Example:  
ApplicationKillAllOtherWDInstances

This ends all background processes of Widget Designer that do not belong to the one currently running and have added up by mistake. This command is of interest for permanent installations without technical staff.

#### ▼ **Art-NetInputEnabled**

Art-NetInputEnabled

Example:  
Art-NetInputEnabled

Enables Art-Net Input in the [Connection Manager](#)<sup>1166</sup>.

#### ▼ **Art-NetInputDisabled**

Art-NetInputDisabled

Example:  
Art-NetInputDisabled

Disables Art-Net Input in the [Connection Manager](#)<sup>1166</sup>.

#### ▼ **Art-NetOutputEnabled**

Art-NetOutputEnabled

Example:  
Art-NetOutputEnabled

Enables Art-Net Output in the [Connection Manager](#)<sup>1166</sup>.

#### ▼ **Art-NetOutputDisabled**

Art-NetOutputDisabled

Example:  
Art-NetOutputDisabled

Disables Art-Net Output in the [Connection Manager](#)<sup>1166</sup>.

#### ▼ **Art-NetSetVal8bit**

Art-NetSetVal8bit,Subnet 0-15,Universe 0-15,Channel,Value 0-255

Example:  
Art-NetSetVal8bit,0,1,38,255

Sets the Channel 38 on Art-Net Subnet 0, Universe 1 to the value 255.

---

Art-Net Output needs to be enabled, see [Connection Manager](#)<sup>1166</sup>.

### ▼ **Art-NetSetVal16bit**

Art-NetSetVal16bit,Subnet 0-15,Universe 0-15,Channel,Value 0-65535

Example:

Art-NetSetVal16bit,0,1,41,255

Sets the Channel 41 on Art-Net Subnet 0, Universe 1 to the value 32768.

Please note, that the next channel you can control is now Channel 43 because of the 16 bit value sent to Channel 41 (and 42).

Art-Net Output needs to be enabled, see [Connection Manager](#)<sup>1166</sup>.

### ▼ **Art-NetDisableUniverse**

Art-NetDisableUniverse,Subnet 0-15,Universe 0-15

Example:

Art-NetDisableUniverse,0,1

Disables the Art-Net Output on Art-Net Subnet 0, Universe 1. The specified Art-Net Universe will be removed from the Universe List in the [Connection Manager](#)<sup>1166</sup>.

### ▼ **Art-NetDisableAllUniverses**

Art-NetDisableAllUniverses

Example:

Art-NetDisableAllUniverses

Disables the Art-Net Output on all Universes. This command clears the Universe List in the [Connection Manager](#)<sup>1166</sup>.

### ▼ **OpenArt-NetMonitor**

OpenArt-NetMonitor

Example:

OpenArt-NetMonitor

Opens the [Art-NetMonitor](#)<sup>1177</sup>.

### ▼ **OpenArt-NetUniverseList**

OpenArt-NetUniverseList

Example:

OpenArt-NetUniverseList

---

Opens the Art-Net Universe List, see [Connection Manager](#)<sup>1166</sup>.

### ▼ COMStart

COMStart,ID

Example:  
COMStart,1

Starts the COM Port Connection with the ID 1, see [Connection Manager](#)<sup>1166</sup>.

### ▼ COMStop

COMStop,ID

Example:  
COMStop,1

Stops the COM Port Connection with the ID 1, see [Connection Manager](#)<sup>1166</sup>.

### ▼ COMSend

COMSend,ID,Message

Example:  
COMSend,1,Play

Sends the message "Play" via the COM Port Connection with the ID 1, see [Connection Manager](#)<sup>1166</sup>.

### ▼ COMSendHex

COMSendHex,ID,Message

Example:  
COMSendHex,1,Play

Sends the message "Play" in hexadecimal values via the COM Port Connection with the ID 1, see [Connection Manager](#)<sup>1166</sup>.

See here the [DEC HEX ASCII Table](#)<sup>970</sup>.

### ▼ COMSendDec

COMSendDec,ID,Message

Example:  
COMSendDec,1,Play

Sends the message "Play" in decimal values via the COM Port Connection with the ID 1, see [Connection Manager](#)<sup>1166</sup>.

See here the [DEC HEX ASCII Table](#)<sup>970</sup>.



---

### ▼ DMXLinkInEnable

DMXLinkInEnable

Example:

DMXLinkInEnable

Enables the Widget Designer to receive values via the coolux DMX Link, see [Connection Manager](#)<sup>1166</sup>.

### ▼ DMXLinkInDisable

DMXLinkInDisable

Example:

DMXLinkInDisable

Disables the Widget Designer to receive values via the coolux DMX Link, see [Connection Manager](#)<sup>1166</sup>.

### ▼ DMXLinkInReset

DMXLinkInReset

Example:

DMXLinkInReset

Resets the value of all channels received via the coolux DMX Link, see [Connection Manager](#)<sup>1166</sup>.

### ▼ DMXLinkOutSetVal8bit

DMXLinkOutSetVal8bit,Channel,Value 0-255

Example:

DMXLinkOutSetVal8bit,255,20

Sends out the value 20 on channel 255 via the coolux DMX Link, see [Connection Manager](#)<sup>1166</sup>.

### ▼ DMXLinkOutSetVal16bit

DMXLinkOutSetVal16bit,Channel,Value 0-65535

Example:

DMXLinkOutSetVal16bit,255,32768

Sends out the value 32768 on channel 255 via the coolux DMX Link, see [Connection Manager](#)<sup>1166</sup>.

### ▼ DMXLinkOutEnable

DMXLinkOutEnable

Example:  
DMXLinkOutEnable

Enables the Widget Designer to send out values via the coolux DMX Link, see [Connection Manager](#)<sup>1166</sup>.

### ▼ DMXLinkOutDisable

DMXLinkOutDisable

Example:  
DMXLinkOutDisable

Disables the Widget Designer to send out values via the coolux DMX Link, see [Connection Manager](#)<sup>1166</sup>.

### ▼ DMXLinkOutReset

DMXLinkOutReset

Example:  
DMXLinkOutReset

Resets the value of all channels send out via the coolux DMX Link, see [Connection Manager](#)<sup>1166</sup>.

### ▼ EmailSend

EmailSend, To, Subject, Message

Example:  
EmailSend, support@coolux.de, Question WD, What are the system requirements for running WD?

Sends an Email with the subject "Question WD" and the message "What are the system requirements for running WD?" to support@coolux.de.

Please use the [Email Settings Tool](#)<sup>1214</sup> first to setup all incoming and outgoing Email communication.

### ▼ EmailSendAtt

EmailSendAtt, To, Att, Subject, Message

Example:  
EmailSendAtt, support@coolux.de, C:\coolux\commandlist.txt, Question WD, Please explain the commands!

Sends an Email with the subject "Question WD", the message "Please explain the commands!" and the attachment "commandlist.txt" from the specified directory (C:\coolux\commandlist.txt) to support@coolux.de.

Please use the [Email Settings Tool](#)<sup>1214</sup> first to setup all incoming and outgoing Email communication.

### ▼ EmailSendFromLabel

EmailSendFromLabel,To,Subject From LabelID,Message From LabelID

Example:

EmailSendFromLabel,support@coolux.de,1,2

Sends an Email with the text of Label 1 as subject and with the text of Label 2 as message to support@coolux.de.

Please use the [Email Settings Tool](#)<sup>1214</sup> first to setup all incoming and outgoing Email communication.

### ▼ EmailSendFromTextBox

EmailSendFromTextBox,To,Subject From TextBoxID,Message From TextBoxID

Example:

EmailSendFromTextBox,support@coolux.de,1,2

Sends an Email with the text of TextBox 1 as subject and with the text of TextBox 2 as message to support@coolux.de.

Please use the [Email Settings Tool](#)<sup>1214</sup> first to setup all incoming and outgoing Email communication.

### ▼ EmailSendDisable

EmailSendDisable

Example:

EmailSendDisable

When this command is executed, no email will be send out. Use the command EmailSendEnable to enable this function again.

Please use the [Email Settings Tool](#)<sup>1214</sup> to setup all incoming and outgoing Email communication.

### ▼ EmailSendEnable

EmailSendEnable

Example:

EmailSendEnable

Enables the EmailSend function after it was disabled.

Please use the [Email Settings Tool](#)<sup>1214</sup> to setup all incoming and outgoing Email communication.

### ▼ EmailServerSet

EmailServerSet,EmailServerSmpt

Example:  
EmailServerSet,smtp.googlemail.com

Sets the SMTP Mail Server to smtp.googlemail.com, please see the [Email Settings Tool](#)<sup>1214</sup>.

#### ▼ EmailAddressSet

EmailAddressSet,EmailAddress

Example:  
EmailAddressSet,support@coolux.de

Sets the Email Address for the outgoing Email Server to "support@coolux.de", please see the [Email Settings Tool](#)<sup>1214</sup>.

#### ▼ EmailUsernameSet

EmailUsernameSet,Username

Example:  
EmailUsernameSet,Username

Sets the Email Username for the outgoing Email Server to "support", please see the [Email Settings Tool](#)<sup>1214</sup>.

#### ▼ EmailPasswordSet

EmailPasswordSet>Password

Example:  
EmailPasswordSet,SECRET

Sets the Email Password for the outgoing Email Server to "SECRET", please see the [Email Settings Tool](#)<sup>1214</sup>.

#### ▼ EmailUseSSL,True

EmailUseSSL,True

Example:  
EmailUseSSL,True

Checks the option "Use SSL" for the outgoing Email Server, please see the [Email Settings Tool](#)<sup>1214</sup>.

#### ▼ EmailUseSSL,False

EmailUseSSL,False

Example:  
EmailUseSSL,False

Disables the option "Use SSL" for the outgoing Email Server, please see the [Email Settings Tool](#)<sup>1214</sup>.

### ▼ EmailUseDefaultAuthentication,True

EmailUseDefaultAuthentication,True

Example:

EmailUseDefaultAuthentication,True

Checks the option "Use Default Authentication" for the outgoing Email Server, please see the [Email Settings Tool](#)<sup>1214</sup>.

### ▼ EmailUseDefaultAuthentication,False

EmailUseDefaultAuthentication,False

Example:

EmailUseDefaultAuthentication,False

Disables the option "Use Default Authentication" for the outgoing Email Server, please see the [Email Settings Tool](#)<sup>1214</sup>.

### ▼ OpenEmailSettings

OpenEmailSettings

Example:

OpenEmailSettings

Opens the [Email Settings Tool](#)<sup>1214</sup>.

### ▼ CloseEmailSettings

CloseEmailSettings

Example:

CloseEmailSettings

Closes the [Email Settings Tool](#)<sup>1214</sup>.

### ▼ HTTPRequest

HTTPRequest,Request

Example:

HTTPRequest,http://192.168.50.40/cgi-bin/shutter\_on

This allows to send single HTTP commands via scripts directly to a web server. It is not necessary to establish the connection from Widget Designer to the external web server using the Connection Manager but they need to be connected via a switch for example.

The HTTP Request is useful when working with an external web server. It does not apply to the integrated [WD Web Server feature](#)<sup>1177</sup>. As well, you may control external devices, e.g. a projector supporting the HTTP protocol. This is an alternative to controlling them via a RS232 / Serial protocol. If the external web server requires a username and / or a password and supports a HTTP Basic

Authentication (in most browsers that gives you a pop-up window asking for credentials) then you can embed the user in the URL like this

```
HTTPRequest,http://USERNAME@192.168.50.40/cgi-bin/shutter_on
```

```
HTTPRequest,http://USERNAME:PASSWORD@192.168.50.40/cgi-bin/shutter_on
```

(USERNAME and PASSWORD have to be replaced)

### ▼ KeyboardKeyPress

KeyboardKeyPress,Keycode

Example:

```
KeyboardKeyPress,A
```

Executes a keystroke with the character A.

The keys argument can specify any single key or any key combined with ALT, CTRL, or SHIFT (or any combination of those keys). Each key is represented by one or more characters, such as a for the character "a", or {ENTER} for the ENTER key.

To combine a key with SHIFT, precede the key code with + (plus sign).

To combine a key with CTRL, precede the key code with ^ (caret).

To combine a key with ALT, precede the key code with % (percent sign).

To specify repeating keys, use the form {key number}. You must put a space between key and number. For example, {LEFT 42} means "press the LEFT ARROW key 42 times"; {h 10} means "press h 10 times."

The following table lists the codes that can be used to specify characters that are not displayed when you press the corresponding key (such as ENTER or TAB).

BACKSPACE {BACKSPACE} or {BS}, BREAK {BREAK}, CAPS LOCK {CAPSLOCK}, CLEAR {CLEAR}, DELETE {DELETE} or {DEL}, DOWN ARROW {DOWN}, END {END}, ENTER (numeric keypad) {ENTER}, ENTER ~, ESC {ESCAPE} or {ESC}, HELP {HELP}, HOME {HOME}, INS {INSERT}, LEFT ARROW {LEFT}, NUM LOCK {NUMLOCK}, PAGE DOWN {PGDN}, PAGE UP {PGUP}, RETURN {RETURN}, RIGHT ARROW {RIGHT}, SCROLL LOCK {SCROLLLOCK}, TAB {TAB}, UP ARROW {UP}, F1 through F15 {F1} through {F15}.

If you want to send a keystroke to an application that currently is not activated, you may want to use the command [WindowFocus.WindowTitleText](#)<sup>[1429]</sup>.

### ▼ KeyboardVolumeUp

KeyboardVolumeUp

Example:

```
KeyboardVolumeUp
```

Executes the Keyboards Volume Up Button.

### ▼ KeyboardVolumeDown

KeyboardVolumeDown

---

Example:  
KeyboardVolumeDown

Executes the Keyboards Volume Down Button.

### ▼ **KeyboardToggleVolume**

KeyboardToggleVolume

Example:  
KeyboardToggleVolume

Toggles the Keyboards Sound On / Off Button.

### ▼ **KinectStart**

KinectStart

Example:  
KinectStart

Starts the Kinect device. See [Kinect Tool](#)<sup>1162</sup>.

### ▼ **KinectEnable**

KinectEnable

Example:  
KinectEnable

Enables the Kinect device. See [Kinect Tool](#)<sup>1162</sup>.

### ▼ **KinectDisable**

KinectDisable

Example:  
KinectDisable

Disables the Kinect device. See [Kinect Tool](#)<sup>1162</sup>.

### ▼ **KinectSetTilt**

KinectSetTilt,-8000>+8000

Example:  
KinectSetTilt,2500

Tilts the Kinect device via the integrated servo motor to the value 2500. As it can be tilted 27° up and down, the value 2500 is equivalent to ~8,5°. See [Kinect Tool](#)<sup>1162</sup>.

---

### ▼ KinectSetDepthThreshold

KinectSetDepthThreshold,0-2047

Example:

KinectSetDepthThreshold,1000

Sets the Depth Threshold to the value 1000. See [Kinect Tool](#)<sup>1162</sup>.

### ▼ KinectSetNearThreshold

KinectSetNearThreshold,0-2047

Example:

KinectSetNearThreshold,800

Sets the Near Threshold to the value 900. See [Kinect Tool](#)<sup>1162</sup>.

### ▼ KinectSetPoints

KinectSetPoints,1-8

Example:

KinectSetPoints,4

Changes the current amount of points to 4 points. See [Kinect Tool](#)<sup>1162</sup>.

### ▼ KinectSetBlur

KinectSetBlur,0-15

Example:

KinectSetBlur,8

Changes the blur option to the value 8. See [Kinect Tool](#)<sup>1162</sup>.

### ▼ KinectSetInflate

KinectSetInflate,0-15

Example:

KinectSetInflate,8

Changes the inflate option to the value 8. See [Kinect Tool](#)<sup>1162</sup>.

### ▼ KinectSetShrink

KinectSetShrink,0-15

Example:

KinectSetShrink,8



---

Changes the shrink option to the value 8. See [Kinect Tool](#)<sup>1162</sup>.

#### ▼ **KinectSetMinWidth**

KinectSetMinWidth,Value

Example:

KinectSetMinWidth,50

Sets the minimum width of a point to the value 50 (px). See [Kinect Tool](#)<sup>1162</sup>.

#### ▼ **KinectSetMinHeight**

KinectSetMinHeight,Value

Example:

KinectSetMinHeight,50

Sets the minimum height of a point to the value 50 (px). See [Kinect Tool](#)<sup>1162</sup>.

#### ▼ **KinectSetMaxWidth**

KinectSetMaxWidth,Value

Example:

KinectSetMaxWidth,250

Sets the maximum width of a point to the value 250 (px). See [Kinect Tool](#)<sup>1162</sup>.

#### ▼ **KinectSetMaxHeight**

KinectSetInflate,0-15

Example:

KinectSetInflate,8

Changes the inflate option to the value 8. See [Kinect Tool](#)<sup>1162</sup>.

#### ▼ **KinectSetMaxDelta**

KinectSetShrink,0-15

Example:

KinectSetShrink,8

Changes the shrink option to the value 8. See [Kinect Tool](#)<sup>1162</sup>.

#### ▼ **KinectSetDamping**

KinectSetDamping,Value

Example:  
KinectSetDamping,0.1

Sets the damping for the Kinect to 0,1.

The damping allows to reduce noisy input values. This value can be changed from 0,1 = maximum damping up to 1 = no damping, see [Kinect Tool](#)<sup>1162</sup>.

### ▼ KinectMouseModeDefault

KinectMouseModeDefault

Example:  
KinectMouseModeDefault

Sets the Mouse Mode to default:  
Default generates mouse down on enter and mouse up on leave, see [Kinect Tool](#)<sup>1162</sup>.

### ▼ KinectMouseModeOnEnter

KinectMouseModeOnEnter

Example:  
KinectMouseModeOnEnter

Sets the Mouse Mode to OnEnter:  
The click is generated on enter, see [Kinect Tool](#)<sup>1162</sup>.

### ▼ KinectMouseModeOnLeave

KinectMouseModeOnLeave

Example:  
KinectMouseModeOnLeave

Sets the Mouse Mode to OnLeave:  
The click is generated on leave, see [Kinect Tool](#)<sup>1162</sup>.

### ▼ KinectMouseModeOn2ndHand

KinectMouseModeOn2ndHand

Example:  
KinectMouseModeOn2ndHand

Sets the Mouse Mode to On2ndHand:  
The click is generated as soon as a 2nd point (through the 2nd hand) is detected, see [Kinect Tool](#)<sup>1162</sup>.

### ▼ **KinectMouseModeEnable**

KinectMouseModeEnable

Example:

KinectMouseModeEnable

Enables the mouse if Point1 input data should control the mouse of your WD computer, see [Kinect Tool](#)<sup>1162</sup>.

### ▼ **KinectMouseModeDisable**

KinectMouseModeDisable

Example:

KinectMouseModeDisable

Disables the mouse control via the Kinect, see [Kinect Tool](#)<sup>1162</sup>.

### ▼ **KinectEnableClick**

KinectEnableClick

Example:

KinectEnableClick

If this option is enabled the mouse cursor generates clicks, see [Kinect Tool](#)<sup>1162</sup>. You can choose between the following Mouse Modes:

[KinectMouseModeDefault](#)<sup>1410</sup>

[KinectMouseModeOnEnter](#)<sup>1410</sup>

[KinectMouseModeOnLeave](#)<sup>1410</sup>

[KinectMouseModeOn2ndHand](#)<sup>1410</sup>

### ▼ **KinectDisableClick**

KinectDisableClick

Example:

KinectDisableClick

If this option is disabled the mouse cursor controlled by the Kinect won't generate clicks, see [Kinect Tool](#)<sup>1162</sup>.

### ▼ **KinectSetLedOff**

KinectSetLedOff

Example:

KinectSetLedOff

Turns off the Status LED of the Kinect device.

---

**▼ KinectSetLedRed**

KinectSetLedRed

Example:  
KinectSetLedRed

Will light up the Status LED of the Kinect device in red.

**▼ KinectSetLedGreen**

KinectSetLedGreen

Example:  
KinectSetLedGreen

Will light up the Status LED of the Kinect device in green.

**▼ KinectSetLedGreenBlink**

KinectSetLedGreenBlink

Example:  
KinectSetLedGreenBlink

Will flash up the Status LED of the Kinect device in green.

**▼ KinectSetLedOrange**

KinectSetLedOrange

Example:  
KinectSetLedOrange

Will light up the Status LED of the Kinect device in orange.

**▼ KinectSetLedOrangeRedBlink**

KinectSetLedOrangeRedBlink

Example:  
KinectSetLedOrangeRedBlink

Will flash up the Status LED of the Kinect device in orange and red.

**▼ OpenKinectDialog**

OpenKinectDialog

Example:  
OpenKinectDialog

---

Opens the [Kinect Tool](#)<sup>[1162]</sup>.

#### ▼ **LogitechPresenterR400Enabled**

LogitechPresenterR400Enabled

Example:

LogitechPresenterR400Enabled

Enables the Logitech Presenter R400.

#### ▼ **LogitechPresenterR400Disabled**

LogitechPresenterR400Disabled

Example:

LogitechPresenterR400Disabled

Disables the Logitech Presenter R400.

Script support for Chamsys MagicQ Remote Playback Commands (based on MagicQ default UDP Port 6553):

#### ▼ **MagicQActivatePlayback**

MagicQActivatePlayback,ID

Example:

MagicQActivatePlayback,8

Activates (starts) the playback 8 within MagicQ

#### ▼ **MagicQReleasePlayback**

MagicQReleasePlayback,ID

Example:

MagicQReleasePlayback,8

Releases (stops) the playback 8 within MagicQ.

#### ▼ **MagicQTestPlayback**

MagicQTestPlayback,ID

Example:

MagicQTestPlayback,8

Sets the playback 8 in test mode within MagicQ: activates playback 8 and sets the level to 100%.

---

### ▼ **MagicQUntestPlayback**

MagicQUntestPlayback, ID

Example:

MagicQUntestPlayback, 8

Takes the playback 8 out of test mode within MagicQ: releases the playback 8 and sets the level to 0%.

### ▼ **MagicQGoOnPlayback**

MagicQGoOnPlayback, ID

Example:

MagicQGoOnPlayback, 8

Gives a Go on playback 8 within MagicQ.

### ▼ **MagicQStopOnPlayback**

MagicQStopOnPlayback, ID

Example:

MagicQStopOnPlayback, 8

Sets playback 8 within MagicQ to pause.

### ▼ **MagicQFastBackOnPlayback**

MagicQFastBackOnPlayback, ID

Example:

MagicQFastBackOnPlayback, 8

Goes back one step in the Cue Stack of Playback 8 without taking the step and fade times into account.

### ▼ **MagicQFastForwardOnPlayback**

MagicQFastForwardOnPlayback, ID

Example:

MagicQFastForwardOnPlayback, 8

Goes back one step in the Cue Stack of Playback 8 without taking the step and fade times into account.

### ▼ **MagicQChangePage**

MagicQChangePage, ID

Example:  
MagicQChangePage,11

Changes to playback page 11 within MagicQ.

#### ▼ **MagicQPlaybackLevel**

MagicQPlaybackLevel,ID,Level

Example:  
MagicQPlaybackLevel,8,90

#### ▼ **MidiInputEnabled**

MidiInputEnabled

Example:  
MidiInputEnabled

Enables Midi Input in the [Connection Manager](#)<sup>1166</sup>. Please choose a Midi Device first.

#### ▼ **MidiInputDisabled**

MidiInputDisabled

Example:  
MidiInputDisabled

Disables the Midi Input in the [Connection Manager](#)<sup>1166</sup>.

#### ▼ **MidiOutputEnabled**

MidiOutputEnabled

Example:  
MidiOutputEnabled

Enables Midi Output in the [Connection Manager](#)<sup>1166</sup>. Please choose a Midi Device first.

#### ▼ **MidiOutputDisabled**

MidiOutputDisabled

Example:  
MidiOutputDisabled

Disables the Midi Output in the [Connection Manager](#)<sup>1166</sup>.

### ▼ **MidiSendRawMsg**

MidiSendRawMsg,Status,Channel,Data1,Data2,Data3

Example:

MidiSendRawMsg,10,11,128,0,0

Sends a Midi Raw Message with the 5 Midi control bytes 10,11,128,0,0.

The Midi connection needs to be enabled in the [Connection Manager](#)<sup>1166</sup>.

### ▼ **MidiSendNoteOn**

MidiSendNoteOn,Channel 1-16,Note C0-G10,Velocity 0-127

Example:

MidiSendNoteOn,1,E5,80

Sends the Midi Note On command to Note E5 on channel 1 with velocity 80.

The Midi connection needs to be enabled in the [Connection Manager](#)<sup>1166</sup>.

### ▼ **MidiSendNoteOff**

MidiSendNoteOff,Channel 1-16,Note C0-G10

Example:

MidiSendNoteOff,1,E5

Sends the Midi Note Off command to Note E5 on channel 1.

The Midi connection needs to be enabled in the [Connection Manager](#)<sup>1166</sup>.

### ▼ **MidiSendProgramChange**

MidiSendProgramChange,Channel 1-16,Program 0-127

Example:

MidiSendProgramChange,1,20

Changes the current program for Midi channel 1 to the program 20.

The Midi connection needs to be enabled in the [Connection Manager](#)<sup>1166</sup>.

### ▼ **MidiSendControlChange**

MidiSendControlChange,Channel 1-16,Control 0-127,Value 0-127

Example:

MidiSendControlChange,1,35,127

Sets the Control 35 on Midi Channel 1 to the value 127.



---

The Midi connection needs to be enabled in the [Connection Manager](#)<sup>[1166]</sup>.

### ▼ **MouseMove**

MouseMove,xPos,yPos

Example:

MouseMove,200,100

Moves the mouse cursor to the X Position 200 px and Y Position 100 px.

Tip: If you want to display the current mouse values, create a [Mouse Input Node](#)<sup>[1038]</sup> and see its Item Properties.

### ▼ **MouseLeftClick**

MouseLeftClick

Example:

MouseLeftClick

Executes a Mouse Left Click.

### ▼ **MouseRightClick**

MouseRightClick

Example:

MouseRightClick

Executes a Mouse Right Click.

### ▼ **OpenConnectionManager**

OpenConnectionManager

Example:

OpenConnectionManager

Opens the [Connection Manager](#)<sup>[1166]</sup>.

### ▼ **OpenArt-NetMonitor**

OpenArt-NetMonitor

Example:

OpenArt-NetMonitor

Opens the [Art-NetMonitor](#)<sup>[1177]</sup>.

### ▼ **OpenArt-NetUniverseList**

---

OpenArt-NetUniverseList

Example:

OpenArt-NetUniverseList

Opens the Art-Net Universe List, see [Connection Manager](#)<sup>1166</sup>.

### ▼ OpenCITPBrowser

OpenCITPBrowser

Example:

OpenCITPBrowser

Opens the Thumbnail Browser, see [Network Configuration](#)<sup>865</sup>.

### ▼ OpenEventEditor

OpenEventEditor

Example:

OpenEventEditor

Opens the [Event Editor Tool](#)<sup>1188</sup>.

### ▼ OpenHelp

OpenHelp

Example:

OpenHelp

Opens this Help File.

### ▼ OpenIPConfiguration

OpenIPConfiguration

Example:

OpenIPConfiguration

Opens the [IP Configuration](#)<sup>865</sup> dialog.

### ▼ OpenKeyboardShortcuts

OpenKeyboardShortcuts

Example:

OpenKeyboardShortcuts

Opens the [Keyboard Shortcut Editor](#)<sup>1204</sup>.

---

### ▼ OpenKinectDialog

OpenKinectDialog

Example:  
OpenKinectDialog

Opens the [Kinect Tool](#)<sup>1162</sup>.

### ▼ OpenLoadFileDialog

OpenLoadFileDialog

Example:  
OpenLoadFileDialog

Opens the "Load File" dialog in WD to load an existing project.

### ▼ OpenMacroEditor

OpenMacroEditor

Example:  
OpenMacroEditor

Opens the [Macro Editor](#)<sup>1191</sup> dialog in WD.

### ▼ OpenMidiNoteEditor

OpenMidiNoteEditor

Example:  
OpenMidiNoteEditor

Opens the [Midi Note Editor](#)<sup>1209</sup>.

### ▼ OpenPageBrowser

OpenPageBrowser

Example:  
OpenPageBrowser

Opens the [Page Browser](#)<sup>881</sup>.

### ▼ OpenRemotelyInput

OpenRemotelyInput

Example:  
OpenRemotelyInput

---

Opens the [Remote Input Tool](#)<sup>[1182]</sup>.

### ▼ **OpenSaveAsFileDialog**

OpenSaveAsFileDialog

Example:

OpenSaveAsFileDialog

Opens the "Save as" dialog in WD to save the current project to a different name and directory.

### ▼ **OpenSMSSettings**

OpenSMSSettings

Example:

OpenSMSSettings

Opens the [SMS Settings Tool](#)<sup>[1219]</sup>.

### ▼ **OpenTrackCamProperties**

OpenTrackCamProperties

Example:

OpenTrackCamProperties

Opens the Track Cam Tool (Beta).

### ▼ **PHAdvServoEnable**

PHAdvServoEnable,ID

Example:

PHAdvServoEnable,1

Enables the Controller for the first Phidget Advanced Servo Motor.

### ▼ **PHAdvServoDisable**

PHAdvServoDisable,ID

Example:

PHAdvServoDisable,1

Disables the Controller for the first Phidget Advanced Servo Motor.

### ▼ **PHAdvServoSetPosition**

PHAdvServoSetPosition,ID,Pos

Example:

```
PHAdvServoSetPosition,2,100
```

Sets the position of the second Phidget Advanced Servo Motor to 100.

### ▼ **PHAdvServoSetVelocity**

```
PHAdvServoSetVelocity,ID,Pos
```

Example:

```
PHAdvServoSetVelocity,1,50
```

Sets the velocity of the first Phidget Advanced Servo Motor to 50.

### ▼ **PHAdvServoSetAcceleration**

```
PHAdvServoSetAcceleration,ID,Pos
```

Example:

```
PHAdvServoSetAcceleration,1,5
```

Sets the acceleration of the first Phidget Advanced Servo Motor to 5.

### ▼ **PHAdvServoSpeedRampingOn**

```
PHAdvServoSpeedRampingOn,ID
```

Example:

```
PHAdvServoSpeedRampingOn,3
```

Enables the Speed Ramping of the third Phidget Advanced Servo Motor.

### ▼ **PHAdvServoSpeedRampingOff**

```
PHAdvServoSpeedRampingOff,ID
```

Example:

```
PHAdvServoSpeedRampingOff,3
```

Disables the Speed Ramping of the third Phidget Advanced Servo Motor.

### ▼ **PHInterface\_0\_16\_16\_EnableScripts**

```
PHInterface_0_16_16_EnableScripts
```

Example:

```
PHInterface_0_16_16_EnableScripts
```

Enables the execution of scripts when the inputs switch on or off.

---

**▼ PHInterface\_0\_16\_16\_DisableScripts**

PHInterface\_0\_16\_16\_DisableScripts

Example:

PHInterface\_0\_16\_16\_DisableScripts

Disables the execution of scripts when the inputs switch on or off.

**▼ PHInterface\_0\_16\_16\_OutputCloseAll**

PHInterface\_0\_16\_16\_OutputCloseAll

Example:

PHInterface\_0\_16\_16\_OutputCloseAll

Closes all digital outputs.

**▼ PHInterface\_0\_16\_16\_OutputClose**

PHInterface\_0\_16\_16\_OutputClose,ID

Example:

PHInterface\_0\_16\_16\_OutputClose,2

Closes the digital output number 2.

**▼ PHInterface\_0\_16\_16\_OutputOpenAll**

PHInterface\_0\_16\_16\_OutputOpenAll

Example:

PHInterface\_0\_16\_16\_OutputOpenAll

Opens all digital outputs.

**▼ PHInterface\_0\_16\_16\_OutputOpen**

PHInterface\_0\_16\_16\_OutputOpen,ID

Example:

PHInterface\_0\_16\_16\_OutputOpen,2

Opens the digital output number 2.

**▼ PHInterface\_0\_4\_4\_OutputCloseAll**

PHInterface\_0\_4\_4\_OutputCloseAll

Example:

PHInterface\_0\_4\_4\_OutputCloseAll

---

Closes all digital outputs of the [Phidget Relay Interface Kit 0/4/4](#)<sup>1234</sup>.

#### ▼ **PHInterface\_0\_4\_4\_OutputClose**

PHInterface\_0\_4\_4\_OutputClose,ID

Example:

PHInterface\_0\_4\_4\_OutputClose,2

Closes the digital output number 2 of the [Phidget Relay Interface Kit 0/4/4](#)<sup>1234</sup>.

#### ▼ **PHInterface\_0\_4\_4\_OutputOpenAll**

PHInterface\_0\_4\_4\_OutputOpenAll

Example:

PHInterface\_0\_4\_4\_OutputOpenAll

Opens all digital outputs of the [Phidget Relay Interface Kit 0/4/4](#)<sup>1234</sup>.

#### ▼ **PHInterface\_0\_4\_4\_OutputOpen**

PHInterface\_0\_4\_4\_OutputOpen,ID

Example:

PHInterface\_0\_4\_4\_OutputOpen,2

Opens the digital output number 2 of the [Phidget Relay Interface Kit 0/4/4](#)<sup>1234</sup>.

#### ▼ **PHIREnable**

PHIREnable

Example:

PHIREnable

Enables the IR Phidget Controller.

#### ▼ **PHIRDisable**

PHIRDisable

Example:

PHIRDisable

Disables the IR Phidget Controller.

#### ▼ **PHIRSend**

PHIRSend,IRAlias

Example:  
PHIRSend,abc

Sends the learned IR Alias code "abc" via the IR Phidget Controller. Please use the [Phidgets IR Receiver / Transmitter Tool](#)<sup>1233</sup> to create these IR Alias.

### ▼ **PHRFIDEnable**

PHRFIDEnable

Example:  
PHRFIDEnable

Enables the RFID Phidget Controller.

### ▼ **PHRFIDDisable**

PHRFIDDisable

Example:  
PHRFIDDisable

Disables the RFID Phidget Controller.

### ▼ **PlaySound**

PlaySound,Filename

Example:  
PlaySound,C:\Coolux\media\instrument.wav

Plays the wave file "instrument.wav" from the specified directory. Please note, that WD does not play another format than wave files.

### ▼ **StopSound**

StopSound

Example:  
StopSound

Stops the currently playing sound that was started via the command [PlaySound,Filename](#)<sup>1424</sup>.

### ▼ **SMPTELinkModeNone**

SMPTELinkModeNone

Example:  
SMPTELinkModeNone

Sets the SMPTE Link Mode to "None", see [Connection Manager](#)<sup>1166</sup>.



### ▼ SMPTELinkModeSend

SMPTELinkModeSend

Example:

SMPTELinkModeSend

Sets the SMPTE Link Mode to "Send", see [Connection Manager](#)<sup>1166</sup>.

### ▼ SMPTELinkModeReceive

SMPTELinkModeReceive

Example:

SMPTELinkModeReceive

Sets the SMPTE Link Mode to "Receive", see [Connection Manager](#)<sup>1166</sup>.

### ▼ SMPTELinkSet

SMPTELinkSet,00:00:00:00

Example:

SMPTELinkSet,00:01:50:10

Sets the SMPTE Link to timecode 00:01:50:10 (hh:mm:ss:ff), see [Connection Manager](#)<sup>1166</sup>.

### ▼ SMSSend

SMSSend,PhoneNumber,Message

Example:

SMSSend,00492211306540,Test

Sends an SMS with the message "Test" to the phone number "00492211306540".

Setup your GSM modem in the [SMS Settings Tool](#)<sup>1219</sup> first to be able to receive and send SMS via the Widget Designer.

### ▼ SMSSendDisable

SMSSendDisable

Example:

SMSSendDisable

When this command is executed, no SMS will be send out. Use the script SMSSendEnable to enable this function again.

Setup your GSM modem in the [SMS Settings Tool](#)<sup>1219</sup> first to be able to receive and send SMS via the Widget Designer.

---

### ▼ **SMSSendEnable**

SMSSendEnable

Example:  
SMSSendEnable

Enables the SMSSend function after it was disabled.

Setup your GSM modem in the [SMS Settings Tool](#)<sup>1219</sup> first to be able to receive and send SMS via the Widget Designer.

### ▼ **OpenSMSSettings**

OpenSMSSettings

Example:  
OpenSMSSettings

Opens the [SMS Settings Tool](#)<sup>1219</sup>.

### ▼ **SystemShutdown**

SystemShutdown

Example:  
SystemShutdown

Shuts down the local WD computer without that you have to confirm it.

### ▼ **SystemReboot**

SystemReboot

Example:  
SystemReboot

Reboots the local WD computer without that you have to confirm it.

### ▼ **SystemLogOff**

SystemLogOff

Example:  
SystemLogOff

Logs off the user of the local WD computer without that you have to confirm it.

### ▼ **TCPStart**

TCPStart,ID

Example:  
TCPStart,1

Starts the TCP Connection with the ID 1, see [Connection Manager](#)<sup>1166</sup>.

### ▼ TCPStop

TCPStop,ID

Example:  
TCPStop,1

Stops the TCP Connection with the ID 1, see [Connection Manager](#)<sup>1166</sup>.

### ▼ TCPSend

TCPSend,ID,Message

Example:  
TCPSend,1,Play

Sends the ASCII message "Play" via the TCP Connection with the ID 1, see [Connection Manager](#)<sup>1166</sup>.

Via TCP-, UDP- and COM Port nodes incoming or outgoing values can be entered as string, decimal or hexadecimal values, see [Syntax TCP-/UDP-/Serial Messages](#)<sup>970</sup>.

Use [d13] to enter a carriage return as a decimal value.  
Use [h0D] to enter a carriage return as a hexadecimal value.  
Use [CR] to enter a carriage return as a ASCII symbol.

For two commands - e.g. a carriage return and a line feed - you may use this syntax: [d13 d10] respectively [h0D h0A] or [CR LF]. Mixed values are also possible, e.g: Example String[CR d10].

### ▼ TCPSendHex

TCPSendHex,ID,Message

Example:  
TCPSendHex,1,48 69 21

Sends the message "Hi!" in hexadecimal values via the TCP Connection with the ID 1, see [Connection Manager](#)<sup>1166</sup>.

See here the [DEC HEX ASCII Table](#)<sup>970</sup>.

### ▼ TCPSendDec

TCPSendDec,ID,Message

Example:  
TCPSendDec,1,72 105 33

Sends the message "Hi!" in decimal values via the TCP Connection with the ID 1, see [Connection Manager](#)<sup>1166</sup>.

See here the [DEC HEX ASCII Table](#)<sup>970</sup>.

### ▼ UDPSendToPort

UDPSendToPort,Port,Message

Example:

UDPSendToPort,32,Play

Sends the message "Play" via UDP to Port 32.

Via TCP-, UDP- and COM Port nodes incoming or outgoing values can be entered as string, decimal or hexadecimal values, see [Syntax TCP-/UDP-/Serial Messages](#)<sup>970</sup>.

Use [d13] to enter a carriage return as a decimal value.

Use [h0D] to enter a carriage return as a hexadecimal value.

Use [CR] to enter a carriage return as a ASCII symbol.

For two commands - e.g. a carriage return and a line feed - you may use this syntax: [d13 d10] respectively [h0D h0A] or [CR LF]. Mixed values are also possible, e.g: Example String[CR d10].

### ▼ UDPStart

UDPStart,ID

Example:

UDPStart,1

Starts the UDP Connection with the ID 1, see [Connection Manager](#)<sup>1166</sup>.

### ▼ UDPStop

UDPStop,ID

Example:

UDPStop,1

Stops the UDP Connection with the ID 1, see [Connection Manager](#)<sup>1166</sup>.

### ▼ UDPSend

UDPSend,ID,Message

Example:

UDPSend,1,Play

Sends the message "Play" via the UDP Connection with the ID 1, see [Connection Manager](#)<sup>1166</sup>.

Via TCP-, UDP- and COM Port nodes incoming or outgoing values can be entered as string, decimal or hexadecimal values, see [Syntax TCP-/UDP-/Serial Messages](#)<sup>970</sup>.

Use [d13] to enter a carriage return as a decimal value.  
Use [h0D] to enter a carriage return as a hexadecimal value.  
Use [CR] to enter a carriage return as a ASCII symbol.

For two commands - e.g. a carriage return and a line feed - you may use this syntax: [d13 d10] respectively [h0D h0A] or [CR LF]. Mixed values are also possible, e.g: Example String[CR d10].

### ▼ UDPSendHex

UDPSendHex,ID,Message

Example:  
UDPSendHex,1,Play

Sends the message "Play" in hexadecimal values via the UDP Connection with the ID 1, see [Connection Manager](#)<sup>[1166]</sup>.

See here the [DEC HEX ASCII Table](#)<sup>[970]</sup>.

### ▼ UDPSendDec

UDPSendDec,ID,Message

Example:  
UDPSendDec,1,Play

Sends the message "Play" in decimal values via the UDP Connection with the ID 1, see [Connection Manager](#)<sup>[1166]</sup>.

See here the [DEC HEX ASCII Table](#)<sup>[970]</sup>.

### ▼ WindowFocus

WindowFocus,WindowTitleText

Example:  
WindowFocus,test.png - Paint

Activates the application with the Window Title Text "test.png – Paint" and sets it into the focus. This command could be very useful if you e.g.. want to send a Keystroke to an application window that is not focused right now (via the command [KeyboardKeyPress.Keycode](#)<sup>[1406]</sup>).

## 17.6.3 PROGRAMMING STATEMENTS

[If else](#) <sup>1430</sup>

[Select Case](#)

[For Loop](#) <sup>1434</sup>

Other advanced script techniques include:

[Variables](#) <sup>1193</sup>

[Member and Session Values](#) <sup>1196</sup>

[Math Expressions](#) <sup>1199</sup>

[Macros](#) <sup>1191</sup>

[Functions](#)

### 17.6.3.1 IF ELSE

As in other programming languages, the if-then-else statement in Widget Designer can be used to program conditional actions. This means, that you may program to perform a certain action if a condition is "true" and another action if it isn't. The result whether something is "true" is based on a comparison of different values, e.g. "is value A bigger than value B?".

- A value can be a number (double, integer) or text (string); it can be a static value e.g. "10" or it can be a [variable](#) <sup>1193</sup> (holding "10").
- The comparison "bigger than" would be expressed with a logical operator ">". Four operators are supported to evaluate whether two values are equal or unequal and in case of a numeric values, if one is bigger or smaller than the other one.
- A entire condition can not only consist of one comparison of two values. It can be extended with a second comparison (of two other values) using the logical "AND" or "OR", e.g. "is value A bigger than value B and at the same time C smaller than D?"
- If a condition is true, the True Script is executed. It starts and ends with curly brackets {} and contains an unlimited number of commands including [Macros](#) <sup>1191</sup>.
- You may decide what happens if the condition is not true. If nothing should take place, the statement simply ends with the curly bracket behind the True Script. If something else should happen, it needs to be announced with the word "Else" followed by the {False Script}

Please note that encapsulated If structures are not supported; neither are encapsulated [For Loops](#) <sup>1434</sup> nor [Select Cases](#) <sup>1432</sup>. It is possible to program them using [Macros](#) <sup>1191</sup>. That means that the True Script executes a macro, and the macro contains another programming statement like if, for, or select. If nested if-else-then statements are needed, programming a case statement result in a much better overview.

## Basic syntax: If A = B

```
If value A Operator value B
{
True Script
}
Else
{
False Script
}
```

### Script Example

This example changes the value of Fader1. The first position is at 128. The second position depends on the [variable](#)<sup>1193</sup> Var1. If Var1 equals 100, the fader goes down after waiting 2 seconds. If the variable is not 100, the fader goes up after 2 seconds. No matter what the second position was, the third position at 64 is set after waiting one second.

```
WDFaderValue,1,128
if Var1 = 100
{
WDDwait,2
WDFaderDown,1,1
}
else
{
WDDwait,2
WDFaderup,1,1
}
WDDwait,1
WDFaderValue,1,64
```

## The available operators

“=” equals  
“>” greater than  
“<” lower than  
“<>” not equal

When writing if statements the values and operators within the condition must be delimited by a blank space character “ ”, other wise the following lines will be executed as regular commands.

## Syntax for advanced conditions: If A = B AND / OR C = D

Logical AND & OR are also possible in order to combine two sets of conditions:

```
If value A Operator value B AND value C Operator value D
{
True Script
}
Else
{
False Script
}
```

Alternatively the syntax could look as following:

```
If value A Operator value B OR value C Operator value D
{
```

```
True Script
}
```

### Script Example

This example changes the value of Fader1. The first position is at 128. The second position depends on the variables Var1 and Var2. Only if Var1 equals the word "Hello" and at the same time, Var2 equals the word "World", the fader goes down after waiting 2 seconds. If the variable is not 100, the fader goes up after 2 seconds. No matter what the second position was, the third position at 64 is set after waiting one second.

```
WDFaderValue,1,128
if Var1 = Hello AND Var2 = World
{
WDWait,2
WDFaderDown,1,1
}
else
{
WDWait,2
WDFaderUp,1,1
}
WDWait,1
WDFaderValue,1,64
```

### 17.6.3.2 SELECT CASE

The select-case statement (also known as switch statement or multi way branches) can be used to program nested if statements more easily and with a better overview. Please refer to the previous chapter [if-then-else statements](#)<sup>1430</sup>.

Basically, the statement starts with looking at a specific [variable](#)<sup>1193</sup>, the so-called "Input Value". It needs to be declared beforehand. The following Cases (i.e command blocks) contain an individual value, the "Case Value". Each Case is evaluated, i.e. it is compared whether the Input Value equals Case Value. If this condition is "true", the Case Script is executed.

The first Case could be "If the above variable equals value A then execute script A". All following Cases would be "If it equals my value then execute my script". The entire select-case statement searches for the Cases whose value equals the Input Value (the above variable) and executes the according scripts.

- A Case Value can be a variable itself.

- A Case Script starts and ends with curly brackets {} and contains an unlimited number of commands including [Macros](#)<sup>1191</sup>.

- The number of Cases is unlimited.

- If there is no True Case (command block containing an equal value), an optional default script can be defined. This block starts with "CaseElse".

Please note that encapsulated If structures are not supported; neither are encapsulated [For Loops](#)<sup>1434</sup> nor other Select Cases. It is possible to program this using [Macros](#)<sup>1191</sup>. That means that the according script executes a macro, and the macro contains another programming statement like if, for, or select.

#### Basic syntax

```
Select Case YourVariable
```

```
Case VariableValue1
{
Value1 Script
}
```



```
Case VariableValue2
{
Value2 Script
}
```

```
Case VariableValueN
{
ValueN Script
}
```

```
CaseElse
{
Default Script
}
```

```
End Select
```

### Script Example

This example is based on the string variable "VarName". It holds the forename of a customer who has logged in before. The idea is, that a Label displays a text with the country, the customer comes from and in addition the Widget Designer calls a page containing regional information and control elements. Three Cases are programmed, one for "Daniel", one for "Rene" and one for "Rajesh". Afterwards, a CaseElse is defined as it is possible that unknown persons log in. In that case, he is routed to a Home Screen and the Label displays "Please register". No matter who is logged in, a variable named "VarStatus" holds the value "1".

```
Select Case VarName

Case Daniel
{
Label1.Text = from Finland
WDPageGoto,Europe
}

Case Rene
{
Label1.Text = from France
WDPageGoto,Europe
}

Case Rajesh
{
Label1.Text = from India
WDPageGoto,Asia
}

CaseElse
{
Label1.Text = Please register...
WDPageGoto,Home
}

End Select
VarStatus = 1
```

Alternatively, the CaseElse block can be eliminated from the statement if it is not needed. Or, the Page "Home" is called at the very beginning of the entire script, even before the main variable is selected. Different solutions are possible and depend on your project.

### 17.6.3.3 FOR LOOP

If you want to repeat a certain script segment several times or based on a time that can change thru a variable then For Loop scripts are ideal to solve such a task efficiently. Here a quick example of how this will look like in a WD script:

```
For 1 to 10

if 1 = 1
{
wdfadervalue,1,128
wdwait,2
}

Wdfaderdown,1,1
WDWait,1.1
Wdfaderup,1,1
WDWait,2

Next
```

This script will execute 10 times the code between the line that start with For and the line that states Next. In order for a For Loop to run, the start count and end count must be typed in by using a delimiting white space character " " and at the end of the For Loop you need to write into a single line "Next". For a count number you may as well use a [variable](#)<sup>[1193]</sup>. If you like to know which cycle is currently active, you may call the member value "for.index", for example, you could insert in the above script:

```
Label1.text = for.index of 10
```

and the label with ID 1 will display "1 of 10", then "2 of 10" and so on.

## 17.7 CHANGELOG

Rev 815 ++++++  
+++++

-WatchFolderToPBPlaylist Clear Watchfolder removes also the Pandoras Box Project entries

Rev 814 ++++++  
+++++

Bugfix

-TrackScan memory leak fixed

Rev 813 ++++++  
+++++

New Pandoras Box Commands (Rev >9999)

"SeqStoreActiveSite,SeqID,SitelD"

"SeqStoreActiveDevice,SeqID,SitelD,DeviceID"

"SeqStoreActiveParameter,SeqID,SitelD,DeviceID,Parameter"

"ShareLayerTexture,SitelD,SourceDevice,TargetDevice"

"ShareLayerTextureByName,SitelD,SourceDevice,TargetDevice,TargetParam"

-Textbox backcolor property added

-New Sticky Notes control added, this allows to add notes and documentation to a page  
the stickynotes are only visible if enable in the menu or by using ALT+N

Bugfix

-Audio input node power peaks fixed

Rev 811 ++++++  
+++++

Feature

-Random Input Node "Refresh" command added

-Label PB Seq readout added

Bugfix

-Function to variable assignment fixed for numeric variables

-Save Video Displays fixed

Rev 810 ++++++  
+++++

Feature

New Commands to send PB Menu Command via dedicated Nic Adapter Name

"PBShutDown,IPAddress,NicAdapterName"

"PBShutDownAll,NicAdapterName"

"PBReboot,IPAddress,NicAdapterName"

"PBRebootAll,NicAdapterName"

"PBStartMaster,IPAddress,NicAdapterName"

"PBStartMasterAll,NicAdapterName"

"PBStartClient,IPAddress,NicAdapterName"

"PBStartClientAll,NicAdapterName"

"PBClose,IP Address,NicAdapterName"

"PBCloseAll,NicAdapterName"

Rev 809 ++++++  
+++++

Bugfix

-TrackScan Input Node comport proceesing mode changed

Rev 808 ++++++

Feature

New Commands

"VGetSeqCueName,VarName,SeqID,CueID" PB Rev 9869 or higher required

"SeqSetCueName,SeqID,CueID,Name" PB Rev 9869 or higher required

"VGetNodeOutputValue,Varname,NodeID,ParamID"

"VArrayGetNodeOutputValue,Varname,NodeID,ParamID"

-TCP input node provides packet data as last output array value

"VArrayGetNodeOutputValue" - Command can be used to retrieve the packet data

-TCP input node "InputUpdate" action added, in order to react with action nodes

on each new valid packet arrival

All Mouse & Touch draw nodes have been updated to support composition modes

0 - Source over - normal drawing

1- Source copy - this allows to draw alpha over existing canvas

Bugfix

-Output node enable pause and mute states shown in userinterface

-Output node enable state stored in project

-Label paste rounding decimal places fixed

Rev 807 ++++++

-"Layer UV Draw To Canvas" alternative Touch Input with ID added

Rev 806 ++++++

Notice

Widget Designer Version changed to 4.7

Bugfix

-Occasional App Crash on Win7 boot with no Keyboard and Mouse attached fixed

Rev 804 ++++++

Bugfix

-Smpte Link re connect fixed

Rev 803 ++++++

Bugfix

- PB Parameter Control Node dialog and save routine fixed

- Midi I/O enable states fixed in connection manager and midi connections

- UDP connection network adapter binding fixed

Rev 802 ++++++

Feature

-New Commands to parse http and json data:

"HTTPRequestToVar,URL,VarName"

"JsonRequestToVar,URL,VarName"

"JsonRequestItemToVar,URL,JsonItem,VarName"

"vGetJsonItem,Variable,JsonString"

Brush

-Com Port input node multipackets set as default

- TCP input node multipackets set as default
- Variable Events optimized

Bugfix

- Com Port inputbuffer handling optimized
- Com Port Tester received message window fixed

Rev 801 ++++++

Feature

- Yaw Pitch Roll Node Camera Roll relative added, this will avoid jumps of > +-180?
- Yaw Pitch Roll Node "ResetCamRollRelative" command added

Bugfix

- Math Expressions for Scripts fixed to support functions like  
 "Min('varA','varB')"  
 "Max('varA','varB')"  
 "Round('varA','varB')"  
 "Pow('varA','varB')"  
 "Floor('varA','varB')"  
 "Ceiling('varA','varB')"  
 "Truncate('varA','varB')"
- Connection Manager SMPTE Link Send mode time entry fixed

Rev 799 ++++++

Feature

- Ember+ node Auto Reconnect added
- Ember+ node Auto IP Nic setup added
- ABB Robot node connection state added
- ABB Robot node prediction & smoothing added

Rev 798 ++++++

Feature

- Ember+ Treeview added to dialog
- Filter node "Camera Yaw Pitch Roll": Extra Point XYZ 3&4 added
- Panasonic PTZ Pan/Tilt as output added, this node is now an Input/Output node

- New Math AB Filter Node, this node allows to do mathematical operations on input parameters
- Math AB Filter Node and Math Expressions for scripts do support if statements like:  
 (A >10) ? 1 : B + 2  
 this is equals to if A > 10 then True = 1 else False = B+2  
<http://msdn.microsoft.com/en-us/library/ty67wk28.aspx>

- New PB Parameter Control Node, this node allows to setup up to 16 individual parameters for one device

Rev 795 ++++++

Feature

- New Ember+ input node, for communication with VSM(Virtual Studio Manager)  
<http://www.l-s-b.de/en/products/vsm.html>

Bugfix

- Functions Array Variable support fixed
- Array member assignment and calculations fixed ("=" "\*" "/" "+" "-=")

Rev 794 ++++++  
+++++  
Bugfix  
-Infinite Loop on PB valuefade fixed

Rev 792 ++++++  
+++++  
Bugfix  
-Possible Thread Lock in CheckVariables fixed

Rev 791 ++++++  
+++++  
Brush  
-Projector Calibration Items Secondary Screen mode added, requires PB Menu Rev 190  
-ID Tag Camera Tracker, Re Acquire Camera button double click prevented

Bugfix  
-Variable Fade Freeze fixed  
-Start Application on systems without audio fixed

Rev 790 ++++++  
+++++  
Bugfix  
-Environment Path Variable gets checked on Widget Startup and cleanedup  
this resolves occasional issues with Path dependencies on "ApplicationStart" scripts

Rev 787 ++++++  
+++++  
Feature  
-"Layer UV Draw To Canvas" node now supports interval time for brush drawing  
New Command: "VGetDeviceMediaName','VarName','SiteID','DeviceID"

Brush  
-All Dialogs updated to default font support for Chinese OS readout  
-"Phidget Stepper Motor" node now support current setting

Bugfix  
-VGetDeviceMediaPath now supports UTF8 strings  
-All load/save dialogs have been updated to not overwrite the current directory anymore  
-Added "ShowEnvironmentVariables" & "WriteEnvironmentVariablesToLog" Command  
for remote debugging purposes

Rev 786 ++++++  
+++++  
Feature  
-ID Tag Tracker Prime13 support added  
-New Optitrack Camera SDK 1.6 Beta added  
For Windows XP Users the following Microsoft update is required:  
Microsoft Visual C++ 2005 Service Pack 1 Redistributable Package MFC Security Update  
<http://www.microsoft.com/en-us/download/details.aspx?id=26347>

Bugfix  
-ID Tag tracker Flex13 masking fixed

Rev 785 ++++++  
+++++  
Feature  
-ID Tag tracker Flex13 camera type added

-Optitrack Visual Test exe added to Widget Root Folder  
-Camera Fov / Focal Length exe added to Widget Root Folder

Bugfix  
-ID Tag Tracker Multi-Threading fixed

Rev 784 ++++++  
+++++

Feature  
New Command:  
"HTTPRequestWithLogin,Username,Password,Message"

Brush:  
-ID Tag Tracker User Interface cleanup

Rev 782 ++++++  
+++++

Feature  
-UnitPerSecond outputvalue added to Distance 1D/2D/3D filter node  
-New Velocity3D Node this node allows to calculate the velocity of an input node with the timebase of input units/second

Rev 777 ++++++  
+++++

Bugfix  
WDControl commands do not fix a control anymore

Rev 776 ++++++  
+++++

Feature  
-New Leuze AMS 308i TCP input node  
-New SACN Input node (Release Protocol only)

Rev 775 ++++++  
+++++

Feature  
-New Technocrane input node (RS232) XYZ Zoom Focus Iris

New Control Scripts:  
"WDControlSetPage,ControlName,Page"  
"WDControlFix,ControlName"  
"WDControlUnFix,ControlName"  
"WDControlSetPosition,ControlName,X,Y"  
"WDControlSetPositionRelative,ControlName,X,Y"  
"WDControlSetSize,ControlName,Width,Height"

Bugfix  
-Calibration Link Input node single calibration module input fixed (must be on bus 1)  
-UDP Ascii Stream Node fixed

Rev 773 ++++++  
+++++

Feature  
-ID Tag Tracker camera mode is maintained when switching between cameras  
-Optitrack re-aquire camera function added, this allows to re-aquire lost cameras or newly connected cameras, this function should be used only during setup.

New Pandoras Box Sublayer Commands (PB Rev >=9740 required):

"AddSubLayerCount,SiteID,DeviceID,Count"  
"SubLayerAssignMediaByID,SiteID,DeviceID,FolderID,FileID"  
"SubLayerAssignMediaByName,SiteID,DeviceID,Path"  
"SubLayerAssignMeshByID,SiteID,DeviceID,FolderID,FileID"  
"SubLayerAssignMeshByName,SiteID,DeviceID,Path"

Rev 772 ++++++  
+++++

Feature  
New SubLayer Commands:  
"AddSubLayer,SiteID,DeviceID"  
"RemoveSublayers,SiteID,DeviceID"  
"SubLayerSetParamDirect,SiteID,DeviceID,SubId,Parameter,Value"  
"SubLayerSetParamSilentDirect,SiteID,DeviceID,SubId,Parameter,Value"  
"SubLayerSetParam,SiteID,DeviceID,SubId,Parameter,Value"

-New SACN UDP input node

Rev 771 ++++++  
+++++

Feature  
-Output node added Phidget Stepper Motor Controller 1067

Rev 763 ++++++  
+++++

Feature  
New Command  
"VGetSubStringTrimStart,'VarName','String','startIndex'"

-Text Crop Filter Node Start Trim Mode added

Rev 757 ++++++  
+++++

Feature  
-Faderfade performance improved  
-New Command: "WDSaveFile,Filename"  
-New Pandoras Bo Resource Command:  
"ResourceRemoveFolder,ProjectPath\  
"ResourceEncodeFile,FileName,Preset"  
"ResourceEncodeFileByID,FolderID,FileID,Preset"  
"ResourceEncodeFileToPath,FileName,TargetPath,Preset"  
"ResourceEncodeFileByIDToPath,FolderID,FileID,TargetPath,Preset"

-Import & Export Nodes added  
-Import & Export Pages added  
-Import Macros added  
-Import Functions added  
-Import Variables added

New CustomScript Commands:  
"WDCustomScriptApplyCITPThumbnail,ID,FolderID,FileID"  
"WDCustomScriptResetCITPThumbnail,ID"

Bugfix  
-Wrong fades on multiple fade starts fixed

Rev 755 ++++++  
+++++



Feature

- Textbox Enter/Return Script added for Single Line Mode
- New Command "WDSaveAsCopy" added

Rev 751 ++++++  
+++++

Feature

- Optitrack Camera node Brightness averaging added to read intensities on laser projectors

Rev 750 ++++++  
+++++

Bugfix

- Panasonic PTZ node load fixed
- Panasonic Absolute tracking mode for Pan and Tilt Only Zoom and Focus disabled

Rev 749 ++++++  
+++++

Feature

"VGetArraySize,VarName,ArrName"

Bugfix

- Optitrack Camera Node camera frame display fixed

Rev 748 ++++++  
+++++

Feature

- Absolute Pan Tilt Tracking added to Panasonic PTZ Camera Control node

Rev 747 ++++++  
+++++

Feature

- Videologger added rounding digits and refresh interval settings
- New "SeqEdit,ID" command, this loads the selected ID into the sequence tab

Rev 746 ++++++  
+++++

Brush

- Array Variables can now accept variables for indices  
ie: MyArr[label1.text] = label2.text  
or: label2.text = MyArr[label1.text]  
in the above two cases the value of label1.text must be numeric to represent an index

Rev 744 ++++++  
+++++

Bugfix

- Imageload store startuppath fixed
- Videosnapshot crash fixed
- CustomScript Networkbroadcasting to same IP fixed
- Click handling on Media Control fixed
- CITP Connection Timeout added
- Camera Tracker memory leak fixed
- Camera Tracker performance improved and proper disposing of high framerate cameras
- Colour Picker webview fixed

Rev 743 ++++++  
+++++

Bugfix

- If Else script statement fixed, that if statements do work without else statment

-ID Tag Tracker Multithreading optimized

Rev 739 ++++++  
+++++

Feature

New Playlist Commands:

- "VGetWDPlaylistTotalCueCount,VarName,ID"
- "VGetWDPlaylistCueMode,VarName,ID,Cue"
- "WDPlaylistSetCueMode,ID,Cue,Mode"
- "WDPlaylistSetAllCueModes,ID,Mode"

New Listview Features

- Added Action listview selected row changed
- Listview drawing updates improved

New Listview Command

- "WDListViewSetColumnName,ID,Col,Name"
- "VGetListViewSelectedRow,Variable,ID"

- New Textbox Control Multi-Line option
- New Textbox Control Length option (maximum characters)

-ID Tag Tracker, ID detection mode changed to be non-camera related  
now the modes determine the maximum IDs per mode and are defined by their Interval

New Porjector Calibration Manager commands:

- "WDProjectorManagerStoreHome,ID"
- "WDProjectorManagerRecalibrate,ID"

Rev 738 ++++++  
+++++

Feature

-ID Tag Tracker High Precision Camera Filtering added, this option is needed in order to enable camera prefiltering of detected segments above threshold, a higher threshold might be chosen for this mode

Rev 737 ++++++  
+++++

Feature

New Playlist Features:

- "VGetWDPlaylistCurrentCueRemainingSec,VarName,ID"
- Action for Playlist changed cue selection added

Bugfix

- Fader Fade performance optimized updates to gui are limited to 40ms
- max 10 fader can be faded at once (visual updates to the gui)

Rev 736 ++++++  
+++++

-ID Tag Tracker processing refactored to support multi-threading, this offers a great performance inprovement for use with multiple cameras

Rev 735 ++++++  
+++++

Feature

-ID Tag tracker optimized prediction algorithm added  
the feature allows to smooth motion jitter and set the prediction in milliseconds in order to compensate signal delays, the prediction now accounts for velocity, acceleration and temporal changes

Rev 734 +++++  
+++++

Bugfix  
-ViewerMode enable/disable commands respect menubar visibility state  
-Edit Page apply on background image from resources fixed

Rev 733 +++++  
+++++

Feature  
-New WD Playlist Cue modes: Continue, Pause & Hold, Pause & FadeOut

Rev 732 +++++  
+++++

Bugfix  
-Relay Node fixed  
-Node connection fixed  
-Netlink Config Module fixed

Rev 731 +++++  
+++++

Feature  
New Variable Fade commands:  
"VFade,Variable,StartValue,EndValue,Time"  
"VFadeTo,Variable,Value,Time"

Bugfix  
-"WDRemoteTCPEnable" fixed  
-Paste Shapes fixed  
-Viewer Mode commands fixed

Rev 730 +++++  
+++++

Feature  
New PB Parameter direct Fade commands:  
"DeviceFadeParam,SiteID,DeviceID,Param,StartValue,EndValue,Time"  
"DeviceFadeToParam,SiteID,DeviceID,Param,Value,Time"

Brush  
-Node connection mode allowed in run and edit mode

Rev 729 +++++  
+++++

Feature  
-OSC Output node custom address field added  
Bugfix  
-Crash on simultaneous fader fades fixed

Rev 721 +++++  
+++++

Feature  
-New Playlist Features and commands  
"WDPlaylistAppendNewEmptyCue,ID"  
"WDPlaylistAppendNewCue,ID,ProjectPath"  
"WDPlaylistAppendNewCueByID,ID,FolderID,FileID"  
"WDPlaylistReplaceCueScript,ID,Cue,Script"  
"WDPlaylistCueName,ID,Cue,Name"  
"WDPlaylistEnableEditing,ID"

"WDPlaylistDisableEditing, ID"  
 "WDPlaylistShowProjectTree, ID"  
 "WDPlaylistHideProjectTree, ID"  
 "WDPlaylistShowButtons, ID"  
 "WDPlaylistHideButtons, ID"  
 "WDPlaylistEnableAutoPauseCues, ID"  
 "WDPlaylistDisableAutoPauseCues, ID"  
 "WDPlaylistSelectCue, ID, Cue"

"VGetWDPlaylistCueMedia, VarName, ID, Cue"  
 "VGetWDPlaylistCueAudio, VarName, ID, Cue"  
 "VGetWDPlaylistCueOverlay1, VarName, ID, Cue"  
 "VGetWDPlaylistCueOverlay2, VarName, ID, Cue"  
 "VGetWDPlaylistCueTime, VarName, ID, Cue"  
 "VGetWDPlaylistCueTimeTotalSecs, VarName, ID, Cue"  
 "VGetWDPlaylistCueName, VarName, ID, Cue"  
 "VGetWDPlaylistSelectedCue, VarName, ID"  
 "VGetWDPlaylistCurrentCue, VarName, ID"

Rev 719 ++++++  
 ++++++

Bugfix  
 -WDPlaylist Resume from skip and Pause fixed  
 -"WDPlayListReplaceCueMedia,..." - ProjectPath must not include the project root name anymore  
 -Layer Draw to Canvas Mouse fixed  
 -UDP/TCP Connection adapter info fixed  
 -Canvas Template Manager Close fixed  
 -Z-ordering optimized on File load

Rev 718 ++++++  
 ++++++

Feature  
 -Support added for nested if/else, select/case and for/next loops  
 -Return value are now fully supported with blocking functions  
 A blocking function is when the result of a function is used as a source of a variable assignment, for example:  
 label1.text = MyFunction{Myvalue}  
 Blocking means that the main gui thread will suspend until the result/return value of the function is reached.

Please note: When using "WDWait" commands inside of blocking functions, this may affect the entire processing of the Widget Designer during runtime.

When a function is used as single statement without its return value being assigned, the execution of the function will be non blocking

-New special commands added to script language:  
 "Break"  
 "Exit For"  
 "Continue For"  
 "Exit Script"

-Script comments are supported by using "" or "/" at the beginning of a line  
 using these special character at the beginning of a line will skip its processing.

-If else, Select Case and For loops are checked for correct syntax,  
 this means that a script will abort executing, for example: if a for loop is missing its "next" statement

- ID Tag Tracker input point processing refined to optimize valid point search for noisy input images(noisy input images should be avoided if possible)
- ID Tag Tracker input smoothing average frame count added

Rev 717 ++++++

Feature

- ID Tag Tracker Double Check Id mode added, this allow to ensure that the correct ID must be detected minimum twice in a row
- ID Tag Tracker Lock Max Motion and Min Distance added, this allows to knock out ids when they are in too close proximity to each other
- Playlist Load Save / Column Width

Bugfix

- Playlist Delete & Edit Partcue fixed
- Playlist Drag Drop Part Cues fixed
- Playlist direct Partcue editing fixed

Rev 716 ++++++

Bugfix

- Panasonic PTZ zoom Focus relative input blocking fixed

Rev 715 ++++++

Feature

- New Node Filter Estimate Affine 3D 4Points added, this node works on 4 XYZ points
- Filter Node Estimate Affine 3D inv Yaw Pitch Roll added

Bugfix

- ID Tag Tracker point leave reset while other ID Tags are still in motion
- ID Tag Tracker point reset when two points are too close to each other

Rev 714 ++++++

Feature

- Filter Node Estimate Affine 3D Rotation Order added

Rev 711 ++++++

Brush

- ID Tag Tracker Lens Calibration enhanced, added Tangential Distortion & Fisheye option

Rev 709 ++++++

Bugfix

- Function Load fixed

Rev 708 ++++++

Feature

- Panasonic PTZ Device relative zoom and focus added
- Panasonic PTZ Device internal Ping added

Rev 705 ++++++

Bugfix

- ID Tag tracking reload error fixed
- "NodelD.ParamID@value.value" fixed
- PB Health node network fix

Notice

-Function used in blocking mode, i.e. for direct assignment via Return statement can not support for loops or if/select case statements at this time.  
 All commands are proceed asynchronously in Widget Desginer in order to not block the user interface and other processes like the node system.

Rev 704 ++++++

Feature

- ID Tag Tracker Origin Mode subpixel accurate keyboard input added  
 Use "arrow" keys for 1/4 Pixel positioning and "enter" key to confirm point
- Move/Edit Mode will not stop node system anymore (only mouse output node)
- New "Pause Nodes" Menu entry, this can be resumed by using the "Run" menu Entry

Brush

-AirScan and Kinect Mouse Emulation will Pause on Move/Edit Mode

Bugfix

-NetLink Nodes IP assignment fixed  
 the NetLink nodes now set their subnetmasks and gateway correctly

Rev 702 ++++++

Brushes

- ID Tag Tracker performance optimizations
- ID Tag Tracker Prime 17 and Prime 41 camera tracking support
- ID Tag Tracker Dialog re-organized
- ID Tag Tracker framerate setting added, this allows to set the framerate for each camera, a frame rate of 100% for USB and 150fps for Ethernet Cameras provides good performance.

Rev 700 ++++++

Feature

-New Functions Tool  
 The function allow to create a subroutines with input variables that can be used for dynamic funtion programming

A function must be declared with the following syntax in the "Function Editor":  
 "FunctionName{arg1,arg2,argN}"  
 The input arguments must be comma separated, n-arguments can be userdefined.  
 The arguments must be written in whole words without comma, period or white spaces  
 The input arguments are temporary variables that are automatically being replaced during runtime by the users input values or variables.  
 The input arguments names can be used in the functions description in the function editor to refer to the input values.

Functions do allow return value by using the following syntax:  
 "Return 'ReturnValue'"

When functions are executed with assignment to a variable like  
 variable1 = function1{10,20}  
 Then the function are executed in sync with the Main GUI,  
 these are so called blocking functions

When functions are executed standalone without assignment of the return value then they are executed asynchronously, non-blockine

Rev 699 ++++++

Feature
-Video Player output node Opacity (Fade to black) added
New Command:
"WVideoSetOpacity,ID,Value"

Brush
-UDP Connections Output Renamed to Target Port

Bugfix
-Create UDP Connection Target/Output Port enable/disable fixed
-TCP UDP connection delete release port fixed
-UDP Ascii Stream output node fixed
-"WLabelStopFlash" on label fix = true fixed

Rev 698 ++++++

Feature
-ID Tag Tracking PB XYZ Swapmodes added

Bugfix
-ID Tag Origin Calibration - Opencv dll not found error on load project fixed

Rev 697 ++++++

Feature
-WDRestart added to File Menu
-ID Tag Tracker unavailable cameras that are not found during camera initialization, are shown in Red in 3D View
-ID Tag Tracker unavailable cameras are marked with [!] in the camera list
-ID Tag Tracking IDs changed from zerobased to 1 based

Rev 696 ++++++

Feature
New Commands to Enable or Disable Ctr+Alt+Delete functionality under Windows
"WindowsDisableTaskManager"
"WindowsEnableTaskManager"
more additional registry infos here:
http://www.northcode.com/blog.php/2007/07/25/Securing-Windows-For-Use-As-A-Kiosk
http://www.sevenforums.com/tutorials/612-secure-logon-press-ctrl-alt-delete-log.html

New Commands to Enable or Disable Alt+F4
"WDDisableAltF4"
"WDEnableAltF4"

Bugfix
-Netlink I/O node DigitalBus2 setrelay fixed
-Remoting TCP/UDP reconnect fixed

Rev 695 ++++++

Feature

-New Panasonic PTZ AW HE60 Output Device Node added  
-Playlist column titles added to edit cue dialog

Bugfix

- Wheel & Encoder NetBroadcast fixed on load

Rev 694 ++++++

Feature

-New Net Link Generic I/O node  
-TCP & COM Script Node now support End Packet Character, for clean packet separation

Bugfix

-Com/UDP/TCP ASCII Stream input nodes now automatically remove any trailing zeros and deal with null-terminated strings  
-TCP / UDP Status Node do update the initial status of connection on create node or change ID

Rev 693 ++++++

Feature

New WD Playlist Commands:  
"WDPlaylistMoveSelectedCueUp,ID"  
"WDPlaylistMoveSelectedCueDown,ID"  
"WDPlaylistShowProperties,ID"  
"WDPlaylistResetJumps,ID"

-Playlist support for editing Media-, Audio- and Overlay-column title names added

-Connection Manager local network adapter setup added

Rev 691 ++++++

Brush

-WatchFolder To Playlist Nodes has added support to cleanup the Playlist on reset

Bugfix

-Added robustness to IP adapter detection on low memory availability  
-Audio Processor Input node zero values fixed

Rev 690 ++++++

Brush

-ID Tag Tracker scroll panel added  
-ID Tag Tracker Warning added on enable/disable Lighting and Aux Tracking

Bugfix

-ID Tag Tracker load of individual camera Origin IDs fixed  
-ID Tag Tracker enable share and join mode fixed

Rev 687 ++++++

Feature

-Artnet Output Network Adapter support added  
-Artnet Input Network Adapter support added

Brush

-Network Broadcasting Settings moved to WD Remoting Dialog



- OSC Output Node changed to send data via UDP Connection
- Added Global Exception Handler
- Added Widget Log File

Bugfix

- ID Tag Tracker re-init ID optimized for 2D and 3D tracking

Rev 686 ++++++

Feature

- WD ULT now support Network adapter choice for PB Connection
- "Use Local IP" checkbox to override project IP is add to PB Connection

- ID Tag Tracker Mask added for S250e cameras
- All Masks for the ID tag Tracker are changed that Black is mask and every other pixel is used for tracking

- Network Adapter Selction for WD Remoting added

Bugfix

- Command strings with "(" fixed if not an array, for example command: ApplicationStart,C:\Program Files (x86)\app.exe
- Encoder Mouse Up image jump fixed
- Internal Portlist optimized applies to all network connections

Rev 684 ++++++

Feature

- WD ULT supports up to 8 Midi Inputs and 8 Midi Outputs
- The Midi Interfaces can be setup in Tools>Midi Connections

New Midi Commands to send data to specific Midi Outputs

- "MidiSendRawMsgByID,ID,Status,Channel,Data1,Data2,Data3"
- "MidiSendNoteOnByID,ID,Channel 1-16,Note C0-G10,Velocity 0-127"
- "MidiSendNoteOffByID,ID,Channel 1-16,Note C0-G10"
- "MidiSendProgramChangeByID,ID,Channel 1-16,Program 0-127"
- "MidiSendControlChangeByID,ID,Channel 1-16,Control 0-127,Value 0-127"
- "MidiSendSysExByID,ID,Data[]"
- "MSCSendByID,ID,DeviceID,Type,Comand"
- "MSCSendByID,ID,DeviceID,Type,Comand,Cue"
- "MSCSendByID,ID,DeviceID,Type,Comand,Cue,CueList"
- "MSCSendByID,ID,DeviceID,Type,Comand,Cue,CueList,CuePath"

Brush

- WebServer Show Root on New project feedback added
- "Save Copy" added

Refactoring

- Internal Create Controls
- Internal Create Nodes
- Internal Midi Devices

Rev 683 ++++++

Brush

- MediaPanel New Highlight Size and Color Property

Rev 681 ++++++

Brush

- Node Highlight on connection
- All "ResourceAdd..." Commands automatically replace "/" to "\" for paths internally
- WDPassword Dialog got a Retry or Cancel Feedback
- Taborder adjusted on most dialogs

Bugfix

- VideoPlayer Fix Option added

Rev 680 ++++++

Bugfix

- Reset PB Connection on New and Project Load
- ContextMenu in Com Connections Dialog fixed
- All damping nodes now round to 3 digits

Rev 679 ++++++

Feature

- ScriptAssist Extended to support double click on MacroNames for direct editing
- ScriptAssist Extended to support double click on VariableNames for direct editing

New Commands:

- "WDCustomScriptMuteClickEnabled,ID"
- "WDCustomScriptMuteClickDisabled,ID"
- "WDCustomScriptMuteClickTime,ID,Time"

- "VGetFilePathFromFileDialog,VarName"
- "VArrayGetFilePathsFromFileDialog,VarName"
- "VGetFileNameFromPath,VarName,Path"

- Math commands now allow to access member values:  
myvariable=Math['fader1.value' \* -1]  
It is important to keep the member value and variable within "" marks

Bugfix

- ScriptAssist close on Mouse click outside of suggested list
- Macros are now sorted
- Variables are now sorted
- Dropdown edit on double click fixed
- Text Reader Input node, fixed wrong behaviour on delete file

Rev 677 ++++++

Feature

New Command

- "WDRestart" -This will close the current Widget Application and launch a new instance

Rev 676 ++++++

Bugfix

- Fader reset Link Fader to empty value fixed
- If and Select Case do not crash on array comparison
- ImageLoader.value fixed
- ArtNetSnapshot.value fixed
- ArtNetRecorder.value fixed

-VideoSnapshot.value fixed

Rev 675 ++++++  
+++++

Bugfix  
-Default Image Settings fixed on File Load and File New  
-WDTextboxAppendText Command variable support fixed

Rev 673 ++++++  
+++++

Feature  
New Filter Node Info  
This node allows to list all source values and get a realtime preview of all output values of a given node. This node is a helper for programming and has no relevance for showmode.

-Hardware Masking added to ID Tag Tracker  
The mask can be setup from Segment mode by blocking all visible segments Or by saving a frame and creating a black and White mask. All pixels that are brighter than 0 in rgb will be masked. This allows to disable specific pixels from being processed by the cameras. This is useful to block pixel zone that cause too much noise or cause errors due to relections etc,..

Bugfix  
-Right-Click switch to Run mode fixed

Rev 672 ++++++  
+++++

Feature  
New PB Playlist Commands:  
"SetPBPlaylistItemDurationByID,Folder,File,ItemID,HH,MM,SS,FF"  
"SetPBPlaylistAllItemDurationByID,Folder,File,HH,MM,SS,FF"

BugFix  
-WatchFolderToPBPlaylist Node ClearWatchFolder fixed  
-ID Tag Tracker 2D Tracking ID Sorting fixed

Rev 671 ++++++  
+++++

Bugfix  
-Scriptassist position fixed on long scripts  
-Node functions fixed

Rev 670 ++++++  
+++++

Bugfix  
-FaderDialog Double to String conversion error fixed

Rev 669 ++++++  
+++++

Feature  
-WebServer Route New Sessions To Index Page  
-New Damping Mean Node

Bugfix  
-Webserver Dialog Checkbox update on load project fixed

Rev 668 ++++++

Feature

New Command:

"PlaySoundLoop,Filename"

Bugfix

- Webserver wrong rederict to index page on control refresh fixed
- Fader link fixed on load

Rev 667 ++++++

Feature

New Command:

"WDCustomScriptSilentReleaseToggleAllBut,ID1,ID2,..."

"WDCustomScriptSilentClickToggleAllBut,ID1,ID2,..."

These commands allow to excluded specific Button IDs

New Excel Command:

"SetExcelCellValue,File,Table,Cell,Value"

Bugfix

- Command "VariableName[ArrayIndex] = value" fixed
- Command "VariableName[ArrayIndex] += value" fixed
- Command "VariableName[ArrayIndex] -= value" fixed
- Command "VariableName[ArrayIndex] \*= value" fixed
- Command "VariableName[ArrayIndex] /= value" fixed

-VideoPlayer Load fixed

Rev 666 ++++++

Feature

-Select Case added to scripts, this statement allows to select different cases to be executed based on a given input value and case value. Use CaseElse to define a default Script if no other case matches the input value

Example Script for a variable with the name ?VarName? holding different values, e.g. ?Tom? or ?Martina?:

Select Case VarName

```
Case Tom
{
  label1.text = from Finland
}
```

```
Case Martina
{
  label1.text = from Germany
}
```

```
CaseElse
{
  label1.text = DefaultText
}
```

End Select

Rev 665 ++++++  
+++++

Bugfix  
-Import for Rev 503 fixed  
-Plugin Nodes import fixed

Rev 664 ++++++  
+++++

Feature  
-Connection Manager Show IP Adapters Dialog added  
-Connection Manager Show used TCP & UDP Ports added

Bugfix  
-Internal Dynamic Variables MyID and MyPage can now be assigned via '='  
-Playlist Hidden PartCue Errors fixed  
-Playlist color Background on Hidden PartCues fixed

Rev 659 ++++++  
+++++

Feature  
-Nic Adapter added for all TCP Connections (WD ULT only), Touch Server,  
PSN Server & ID Tag Server  
Please note: Updating from previous projects requires to reset the Adapter Type

-Nic Adapter option prepared for UDP Connections (WD ULT only) (not yet functional)

Rev 648 ++++++  
+++++

Feature  
-Art-Net Input Node 24bit support added

Rev 645 ++++++  
+++++

Feature  
New Command  
"SystemVolume,'0-100'" (Win7 and later only, not supported for Windows XP)

New Node Commands  
"Node'ID'.ParamID@'Value'  
Example:  
Node1.1@123  
This will assign the value of 123 to Node1 Parameter 1  
Please note that variables are not,"yet", supported for value assignment.

"Node'ID'.ParamID&NodeID',ParamID"  
Example:  
Node1.1&2,1  
This will route ParameterID 1 of Node2 to Node1 Parameter 1

Bugfix  
-OSC Input node now handles OSC bundles as well  
when no filter is set all values will be mapped to the float1-8  
a filter for a value name can also be set

Rev 644 ++++++  
+++++

Feature

-ID Tag Tracker high performance mode added, for ultimate cpu usage

Bugfix

-ID Tag Tracker output values for Lighting and Aux tracking fixed

Rev 642 ++++++

Feature

-ID Tag Swap Mode added, this mode will cause tags to swap their swapids when they are within the swap radius

-ID Tag Share Mode added, this mode will ensure that any other tag takes over the swapid of the Share tag

New ID Tag Node Commands

- "SetShareModeOn, TagID"
- "SetShareModeOff, TagID"
- "SetSwapModeOn, TagID"
- "SetSwapModeOff, TagID"
- "SetSwapID, TagID, SwapID"
- "SetSwapRadius, TagID, SwapRadius"
- "ResetSwapID, TagID"
- "ResetAllSwapIDs"

Rev 641 ++++++

Feature

- New Device Input Node Leica 3D Disto

New Commands:

- "TCPStartAll"
- "TCPStopAll"
- "UDPStartAll"
- "UDPStopAll"

Bugfix

- Load Artnet Output node 24bit settings fixed
- Commands usage ow allows to use space characters with equal sign like "label1.text = fader1.value"
- DeviceSetIP fixed

Rev 634 ++++++

Feature

New Commands:

- "VReplaceNumberByHexCode, VarName, String, Delimter, LeadingZeros"
- "VReplaceAsciiNumberByHexCode, VarName, String, Delimter"

Bugfix

-Command "value =" fixed

Rev 629 ++++++

Feature

- Node Commands are now accessible in Commands and Scripts, ex: "Node1.NodeCommand"
- Node Commands are now automatically listed in ScriptAssist when nodeID. is used, and when WNodeCommand is used

Bugfix

- Playlist show duration on hidden PartCues error fixed
- Optitrack Calibration optimized
- Optitrack Prime41 support added

Rev 628 ++++++

- Feature
- Fader now support enable events for linked faders

Rev 627 ++++++

- Bugfix
- ArtNet Recoder/Player optimized to stay in sync with system clock
  - Playlist dragdrop Subfolder fixed

Rev 626 ++++++

- Feature
- Playlist Auto-Numbering for Part Cues set to 0.001 increment and 3 Digit range
  - Playlist PartCue name changed when PartCues are hidden

- Bugfix
- Playlist wrong title on hidden PartCues fixed

Rev 626 ++++++

- Feature
- Fader LinktoFader property added, this allows a fader to represent the same value as another fader without executing it

Rev 621 ++++++

- Bugfix
- Project save of empty array variables fixed

Rev 616 ++++++

- Feature
- Optitrack Camera Manager added to Connection Manager, in order to use any Optitrack related node the Cmaera manager needs to be turned on.

- ID Tag Config added to Connection Manager

Rev 614 ++++++

- Bugfix
- Art-Net 24bit output fixed

Rev 612 ++++++

- Feature
- ID Tag Tracker Origin settings optimized
  - ID Tag Tracker 3D Marker ID added

- Bugfix
- ID Tag Tracker optimized
  - Load Flipswitches fixed
  - Image Resource Manager delete and assign entries fixed

Rev 611 ++++++  
+++++

Feature

- ID Tag Tracker Hold Frame Count added  
This allows to set a frame count while a marker should be kept active
- ID Tag Tracker Block Frame Count added  
This allows to set a frame count while new Markers will not be detected

Rev 610 ++++++  
+++++

Feature

- ID Tag Tracker added INV XYZ

Rev 609 ++++++  
+++++

Feature

- ID Tag Tracker added Offset XYZ and global Scale

Rev 608 ++++++  
+++++

Feature

- New Watchfolder OInteraction Node Command: "ClearWatchFolder"
- PB Touch Draw To Canvas Node, UV Layer Input added

Bugfix

- Watch Folder Interaction Node fixed
- PB Input Nodes IP filter fixed

Rev 607 ++++++  
+++++

Feature

- Various ID Tag Tracker Node Optimizations
- New OptiTrack Mask To Canvas Node

Bugfix

- ID Tag Tracker Config Dialog Errors fixed
- Memory Leak Canvas Update fixed

Rev 601 ++++++  
+++++

Bugfix

- WD Device input node fixed

Rev 597 ++++++  
+++++

Feature

New Command:  
"AddFileToPBplaylistByID,FileName,ProjectFolder,TempFolderID,TempFileID,PbPlaylistFolderID,PbPlayl  
istFileID"

New Interaction Node

"WatchFolder To PB Playlist"

Rev 596 ++++++  
+++++

Feature

- Canvas Template Manager



-Canvas editing support for Playlist added  
-Playlist Part Cues added

Rev 595 ++++++  
+++++

Feature  
New debugging Command  
"TCPInject,ID,Message"  
"UDPInject,ID,Message"  
"COMInject,ID,Message"  
These Commands allow to emulate an incoming message in order to debug connections and protocols

Rev 594 ++++++  
+++++

Feature  
New StageTech Au:Tour input node

Rev 591 ++++++  
+++++

Feature  
New Commands:  
"DirCopyOverwrite,SourcePath,TargetPath"  
"DirCopyUI,SourcePath,TargetPath"  
"DirCopyBackup,SourcePath"  
"DirCopyChanges,SourcePath,TargetPath"

Bugfix  
-Threading issue resolved with audio input processor  
-Video Player Volume fixed and changed to 0-1 range  
-Video Player Property Window fixed

Rev 589 ++++++  
+++++

Feature  
- New Command:  
"WDFadeToValueSmooth,FaderID,Time,Value"  
"WDFadeToRelativeValueSmooth,FaderID,Time,Value"  
These commands allow the motion to ease in & out, on start and stop of each fade.

Bugfix  
-Fader fade process optimized, flicker reduced on multiple starts

Rev 588 ++++++  
+++++

Feature  
-ID Tag Tracker optimizations, PSN output implemented  
-New Command : "WDNodeProcessOutput,NodeID"

Bugfix  
-Switched to OpenCV lib 2.4.9.1847  
-Akai Apc40 track encoder switching fixed  
-Midi Message Dialog open error fixed

Rev 579 ++++++  
+++++

Bugfix  
-Damping, Delta and Add Relative node are now updating only once per node update cycle

C-amera tracker OpenCV Mode disabled, due to performance issues with the latest OpenCV Libs

Rev 555 ++++++  
+++++

Feature

-All common control property dialogs adjusted to max 600px height

Bugfix

-Condition Node empty input values, leading to WD crash on disconnect node fixed  
-New internal node refernce counter added, this fixed Delta node output values to be consistent when multiple connections request a delta update

Rev 551 ++++++  
+++++

Feature

-PB Touch injection node: New click behaviour added, click on enter, click on leave

Rev 550 ++++++  
+++++

Feature

-New Stage Technologies AU:tour input node

Rev 549 ++++++  
+++++

Feature

-New Node Angle Distance to XY, this is usefull to calculate a XZ position for revolving stages whit a given angle and object distance from the stage center

-New Node Search Dropdown list

-TrackScan Input Node now support relative output values

Bugfix

-TrackScan Com port input fixed

Rev 544 ++++++  
+++++

Feature

-ProBel SWP 08 input node added, this one acts as a Dummy Matrix for communication with VSM Studio

Rev 543 ++++++  
+++++

Feature

Bugfix

-Playlist double click on PLayerbutton fixed

-Playlist highlight cue items fixed

-JogShuttle & FaderBoard release scripts load save fixed

Rev 542 ++++++  
+++++

Feature

-ScriptAssist extended to show item properties after "."

-New Filter node Replace Text

Bugfix

-Leap Motion Node Parameter sorting fixed

-Touch & Mouse injection remap mode will raise a mouse or touch leave event outside of

the remap region

Rev 541 ++++++  
+++++

Feature  
New Command  
"SMSClearList"  
"EmailClearInbox"  
"EmailClearOutbox"

-New Filter Node Text Remove CR LF  
-New Filter Node RegEx Text  
-New Filter Node RegEx Compare Text

Bugfix  
-Node Property Dialog source reload fixed  
-Kinect Enable checkbox fixed

Rev 539 ++++++  
+++++

Feature  
New Commands:  
"ResourceRecordLiveInputByID,FolderID,FileID,FileName,Preset,HH,MM,SS,FF"  
"ResourceRecordLiveInputByIDStart,FolderID,FileID,FileName,Preset"  
"ResourceRecordLiveInputStop"  
"ResourceRecordLiveInput,InputName,FileName,Preset,HH,MM,SS,FF"  
"ResourceRecordLiveInputStart,InputName,FileName,Preset"

"ResourceExportSeq,SeqID,InputName,FileName,Preset,StartHH,MM,SS,FF,StopHH,MM,SS,FF"  
"ResourceCanvasClearByID,FolderID,FileID"

-Camera Tracker -> PB Canvas support added  
-Kinect -> PB Canvas support added  
-Kinect Property Dialog Layout changed

Bugfix  
-Playlist Errors on UP / Down fixed  
-Playlist empty dates fixed  
-Playlist fast double click while playing errors fixed

Rev 538 ++++++  
+++++

Feature  
-New PB Mouse Draw To Canavs Node  
-New PB Mouse Draw Circle To Canavs Node  
-New PB Touch Draw Circles to Canvas Node

Bugfix

Rev 535 ++++++  
+++++

Feature  
-New Video Input Display Node, this node allows to setup 8 region of interest and to measure the average color against a target colour

Bugfix  
-All Node property dialogs have been modified to show only the source nodes id and

parameter names  
-Load ScriptTimers fixed

Rev 532 ++++++  
+++++

Feature  
-Playlist Show/Hide Part Cues add to cue right click menu  
-Playlist Background Device and Color Crossfades added  
-Playlist Show Duration of Part Cues added to Right Click Menu of Cue Items  
-Playlist Filter By Date added

Bugfix  
-Vista Panel Empty Layer size and Pixel Space fixed

Rev 531 ++++++  
+++++

Feature  
-Double click On Variable in variable List allows to edit Variable

Bugfix  
-ResourceSetID fixed  
-Webserver SessionList refresh fixed  
-Move/Edit Mode keeps showing control IDs

Rev 530 ++++++  
+++++

Feature  
New Commands  
"WDLockInterface", \_  
"WDLockGui", \_  
"WDLUnlockGui"

Bugfix

Rev 529 ++++++  
+++++

Feature  
-Commands support direct access to array values,syntax: "variable[index]"  
example: "WDLLabelText,1,test[1]"

-Scripts now support the keyword "MyPage" to allow referencing to the current Page

New Command  
"WDWebServerPublishAllPages"  
"ResourceSetID,ProjectPath,FolderID,FileID"

Bugfix  
-WebServer crash on extensive load fixed  
-CustomScript webclick only in Multi-Session fixed  
-Alphabetical Sorting added to webserver right click entries  
-Move Item To Page list sorted

Rev 525 ++++++  
+++++

Feature  
-New Vista Spyder Touch Panel  
-Vista Spyder Device Node  
New Commands:  
"WDVistaSpyderTouchSetScale,ID,ItemID,Scale"

"WDVistaSpyderTouchSetPos,ID,ItemID,X,Y"

Bugfix

- Page rename fixed
- Control Fix State fixed
- Webserver Refresh pages fixed

Rev 518 ++++++

Feature

- New Queue Command:  
"WDCustomScriptQueueGotoPrevious,ID" - this moves the highlight one step back in the queue  
"WDCustomScriptQueueClickPrevious,ID" - this Command clicks the previous button again

- New Highlight Color For customScript Queues
- Rename of CustomscriptQueues added to dropdownlist in tool dialog

-New Shape Commands

- "WDShapeEnableOutlineCol,ID"
- "WDShapeDisableOutlineCol,ID"
- "WDShapeEnableFillCol,ID"
- "WDShapeDisableFillCol,ID"

Bugfix

- Shape Commands can be entered as RGB or RGBA
- Load encrypted files on load last config fixed
- Camera Tracker Save Mask Fixed for OpenCV Camera Mode

Rev 517 ++++++

Feature

- New Show Running Scripts Dialog added, this tool provides an overview of all currently running scripts, items can be selected and stopped via right click menu

Bugfix

- Vinten D1 Comport error fixed
- Track Scan Comport error fixed
- Com Port input error fixed

Rev 516 ++++++

Feature

- "Find Entry" extended to search in Pages, Nodes and Midi Scripts
- "Fing Entry" right click menu added to navigate to page or open property dialog
- Scripts now support the keyword "MyID" to allow self referencing of the controls sender ID  
example: "WDCustomScriptTint,MyID,255,0,0"  
MyID will refer to the ID of the item that called this script

Bugfix

Rev 515 ++++++

Feature

- "Find Entry In Controls" support double click on found item to open its property dialog

Bugfix

- Fixed mouse & touch injection Re-Map limits
- Webserver input fixed

Rev 514 ++++++

Feature

- Playlist Playmodes and Inpoints added to all items: media, audio overlay 1 & 2  
These settings can be set by right clicking on a playlist cue and go to edit cue
- New "Find Entry In Controls" dialog, this tool allows to search for text entrys in Scripts and texts of all controls

Bugfix

- Keyboard Message Filter changed to support keyboard shortcuts from outside of Widget Designer
- Save project fixed
- Control management refactored

Rev 513 ++++++

Feature

- Playlist Overlay 2 added

Rev 508 ++++++

Feature

- New Command "SystemLock" , this performs a Windows Wokstation Lock
- Playlist Overlay added

Bugfix

- System Log Off on Win7 fixed
- Shape Drawing on Page change fixed

Rev 507 ++++++

Feature

- Playlist copy, paste & cut one or multiple cues, in single / inbetween playlists
- Playlist & CueList painting optimize to reduce flickering during update
- GPS Input Node moved to Input> Device Nodes

Bugfix

- PB project tree load save enabled for playlist and treeviews
- Com Ports input Null Bytes error fixed

Rev 506 ++++++

Feature

- Playlist renumber selected cues added to right click menu of cuelist
- Playlist Show duration of selected cues and duration of playlist as added to right click menu of cuelist
- Playlist new right click menu for cuelist
- Playlist double click on cuelist item for editing

- Playlist shows project tree when Pandoras Box is offline
- Pandoras Box project tree is stored in Widget Designer project

Bugfix

- DropDown array variable source fixed
- Property dialog open in windowed mode fixed

Rev 502 ++++++

Feature

- New Touch & Mouse Injection Remap options, this allows to remap input data to screen

setups with different resolutions and offsets

- Gesture Node Threshold added, to compensate noisy movements and set minimum motion
- Gesture Node Timeout added, this allows to set a minimum motion time in milliseconds
- Scroller Wrap Mode added
- Scroller Multi-Site support added

New Commands:

"WDDropDownListSetItemsFromArray,ID,Variable"

This command allows to fill the dropdown items from an array or a text delimited by '|'

"WDDropDownListSetItemsFromExcel,ID,File,Table,CellStart,CellEnd"

This command allows to readout a range of cells from a column of an excel sheet

"VSetArrayFromTextBox,VarName,TextBoxID"

This will read all lines of a textbox into a string array variable

"VGetAssetDurationHMSByID,VarName,FolderID,FileID"

This will return a text string with in the following format "Hour:Minutes:Seconds"

"PBProjectRefresh" needs to be called before in order to readout the current time

"VGetAssetDurationTotalSecByID,VarName,FolderID,FileID"

This will return the total duration in Seconds, "PBProjectRefresh" needs to be called before in order to readout the current time

Bugfix

- Load project with stopped UDP connections fixed

Rev 501 ++++++

Feature

- New Leap Motion Input node with Remote Touch support

Bugfix

- Control Double-Click switch to Run Mode fixed

Rev 500 ++++++

Feature

- New Output Node Phidget Analog 4 Output (1002\_0)
- New Command: "VGetExcelCellValue,VarName,File,Table,Cell"
- Phidget InterfaceKit 8/8/8 now support SBC with IP and Port
- New Condition Filter Node, this node allows to compare up to 8 differnt input values  
The input values can be numeric or text

Bugfix

- Rename existing page fixed
- Command "WDTextConvertToHorizontalScrollTextPNG" mulitple space fixed

Corrected Commands:

"WDTextInputGotoLine,ID,LineID"

"WDTextInputGotoLineFromTextBox,ID,SourceTextboxID"

Rev 499 ++++++

Feature

- New Relay Link Output Node

Bugfix

- TCP and UDP connection will now clear pending output messages  
This fixes the case that on reconnect old pending messages were sent.
- Fader-, Encoder-, Label-, Textbox-, DropDown- Input Node now load current value of source control on load and apply
- All Openfile dialogs replaced to fix Win7 occasional empty view
- All Savefile dialogs replaced to fix Win7 occasional empty view

Rev 497 ++++++

Feature

- Array Variables now support direct member value access  
example:  
Label1.Text =VarA(7)

Bugfix

- MS Office Excel Support fixed
- Scrollbars fixed

Rev 496 ++++++

Feature

- Art-Net Output can be configured to support different IP Adress Ranges

Bugfix:

- MultiTouch Panel, touch leave event error fixed

Rev 494 ++++++

Notice:

From this revision on imports are only supported for Rev. 411,415,416,487 & 489  
All other Beta Importers have been removed from the application in order to reduce memory overhead. If you need to import any in-between revision please use one of the above revision for import first.

Feature

- Webserver WiiU support
- New WiiU device input node

Bugfix

- Improved Webserver performance and memory usage
- Improved DirectShow Live Video memory usage

Rev 490 ++++++

Feature

- New AirScan Commands  
"WDAirScanEnableTouch"  
"WDAirScanDisableTouch"

New Resource Commands

- "ResourceAddFolder,FolderName"
- "ResourceAddFolderToPath,FolderName,ProjectPath"
- "ResourceAddFolderFromLocalByID,FolderPath,FolderID,FileID"
- "ResourceAddFolderFromLocalToProjectPathByID,FolderPath,ProjectPath,FolderID,FileID"

New Remote Touch Injection into the Widget Remote Input Touch Pipeline

- "WDInjectRemoteTouchDown,ID,X,Y"



"WDInjectRemoteTouchMove,ID,X,Y"  
"WDInjectRemoteTouchUp,ID,X,Y"

Bugfix  
-Plugin Node Copy Paste fixed

Rev 489 ++++++  
+++++

Bugfix  
-Webserver components fixed

Rev 488 ++++++  
+++++

Feature  
-CameraTracker Performance & Memory optimizations implemented

New CommandLine Startup Options  
Start Widget as STD "STARTWDS"  
Start Widget as PRO "STARTWDP"  
Start Widget as ULT "STARTWDU"  
Start Widget as Viewer STD "ViewerMode"

Rev 487 ++++++  
+++++

Feature  
-Custom Colors added to CustomScriptQueue  
New Commands  
"WDCustomScriptQueueShow"  
"WDCustomScriptQueueHide"  
"WDCustomScriptQueueClickPrevious,ID"  
  
-Any Viewer Mode does not require the dongle to be plugged in

Bugfix  
-CustomScriptQueue Execution fixed

Rev 486 ++++++  
+++++

Feature  
New Commands  
"WDVariableToFile,Variable,FileName"  
"WDVariableAppendToFile,Variable,FileName"  
"WDVariableAppendLineToFile,Variable,FileName"  
"WDVariableAppendTimelogLineToFile,Variable,FileName"

Bugfix  
-Script Byte Parser Error fixed (Serial Link Output Node related)

Rev 483 ++++++  
+++++

Bugfix  
-CustomScriptQueue Execution and Dialog Sorting fixed

Rev 478 ++++++  
+++++

Bugfix  
-Com Port re-connection error/crash fixed  
-Optimizations to UDP Connections (Source IP & Port are traced internally)

Rev 477 ++++++  
+++++

Feature

- New Pandoras Box System Menu Check Timer added - Pandoras Box IP Configuration
- New Pandoras Box System Menu Input Node
- New Calibration Link Input Node

Rev 475 ++++++  
+++++

Feature

- New Oculus Rift Input Node, this node provides yaw pitch roll as well quaternion and lens distortion coefficients and eyecenter offsets
- New Node Parameter Output Node, this node allows to set individual node parameter values that are not accessible via input sources

Rev 474 ++++++  
+++++

Feature

- Dropdown array variable support added

-New Command:

- "PBProjectRefresh"
- "VGetAssetMediaWidthByID,VarName,FolderID,FileID"
- "VGetAssetMediaHeightByID,VarName,FolderID,FileID"
- "VGetAssetMediaWidthByName,VarName,AssetName"
- "VGetAssetMediaHeightByName,VarName,AssetName"

Bugfix

- Dropdown variable name case sensivity fixed
- Label variable name case sensivity fixed
- "DeviceSetMeshByName" fixed

Rev 468 ++++++  
+++++

Feature

-New PlaylistScripts:

- "WDPlaylistEnable,'ID'"
- "WDPlaylistDisable,'ID'"

-New Video InputDisplay Commands:

- "WDVideoInputSaveImageAsPng,ID,FileName",
- "WDVideoInputSaveImageAsPngWithSize,ID,FileName,Width,Height",
- "WDVideoInputSaveImageAsPngWithSizeAddToProjectWithID,ID,FileName,Width,Height,FolderID,FileID"

-New Textbpox Script: "WDTextboxFocus,ID"

-New Midi Output Command

- "MidiSendSysEx,Data[]"
- SysEx Message Data Block must start with HF0 and end with HF7

-New Multi-Touch Panel -> PB Touch Injection support added

New CustomScript Queues, this feature allows to visualize sequential relation between buttons.

New Commands

- "WDCustomScriptQueueClickNext,ID"
- "WDCustomScriptQueueReset,ID"

BugFix  
-VideoInputDisplay dispose on application close fixed  
-"DeviceSetMediaByName" fixed  
-RSS Input thread safety optimized

Rev 467 ++++++

BugFix  
-MidiNoteCatch Node fixed, now return channel number 1 based and returns catchedvalue as 0 or 1

Rev 466 ++++++

Feature  
-New MidiNote On/Off Mute Scripts  
"MidiNotesMuteEnable"  
"MidiNotesMuteDisable"

-New Intel Gesture SDK Tracker input node added

Rev 464 ++++++

Feature  
-Labels can now be auto-centered  
-Labels support Rounding of numbers to digit count  
-New Remote Input Tracking, sorting based on source IP with timeouts per item  
-Camera Tracker node width & height added

Bugfix  
-Camera Tracker Mask Load fixed for OpenCV Mode  
-Robustness added to PB <-> WD connection incl auto reconnect optimized  
-Web Server z Order added, currently it is required to save the project in order to initialize all zOrder values for the webserver

Rev 456 ++++++

Feature  
-New Gestures Script node, this node allows to set scripts for single touch swipe up, swipe down, swipe left and swipe right  
-New PB Input Tester Dialog, this tester allows to check for incoming touch and mouse actions from any connected Pandoras Box system  
-Playlist drag drop item up down added  
-Playlist button item up down added  
-New "HTTPRequest,Request" Command, this allows to send single http commands via scripts directly to a webserver

Bugfix  
-Playlist jump fixed  
-Playlist play resume layer flash fixed  
-Playlist overwrite cue fixed  
-Playlist run on hidden page after project load fixed  
-"WdLoadProject" command, leading to empty pages fixed

Rev 455 ++++++

Feature  
-Use Second Hit for PB Touch input, this feature allows to intercept the second layer  
For a example if a transparent layer is in front then the layer picking will iterate

to the next layer in z Order.

Rev 454 ++++++  
+++++

Feature

- New GUI Protection Password Settings, this allows to suppress any editing of the gui via menu or right click actions, use Ctrl+Shift+P to enter and leave that mode.
- TUIO input internal limiter added, to allow only normalized coordinates

Bugfix

- CustomScript touch process fixed

Rev 453 ++++++  
+++++

Feature

- Adjustable size of Touch Overlay Items added

Rev 452 ++++++  
+++++

Feature

- Orientation added to AirScan Multi-Point, Camera Tracker and TUIO input node

Rev 451 ++++++  
+++++

Feature

- TouchOverlay PB Mouse Messages added
- CustomScript PB Mouse Messages added
- CustomScript Touch Drag Enter/Leave Scripts added (same as Mouse Enter/Leave Scripts)
- New Normalize Filter Node added
- New Enable Touch/Mouse Option in PB IP Dialog
- New Invert U/V Coordinates for PB Mouse and Touch in PB IP Dialog

Rev 450 ++++++  
+++++

Feature

- Added PB Screen and PB UV touch Interaction to Custom Script Button and TouchOverlay. This feature allows to react on specific UV Coordinates that were touched in Pandoras Box. The Screen Coordinates represent the 1:1 Pixel Coordinates in Screen Space. The UV Coordinates are translated to the Widget current Width and Height

Rev 449 ++++++  
+++++

Bugfix

- Webserver new iOs support

Rev 448 ++++++  
+++++

Feature

- TouchOverlay added, this feature is available in the Main Gui Properties and allows to visualize inputs from AirScan, Camera tracking, iPhone, Kinect, Remote Input, Tuio,...
- CustomScript support for touch input added, this enables any input like AirScan, Camera Tracker etc to call Mouse click and Release Scripts for any touch item

Rev 446 ++++++  
+++++

Feature

- New Interaction Node: "Mouse Injection", this node allows to inject user mouse interaction into any Pandoras Box client system and dedicated output.

Bugfix

- Colorpicker BG Color fixed and Opacity added
- VNC Panel IP property text selection and paste control fixed
- Stick Line on node connection fixed

Rev 443 ++++++

Feature

- New Tuio Receiver in Connection Manager added
- Tuio Input support for Multi Touch and Motion Mask added
- New Tuio Input Node
- New Interaction Node: Touch Injection, this node allows to inject user interaction into any Pandoras Box client system and dedicated output. Input Data from AirScan, Camera Tracker, iPhone App, Kinect, Remote Input or TUIO input can now be forwarded to a remote Pandoras Box system.

Rev 442 ++++++

Feature

- Fader parameter added "ASIO Master" control
- New text filter nodes to crop text before or after a specific word
- New filter node Delta Threshold, this node allows to reduce jitter of incoming data and offers a timeout to reset itself.
- New Blinking Cursor text filter node, this node can be used to append one or multiple characters as blinking cursor to the input text

Rev 440 ++++++

Feature

New Delta Threshold filter node, this node allows to accept new values that are within a threshold from the last input value

Bugfix

- WD Iphone Remote Image Upload to WD Image Resource Manager fixed (TCP connection required)
- Jogshuttle & Fader Extension Release Scripts fixed
- XY Panel Mouse Over Mode Fixed

Rev 439 ++++++

Bugfix

- RSS Feed local file lock released
- PB Automation update

Rev 438 ++++++

Bugfix

- RSS Feed Timeout for single local files fixed
- Mouse Output Node xy process optimized

Rev 437 ++++++

Bugfix

- Page Password Dialog ignores upper and lowercase
- VNC Reconnect on page change fixed
- Rev430 importer fixed

Rev 436 ++++++

Feature

-New edit tool to move selected items to another page

Bugfix

-Drawing Canvas Load error fixed
-Variable Assignement with spaces fixed

Rev 435 ++++++

Feature

-TCP ASCII Input node extended to support single Head and Tail ASCII Characters
-New Crop Text Filter Node added

Bugfix & Brushes

-Page Enter/Leave Script behavior fixed
-PB Widget Value Device Input node changed to 8 values only
-Project Load Connection timeout of 5sec added
-Page Background image remove fixed
-Empty Playlist Play Pause error fixed
-Playlist feedback if Pandoras Box is not connected added
-SMPTE & DMXLink Reconnect buttons added to connection manager
-New Command for multi-client Tcp Server Connections: "TCPSendToIP, ID, IP, Message"

Rev 434 ++++++

Feature

-GraphDisplay: Line Width & Colour support added

-New Math Expression for Commands

Variable = Math[expression]

Examples:

myValue = Math[12/4]

myValue = Math[sqrt(16)]

Variables can also be used in Math Expressions, by using this notation:

'variable'

Example

myValue = Math[12/'myValue']

The following operators are supported:

Logical:(returns true / false or 1 / 0)

or, ||
and, &&

Relational:(returns true / false or 1 / 0)

=, ==, !=, <>
<, <=, >, >=

Additive

+, -

Multiplicative

\*, /, %(modulo)

The following functions are supported:

Name	Description	
Abs	Returns the absolute value of a specified number.	Abs(-1) = 1
Acos	Returns the angle whose cosine is the specified number.	Acos(1) = 0d
Asin	Returns the angle whose sine is the specified number.	Asin(0) = 0d
Atan	Returns the angle whose tangent is the specified number.	Atan(0) = 0d
Ceiling	Returns the smallest integer greater than or equal to the specified number.	Ceiling(1.5) = 2d
Cos	Returns the cosine of the specified angle.	Cos(0) = 1d
Exp	Returns e raised to the specified power.	Exp(0) = 1d
Floor	Returns the largest integer less than or equal to the specified number.	Floor(1.5) = 1d
Log	Returns the logarithm of a specified number.	Log(1, 10) = 0d
Log10	Returns the base 10 logarithm of a specified number.	Log10(1) = 0d
Max	Returns the larger of two specified numbers.	Max(1, 2) = 2
Min	Returns the smaller of two numbers.	Min(1, 2) = 1
Pow	Returns a specified number raised to the specified power.	Pow(3, 2) = 9d
Round	Rounds a value to the nearest integer or specified number of decimal places.	Round(3.222, 2) = 3.22d
Sign	Returns a value indicating the sign of a number.	Sign(-10) = -1
Sin	Returns the sine of the specified angle.	Sin(0) = 0d
Sqrt	Returns the square root of a specified number.	Sqrt(4) = 2d
Tan	Returns the tangent of the specified angle.	Tan(0) = 0d
Truncate	Calculates the integral part of a number.	Truncate(1.7) = 1

Rev 433 ++++++

Feature

New MagicQScripts:

- "MagicQChannelLevel, ID, Level", \_
- "MagicQJumpToCue, ID", \_
- "MagicQTestCue, ID", \_
- "MagicQUntestCue, ID", \_
- "MagicQTestCueStack, ID", \_
- "MagicQUntestCueStack, ID", \_
- "MagicQRemoteTrigger, State"

Rev 432 ++++++

Feature

-New ScriptTimer Input Node, this node allows to display and use the remaining time of a running timer

New ScriptTimer Commands:

- "WDScriptTimerPause, ID"
- "WDScriptTimerResume, ID"

-New Estimate 3D Transform Node, this node allows to calculate the XYZ Position & Rotation that needs

to be applied to transform 3 Points from one pose to another, it is important for this node that the Pivot Point is located in XYZ 0,0,0

-New UDP Connection Type, "Single Socket Server Client" This connection uses the input port also as output port for outgoing packets, while the standard Broadcast Connection uses any port assigned by the Operating System for outgoing packets

Rev 431 ++++++

Feature

New Script:

- "DeviceSetPreset, SiteID, DeviceID, PresetID1, PresetID2"

Bugfix

- Image Resource Manager Fixed
- Camera Tracker load fixed
- Playlist AudioFiles reload fixed
- UDP Braodcast Connection Load fixed with support for different output ports

Rev 430 ++++++

Feature

- Camera Tracker Motion Mode and factor added, this mode allows to generate input only on motion, once an object does not move anymore the input will be disabled  
the factor represents the factor by which the previous frame is used in the current process

Bugfix

- Jog/Fader Extension precision optimized to 256 steps per fader
- Camera Tracker Load Routine optimized
- Optimization for Widget Designer to be large adressaware, this enables the 32bit WD application to use more than 1 gb of RAM

Rev 429 ++++++

Bugfix

- Tait Navigator input node changed
- Webserver javascript fix

Rev 426 ++++++

Feature

- Security Settings extended to support no password prompt on project save
- Load Project always shows .wdpx and .wdp files by default
- Added option in UDP connection tester to dispaly only last packet

Bugfix

- Import/load rev 416-420 fixed

Rev 425 ++++++

Bugfix

- Webserver activity optimized
- Osc Output Node load/save fixed

Rev 424 ++++++

Feature

- New Tait Navigator Input Node
- New Art-Net Input Node factor & offset settings

Rev 422 ++++++

Feature

- New Project Encryption option to save only encrypted files
- New OSC Output Node

Rev 421 ++++++

Feature

- New ABBRobot input node, builtin for internal tests



- New Yaw Pitch Roll Camera LookAt filter node, this node allows to calculate a PB camera and lookat position as well as Roll angle based on xyz location any yaw pitch roll orientation input
- New Quaternion Camera LookAt filter node, this node allows to calculate a PB camera and lookat position as well as Roll angle based on xyz location any quaternion orientation input
- New RotoZoom Filter Node, this nodes calculates a zoom factor based on the z rotation of an image, this is useful to always fit an image into a rotating output
- New PB Camera Output Node

New Commands:

- "CloseAllDialogs"
- "CloseAirScanProperties"
- "CloseArt-NetMonitor"
- "CloseArt-NetUniverselist"
- "CloseCitpBrowser"
- "CloseConnectionManager"
- "CloseEmailSettings"
- "CloseEventEditor"
- "CloseelpConfiguration"
- "CloseKeyboardShortcuts"
- "CloseKinectDialog"
- "CloseMacroEditor"
- "CloseMidiNoteEditor"
- "ClosePageBrowser"
- "CloseRemoteInput"
- "CloseSmsSettings"
- "CloseVariablelist"

- "OpenTcpConnections"
- "CloseTcpConnections"

- "OpenUdpConnections"
- "CloseUdpConnections"

- "OpenComConnections"
- "CloseComConnections"

- "OpenCameraTrackerDialog"
- "CloseCameraTrackerDialog"

Bugfix

- Find Item checks for Page Passwords
- NBS Send fixed for Encoder
- NBS Send fixed for Wheels
- Imageloader overwrite video option added

Rev 420 ++++++

Bugfix

- Import of Rev 215/248&249 are fixed to support legacy numberstyles
- Load Encrypted project files with security settings set to entire project

Rev 419 ++++++

Bugfix

- Playlist copy paste fixed
- Variables with spaces allowed - tests required!
- Command "ResourceAttachByPath,ProjectPath,SitID,FilePath" fixed

Rev 418 ++++++  
+++++  
Bugfix  
-Playlist Backup Connection Added

Rev 417 ++++++  
+++++  
Bugfix  
-The following commands are now corrected (inverted):  
WDMasterPBTakeoverAllClients  
WDMasterPBBackupMode  
WDBackupPBTakeoverAllClients  
WDBackupPBBackupMode

Rev 416 ++++++  
+++++  
Feature  
-Playlist Sync And Add Media To Project added  
This feature allows to transfer Files to target Sync IPs.  
the "c:\coolux" must be a shared folder on the target IP

Rev 415 ++++++  
+++++  
Feature  
-New Interpolate 1D 2D 3D filter nodes  
-New PB Engine Health node

New Commands:  
"ResourceDetachByPath,ProjectPath,SiteID"  
"ResourceDetachByID,FolderID,FileID,SiteID"  
"ResourceAttachByPath,ProjectPath,SiteID,FilePath"  
"ResourceAttachByID,FolderID,FileID,SiteID,FilePath"

Bugfix  
-Playlist Load/Save Audio Tracks fixed  
-Script Timer Execute on Start / RunOnce conflict with Project save fixed  
-Kinect Ext Node -90° added

Rev 414 ++++++  
+++++  
Bugfix  
-output Variable Node save with no variable assignment fixed

Rev 413 ++++++  
+++++  
Bugfix  
-Kinect Node EXT fix

Rev 412 ++++++  
+++++  
Feature  
New Command:  
"ResourceAddToProjectPath,FilePath,SiteID,FolderID,FileID,ProjectPath"  
Bugfix  
-Rev399 Importer audioprocessor node error fixed

Rev 411 ++++++  
+++++  
Feature  
-New Node Kinect tracker Ext (Beta), with support for pivots velocity and directions

angles of joints and joint connections

Rev 410 ++++++  
+++++

Bugfix  
-Webserver sync pages fixed

Rev 408-409 ++++++  
+++++

Bugfix  
-Media Panel Webserver  
-PageName check

Rev 407 ++++++  
+++++

Feature  
-New Ranges Node, this node allows to output dedicated values for any number of value ranges  
-Phidget RFID IDChanged Action, RFID Tag is available via keyword sendname  
-New Variable PhidgeRFID-Tag  
Bugfix  
-Wheel Actions fixed  
-ScriptTimer Actions fixed  
-Dropdown Actions fixed  
-Multi-Touch Panel Property Dialog PB Layer Scale entry and display fixed  
-Image Resource Manager fixed  
-SerialLink Output Node fixed

Rev 400 - 406 ++++++  
+++++

Bugfixe  
-Webserver internal optimizations

Rev 399 ++++++  
+++++

Feature  
-Audio Processor new EQ Waveform FX support, requires Pandoras Box 5.3 Release with EQ  
Waveform.cfx  
Bugfix  
-Fader copy/paste inverted devices&params paste fixed  
-PB Interaction node mouse input fixed with PB Rev 7748

Rev 399 ++++++  
+++++

Feature  
Bugfix  
-Delete Multiple Items delete page fixed  
-cultureinfo changed to invariant culture, this should resolve all number conversions like german english  
"1.1" to "1,1"  
-Output PB Timecode Node frame text fixed

Rev 398 ++++++  
+++++

Feature  
-New Input Node Pandoras Box Layer Mouse Input

New Page Commands:  
"WDPageBackgroundColor,Page,R,G,B"  
"WDPageBackgroundTopColor,Page,R,G,B"

"WDPageBackgroundBottomColor,Page,R,G,B"  
"WDPagePublishAsWebPage,Page,True/False"  
"WDPageIndexWebPage,Page"  
"WDPageDataRefresh,Page,Interval"  
"WDPageTransparent,Page,True/False"  
"WDPagePassword,Page>Password"  
"WDPageEnablePassword,Page"  
"WDPageDisablePassword,Page"

-New internal Variable "currentpage"

-New mode to add & connect nodes:

Drag connection from a node into empty gui space and the node menu automatically opens and will connect the new node to the last one

-New Multi-Selection sorting by location, this solves the id continuity after paste control operation

-Natural Point input node damping added

-Natural Point input node quaternion prediction built-in for testing

-SensorLink input node E1 & E2 relative values checked for minimum and maximum value,integer min or integer max value

-BlackTrax input node damping added

Bugfix

-Delete Multi-Selection fixed

-Page background colors load fixed for v3.5 project files (Rev 215-249)

Rev 395 ++++++

Feature

New Commands:

"AddEncryptionKey,Key"

"AddEncryptionPolicy,Policy"

Bugfix

-Listview error message fixed

-Listview select row after reload fixed

-Page delete fixed

-PageBackground switch/delete fixed

-ScriptAssist insert text fixed

Rev 394 ++++++

-webserver update

Rev 390 ++++++

Feature

-New property "for.index" added to access for loop current count

New Commands

"DeviceSetMediaInSelection,FolderID,FileID"

"DeviceSetMeshInSelection,FolderID,FileID"

New Listview Properties

Listview1.Value

Listview1.Col

Listview1.Row

Bugfix

-Optimized drawing of multiple fader during fading

Rev 388 ++++++

Note

-X Keys 58 MWII support added new PID

Feature

- Image Resource Manager Supports different Styles and Control Groups

Bugfix

-Color Picker create and load for webbrowser optimized

-Variable Output Node type safety improved

Rev 384-387 ++++++

Bugfix

-Webserver sessionmanagement fixed

Rev 383 ++++++

Feature

-New Kinect Skeleton Tracker Input Node

Bugfix

-CustomScript Mouse Capture -> application freeze fixed

Rev 382 ++++++

Feature

New AirScan Command:

"WDAirScanConnect,IP"

"WDAirScanDisconnect"

-New Layer Circle Align Tool

Bugfix

-Option Dialog node priority reset fixed

-Button default image size reduced to 128x128

-Playlist & Treeview fixed

Rev 381 ++++++

Bugfix

-Variable Load Save optimized and error fixed

-Variable Output Node Save optimized and fixed

Rev 377 ++++++

Feature

- Lock/Unlock Userinterface with Keyboard Ctrl+Pause

New Commands:

"WDLock"

"WDUnlock"

New Listview Commands:

"VGetListViewAverageCol,'Variable','ID','Col'"

"VGetListViewAverageRow,'Variable','ID','Row'"

"VGetListViewSearchUp,VarName,ID,Value,Offset"  
"VGetListViewSearchDwn,VarName,ID,Value,Offset"  
"VGetListViewSearchLeft,VarName,ID,Value,Offset"  
"VGetListViewSearchRight,VarName,ID,Value,Offset"  
"VGetListViewSearchCell,ID,Value,VariableCol,VariableRow"

-Natural Point Input Node extend with predictionfactor and outputvalues for xyz and yaw pitch & roll

New Page Command:

"WDPageSaveAsHTMLtoDir,Page,Directory"  
"WDPageSaveAsHTMLtoRoot,Page"

Bugfix

-Multi-Touch Panel reload fixed  
-WD Remote TCP input multiple commands in one packet fixed for Single Client TCP Server Mode

Rev 376 ++++++  
+++++

Note

-New SplashScreens added

Rev 373 ++++++  
+++++

Feature

-Playlist Crossfade Mode, for alpha channel support  
-Playlist MultiSite/Layer support added  
-Playlist separate AuioTracks and Audio entry per playlistcue  
-Playlist Autoassign Videos with separate audio files, if filenames are equal  
Example: intro.mpg and intro.wav are in the same project folder,  
when intro.mpg gets added to the playlist the intro.wav is automatically assigned to the same cue

-New Generator Node Array Modes:

"Lin"  
"Ramp"  
"RampINV"  
"Sin"  
"Cos"  
"Tan"  
"RND"  
"RND Sin"  
"RND Cos"  
"Switch"  
"Circle"

Bugfix

-Cute Event Delta Fixed  
-Prediction node damping optimized  
-TCP connections force start after multiple stop commands  
-Device Output Node Array Count property  
-TreeView load fixed

Rev 368 ++++++  
+++++

-Added CustomscriptID.Value and added CustomscriptID.sessionvalue  
-Added CustomSriptID.Value changes as input action for action script nodes

New Commands Added:

"WDTextboxAddTextFromSMS,XTBoxID,SMSID"

"WDTextboxAddTextFromLastSMS,TextBoxID"  
"WDPlaylistRefreshTree,ID"

- Added Quaternion Output to Natural Point Tracker Input node
- Changed Yaw Pitch Roll mapping in Natural Point Tracker Input node, Right Handed System must be set to False in Tracking Tools application settings
  - PB X Rotation = Input node Roll
  - PB Y Rotation = Input node Yaw
  - PB Z Rotation = Input node Pitch

-Command ApplicationStart has been extended to support optional commandline arguments  
"ApplicationStart,Filepath,Optional Commandline Arguments"

-New Input Node for Cute Event Control Position Data

Bugfix

- Natural Point Z Pos Delta Calculation Fixed
- ScriptTimer should only run once, not as often as called by scripts
- Color Picker value change Fixed

Rev 366 ++++++  
+++++

Feature

- Device Output Node support array as input and allows to send value to an array of layers based on the Start Site and Device ID
- Random Input Node npw support array output values in order to send multiple random values to a device output node

- Device Output Node now supports No Damping and Silent modes for relative motion
- Added support for the latest Kinesys MultiCast Protocol, Mode2 (legacy mode is still supported with Mode1) - tested with Kinesys version 1.2.219
- Added Pandoras Box Command Upload in IP configuration, this allows to upload the current command set from widget designer to Pandoras Box (if a Widget Device is connected)
- Added Multi-Touch input for Pandoras Box Widget Device input
- Added Input Node PB Layer Touch Input, this allows to process Win7 multi-touch events from any Pandoras Box Client

Bugfix

- Shape radius < 1 fixed
- Dropdownlist property dialog open error fixed

Rev 365 ++++++  
+++++

Feature

- Export To Sequence Node, New "Export Mode by Frame" added, this ensures that when the sequence is being played back during recording that all recorded data samples have a 1:1 timecode relation on export

Rev 363 ++++++  
+++++

Feature

- "itemnameID.sessionvalue.count" added - this return the current count of set session values
- "itemnameID.sessionvalue.clear" added - this will delete all session values for an item

New Shape Command

"WDSShapeCol,ID,R,G,B,A"  
"WDSShapeOutlineCol,ID,R,G,B,A"  
"WDSShapeFillCol,ID,R,G,B,A"

New Treeview Command  
"WDTreeviewRefreshTree,ID"

Rev 359 ++++++  
+++++

Feature  
-Formatted Timecode text output added to PB Sequence Time, Remaining Clip Time and Remaining Cue Time nodes  
- "dropdownID.index" added  
- "itemnameID.sessionvalue.avg" added  
- "itemnameID.sessionvalue.sum" added  
- "itemnameID.sessionvalue.min" added  
- "itemnameID.sessionvalue.max" added

-New Actions added for:  
Textbox, Wheel, Encoder, Dropdown

-Direct value assignment added for (example: "fader1.value = 123")  
textboxID.text  
textboxID.sessionvalue  
faderID.value  
wheelID.value  
encoderID.value  
labelID.value

-Action Script Page Filter added to dialog

Bugfix  
-"KeyboardKeyPress,{SPACE}" support added  
-"dropdown1.text" fixed

Rev 358 ++++++  
+++++

Feature  
-Treeview Background colour added

Bugfix  
-Delete multi-selection form context menu  
-Load/Save Treeview

Rev 357 ++++++  
+++++

Feature  
-Fader Now support inverted Values for different Sequences, Devices and Parameters  
This allows to crossfade different parameters with each other for example, different sofedge curves  
-ScriptTimer new option to execute on start

New Command:  
"WDTextboxReplaceLineEnd,ID,Text"  
This allows to replace line feeds and carriage returns with special characters or space

Bugfix  
-Window move & resize background refresh fixed  
-Load/Save page webrefresh fixed  
-Load/Save multi-session option for Faders Customscripts and Textboxes added

Rev 345  
New Pandoras Box Command:



"ResourceMove,Content,ProjectPath"

This allows to move a content asset within the Pandoras Box Project Tree

"SetAudioMaster,SiteID"

This allows to switch the System Audio Sync Clock to Site

New built-in Variables

"MasterConnectionState"

"BackupConnectionState"

New Textbox Commands

"WDTextboxToFile,ID,Filename"

"WDTextboxAppendToFile,ID,Filename"

"WDTextboxFromFile,ID,Filename"

"WDTextboxAppendFromFile,ID,Filename"

New FileOperation Commands

"FileCopy,SourcePath,TargetPath"

"FileDelete,FileName"

"DirDelete,Path"

"DirCopy,SourcePath,TargetPath"

New ShortCut

-Ctrl+O File Open

-Ctrl+N File New

-Ctrl+Shift+S Save As

Rev 341

-New Tool Phidget InterfaceKit 8/8/8 implemented

-New Commands for Phidget InterfaceKit 8/8/8:

"PHInterface\_8\_8\_8\_Reconnect"

"PHInterface\_8\_8\_8\_Init"

"PHInterface\_8\_8\_8\_ShowDialog"

"PHInterface\_8\_8\_8\_HideDialog"

"PHInterface\_8\_8\_8\_EnableScripts"

"PHInterface\_8\_8\_8\_DisableScripts"

"PHInterface\_8\_8\_8\_OutputCloseAll"

"PHInterface\_8\_8\_8\_OutputClose,ID"

"PHInterface\_8\_8\_8\_OutputOpenAll"

"PHInterface\_8\_8\_8\_OutputOpen,ID"

-New Input Node Phidget InterfaceKit 8/8/8 and Phidget InterfaceKit 0/16/16

-Playlist add treenode on double click

-New Playlist shuffle playmode to play items in random sequence order

-New Playlist Command "WDPlaylistShuffle,ID"

Bugfix

-Multiple UDP Connections with same output Port fixed

Rev 340

Feature

-New Text to QR Code Command

"WDTextConvertToQRCodePNG,File,Text"

This command generates a black&white QR code at 4Pixel Block size

"WDTextConvertToColoredQRCodePNG,Size,R,G,B,A,R,G,B,A,File,Text"

This command allows to specify any colour for fore and background of the QR Code as well as its pixel block size

-New PictureBox command "WDPictureBoxRefresh,ID"  
-FaceTracker Load/Save new params implemented

-New OutputNode "Device Export To Sequence"  
This node provides a data recorder for storage of motion data, the data can later be exported to a Pandoras Box timeline section for further editing.

Bugfix  
-"WDPictureBoxFile,ID,File" store new filename in control fixed  
- Variable Webserver Project Root Init fixed

Rev 339  
-internal optimizations

Rev 338  
-added and edited sessionvalue for controls pages and variable

Rev 336  
Feature  
New Variable Comands  
"Variable = Value"  
"Variable += Value"  
"Variable -= Value"  
"Variable \*= Value"  
"Variable /= Value"

Rev 331  
-Internal refactoring of all GUI control object  
-Fader Wheel & Encoder performance optimization

Rev 324  
Feature  
New CustomScript Commands:  
"WDCustomScriptSilentClick,'ID'"  
"WDCustomScriptSilentRelease,'ID'"  
"WDCustomScriptSilentEnter,'ID'"  
"WDCustomScriptSilentLeave,'ID'"

-Self reference added with reserved words "sendername" and "senderip"

New Commands:  
"WDTextboxConvertToHorizontalScrolltextPNG,'ID','File','Red','Green','Blue','Alpha'"  
This command generates a png file with a specific background color at the size of the font (max 8k x 8k) and removes all CR and LF character to create a single text line.

"WDTextboxConvertToPNG,'ID','File'"  
This command generates a png file from a textbox and renders the entire richtextformat onto a black background

"WDTextConvertToHorizontalScrollTextPNG,Text(),Font(),File,'Red','Green','Blue','Alpha'"  
This command generates a png file with a specific background color based on a single text with a single font  
or accepts string array variables as text and font to support multiple styles and colors  
The font string is described as text string:  
Font: Font/Size/Style/R/G/B/A

Style: Regular,Bold,Italic,Underline or Strikeout  
example: Arial/20/Italic/255/0/0/255

```
"WDTextboxAddTextFromRSSFeed,'TXTBoxID','RSSFeedID"  
"WDTextboxAddTextFromRSSFeedTitle,'TXTBoxID','RSSFeedID"  
"WDTextboxAddTextFromRSSFeedBody,'TXTBoxID','RSSFeedID"  
"WDTextboxTrimEndToTotalCount,'ID','Count"
```

New Page Convert to PNG Commands:

```
"WDPageLabelConvertToPNG,Page,File,Red,Green,Blue,Alpha"  
"WDPageLabelPictureBoxConvertToPNG,Page,File"  
"WDPageLabelPictureBoxConvertToTransparentPNG,Page,File"
```

New Cuelist Command:

```
"WDCueListDeleteCue,'ID','Cue"
```

New Playlist Command:

```
"WDPlaylistDeleteCue,'ID','Cue"  
"WDPlaylistReplaceCue,'ID','Cue','ProjectPath"
```

-Playlist dragdrop and replace with existing item implemented

Bugfix

- Page Delete Fixed
- Page Index automatically set to first entry or default page
- Compare Node > and < fixed
- Send Email with attachment release attchement File access
- Image Resource delete fixed

Rev 323

Feature

- Face Tracker changed to OpenCV

Rev 321

Feature

- New Tool: Array Align Layers

Bugfix

- Fader Input Node ID entry fixed

Rev 320

Feature

- New Menu Bar

Bugfix

- MidiNote mapping fixed
- Phidget IR Save Fixed

Rev 319

Bugfix

- Page Rename Fixed

Rev 318

Feature

- New UDP Data Parser Node, this node allows to parse individual Byte,Integer,Double & String values from an incoming packet  
The node outputs the current value and the delta to the last received packet

## Rev 316

## Feature

- Shape Fill Color added
- New Tree View Control

## Bugfix

- Shape Transparency Fixed
- Shape Loading fixed
- Paste controls after reassigning the IDs could cause an error message, fixed

## Rev 309

## Feature

- Facetracker recognizes multiple faces and the Facetracker input node outputs an active or inactive state

- New Layer Rotation Wrap output node, this node allows to set a Min and Max Angle and Damping Time,

This node automatically resets the output rotation to the range after the damping time is reached.

This useful to map incremental values to a Pandoras Box Rotation parameter with smoothing value (default is 500ms),

when jumping back for example from 360° to 0° the rotation stays smooth

- several optimizations in iNode Interface dll(support for custom dialogs, separate setup Call)

- Multi-Touch Panel Bounce Limits Added

- New Project Password added

- New Project Encryption (AES 256bit) with userdefined password, files are stored as ".wdpx" and can only be opened/decrypted with given password

## Bugfix

- Natural Point Yaw Pitch Roll Conversion fixed
- XY Panel data changed to double precision values for absolute and relative values
- File>New Cancel Button added

## Rev 304

## Feature

- New Pandoras Box Widget Designer Device Input Node
- New Pandoras Box Interaction Input Node
- New Pandoras Box Sequence Timecode Input Node
- New Pandoras Box Clip Remaining Timecode Input Node
- New Pandoras Box Next Cue Remaining Timecode Input Node
- New sorted Node Right-Click Menu and Direct Access Menu with ALT+N

## Rev 304

## Feature

- New Shapes Control (Rectangle Ellips and Round Rectangle outline Shapes can be drawn in the background of any page)

## Bugfix

- double buffered drawing fix for potential error in fader, buttons & pictureboxes

## Rev 298-303

- Switch to new development environemnt

## Rev 297

## Feature

## New Customscript Commands

"WDCustomScriptForceSilentClick,"ID"

"WDCustomScriptForceSilentRelease,"ID"

## Bugfix

- Multitouch Panel Resize fixed (new Panel Region mode added)
- Audio Processor Input Node Dialog FX Dropdownlist fixed entries

## Rev 259

## Feature

## New Action Script Node

- UDP Message input node allows to split input ASCII string without start- and end-bytes to be set (this applies only to UDP packets as UDP packets are never split and are received as whole packet)

## New Variable Scripts

```
"VSetValueFromSplitString,'VarName','String','Separator','Index'"
"VSetArrayFromSplitString,'VarName','String','Separator'"
```

## New Fader Script

```
"WDFadeToRelativeValue,'ID','Seconds','Value'"
```

## Bugfix

- COM/UDP Status input node fixed
- UDP Message output node fixed
- Colour Picker doe not fire internal events on size change and keeps last selected color

## Rev 257

- New Drop Down List input node

## New Drop Down List Commands:

```
"WDDropDownListSetIndex,'ID','Value'"
"WDDropDownListSetText,'ID','Text'"
```

## New Pandoras Box Commands for future use

```
"ResourceBrowserSetURLbyID,'FolderID','FileID','URL'"
"ResourceBrowserSetURLbyName,'BrowserNamePath','URL'"
```

## New Node Commands:

```
"WDNodeEnableOutputAll"
"WDNodeDisableOutputAll"
```

- New Create New Variable Dialog in Variable List right click context menu.
- Variable Input and Output Node dropdownlist with available variables added

## Bug Fix

- Variable output node save array variable fixed (i.e input node is watch folder paths)

## Rev 256

## Feature

- Node Interface Execute Command added

## Rev 255

## Feature

- New DropDownList Control
- New direct script access to member variables of widget designer gui controls

```
DropDownList1.Text
Encoder1.Value
Fader1.Value
Label1.Text
Wheel1.Value
```

```
Time.Year
```

Time.Month  
Time.Day  
Time.DayOfWeek  
Time.DayOfYear  
Time.Hour  
Time.Minute  
Time.Second

Please notice "." characters are not allowed in variable names anymore in order to grant access and avoid conflicts with internal member values

-Added support for Custom Node Plugins  
-TextBox added support for richtext format load & save

New AirScan Commands:

"WDAirScanDamping,Value"  
"WDAirScanMotion,Value"  
"WDAirScanPointIDOffset,Value"  
"WDAirScanTrim,Value"  
"WDAirScanVCount,Value"  
"WDAirScanGap,Value"  
"WDAirScanMaxDelta,Value"  
"WDAirScanXOffset,Value"  
"WDAirScanYOffset,Value"  
"WDAirScanStart,Value"  
"WDAirScanStop,Value"  
"WDAirScanMotionPredictionEnable"  
"WDAirScanMotionPredictionDisable"  
"WDAirScanMotionPredictionFactor,Value"  
"WDAirScanTUIOEnable"  
"WDAirScanTUIODisable"

Changed Commands:

"WDMasterPBTakeoverAllClients"  
"WDMasterPBBackupMode"  
"WDBackupPBTakeoverAllClients"  
"WDBackupPBBackupMode"

Bugfix

-Scrollbar behavior optimized  
-Page Delete fixed, if analog clock control was in use  
-Renumber Control ID -> delete all control -> then re-create control, bug fixed  
This issue could happen on most controls and was throwing an error occasionally.  
-BackGround gradient drawing fixed  
-Playlist renumber fixed  
-Listview fixed  
-XY Panel optimized

Rev 254

Feature

-Label Display Time option added

Bugfix

-ColorPicker redraw fixed  
-Text input node ascii set fixed  
-Text input node first & last line load fixed

Rev 252

Notice

- Project Importers are only available for Rev 215 & 249, older versions must be imported with Rev 215 or Rev 249
- Control Skin Update, new visuals for buttons, faders and many other controls,...
- Text Box and Text Input Control now start with bigger default font

Feature

- ColorPicker Optimized

New Commands:

- "WDColorPickerSetRGB,'ID','Red','Green','Blue'"
- "WDColorPickerSetHSB,'ID','Hue','Saturation','Brightness'"

Bugfix

- Encoder motion fixed

Rev 251

Feature

- PB ParameterList extended with Pandoras Box Camera & Output Parameter Names
- New CustomScript State Input Node
- New Script "WDLoadProject,'File'"
- New Script "WDEnableViewerMode" and "WDDisableViewerMode"
- New Input Node Generator, This node allows to generate SineWave Tan-Wave Linear Waves Circle or Switching Values

Bugfix

- Z-Ordering on project load optimized
- Debug Window Re-Open Fixed
- Graph Display optimization
- Obsolete PBCamtrack.dll and componentes removed, for streamix32 compatibility of PB version 5.1

Rev 250

Feature

- Connection Manager Tuio Highspeed option added
- Changed Tool Menu Entry for TCP/UDP/COM connections
- Background Gradient Color, with support on all controls
- New Control and OutputNode GraphDisplay, this control allows to visualize motion graphs

//

v4.0

//

//

//

V3.5

//

Rev 249 G

Feature

- Added Button Release Scripts for coolux Jog- and Fader Extensions
- Added Button State to Jog/Fader Extension input node

Bugfix

- Fader and Jog Extension fixed click behaviour and driver lockup
- AirScan Motion Damping equals zero error message catched

Rev 249 F

Bugfix

- Phidget IR Save Fixed
- Midi Send Note Script octave offset fixed

---

#### Rev 249 D&E

##### Bugfix

- Output Variable Node Fixed
- VgetFileCount script added support for variables

#### Rev 249 C

- Added Support For Compatibility with Pandoras Box version 5.1 and StreamiX

#### Rev 249

##### Feature

##### New Script:

```
"PHInterface_0_16_16_Init"  
"PHInterface_0_16_16_Reconnect"  
"PHInterface_0_16_16_ShowDialog"  
"PHInterface_0_16_16_HideDialog"
```

- New Fader Extension Input Node

##### Bugfix

- Colour Picker supports 16bit FX Collections
- FaderExtension Dialog Button clicks fixed
- Label Variable Update error on project load fixed
- WDNodeRefreshOutput fixed for Label, Fader, Bargraph, AngularDisplay, DigitalDisplay Outputnode

#### Rev 248

##### Feature

- New debug error logger for scripts, this feature is available for WD PRO only and needs to be Enabled for debug error logging in tool>Options>Debug

##### New Script:

```
"DebugMessage,Message" - this will create a debug entry if debug logging is enabled
```

##### Bugfix

- Variable reload and initialization of system variables fixed
- Damping Timed Node optimized

#### Rev 247

##### Feature

- New "Delay" filter node, this node buffers all numeric input values and outputs them with a timed offset later, the property dialog only updates if output data is generated

- internal update WD PB Device Integration, Script and Values prepared

- Camera Point Tracker, Middle Mouse Button Point 1 Emulation in Camera Preview

- Output Node Enabled/Disabled is displayed in Userinterface on Output Node input Pin

##### New Commands:

```
"DeviceSelect,'SiteID','DeviceID'  
"DeviceUnselect,'SiteID','DeviceID'  
"DeviceAddToSelection,'SiteID','DeviceID'  
"SeqSetTimecodeRelative,'SeqID','HH','MM','SS','FF'"
```

##### New CustomScript Button Commands:

```
"WDCustomScriptImageResource,'ID','ResourceName'  
"WDCustomScriptClickImageResource,'ID','ResourceName'  
"WDCustomScriptMouseOverImageResource,'ID','ResourceName'"
```



"WDCustomScriptImageResourceRange,'StartID','LastID','ResourceName"  
 "WDCustomScriptClickImageResourceRange,'StartID','LastID','ResourceName"  
 "WDCustomScriptMouseOverImageResourceRange,'StartID','LastID','ResourceName"

New System Variables:

"Art-NetInputStatus"  
 "Art-NetOutputStatus"

-Multi-Touch Panel location and size setting added

Bugfix

-Damping timed filter node optimized and linked to output node interval, the property dialog only updates if output data is generated

Rev 246

Feature

-New PB ReConnection Scrip "WDRReConnect", this will reconnect both master and backup with the last IP and Domain  
 -New Audio Processor input node, providing a graphical EQ and direct FX connection to Pandoras Box  
 -New Filter Node Is In Range. This node outputs -1, 0 or 1 to dermine if an inputvalue is < min inside min & max and > max  
 -New Vector Distance 1D/2D/3D filter nodes  
 -New Filter Node Is In Bounding Box. This node outputs if a XYZ Point is inside a Bounding Box, that is defined by its center xyz and width height and depth

New Script:

"ResourceSequenceUpdate,Site,Device,SeqID,H,M,S,F,FolderID,FileID"  
 This allows to exchange a media file at a given time within a running sequence

Bugfix

- AirScan Invalid Point detection improved  
 - Script fix "WDCConnectMaster" renamed to "WDRReConnectMaster"  
 - Script fix "WDCConnectBackup" renamed to "WDRReConnectBackup"  
 - COM/UPD/TCP Input Node delta value error fixed  
 - PB Param Input Node Parameter List updated to switch to PB v5

Rev 245

Feature

-New Prediction Node  
 This node is in particular usefull for motion tracking scenarios, it calculates to following:  $outputvalue = inputvalue + (factor * deltavalue)$

-UDP/TCP/COM Input nodes added Delta Value parameter for numeric input value

-Scroller PB X&Y Offset added

-New Array Variables

New Array Commands:

"VStringArray,'VarName',value1|value2|etc..."  
 "VDoubleArray,'VarName',value1|value2|etc..."  
 "VIntArray,'VarName',value1|value2|etc..."

"VGetArrayValue,'VarName','Index','ArrName"  
 "VSetArrayValue,'VarName','Index','Value"

"VArrayResizePreserve,'VarName','Size"  
 "VArrayResize,'VarName','Size"

"VArraySort,'VarName'"  
 "VArrayReverse,'VarName'"

"VArrayRemoveFirst,'VarName'"  
 "VArrayRemoveLast,'VarName'"

"VArrayAppend,'VarName','Value'"  
 "VArrayPrepend,'VarName','Value'"

"VArrayGetFileNames,'VarName','Folder'"  
 "VGetFileCount,'VarName','Folder'"

New Transparency Commands:

"WDOpacity,'Value 0-1'"  
 "WDTransparencyKey,'R','G','B'"  
 "WDTransparencyKeyOff"

New Art-Net 24bit script

"Art-NetSetVal24bit,'Subnet 0-15','Universe0-15','Channel','Value 0-16.777.215'"

-Art-Net Output node support 24bit output

Bugfix

-SmpteLink Load error messages fixed  
 -First Script delay fixed  
 -Load/Save Fonts fixed GDCharSet, to support special fonts like "Windings"  
 -Save TextNodes cleaned up Carriage Return CR  
 -Fixed Commands for PB Version 5 "DeviceSetParamInSelection,ParamName,AbsoluteValue"  
 -Fixed Commands for PB Version 5 "DeviceSetParamRelativeInSelection,ParamName,RelativeValue"

Rev 244

Feature

New Script:

"OpenVariableList"

Bugfix

-PB Layer v5 Output node Rotation fixed  
 -Backup Connection Functions fixed (double execution of new PB Commands is fixed)  
 -Excel Listview Sum Commands fixed  
 -WD iPhone Remote Accelerometer Conflict with Camera Image transmit resolved  
 -WD iPhone Remote image data send auto updates the image resource dialog  
 -ListView Commands refined  
 -ResourceAddFolderFromLocal fixed  
 -Excel Process Close fixed  
 -Fader fades optimized

Rev 241 / 242

Feature

New Variable Commands:

"VExecuteAsScript,'VariableName'"  
 "VValueRandom,'VarName'"

"VValueDateTime,'VarName'"  
 "VValueDate,'VarName'"  
 "VValueTime,'VarName'"

The Following Commands are useful for formatted Date & Time if these are intended to be used with filenames

"VValueDateTimeF,VarName" - outputs date as "Hour-Min-Second\_Day-Month-Year"

"VValueDateF,VarName" - outputs date as "Day-Month-Year"

"VValueTimeF,VarName" - outputs date as "Hour-Min-Second"

New String Operations on Variables:

"VGetStringLength,VarName,String"

"VGetSubString,VarName,String,StartIndex,Length"

"VGetStringReplace,VarName,String,OldString,NewString"

-"VValue" Script accepts String with comma","

-"VString" Script accepts new values with comma delimiter

New Commands for Camera PointTracker Settings

"WDCameraPointTrackerPoints,Value"

"WDCameraPointTrackerIDStart,Value"

"WDCameraPointTrackerEnableMuteUI"

"WDCameraPointTrackerDisableMuteUI"

"WDCameraPointTrackerEnableAverageColor"

"WDCameraPointTrackerDisableAverageColor"

"WDCameraPointTrackerEnableColorTracking"

"WDCameraPointTrackerDisableColorTracking"

"WDCameraPointTrackerColor,'R','G','B'"

"WDCameraPointTrackerThreshold,Value"

"WDCameraPointTrackerBlur,Value"

"WDCameraPointTrackerInflate,Value"

"WDCameraPointTrackerShrink,Value"

"WDCameraPointTrackerEnableInvert"

"WDCameraPointTrackerDisableInvert"

"WDCameraPointTrackerEnableLookup"

"WDCameraPointTrackerDisableLookup"

"WDCameraPointTrackerEnableMask"

"WDCameraPointTrackerDisableMask"

"WDCameraPointTrackerMinWidth,Value"

"WDCameraPointTrackerMaxWidth,Value"

"WDCameraPointTrackerMinHeight,Value"

"WDCameraPointTrackerMaxHeight,Value"

"WDCameraPointTrackerMaxDelta,Value"

"WDCameraPointTrackerDamping,Value"

"WDCameraPointTrackerEnableMotionPrediction"

"WDCameraPointTrackerDisableMotionPrediction"

"WDCameraPointTrackerMotionFactor,Value"

"WDCameraPointTrackerMotionModeCenter"

"WDCameraPointTrackerMotionModeBottom"

"WDCameraPointTrackerMotionModeTop"

"WDCameraPointTrackerTouchOutResolutionWidth,Value"

"WDCameraPointTrackerTouchOutResolutionHeight,Value"

"WDCameraPointTrackerTouchOutRangeX,Value"

"WDCameraPointTrackerTouchOutRangeY,Value"

"WDCameraPointTrackerTouchOutRangeWidth,Value"

"WDCameraPointTrackerTouchOutRangeHeight,Value"

"WDCameraPointTrackerTouchOutMutePointTime,Value"

"WDCameraPointTrackerTouchOutEnableInX"

"WDCameraPointTrackerTouchOutDisableInVX"  
 "WDCameraPointTrackerTouchOutEnableInVY"  
 "WDCameraPointTrackerTouchOutDisableInVY"  
 "WDCameraPointTrackerTouchOutEnableSwap"  
 "WDCameraPointTrackerTouchOutDisableSwap"  
 "WDCameraPointTrackerTouchOutEnableTUIO"  
 "WDCameraPointTrackerTouchOutDisableTUIO"

-PB Device Output Node now supports the options "No Damping" and "Silent(Inactive)"  
 -Fader Control now supports the options "No Damping" and "Silent(Inactive)"

New Pandoras Box Commands:

"AddVideoLayer,'SiteID','Count'"  
 "AddGraphicLayer,'SiteID','Count'"  
 "RemoveVideoLayer,'SiteID','DeviceID'"  
 "RemoveGraphicLayer,'SiteID','DeviceID'"

"DeviceSetMediaByName,'SiteID','DeviceID','Name'"  
 "DeviceSetMeshByName,'SiteID','DeviceID','Name'"  
 "DeviceSetMediaParamByName,'SiteID','DeviceID','ParamName','MediaName'"  
 "DeviceSetMeshParamByName,'SiteID','DeviceID','ParamName','MediaName'"

"SeqSetCueWaitTime,'SeqID','CueID','HH','MM','SS','FF'"  
 "SeqSetCueJumpTargetTime,'SeqID','CueID','HH','MM','SS','FF'"  
 "SeqSetCueJumpCount,'SeqID','CueID','Count'"  
 "SeqResetJumps,'SeqID','CueID'"

"ResourceAddFileFromLocal,'FilePath'"  
 "ResourceAddFileFromLocalToProjectPath,'FilePath','ProjectPath'"  
 "ResourceAddFolderFromLocal,'Path'"  
 "ResourceAddFolderFromLocalToProjectPath,'FolderPath','ProjectPath'"  
 "ResourceRemove,'Name'"  
 "ResourceRemoveAll"

-New Pandoras Box V5 Base Parameters Layer Output Node, with silent and nodamping option

-New dedicated dialogs for TCP/UDP/COM Connections

-New Options Dialog setting to set the priority of the Node-System

Bugfix

-TCP/UDP/COM Tester Dialogs optimized

Rev 237

Feature

New Commands:

"WDCustomScriptTextFromLabel,'CustomScriptID','LabelID'"  
 "WDCustomScriptAddTextFromLabel,'CustomScriptID','LabelID'"

Bugfix

-Fader fades optimized  
 -Input node Textreader load fixed on empty file  
 -WDControlHide Script fixed for Clock, Media Panel and Textbox  
 -Phidget Encoder Input optimized to support all 4 Inputs  
 -Media Panel Memory Leak fixed that could cause crash

Rev 236

Bugfix

-Application close optimized

Rev 235

Bugfix

-Playlist Commands fixed

Rev 234

Bugfix

-Playlist delete while running fixed

-Resource click on image error fixed

Rev 233

-Playlist AddFolder to PB project optimized

New Commands to control Pandoras Box Device Order

"DeviceBringToFront,SiteID,DeviceID"

"DeviceMoveToFront,SiteID,DeviceID"

"DeviceMoveToBack,SiteID,DeviceID"

"DeviceSendToBack,SiteID,DeviceID"

-New Input Node Phidget Encoder(1047)

BugFix

-Variable Input Node updates output on Apply in its property dialog

-Flipswitch delete fixed

-Label Flash on application close fixed

New Commands

"PHRFIDRecentTagToListView,'ID','Col','Row'\_"

"PHRFIDRecentTagToListViewNewLine,'ID','Col'"

"WDLListViewNewLine,'ID','Col','Value'"

BugFix

-"vadd" for strings fixed

-default variable load on project start and new fixed

Rev 231/232

Feature

-Variable Lock option

New Script:

"VLock,VarName"

"VUnlock,VarName"

-New Playlist (needs Pandoras Box Rev 6477 or higher)

New Commands:

"WDPlaylistPlay,'ID'",\_

"WDPlaylistPause,'ID'",\_

"WDPlaylistStop,'ID'",\_

"WDPlaylistPrevCue,'ID'",\_

"WDPlaylistNextCue,'ID'",\_

"WDPlaylistRenumber,'ID'"

-New Image Resource Manager

-New Image Resource Option for Faders

-New Image Resource Option for CustomScripts

-New Image Resource Option for Image Loader

-New Image Resource Option for Video Snapshots

-New Image Resource Option for Art-Net Recorder

-New Image Resource Option for Art-Net Snapshots  
 -New Image Resource Option for Encoder  
 -New Image Resource Option for Wheels

-WD Remote iPhone/iPad Images are stored as resource

New Commands:

"WDImageLoadResource,'ID','Resource'"  
 "WDImageLoadRecentResource,'ID'"  
 "WDImageSaveFile,'ID','Path'"

"WDRResourceSave,'Resource','Path'"  
 "WDRResourceRecentSave,'Path'"

-New ListView Control, allows to load Excel tables as well as custom table operations (requires Excel to be installed on the System)

ListView Commands:

"WDLListViewUpdateSource,'ID', \_"  
 "WDLListViewSetCell,'ID','Col','Row','Value'"  
 "VGetListViewCell,'Variable','ID','Col','Row'"  
 "VGetListViewSumCol,'Variable','ID','Col'"  
 "VGetListViewSumRow,'Variable','ID','Row'"  
 "VGetListViewSearchUp,'Variable','ID','Value'"  
 "VGetListViewSearchDwn,'Variable','ID','Value'"  
 "VGetListViewSearchLeft,'Variable','ID','Value'"  
 "VGetListViewSearchRight,'Variable','ID','Value'"

-Colour Picker BG updates Page Background  
 -Script Timer BG updates Page Background  
 -Media Panel BG updates Page Background  
 -Encoder BG updates Page Background

-New Compare Node, This node allows to compare to items and output their state 1=' 2'>' or 3'<', as well as an optional other nodes input value as output value

-Updated Analog Clock Control with support for alpha channel  
 -Updated Angular Display Control with support for alpha channel  
 -All Controls Backgrounds optimized for alpha channel support

Bugfix

-Page & Cftp Thumbnail Browser Colordepth fixed  
 -Compare Text Node OutputState always updates its state  
 -Labels are updated on Load and Paste  
 -Output Script node lock save procedure fixed  
 -On File Save all Script Timers and running Macros & Scripts are stopped

Rev 230

Feature

-TCP Connection PingConnection as option for compatibility with ipad socket timeout (must be off for ipad connections)

Rev229

Feature

-Copy/Paste added to Menu

New Commands:

"WDFaderBGImage,'ID','File'"  
 "WDFaderHandleImage,'ID','File'"

---

"WDCustomScriptImage,'ID','File'"  
"WDCustomScriptClickImage,'ID','File'"  
"WDCustomScriptMouseOverImage,'ID','File'"

"WDArtnetSnapshotImage,'ID','File'"  
"WDArtnetSnapshotClickImage,'ID','File'"  
"WDArtnetSnapshotMouseOverImage,'ID','File'"

"WDArtnetRecorderImage,'ID','File'"  
"WDArtnetRecorderClickImage,'ID','File'"  
"WDArtnetRecorderMouseOverImage,'ID','File'"

"WDImageLoaderImage,'ID','File'"  
"WDImageLoaderClickImage,'ID','File'"  
"WDImageLoaderMouseOverImage,'ID','File'"

"WDVideoSnapshotReload,'ID'"  
"WDVideoSnapshotImage,'ID','File'"  
"WDVideoSnapshotClickImage,'ID','File'"  
"WDVideoSnapshotMouseOverImage,'ID','File'"

#### Bugfix

-TrackScan Delta Calculation fixed

#### Rev228

##### Bugfix

-Carriage Return and Linefeed are not stored with Variables in Projectfile

#### Rev226

-Internal Code Cleanup

##### New Commands:

"WDOffsetAllControls,'X','Y'"  
"WDWindowStateNormal"  
"WDWindowStateMaximized"  
"WDWindowStateMinimized"  
"WDWindowSize,'W','H'"  
"WDWindowLocation,'X','Y'"

#### Bugfix

-Phidget Menu Entries are disabled if Phidget Driver is not found  
-Script output node load fixed  
-Custom Script Mute Time applies to Click and Toggle types  
-Viewer Mode shows only File Load & Exit

#### Rev225

##### Feature

-Phidget RFID Dialog Tag ID accessible via Textbox

##### Bugfix

-Script Output Node comparison optimized

#### Rev 224

##### Feature

-Jog & FaderExtension Performance update

#### Rev 223

##### Feature

-Camera Point Tracker MuteUI option for faster Performance during runtime, the camera preview will not be updated then

- Camera Point Tracker Downsample for OpenCV Camera Mode, this will downscale inputs first before processing the images
- Camera Point Tracker OpenCV Mode Refresh Rate can be set as double for slow capturing ie 0.5x per second

## Rev 222

## Feature

- Facetracker output 0 sizes when no face is detected

## BugFix

- Script "VSubtract,VarName,Var1,Var2" Fixed
- Saving Files stops node thread

## Rev 221

## Feature

- New Watch Folder Input Node, this node gets the current filecount in a specified folder
- Commandline Argument to enable the Kinect for XP Systems (this is built-in for tests only) Args: "XPEnableKinect"

## Bugfix

- WDPagechange lowercase names corrected
- Variable Dialog optimized for highspeed updates
- NodeID in scripts from numeric variables fixed

## Rev 220

## Bugfix

- If Else respects string comparison via '='

## Rev 219

- New Videologger Tool (Pro version Only)

## New Videologger Commands:

- "WDVideologgerStart"
- "WDVideologgerStop"
- "WDVideologgerAddComment,'Comment'"
- "WDVideologgerAddMediaComment,'Comment'"
- "WDVideologgerAddDevice,'SiteID','DeviceID','MinOpacity'"
- "WDVideologgerClearDevices"
- "WDVideologgerClearlog"
- "WDVideologgerSave,'Path'"

## New Variable Get Commands:

- "VGetDeviceParam,'VarName','SiteID','DeviceID','ParamName'"
- "VGetDeviceMediaFolderID,'VarName','SiteID','DeviceID'"
- "VGetDeviceMediaFileID,'VarName','SiteID','DeviceID'"
- "VGetDeviceMediaPath,'VarName','SiteID','DeviceID'"
- "VGetDeviceObjectFolderID,'VarName','SiteID','DeviceID'"
- "VGetDeviceObjectFileID,'VarName','SiteID','DeviceID'"
- "VGetDeviceObjectPath,'VarName','SiteID','DeviceID'"

## Rev 218

- New Natural Point NatNet Input node for Marker, Trackable & Rigid Body tracking
- New Camera Point Tracker Create Mask option, creates an inverted mask from the current preview image, this allows to block out all currently visible regions.

## Bugfix

- Collision Panel Loading fixed

## Rev 217

## Feature



-FlirCamera implemented as Runtime Plugin  
-New Script-Plugin Model implemented for Third Party Runtime Script Plugin Development (.dll)

-Output Script Node Gui Delay On/Off added

#### Bugfix

-Output Script Node improved  
-WdWaitCancelItem supports cancelation of node scripts like script output wait times  
-ColorPicker load parameters fixed

#### Rev216

##### Feature

-Output Artnet Node allows 16bit channel swapping

#### New Wheel Commands:

```
"WDWheelFadeUp,'ID','Value"  
"WDWheelFadeDown,'ID','Value"  
"WDWheelFadeToValue,'ID','Time','Value"  
"WDWheelAbortAllFades"  
"WDWheelAbortFade,'ID'"
```

-Mediapanel last selection highlight changed to blue

-Camera Point Tracker loading optimized  
-Camera Point Tracker min size 0 enabled  
-Camera Point Tracker drawing optimized  
-Camera Point Tracker active point count display  
-Camera Point Tracker Motion Prediction optimized Point Enter

-AirScan Motion Prediction optimized Point Enter

-AirScan Setup Pick & Draw Active Region implemented

#### New CustomScript Script:

```
"WDCustomScriptTint,'ID','Red','Green','Blue"  
"WDLabelTextSubString,'LabelID','StartIndex','Length'"
```

#### Bugfix

-Camera Point Tracking Load Mask fixed. Mask Size detection for DirectShow Cameras fixed.

#### Rev 215

##### Bugfix

-Angle To Point Node Location entry fixed  
-Error on Application Close fixed

#### Rev 214

##### Bugfix

For Loops fixed  
IF statements fixed

#### Rev 213

##### Feature

-New Filter Angle Distance node, this nodes calculates the distance and angle in between two given points

#### New Commands:

```
"ApplyView,'ViewID"  
"SpareFromSpread,'SiteID'"
```

"IncludeInSpread,'SiteID"

"ResourceResize,'Path','Width','Height'" - This will change the pixel size of the specified imagefile (bmp/jpeg/png)

-Camera Point Tracker Interface Changed (Camera Preview is now native 640x480 for faster display)  
-For This Revision ONLY!'Custom Camera FLIR SC 655 added (only available in Camera Point Tracker, if custom features are enabled)

Bugfix

-Page Edit with same Name fixed  
-Mute Node on Page Change on Node Copy fixed  
-Camera Point Tracker Input Node Load fixed

Rev 212

Bugfix

-Phidget Manager warning suppressed

Rev 211

Bugfix

-Excel Output node stores and reads multi-line strings  
-Art-Net Set Universe optimized

Rev 210

Feature

-Camera Tracker Frame Capture added  
-Camera Tracker Load & Use Mask added  
-AirScan View Range drastically enlarged for large scale scanning regions

New Commands

"WDCustomScriptSilentClickTogglePage,'PageName'", \_  
"WDCustomScriptSilentReleaseTogglePage,'PageName'", \_

New ArtNetSnapshot Commands

"WDArtNetSnapshotStopFade,'ID'"  
"WDArtNetSnapshotStopAllFades"  
"WDArtNetSnapshotClear,'ID'"  
This resets the Stored ArtNet/DMX values to zero

"WDArtNetSnapshotHTPMerge,'ID','Subnet','Universe'"

Highest value Takes Precedence merge of an existing Output Universe with the stored ArtNet Snapshot Universe

Bugfix

-Check for Phidget Manager on Open Phidget Dialogs implemented to avoid crashes  
-Camera Tracker prediction optimized  
-Air Scan tracking & prediction optimized

Rev 209

Feature

New Commands:

"WDConnectBackup,IP,Domain"  
"WDMasterEnableBackup"  
"WDMasterDisableBackup"  
"WDBackupEnableBackup"  
"WDBackupDisableBackup"

-Camera Tracker supports now any camera resolution and highframerates (60fps cameras)

---

- Camera Tracker Calibration Lookuptable implemented
- Camera Tracker Motion Prediction implemented

- AirScan Motion Prediction implemented

- Custom Output Node added Realfiction-3DStack

Bugfix

- DrawingCanvas Crash fixed
- Crash of Colour Picker fixed
- Encoder double precision values input fixed
- Label output node removes Null characters
- Phidget 0/0/4 & 0/16/16 info button caught
- WDFilePath and WDFilename Variables are now updated on each save project action
- Art-Net Snapshot fading optimized

Rev 208

Feature

- Camera Point Tracker TUIO Output Mode added
- New Remote Touch Input Node

Bugfix

- Scripts Fixed, empty lines were ignored and script was not executed

Rev 207

Bugfix

- Camera Tracking Memory Management optimized

Rev 206

Bugfix

- Multitouch Panel V5 Rotation Mode fixed
- Collision Panel V5 Rotation Mode fixed

Rev 204/205

Bugfix

- WDFadetoValue Script, accepts double precision values
- WDPasswdDialog fixed

Rev203

Feature

- New Version 5 Parameter Value support added,  
Mode can be changed in IP Configuration

- Fader supports double precision values
- Wheel supports double precision values
- Encoder supports double precision values
- Motion Mask optimized for Touch input

Bugfix

- Script: "SeqSetNextCuePlayMode,'SeqID','Play/Pause/Stop/Jump/Wait'" Fixed

Rev202

Feature

- New Script:"WDArtNetSnapshotActivateAllFade,'ID'"  
This script does not stop concurrent fades of other running Art-Net snapshots,  
this script is useful when multiple snapshots run on different Art-Net universes
- New Script: "WDTextboxAppendTextOnly,'ID','Text'"  
This script ignore variable names in the Textinput field

## Bugfix

- TrackScan optimized
- Fader Out of range values caught
- Filter Damping Node min 0.01 max 1.0 values caught

## Rev201

## Feature

- New Script: "PBSaveProject"
- Images changed to "PictureBox" . old scripts are still supported
- New Scripts:
  - "WDPictureBoxFile,'ID','File', \_
  - "WDPictureBoxScreenshot,'ID', \_
  - "WDPictureBoxScreenshotRegion,'ID','X','Y','Width','Height'", "", \_
- New Phidget Relay interface 0/0/4
- Phidget Interfaces must be started with their unique Serial Number
- New Scripts:
  - "PHInterface\_0\_0\_4\_OutputCloseAll"
  - "PHInterface\_0\_0\_4\_OutputClose,'ID'"
  - "PHInterface\_0\_0\_4\_OutputOpenAll"
  - "PHInterface\_0\_0\_4\_OutputOpen,'ID'"

## Bugfix

- Changelog is now always loaded correctly
- Remote Touch Interface load save fixed
- Remote Touch Client potential Memoryleak fixed

## Rev200

## Feature

- New Cue Generator Tool
- New Tool Add Graphic Layers (Pandoras Box V5 Only)
- IF Else statements for Scripts added: Operators "=" ">" "<" "<>"
  - "if a > b
  - {
  - 'True Script'
  - }
  - else
  - {
  - 'False Script'
  - }"
- Logical IF Else combinations added, Logical Operators: "AND" / "OR"
  - "if a > b AND c = d
  - {
  - 'True Script'
  - }
  - else
  - {
  - 'False Script'
  - }"
- For Loops for Scripts added, these loop allow to repeat specific script code based on fixed numbers or dynamic variables
  - "For 1 to 10
  - 'Script'
  - Next
  - "
- New Script "WDMultiTouchBringToFront,'ID', 'ItemID'"
- New Page Scripts:
  - "WDPageExecuteEnterScript,'Pagename'"
  - "WDPageExecuteLeaveScript,'Pagename'"

## New System Scripts:

"SystemReboot"

"SystemLogOff"

## New Webbrowser Script updates

"WDWebBrowserContent,'ID','Uri'"

"WDWebBrowserClearCache"

## Bugfix

-Cuetimer multiple day calculation fixed

-KeyboardShortcuts with open dialogs fixed

-Label flash option stop in label dialog fixed

## Rev199

## Feature

## New Script:

"WDLabelTextTrimStart,'ID','Count'"

## Bugfix

-Collisionpanel friction values over +1 caught, only value below 1 are allowed

-Collisionpanel Auto set device numbers fixed

-Collisionpanel Propertydialog layout optimized

-Scroller Script events fixed for snap mode

-WDWait script fixed

## Rev198

-Error Message added on USB Serial Port unplugged in order to warn the user that the project must be saved and WD must be restarted

-Memory optimizations for Kinect processing

-PB Parameter updates for multiple devices from fader control and Behringer midi boards optimized

## Rev197

## Feature

## New Scripts:

"WDArtNetSnapshotCapture,'ID'"

"WDArtNetRecorderStart,'ID'"

"WDArtNetRecorderStop,'ID'"

"WDCueTimerStart,'ID'"

"WDCueTimerStop,'ID'"

"SeqDeleteAllCues,'SeqID'"

"SeqDeleteCue,'SeqID','CueID'"

"SeqAddPlayCue,'SeqID','CueID','hh','mm','ss','ff','Name'"

"SeqAddPauseCue,'SeqID','CueID','hh','mm','ss','ff','Name'"

"PBFaderMap,'FaderID','SeqID'"

"PBCueMap,'ButtonID','SeqID','CueID'"

"DeviceSetParamDirect,'SiteID','DeviceID','ParamName','AbsoluteValue'"

"DeviceSetParamSilent,'SiteID','DeviceID','ParamName','AbsoluteValue'"

"DeviceSetParamDirectSilent,'SiteID','DeviceID','ParamName','AbsoluteValue'"

"WDMemoryCleanup" - System Script to manually cleanup .net memory and run the memory garbage collector

## New built-in system variables:

"WDFilePath"

"WDFilename"

These are automatically updated on each project load or import

All TCP Client and Servers constantly check the availability of the corresponding Client or Server via Ping every 5sec

This increases the robustness of TCP Server Client connections especially on hardware failure or lost cable connection

WD TCP Remoting Optimized for Single and Multi Client Mode

New Options Dialog with detailed settings for the node execution time intervals, this allows to affect and

improve the performance of the node system

Bugfix

- MidiMessageScripts are properly cleared on project load
- CollisionPanelPropertyDialog PB X&Y Offset & Factor fixed
- CollisionPanelPropertyDialog Displaymode readout fixed
- Excel Writer fixed
- Eventviewer Refreshes on new Event Added
- Kinect start device fixed on import and project load
- Collision Panel X&Y Offset and Factor fixed
- Multi Touch Panel X&Y Offset and Factor fixed
- TextBox Property Dialog color load fixed
- TCP ASCII Stream output node now support full strings
- On save dialog open all other open dialogs are closed
- MediaPanel remove devices empty slot is correctly handled
- Topmost dialogs are recovered on switching back to WD and clicking on the empty gui
- Output Script node updates min every 200 ms (this reduces locks of the gui and possible memory leaks)

Optimizations

- Threadafety improved on application close and output node thread end
- First Chance of exceptions on start and close fixed

Rev196

Feature

New Scripts:

- "WDControlBringToFront,'ControlName'"
- "WDControlSendToBack,'ControlName'"
- New Excel Writer Output Node

Rev195

- Collision Panel refined (load save added)

Rev194

Bugfix

- fixed issue on project close, while scripttimer was still running

Rev 193

Feature

- MultiTouch Panel PB X&Y Factor added, this way multi screen setup can be scaled up easily on each axis

Bugfix

- If no icon is specified in project file, then the default icon is applied
- Phidget Interfacekit optimized
- PrintScripts optimized for Win7 Classic theme

Rev 192

Feature

New Script: "WDVideoGotoTimeRelative,'ID','Second'"

Snap-setting is saved in project

New Phidget Interfacekit 0/16/16 implemented

New Phidget Interfacekit 0/16/16 scripts

"PHInterface\_0\_16\_16\_EnableScripts"

"PHInterface\_0\_16\_16\_DisableScripts"

"PHInterface\_0\_16\_16\_OutputCloseAll"

"PHInterface\_0\_16\_16\_OutputClose,'ID'"

"PHInterface\_0\_16\_16\_OutputOpenAll"

"PHInterface\_0\_16\_16\_OutputOpen,'ID'"

New Page Print Scripts

"WDPagePrintGrayWithDialog"  
 "WDPagePrintGray"  
 "WDPagePrintInvertWithDialog"  
 "WDPagePrintInvert"  
 "WDPagePrintGrayInvertWithDialog"  
 "WDPagePrintGrayInvert"

-New Custom Node AR Tool Kit ID Streamer (currently built in for non-commercial use and testing purposes only!)  
 -New Custom Node Face API Streamer (currently built in for non-commercial use and testing purposes only!)

Rev 191

Feature

-New Pandoras Box TCP auto re-connect built in  
 -New WD Remoting TCP Multi Client Mode added  
 -New Camera Point Tracker Color Tracking added

New Script:

"WDVideoGotoTime,'ID','Second'"

-New output node Video Player Time

New Page Print Scripts

"WDPagePrintWithDialog"

"WDPagePrint"

Change

-Camera Tracker(Beta)& node is now invisible, can be revealed using the shortcut Alt+C

Bugfix

-XY Panel paste fixed

-Multi-Touch paste fixed

-Memoryleak in TCP connections fixed

-WD Remote Touch Multi Client Server Message Processing improved

-Toggle Button State display on project load

-Label copy variablenames fixed

-Pagebrowser Thumbnail Refresh fixed

Rev 190

Feature

New Script "WDTextboxRefresh,'ID'" to update a textbox text for input nodes

New script "VGetTextboxText,VarName,TextboxID"

Changes:

New VNC dll - adds more stability to WD in case of network issues

Rev 189

Feature

-New Collision Panel

-Camera Point Tracker GUI optimized

-Camera Point Tracker Point ID Offset added

-Camera Point Tracker Range Conversion for Touchpoints added

This feature can be used if the camera point tracker should affect only a specific screen region, or if multiple Widgets are used with multiple camera point trackers together.

-Camera Point Tracker Performance optimized

-Camera Point Tracker now supports upto 100 touch inputs

-Camera Point Tracker RGB Image option for camera setup added

-Kinect Tracker Performance optimized

-Multi-Touch Panel properties dialog store & apply defaults button added

-Multi-Touch Panel properties dialog clear inputs button added

New Script: "WDMultiTouchClearInputs,'ID'"

New Commandline Startup Options

Allow to start Widget Designer in any of 4 screen quadrants

"Q1

"Q2

"Q3

"Q4

New Image Scripts:

"WDImageScreenshot,'ID'"

"WDImageScreenshotRegion,'ID','X','Y','Width','Height'"

New Script to activate other Application Windows in order to send Keystrokes to it via

"KeyboardKeyPress,'Keycode'" Script

"WindowFocus,'WindowTitleText'"

Bugfix

-Kinect Angle Distance between Point1 & 2 fixed

-TCP "No delay" option fixed

Rev 188

Feature

-Custom Script Button toggle state is saved and loaded

-Labels can be linked with variables, and update their content on variable changes

-Multi-Touch Panel adjustable RelaxTime(milliseconds) and max RelaxDelta(pixels) added

-Multi-Touch Bounce Border Mode added

-Multi-Touch Panel Multi-Site Mode added allows to control multiple Servers simultaneously (useful when virtual sites can not be used)

-Device Output Node supports Multi-Site mode to allow to control multiple Servers/Players simultaneously

New Script: "WDImageFile,'ID','File'"

Bugfix

-Page rename upper/lower case check added

-Invalid pages are ignored on file load

Rev 187

Feature

-Label Flash added

"WDLLabelStartFlash,'ID'", \_

"WDLLabelStopFlash,'ID'", \_

"WDLLabelFlashInterval,'ID','Value'"

-Page Thumbnail Icon added

-New Page Browser

Script: "OpenPageBrowser"

New Script added to enter Page without executing its script

Script: "WDPageGotoSilent,'Pagename'"

New Scripts for Customscripts and Faders added:

"WDCustomScriptFix,'ID'", \_

"WDCustomScriptUnfix,'ID'"

"WDFaderFix,'ID'", \_

"WDFaderUnfix,'ID'",

New Scripts for Kinect:

"KinectSetLedOff"

"KinectSetLedRed"

"KinectSetLedGreen"

"KinectSetLedGreenBlink"

"KinectSetLedOrange"

"KinectSetLedOrangeRedBlink"

Connection Manager Scroll Panel added

Connection Manager Tuio Transmitter added

AirScan TUIO Output added

New Script "StopSound"

Bugfix



- Delete Pages fixed
- Page thumbnail on save optimized
- Page relation on item ID change fixed
- Playsound fixed
- Change Video Files of VideoPlayer fixed

Rev 185/186

New PBautomation SDK dll implemented Connections via TCP/UDP added.

This version requires Pandoras Box rev 5547 or higher to work with

Feature

- Art-Net Snapshot Crossfadetime added
- Art-Net Snapshot Option to output to DMX Link Out interface
- Art-Net output node updates artnet only on change of input value

New Scripts:

"WDArtNetSnapshotCut,'ID'" - This applies the stored values directly without fading

"WDArtNetSnapshotSet8Bit,'ID','Ch','Val'" - This script allows to change the stored value of a specific 8bit channel value

"WDArtNetSnapshotSet16Bit,'ID','Ch','Val'" - This script allows to change the stored values with 16bit channel value input option

"WDAirScanPointCount,PointCount"

"WDDisconnectMaster"

"WDConnectMaster"

"WDDisconnectBackup"

"WDConnectBackup"

"KeyboardVolumeUp"

"KeyboardVolumeDown"

"KeyboardToggleVolume"

"WDMotionMaskClear,'ID'"

"WDMotionMaskUseAirScan,'ID'"

"WDMotionMaskDoNotUseAirScan,'ID'"

"WDMotionMaskUseCameraPointTracking,'ID'"

"WDMotionMaskDoNotUseCameraPointTracking,'ID'"

"WDMotionMaskUseIphone,'ID'"

"WDMotionMaskDoNotUseIphone,'ID'"

"WDMotionMaskUseKinect,'ID'"

"WDMotionMaskDoNotUseKinect,'ID'"

-MotionMask support AirScan/Camera Point Tracker/Kinect & iPhone multi-touch input for mask painting

-New Variable output node

-New PBAutomation.dll implemented - support for UDP and TCP Connection to Pandoras Box added in Network Configuration

Bugfix

-"WDTtextboxAppend,'ID','Value'" supports comma in Value field

-CITP thumbnail transfer enhanced support for longer file names and large amount of files

-CITP Port change is updated in the network configuration dialog

-Load/Save of CameraTracker (Beta) should now load and save the correct camera device on file load and save

-AirScan Mouse Offset fixed

-Art-NetSnapshot/Art-Net Sender internal array copy fixed

-Com Connection Stop/Start multiple items fixed

Rev 184

Feature

-Kinect Input Node support Bounding Box per detected Point 1-8 X/Y Pos & Width/Height

Bugfix

-Output Script Node Double to String Comparison Fixed

-Fader/Wheel&Encoder Mouse Leave fixed

-Fixed Restarting and "TCPStart,'ID'" Script for Multi-Client and Single-Client TCP Server connections  
 -Fixed Re-starting and "UDPStart,'ID'" Script for Broadcast and Multi-Cast UDP connections

Rev 182/183

Features

New Scripts:

"WDScreenshot,'FileName'"  
 "WDScreenshotWithTime,'FileName'"  
 "WDScreenshotDialog"  
 "WDScreenshotRegion,'X','Y','Width','Height','FileName'"  
 "WDScreenshotRegionWithTime,'X','Y','Width','Height','FileName'"  
 "WDScreenshotRegionDialog,'X','Y','Width','Height'"  
 "WDCloseSilent"

The following scripts allow to use a textbox to generate dynamic scripts to be executed at any given time

"WDTextboxAppend,'ID','Value'"  
 "WDTextboxNewline,'ID'"  
 "WDTextboxExecuteAsScript,'ID'"  
 "WDArtNetRecorderGotoFrame,'ID','Frame'"

Bugfix

-decimal point in number input for scripts fixed  
 -Replay Art-Net Recordings Fixed  
 -TCP&COM Script Nodes "Null" Filtering implemented, these scripts accept ASCII input only!

Rev 181

-Kinect Safe Region optimized to crop off all objects outside the Region

Bugfix

-Projects with Kinect load correctly under Win7 fixed

Rev 179

-Kinect Safe Region optimized, new check box to enable new points only when inside the saferegion

Bugfix

-On close all remaining script threads are terminated  
 -On close and load file access to Cancel Dialog fixed  
 -General node processing performance optimization for WD PRO

Rev 178

Bugfix

- ScriptTimer BG Fixed on paste  
 - Wheel orientation Handle File Change/Load  
 - FlipSwitch/Scroller ID change fixed

Rev 177

Feature

-New ScriptTimer Control

New Scripts:

"WDScriptTimerStart,'ID'"  
 "WDScriptTimerStop,'ID'"  
 "WDScriptTimerInterval,'ID','Value'"  
 "WDScriptTimerRunOnce,'ID'"  
 "WDScriptTimerRunContinuous,'ID'"

Bugfix

-Wheel/Encoder Handle Image fixed

Rev 175

Feature

-Kinect Active Region Added  
 -New "KinectStart" Script

## Bugfix

-Paste Angular Display does not corrupt file on save

## Rev 174

## Feature

-New Scroller Control

-New Flipswitch Control

-AirScan Dynamic Motion Damping (Improves the stability of the Touch point in motion and stabilizes the points when not moving)

-AirScan MaxDelta to determine maximum Speed for Multi touch Point Tracking

-AirScan MultiPoint Input Node outputs detected active point count

-Camera Point Tracker now supports up to 99 Objects/Points

-Camera Point Tracking Input Node added, incl. detected active point count

-Kinect Input Node outputs active point count

## Bugfix

-Loading Z-Order Fader,Encoder,Wheels Fixed

-ID Change on all Controls - Page update fixed

## Rev 173

## Feature

-Multitouch Panel now supports 2 Devices per Touchitem (for example a shadow is on a separate layer)

-Kinect Point Depth precision optimized

## Bugfix

-Load Last Config fixed

-Load MidiOutput Device fixed

-Fader Output Node enhanced

-Label import drag mode disabled

## Rev 172

## Bugfix

-Variables for WDWait fixed

-Variables for WDFaderScripts fixed

-Show Fullscreen Mask in Kinect Dialog when Points=0 - currently built-in for evaluation purposes

-Loading Pages on project load fixed

-Node property dialog fixed: Multitouchpanelpoint

-FadeToValue Script fixed

-Encoder fix

## Rev171

## Bugfix

-VNC fix

-CueList fix

## Rev170/169/168

## Feature

-Skinning can be turned on and off in Gui properties

-New Script:

```
"WDTextInputClear,'ID'"
```

```
"WDTextboxClear,'TXTBoxID'"
```

## BugFix

-Webbrowser works on Win7

-Text Input Load fixed

## Rev167

## Bugfix

-Multi-Touch panel re-load error fixed

## Rev 166

- Scripts resorted
- Bugfix
- MuteNode On Page Change fixed
  - Scrollbars fixed

## Rev 165

## Feature

- ImageLoader can now also copy video and audio files - image resizing parameters do not apply
- Multi-Touch Panel iphone WD Remote v1.1 support implemented
- Variable Double Calculation optimized
- BCD2000 Dialog fixed
- New ODSL30 Input Node

## Installer FIX

Correct Kinect Driver DLL is in installer

## Bugfix

- Load project non-existing page loading fixed
- UPD ASCII stream output fixed
- UDP/TCP ASCII stream output updates only on value change
- MultiTouch Panel Min Max Rotate fixed works between(-360 and +360°)

## Rev 164

## Feature

- New AirScan Multi-Point input node
- New Multi-Touch Panel Point input node

## New Script:

"WDScreenshotDialog"

## Bugfix

- Right Click Menu opening performance optimized
- Import Old Revisions Re-Save Backupfile generation error fixed
- Page loading after import old project fixed
- MultiTouch Input and node fixed

## Rev 163

## Bugfix

- Fix Feature repaired
- Page changes optimized

## Rev 160

## Feature

- New Multitouch Item input node
- Page initialization optimized on project load
- AirScan Point offset for Multi-Point mode, this allows to run WD on a secondary screen
- New Label drag mode

## New Scripts:

"WDMediaPanelSetNextFolder,'id'"

"WDMediaPanelSetPreviousFolder,'id'"

"WDScreenshot,'FileName'"

"SeqSetCuePlayMode,'SeqID','CueID','Play/Pause/Stop/Jump/Wait'"

"SeqSetNextCuePlayMode,'SeqID','Play/Pause/Stop/Jump/Wait'"

"SeqSetIgnoreNextCue,'SeqID'"

"SeqSetDoNotIgnoreNextCue,'SeqID'"

## Bugfix

- TCP/UDP/Com edit fixed
- HTTP Remoting Win7 fixed WD must run as Administrator in order to use this feature!
- TCP Remoting fixed

## Rev 159

## Kinect Driver Update!

-CL Nui DLL change to CL-NUI-Platform-1.0.0.1210 this driver MUST be used in order to work with the Kinect device.

It provides more stability and faster image processing

## Feature

-Faster Page switching and control redrawing

-Page Enter Leave Scripts

-AutoSort Pages on creation and edit

-FaceTracker multiple tracking options

## New Scripts:

Show/Hide any Control outside of its page context

This way you can unhide a control that originates from another page

"WDControlShow,'ControlName'"

"WDControlHide,'ControlName'"

## Bugfix

-Label Input node fixed

-Mediapanel script crash fixed

-MotionMask delete fixed

-UPD/TCP/COM Connection rename ID fixed

## Rev 158

-AirScan Safezone optimized

## New Scripts:

"WDAirScanMultiPointModeEnabled"

"WDAirScanMultiPointModeDisabled"

"WDNodeSetParamFromNodeInputValue,'NodeID','ParamID','SourceNodeID','SourceNodeInParamID'"

"WDNodeSetParamFromNodeOutputValue,'NodeID','ParamID','SourceNodeID','SourceNodeOutParamID'"

"WDKeyboardShortCutsEnable"

"WDKeyboardShortCutsDisable"

"ResourceSetTextUnicode,FolderID,FileID,Text"

"ResourceGetTextFromLabelUnicode,LabelID,FolderID,FileID"

"ResourceGetTextFromTextboxUnicode,LabelID,FolderID,FileID"

-Custom Script Buttons can now be coloured by selecting a tint colour, this applies only to the default button images

## Bugfix

-Keyboard Shortcuts arrow left right up down

-Contains Text node state output

-Dropdown Node list reset

## Rev 157&amp;156

## Important Change Notice:

Video Input Displays manage their own video inputs the video input tool is no longer needed and available.

Each Video Input can be connected to a unique Video Input device only.

For import of older projects video inputs need to be re-assigned in the video input property dialog.

## Features

-New Custom Node for the CDS Automation for Beatles Love Mirage

-New Vertical and Horizontal Wheel control

-New Wheel input node

-New Encoder control

-New Encoder input node

## -New Scripts:

"WDWheelGoUp,'ID','Value'"

"WDWheelGoDown,'ID','Value'"

"WDWheelValue,'ID','Value'"

"WDWheelFactor,'ID','Value'"

"WDEncoderGoUp,'ID','Value'"

"WDEncoderGoDown,'ID','Value'"

"WDEncoderValue,'ID','Value'"

"WDEncoderFactor,'ID','Value'"

-Pages can created with password protection

-New Edit Page function to change page name and password settings

-AirScan safe zone added for multipoint mode - this makes the detection of point on the border of the active region more robust.

-MSC Output Scripts

"MSCSend,'DeviceID','Type','Comand'"

"MSCSend,'DeviceID','Type','Comand','Cue'"

"MSCSend,'DeviceID','Type','Comand','Cue','CueList'"

"MSCSend,'DeviceID','Type','Comand','Cue','CueList','CuePath'"

DeviceID: All or [h0] to [h6F]

Type: All, Lighting, Video, Projection

Comand: Go, Stop, Resume, Reset, Go\_Off

Cue: x.yyy

Note:

It is possible that the Phidgets RFID do work only under Win7.

App hang has occured on XP when a RFID Tool and RFID Script Node Property Window is open at the same time

Brush

-All script textboxes now paste selected scripts to the current cursor position in the script textbox

-iPhone WD Remote Mouse modes converted to WD 3.0

-WD Viewer never asks to save file on app close

-In WD PRO double click on node opens its property dialog

-In WD PRO when in move or create mode double click on item opens its property dialog

Bugfix

-iPhone RemoteInput doe not interfere with connections on load and causes projects with multiple tcp connections to be unloadable

-iPhone connection and mouse mode load save fixed

Rev 155

Feature

-Facetracking input node: added width and height of bounding box

Bugfix

-MultitouchPanel device number reload fixed

-DampingTimed node can be be reset

-Grid Size Load Save added

Rev 154

Bugfix

Save overwrite fixed

Rev 153

Feature

New Script "DeviceSetIp,'SiteID','IPAddress'"

Bugfix

-msvcp71.dll and msucr71.dll added for pbcamtrack.dll compatibility to Win7 Home 32bit

-Importer Rev 151 & 152 fixed

Rev 152

Feature

-On WD close Message if tools or items have been changed File Changed Message appears.

New Scripts:

"WDCustomScriptSilentClickToggleAll"

"WDCustomScriptSilentReleaseToggleAll"

"DeviceSetIp,'SiteID','IPAddress'" with latest PB 4.7 version (newer than 25.01.2011)

Bugfix

- Variable Input Node now inits with 0
- On New and Load Phidgets are disabled not re initialized
- On New and XP systems all items are now removed
- Save & overwrite existing file after re-open of WD now works on MS XP

Bugfix

- New Skinning dll should fix Win7 32bit open file dialog crash

Rev 151

- Multi-Touch Panel Create and Load error fixed

Rev 150

- Load Save for Win XP fixed due to Kinect incompatibility
- Phidget Adv Servo load error fixed on connected servos

Rev 149

- PB Text Unicode output finalized

Rev 144

- Mechanism built-in that the Kinect Device runs only on Win7

Rev 143

\*Important Notice Regarding Kinect Device usage:

Kinect driver from codelaboratories is still an early version and seems to run stable on WIN7 only. When the Kinect Device is connected to a Win7 system there might be a driver conflict when using Logitech USB cameras at the same time.

Rev 141

\*Important Notice regarding Multi-Touch Input on Win7:

The Tablet Service must be active in order for Win7 to provide the multi touch data.

-New PBTextUnicode Output Node

This node allows to send textstrings in any language format to Pandoras Box text assets

Feature

New Scripts

"WDMultiTouchStoreDefaults,'ID'"

"WDMultiTouchApplyDefaults,'ID'"

"WDMultiTouchEnableMouse,'ID'"

"WDMultiTouchDisableMouse,'ID'"

"WDMultiTouchEnableGestures,'ID'" 'For Synaptics Touch Pads and Wacom Bamboo Devices

"WDMultiTouchDisableGestures,'ID'" 'For Synaptics Touch Pads and Wacom Bamboo Devices

"WDMultiTouchEnableTouch,'ID'"

"WDMultiTouchDisableTouch,'ID'"

"WDMultiTouchEnableAirScan,'ID'"

"WDMultiTouchDisableAirScan,'ID'"

"WDMultiTouchEnableKinect,'ID'"

"WDMultiTouchDisableKinect,'ID'"

"WDMultiTouchEnableCamera,'ID'"

"WDMultiTouchDisableCamera,'ID'"

"WDMultiTouchEnableIPhone,'ID'"

"WDMultiTouchDisableIPhone,'ID'"

Rev 140

Feature

- AirScan new Multi Touch Mode finished

- Camera Tracking Multi Touch implemented
- Kinect Performance improvement, Do not use Kinect Dialog in Show mode (The rendering of the Depth Camera requires too much system performance)
- Multi-Touch Panel Multi-User Multi-Touch enabled for Kinect, AirScan, Camera Tracking and generic Multi-Touch Input Devices (Win7)
- Multi-Touch Panel Performance mode (Draw Outlines) to enable support of 48 simultaneous Touchitems
- Multi-Touch Panel Bounding Box and Region Check implemented
- Simultaneous redraw of multiple Fader movements optimized

#### New Scripts

"WDMacroBoxOkCancel,Title,Content,MacroName1,MacroName2"

"WDMacroBoxYesNo,Title,Content,MacroName1,MacroName2"

#### Bugfix

- Multi-Touch Panel Touch Item enter/leave events fixed

#### Rev 139

##### Feature

- New Cuelist control for Scripts with JumpCues & Auto-Follow WaitTimes

##### -New Cuelist Scripts:

"WDCueListGO,'ID'"

"WDCueListPause,'ID'"

"WDCueListGo-,'ID'"

"WDCueListRecall,'ID'"

"WDCueListGotoCue,'ID','Cue'"

"WDCueListPrevCue,'ID'"

"WDCueListNextCue,'ID'"

"WDCueListFirstCue,'ID'"

"WDCueListLastCue,'ID'"

"WDCueListResetJumps,'ID'"

"WDCueListCancelWaits,'ID'"

- GPS Comport Input node, compatible with NMEA 0183 - with GPGGA dataformat, tested with Navilock USB GPS Input device

#### Bugfix

- Video input displays load and save fixed
- Import of video input displays needs re apply of video input source to display item
- Art-Net Input on/off switching fixed, once Art-Net input is started the input will be muted by the checkbox in the connection manager
- Faderoutputnode all importers fixed
- Audio Inputnode more robust on low memory

#### Rev 138

##### Feature

- Connect Node over Pages, allows to connect nodes on different pages, to do this when dragging the connect node line press page up or down to navigate to the desired page
- Loadfile automatically imports old projects
- New Variable input node
- New Math filter node Sum, that allows to sum up all input values attached. This is useful when connecting many delta nodes to determine easily when one of them has changed its value.  
Like is anything changed or moving.

#### Bugfix

- Artnet recorder play via script fixed
- First save action after openfile fixed
- Artnet outputnode load



## Rev 137

## Feature

- Custom Script Mute Option with Time in milliseconds:  
set a specific time in milliseconds for a custom script click script to be muted (not executed)  
this protects a customscript from accidental double clicks

## Rev 136

## Feature

- Art-Net Output Node support output to multiple 8 or 16 bit channels  
simply type in all DMX startaddresses and use a white space inbetween them i.e.:1 2 123

## Rev 135

## Feature

- Import Rev133 added

## Rev 134

## Change

- TextInput Scripts Name Changed
- Scripts Resorted
- Loading optimized all Midi and Keyboard inputs can now be enabled/disabled
- Video inputs are only loaded when inuse
- Widget Project Files are stored as bundles from now on with all resource files(images videos etc,...)

## Features

## New Scripts:

"WDFaderAbortFade, 'ID'"

"WDWaitCancelItem, ItemName"

## New Fader Script:

"WDFadeToValue, 'ID', 'Seconds', 'Value'"

## New Scripts to create variables and use them

"VString, Name, Value"

"VInt, Name, Value"

"VDouble, Name, Value"

"VDelete, Name"

"VDeleteAll"

"VValue, VarName, Value"

"VGetNodeVal, VarName, NodeID, ParamID"

"VGetFaderVal, VarName, FaderID"

"VGetLabelText, VarName, LabelID"

"VMultiply, VarName, Var1, Var2"

"VDivide, VarName, Var1, Var2"

"VAdd, VarName, Var1, Var2"

"VSubtract, VarName, Var1, Var2"

"VPow, VarName, Var1, Var2"

"V.Sqrt, VarName, Var1"

## New Tool: Variablelist

All scripts support variablenames as input values

## Bugfix

- MotionMask Script Decimal Value input fixed

## Rev 133

## Feature

- Connection Manager Art-Net output has a new option to support Artistic Licence devices that require a reuse udp port option
- New Phidget RFID Receiver implemented (P/N 2002)

-New Phidget RFID Script Node implemented  
 -New Phidget IR Scripts:  
 "PHRFIDEnable"  
 "PHRFIDDisable"

Rev 132  
 Bugfix  
 Art-Net Recorder on delete item stop looped playback fixed

Rev 131  
 Bugfix  
 Art-Net Recorder In/Out Frame fixed

Rev 130  
 Feature  
 -Mouse Output Node only moves the mouse when input value has changed  
 -New Script to display a message box that blocks the UI  
 "WDMessageBox, Title, Content"  
 -New Fader Script to stop and abort all currently running fades  
 "WDFaderAbortAllFades"

Rev 129  
 Feature  
 -New Phidget IR transmitter receiver implemented (P/N 1055)  
 This Tool allows sending and receiving of IR Codes  
 Received IR Codes can be learned and stored with an Alias name for use in Scripts to retransmit the code.  
 This way you any remote control ir code can be recorded and send via Scripts  
 -New Phidget IR Scripts:  
 "PHIREnable"  
 "PHIRDisable"  
 "PHIRSend, 'IRAlias'"  
 -New Phidget IR Script Node - allows to link scripts to incoming IR Codes  
 -New PB Automation.dll  
 -New PB Text Scripts (available with Pandoras Box Rev 4982 and higher)  
 "ResourceSetTextSize, FolderID, FileID, Width, Height"  
 "ResourceSetTextFullSize, FolderID, FileID"  
 "ResourceSetTextCentered, FolderID, FileID"  
 "ResourceSetTextStyle, FolderID, FileID, Font, Size, Style, Alignment, Red, Green, Blue"  
 Style: Regular, Bold, Italic, BoldItalic, Underline  
 Alignment: Left, Center, Right  
 Bugfix:  
 -Show Help is fixed  
 -On Open Phidgets Dialogs WD checks if the Phidgets Manager is installed and running, otherwise this leads to crashes and malfunctioning of WD if the Phidget driver is not available

Rev 126  
 Feature  
 -New Kinect Driver Support preliminary driver from CL NUI  
 Please install the Platform driver first in order to use Kinect within Widget.  
 The Kinect must be plugged in for the Driver to work other wise it will terminate the WD application when no device is attached.  
 The driver is currently a preliminary one, as soon as there are updates we will look into integrating them.  
 The Kinect Implementation currently supports node only, (Multi Touch input to the Multi-Touch Panel is not implemented in this Revision yet)  
 -Kinect Input Node for capturing up to 8 filtered and tracked points/regions of interest  
 -Kinect Scripts:

"KinectEnable"  
 "KinectDisable"  
 "KinectSetTilt, '-8000>+8000'"  
 "KinectSetDepthThreshold, '0-2047'"  
 "KinectSetNearThreshold, '0-2047'"  
 "KinectSetPoints, '1-8'"  
 "KinectSetBlur, '0-15'"  
 "KinectSetInflate, '0-15'"  
 "KinectSetShrink, '0-15'"  
 "KinectSetMinWidth, 'value'"  
 "KinectSetMinHeight, 'value'"  
 "KinectSetMaxWidth, 'value'"  
 "KinectSetMaxHeight, 'value'"  
 "KinectSetMaxDelta, 'value'"  
 -New Changelog Viewer In R-Click Menu  
 -New Phidget ([www.phidgets.com](http://www.phidgets.com)) Advanced Servo Controller (P/N 1061) implemented.  
 The Phidget advanced Servo provides an interface to control 8RC analog servo motors.  
 Use the following Scripts to change acceleration, maximum velocity and position.  
 "PHAdvServoEnable, 'ID'"  
 "PHAdvServoDisable, 'ID'"  
 "PHAdvServoSetPosition, 'ID', 'Pos'"  
 "PHAdvServoSetVelocity, 'ID', 'Pos'"  
 "PHAdvServoSetAcceleration, 'ID', 'Pos'"  
 "PHAdvServoSpeedRampingOn, 'ID'"  
 "PHAdvServoSpeedRampingOff, 'ID'"

#### Rev 125

##### Feature

- Confirmation dialog on Delete All Macros added
- New TrackScan Serial Link Node, for use with TrackScans Rev2 only (Serial Link Ports must be set to 9600 Parity Off and RS232 TX/RX must be swapped)
- TrackScan Input node selection Rev1(57600/8n1) / Rev2 (9600/8n1)
- New Scripts for Artnet Snapshot: "WDArtNetSnapshotActivate, 'ID'"
- New Button Art-Net Recorder, allowing to record timed Art-Net sequences, available scripts:

"WDArtNetRecorderPlay, 'ID'"  
 "WDArtNetRecorderPause, 'ID'"  
 "WDArtNetRecorderRewind, 'ID'"  
 "WDArtNetRecorderLoop, 'ID'"  
 "WDArtNetRecorderPlayOnce, 'ID'"

IMPORTANT: Art-Net Recordings are stored in a specific file in the same directory as the widget project .wdp,

when moving a widget project to a different file location or different computer the filename must be renamed in the project file.

- Motion Detector Input node now support last changed cell x,y and value as well as the sum of all cells and the average of all cell values
- On File->New all open property windows are closed

##### Bugfix

- ArtnetSnapshot Mouse Enter Leave Script fixed
- VNC Viewer Import error fixed for older versions

#### Rev 123

##### Feature

- New Script support for Chamsys MagicQ Remote Playback Commands (based on MagicQ default UDP Port 6553)

"MagicQActivatePlayback, 'ID'"  
 "MagicQReleasePlayback, 'ID'"  
 "MagicQTestPlayback, 'ID'"

"MagicQUntestPlayback,'ID'"  
"MagicQGoOnPlayback,'ID'"  
"MagicQStopOnPlayback,'ID'"  
"MagicQFastBackOnPlayback,'ID'"  
"MagicQFastForwardOnPlayback,'ID'"  
"MagicQChangePage,'ID'"  
"MagicQPlaybackLevel,'ID','Level'"

#### Bugfix

-TCP/UDP/COM Input node does not keep blocking incoming messages in ASCII mode when no start bytes are defined  
-TCP/UDP/COM Tester re-open fixed  
-Script Output Node can now handle and compare both text and numeric input values

#### Rev 122

-Node Background Colour can be changed via Edit Node  
-New Script to refresh Multi-Touch Panel values  
"WDMultiTouchRefresh,'ID'"

#### Rev 121

-Rename Node changed to Edit Node  
-Edit Node allows to change node background colors  
-New Macro for refreshing the Multi Touch Panel values to PB:  
"WDMultiTouchRefresh,'ID'"

#### Rev 120

##### Feature

-TrackScan Serial Link Input node, requires Serial Link to be connected as TCP client connection in Connection Manager

##### Bugfix

-Akai APC Static Encoder Bugfix  
-TCP/UDP/COM Tester Dialog fix

#### Rev 117

##### Feature

-New Face Tracker Tool incl input node  
-New Motion Detector Tool incl input node  
-CITP "SInf" Compatibility with Server Information Message built-in (important for compatibility with Avolites Consoles)  
-Enhanced Midi Message Support for Icon Fader Boards allowing to process Status bytes of value 11 thru 14

##### Bugfix

-Video Inputs source switching refined  
-"Fix" works after file reload

#### Rev 116

##### Feature

-New TCP/UDP/Com Port Message Tester in Connection Right-Click Context Menu  
-New VNC Panel Component with better performance for multiple sessions

##### Bugfix

-Delete Artnet Snapshot button fixed  
-On create new Digital Display thrown error resolved

##### Changes:

-Due to win7 compatibility uninstall has to be done via Add Remove Software from the Windows Control Panel

##### Known Issues:

Disable Fix of user controls, needs a page refresh  
Artnet snapshot with zero values does not update fast

## Rev 114

## Feature

- New Scripts:

```
"WDTextPanelReset,'PanelID', _
"WDTextPanelNext,'PanelID"', _
"WDTextPanelLast,'PanelID"', _
"WDTextPanelUpdate,'PanelID'"
```

-Wacom Bamboo Touch Rotate and Pinch Zoom support for MultiTouch Panel

## Rev 113

## Feature

-Rotation built-in for Multi-Touch Panel

## Rev 112

## Feature

-Fix Option for controls to be displayed on all pages

-New Drawing Canvas with scripts:

```
"WDDrawingCanvasClear,'ID', _
"WDDrawingCanvasSetPenSize,'ID','Size', _
"WDDrawingCanvasSetPenCol,'ID','R','G','B"', _
"WDDrawingCanvasSetBGCol,'ID','R','G','B"', ""', _
```

-New Motion Mask Display - allows to use a DirectShow Video input to create a soft motiondetected Mask

MotionMask Scripts:

```
"WDMotionMaskSetScale,'ID','Value"', _
"WDMotionMaskSetInValue,'ID','Value"', _
"WDMotionMaskSetOutValue,'ID','Value"', _
"WDMotionMaskSetThreshold,'ID','Value"', _
"WDMotionMaskSetPaintOnly,'ID','Bool'"
```

-Camera Tracking Updated, option to show/hide Events

-Compiled for and on Win7 64bit as x86 32bit application, should work normally under Win XP (first test are positive)

BugFix

-Value Node not empty on start, fixes crash

-Art-Net 16bit value Output fixed

## Rev 110

-Multitouch Panel Mouseover enter leave script fix

-Multitouch Airscan Size fix

## Rev 109

-Multitouch Panel optimizations

## Rev 108

## Feature

-New MultiTouch Panel, allows direct control of up to 48 layers as interactive touch surfaces

-New Scripts for MultiTouch Panel

```
"WDMultiTouchSetZoom,Id,Zoomfactor"
"WDMultiTouchSetPan,Id,x,y"
"WDMultiTouchSetActive,Id,Itemid"
"WDMultiTouchSetInActive,Id,Itemid"
"WDMultiTouchSetDevice,Id,Itemid,Siteld,Deviceld"
"WDMultiTouchSetPos,Id,Itemid,Xpos,Ypos"
"WDMultiTouchSetRot,Id,Itemid,Rot"
"WDMultiTouchSetScale,Id,Itemid,Scale"
"WDMultiTouchEnableZoom,Id,Itemid"
"WDMultiTouchDisableZoom,Id,Itemid"
```

"WDMultiTouchEnableDrag,Id,Itemid"  
 "WDMultiTouchDisableDrag,Id,Itemid"  
 "WDMultiTouchEnablePan,Id,Itemid"  
 "WDMultiTouchDisablePan,Id,Itemid"  
 "WDMultiTouchEnableSize,Id,Itemid"  
 "WDMultiTouchDisableSize,Id,Itemid"  
 "WDMultiTouchEnableRotate,Id,Itemid"  
 "WDMultiTouchDisableRotate,Id,Itemid"  
 "WDMultiTouchLayerMode,Id,Itemid,LayerMode"  
 "WDMultiTouchDisplayMode,Id,DisplayMode"  
 "WDMultiTouchEnableZorder,Id"  
 "WDMultiTouchDisableZorder,Id"  
 -New Page Input node, shows current page  
 -New Page Output node, changes page on value change  
 -New Value Output, changes Value Input node  
 Bugfix  
 -Paste node with Empty parameters fixed  
 -Camera Tracker works after file load or new

#### Rev105-107

##### Feature

-New Input Script support for Logitech Presenter  
 -New Script To set input nodes output to a specific value (applies to TCP/UDP/COM inputnodes)  
 "WDNodeSetOutput,'NodeID','ParamID','Value'"  
 -OSC Input node output OSC Msg for processing any message  
 -Blacklist filters also single words  
 -Page Upd down only available in Move/Edit mode

##### Bugfix

-XY Panel load fixed  
 -Load / new project fixed script crash  
 -Add /Paste node code cleanup  
 -Video Inputs set to none instead of default  
 -SMS Blacklist can be activated and deactivated  
 -Output node PB Text saving empty Message fixed  
 -Viewer Mode Context Menu fixed

#### Rev104

##### Feature

-OSC Input node (Requires a UDP Broadcast Input Connection) tested with Touch OSC on iPhone/iPad/iPod  
 -DMX Link In Support (Connection Manager)  
 -DMX Link Out Support (Connection Manager)  
 -New Scripts:  
 "DMXLinkOutSetVal8bit,'Channel','Value 0-255'"  
 "DMXLinkOutSetVal16bit,'Channel','Value 0-65535'"  
 "DMXLinkInEnable"  
 "DMXLinkInDisable"  
 "DMXLinkInReset"  
 "DMXLinkOutEnable"  
 "DMXLinkOutDisable"  
 "DMXLinkOutReset"  
 "WDNBSBroadcastEnable"  
 "WDNBSBroadcastDisable"  
 "WDNBSReceiveEnable"  
 "WDNBSReceiveDisable"

## Rev103

## Feature

- Kinesys K2 Input Node for X,Y,Z, Pitch, Tilt & Roll data
- UDP Multicast Client option added in Connectionmanager

## Rev100

## Feature

- Editing Name & ID of TCP/UDP/COM connections implemented (Right-Click on Connection in Connection Manager)
- Rename Nodes via Right Click Menu
- Loadfile progressbar
- Filename is displayed in the top of the interface when in Move/Edit Mode

## Rev99

## Feature

- New NBS (Network Broadcast Service)  
NBS allows to transmit and update Labels, Faders & CustomScripts across multiple WD Designers instances on the network  
use the IP Config to enable/disable the service  
use the label properties to configure send and receive mode
  - New Scripts:  
"WDDownloadThumbnails"  
"WDWaitCancelAll"
  - Fader positions are stored in project
- Bugfix
- Performance fix for Script threads
  - Fader works with node without parameter assignment
  - ToggleFullscreen Script fixed

## Rev97

## Feature

- New Filter Node to generate Leading Zeros for Text, this is especially useful for scoreboard counts
  - New Custom Node com Loopback Switch with timeout
  - COMQuery and TCP Query nodes included timeout value
  - Email send script from label
  - Email send script from textbox
  - Text Combine Filter Supports single entry for Line Feed [LF]
  - New hidden Service Control (For experienced Users only!) Scripts:  
"SystemServiceStop,ServiceName"  
"SystemServiceStart,ServiceName"
  - New Mouse Control Script  
"MouseMove,xPos,yPos"  
"MouseLeftClick"  
"MouseRightClick"
  - New "EmailSendDisable" and "EmailSendEnable" Script
  - New "SMSSendDisable" and "SMSSendEnable" Script
- Bugfix
- Loading Stopped Com Ports Fixed
  - SMS Licencing fixed
  - Midi Device receive Messages Fixed
  - TrayOnly Mode Fixed
  - Delete Entire Page including XY Panel Fixed
  - Paste Label ID fixed

## Rev 96

## Feature

- CustomScript Mouse Capture now supports Mouse enter and Leave Events

-New Scripts for more detailed XY Control  
 "WDXYPanelResetDefault,'PanelID'"  
 "WDXYPanelSetXDefault,'PanelID','Value'"  
 "WDXYPanelSetYDefault,'PanelID','Value'"  
 "WDXYPanelSetXPosRelative,'PanelID','Value'"  
 "WDXYPanelResetXPosRelative,'PanelID'"  
 "WDXYPanelSetYPosRelative,'PanelID','Value'"  
 "WDXYPanelResetYPosRelative,'PanelID'"  
 "WDXYPanelSetDistanceRelative,'PanelID','Value'"  
 "WDXYPanelResetDistanceRelative,'PanelID'"  
 "WDXYPanelSetAngleRelative,'PanelID','Value'"  
 "WDXYPanelResetAngleRelative,'PanelID'"  
 Bugfix  
 -Import Rev93 fixed  
 -Video Snapshot load project Delay Time fixed

#### Rev94

##### Feature

-New Midi Note Catch node, this node can be reset by setting Parameter 1 to 0 via script.  
 The node catches and outputs the first incoming Midi Note Message.  
 This is in particular useful for game scenarios where WD needs to identify the first incoming Midi Note event.

-New Art-Net Snapshot Button, records a full Art-Net DMX universe state, with the ability to record from Universe A and output to Universe B

##### -New Script Commands

"DeviceSetParamInSelection,ParamName,AbsoluteValue"  
 "DeviceSetParamRelativeInSelection,ParamName,RelativeValue"  
 -New TCP Query String Node (changes apply to COM Query String node as well):  
 filter first response String that is CR LF or ETX terminated  
 if interval is set to zero, the request is only send on apply or via WDDeviceSetParam scripts  
 Bugfix  
 - X&Y Panel shows Mouse point on mouse click and drag and Mouse control works again  
 - CustomScript Timeout is not executed in Move mode  
 - Events: Weekly Events error on end of month fixed  
 - Midi Note input bugfix

#### Rev93

##### Bugfix

-Delta Filter Node calculates double precision delta  
 -Open Airscan Toolbox does not Disconnect the TCP Connection anymore  
 -Airscan & XY panel optimized for better Point Enter and Leave handling  
 -Smpte Set Timecode Script Fixed

#### Rev92

##### Feature

- New Scripts:  
 WDPasswdDialog,'Password'  
 Opens Password Dialog, if the password is incorrect the script will not continue  
 This is useful to lock access to specific Pages or Commands  
 WDDeviceSetParam+=,'NodeID','ParamID','Value'  
 WDDeviceSetParam-='NodeID','ParamID','Value'  
 WDDeviceSetParam\*='NodeID','ParamID','Value'  
 WDDeviceSetParam/=,'NodeID','ParamID','Value'  
 Allows to alter the current value of a given Parameter ID  
 WDDeviceSetParamFromNodeValue,'NodeID','ParamID','SourceNodeID','SourceNodeParamID'



Allows to combine the current values of Nodes by ID

WDNodeSetParamFromNode+=, 'NodeID', 'ParamID', 'SourceNodeID', 'SourceNodeParamID'

WDNodeSetParamFromNode-=, 'NodeID', 'ParamID', 'SourceNodeID', 'SourceNodeParamID'

WDNodeSetParamFromNode\*=?, 'NodeID', 'ParamID', 'SourceNodeID', 'SourceNodeParamID'

WDNodeSetParamFromNode/=, 'NodeID', 'ParamID', 'SourceNodeID', 'SourceNodeParamID'

This way node values can be dynamically changed via scripts to any number, without causing infinite loops

Bugfix

- Custom Script Mouse Capture works no matter if WD is minimized or maximized

Rev91

Info

-Compiles for x86 (in preparation for Win7 compatibility)

Feature

-New Ping Input Node, get feedback if IP is online

-New COM Query String Node, get ASCII feedback messages from COM device

-Single Node Connection can be deleted:

select node connection by clicking on it in move/edit mode

press delete to delete the connection

-Node Structures are included in copy/paste

-Control IDs are changeable via property pages

-Control IDs are shown in Move/Edit Mode

-New Scripts:

WDNodeConnect, 'SourceNodeID', 'TargetNodeID'

WDNodeDisconnect, 'NodeID', 'SourceNodeID'

-Custom Script Buttons allow to capture mouse left click even when WD Gui is in the background, this is usefull when WD is used on the same machine as

Pandoras Box Players or Servers

-WD Scripts can be written in upper or lower case style or mixed

Bugfix

-CamTrack Node Points update fixed

-WD Wait Script Times are now system time accurate

-WD Wait Script does not block GUI any more, mulitple Wait times can be stacked and processed in parallel

-Fader FadeUp/Down Times are now system time accurate

-Artnet Send Channel Count fix

-Label BG Colour Fix

-Error on Akai Midi Input Script fixed

Rev89

Bugfix

-Active Comports close fine on close and file reload.

-VideoSnapshots deletion fixed(caused WD save error)

Rev87

Feature

- New Script nodes for TCP/UDP/COM for direct Script action on received packets

- BPM detection based on Midi beat Clock with Midi Input nodes

Bugfix

- GotoCue in Seq Output Node

- Startup Script WD Close Fixed

Rev86

BugFix

- TCP/UPD/COM INput Stream reads ASCII 8bit to support Umlaute as äöüß etc

- Email Send supports multi-line

- Email Input node Random Email fixed

---

#### Rev 85

##### BugFix

- If Node Outputstate fixed
- Round Node variable input fixed
- Textinput next/last fixed

#### Rev84

##### Minor fixes

#### Rev83

##### Feature

- Angular Display Range Input enhanced
- Art-Net Output Node HighSpeed Option - Default is off (enables 60hz refresh, not supported by GrandMA consoles)
- Colour Picker CMY option added
- Colour Picker Input node provides CMY values

##### BugFix

- TextReader Input node fixed
- for Spark Rev 16 compatibility - no feedback messages are sent upon TCP connections
- Iphone WD Remote input loading fixed
- Creating an RSS Input Node before going to the RSS Setting fixed
- Delete Colour Picker via menu fixed

#### Rev82

##### Feature

- when all items of a type are deleted the id is automatically reset to 1
- Event Viewer is now sizable
- Text Input is now sizable
- New Setting in Main Gui Properties to enable/disable start of WD on System Start
- New Message Box to confirm any delete action

##### Bugfix

- Delete Timecode Display fixed
- Delete VideovInput Display fixed

#### Rev80

##### Bugfix

- Skinning does not affect Webbrowser anymore

#### Rev77

##### Info

- Visual C++ 2005 Redistributable Package is required on install  
this is "normally" installed with the .net Framework 2.0/3.5

##### Feature

- New Master Node On Off setting via Scripts
- New Value Input node
- New GUI Option TrayOnly, in combination with Minimize allows to start a project in Taskbar Tray only
- New Output Node Video Player Volume, to control the volume of playing video or audio files

##### Bugfix

- Z-order on load of all new controls fixed
- AKAI APC button issue fixed

#### Rev76

##### Feature

- AKAI APC40 Midi control integration featuring
  - Master Seq Level
  - Multiple Seq Play/Pause control

Direct Seq control  
Jog Dial Time/Cue

- On new Page creation the new page is loaded
  - New Page Navigation Scripts:
    - "WDPageNext"
    - "WDPageLast"
    - "WDPageForward"
    - "WDPagePrevious"
    - "WDPageClearHistory"
  - Export SMS
  - Export Email
  - new Smpte Link Scripts
  - new Smpte Link Input Node
  - new Timecode Display for current Smpte Link Time
  - Smpte Link implemented into Connection Manager
  - new Colour Picker Scripts to change associated devices and BG Colour
  - new Colour Picker Input Node
  - new Colour Picker Control
  - new Video Snapshot Button, allows to send snapshot of Video Input display to an Asset to Pandoras Box
  - new Video Input Display
  - new Video Inputs (max. 16)
- Bugfix
- Mediapanel scripts refined

Rev75

Info

- new PB Automation dll (allows unlimited characters for PB Text Assets)

Feature

- new output node to bar graph display
- new output node to angular display
- new output node to digital display
- new bar graph display
- new angular numeric display
- new digital numeric display
- new analog clock control (sizable and with detailed settings)
- new digital clock control (with individual sizing and colour settings)
- custom color palette is stored and loaded with each project
- all color dialogs open with full layout and share custom color palette

Bugfix

- when grid is active node connections are now visible
- clock and mediapanel control can now be deleted via right click menu

Rev74

Info

- new Spacenavigator driver support 3.8.2

Feature

Bugfix

- Image Loader Delete on keypress fixed
- Contains Text Node Input fixed
- Text Combiner Dialog fixed
- Save DateToText Node fixed
- Save Label with multiple lines fixed
- Save Label output node with multiple lines fixed
- Save Textbox Output node fixed
- Save Compare Text node fixed

- Save Contains Text node fixed
- Save Text Combiner node fixed
- Save TCP/UDP/COM ASCII output node fixed
- Save PB Text output node fixed
- Excel input node Updateinterval fixed
- Fixed last/next cue and frame in CueControl
- Fixed Countdown dialog readout

#### Rev73

##### Feature

- Image Loader Button, allows to reload a PB Image asset based on its file location and Folder and FileID

##### BugFix

- MediaPanel scripts currently disabled from comboboxes due to unpredictable crash
- Timax Input Node LoadSave and Port dispose fixed
- Rss input duplicates fixed
- AutoPoll for new emails fixed

#### Rev72

##### Feature

- New Count Down Input Node
- New Output Nodes TCP/UDP/COM ASCII Stream, to constantly send any text/string message with start and stop bytes
- New DataType in TCP/UDP/COM input nodes to support signed integers type=3 HiLo Byteorder type=4 LoHi Byteorder
- New Text Compare Node, to check if two text are identical
- New Text Contains Node, to check if a text contains part of a text
- New Scripts to add text to text boxes:  
"WDTextboxAddTextFromLabel,'TXTBoxID','LabelID'"  
"WDTextboxAddTextFromTextbox,'TXTBoxID','TXTBoxSourceID'"
- Button to save bitmap of current frame in Camera Tracking dialog
- New Excel Reader Input Node, to readonly single cells from excel file
- TCP/UDP/COM Input Node option to choose if multi part messages are processed as well
- New Events Input Node
- New Blacklist to filter incoming SMS/Email/RSS
- RSS Load/Save built-in

##### Bugfix

- COM Output node output fixed
- RSS Tool refined
- Text Reader Input node fixed
- IF Filter Node Output State fixed

#### Rev71

##### Feature

- New RSS Input Node
- Fader Property Dialog show current Fader Value
- New Event Viewer Control

##### Bugfix

- Events optimized to never execute an event on a given time twice
- WD Wait accepts integer or decimal values

#### Rev70

##### Feature

- New Clock Control
- Current Filename is displayed in Main Gui Property Dialog
- New SMS Input Node
- New SMS Tool to receive textmessages with GSM modems

- New Email Input Node
- New Text Reader Input Node, to output single lines of text or cycle thru all lines of a textfile
- New "3D Connexion Space Navigator" 6 Axis Input Node,  
Please note, that currently only one unit is supported per WD project
- New Scripts to open common tools dialogs
- New Scripts to change MediaPanels Folder Index Device and Layout temporarily
- New Paste ShortCut CTRL+P, Pastes controls at the same location in the UI  
This is very useful when group of controls need to be copied to multiple pages.
- New Cue Control
- New Textbox Output Node
- New Textbox Input node
- New Textbox Control
- New Label Input Node
- New Script to copy text from textbox to PB Text Asset

#### BugFix

- TCP/UDP/COM Input nodes integer Reception fixed
- TCP/UDP/COM Input nodes output 0 if no value is received
- Import Label Fontsizes Fixed
- Load Button and Customscript fontsize check implemented
- Paste Positioning fixed in relation to current mouse position
- MediaPanel Past on new Page fixed

#### Bugfix

- Import Rev61 Fixed
- (internal) Skinning and VNC components rebuild
- VideoPlayer and Browser are properly deleted on Page delete

#### Rev 65

##### Feature

- New Output Parameter "Connection State" for Sensor Link Input Node
- New PB Help File included in Menu and F1 shortcut
- New Script ResourceGetTextFromLabel, allows to copy a Labeltext property to a PB Text Asset
- New Script "WDSave" and "WDSaveAs"
- New Tool Email Settings, for use with outgoing smtp email servers
- New Scripts for Email setup and Email sending with or without Attachment

##### Bugfix

- App crash of VNC Property Dialog resolved

#### Rev 61

##### Feature

- New PB Sequence Seek Output node
- New PB Text Output Node to update Pandoras Box Text Assets in Realtime
- New String Combiner Filter node, allows to combine up to 8 inputs as a Text string
- New WDPRO CameraTracking(for beta testing) Input Interface and Camera Input Node for up to 8 Tracking points

##### - Wii Input Node Enhanced:

added Support for up to 4 Wii controllers

added Support for Nunchuk

added Support for Balance Board

- WDFaderGoUp and WDFaderGoDown scripts renamed

- WDWait script supports decimal places like "0.23" for 230 milliseconds

- New PB Automation Script Support compatible with PB v4.5 Rev3688:

"ResourceReloadMedia,FolderID,FileID"

"ResourceReloadMesh,FolderID,FileID"

"PBLoadProject,Path,Name,SaveCurrent"

"PBLoadProject,Path,Name,DoNotSaveCurrent"

"ResourceCreateText,FolderID,FileID,Text"

"SeqSetTimecodeMode,SeqID,None"  
 "SeqSetTimecodeMode,SeqID,Send"  
 "SeqSetTimecodeMode,SeqID,Receive"  
 "SeqSetTimecodeOffset,SeqID,HH,MM,SS,FF"  
 "SeqSetTimecodeStopAction,SeqID,Stop"  
 "SeqSetTimecodeStopAction,SeqID,Pause"  
 "SeqSetTimecodeStopAction,SeqID,Continue"  
 "PBCloseProject,SaveCurrent"  
 "PBCloseProject,DoNotSaveCurrent"  
 "ClearSelection"  
 "DeviceAcceptDmxByld,SitID,DeviceID,On"  
 "DeviceAcceptDmxByld,SitID,DeviceID,Off"  
 "SiteAcceptDmxByld,SitID,On"  
 "SiteAcceptDmxByld,SitID,Off"  
 "DeviceSetDmxAddress,SitID,DeviceID,DMXStart,Universe,Subnet"  
 - Label Output Node can now be used to display any value type(i.e reading the ASCII string of TCP/UDP/COM input nodes)  
 - TCP/UDP/COM input nodes allow to intercept the entire input message as ASCII when no filtering and byte splitting is applied.  
 Bugfix  
 -Label Output Node now supports decimal places (doubles)  
 -Division Node Property page does not delete inputsource node entrys anymore  
 -Substract Node Property page does not delete inputsource node entrys anymore

#### Rev 59

##### Feature

- New Shortcut CTRL+SHIFT+M Maximise the interface on the Primary screen
- New Shortcut CTRL+SHIFT+T Show Main GUI Title Bar
- New Shortcut CTRL+SHIFT+F Hide All Main Gui Title Bars

##### Bugfix

- Label load fontsize parsing optimized
- Filter Range Node now converts static input values as well

#### Rev 57

##### Feature

- New AirTouch Input Node (currently supports one pair of AirBars per com connection)
- Half & Quarter Buttons Support custom Bitmaps from Filesystem or Thumbnail browser

#### Rev 56

##### Feature

- New Script Custom Script Force Click Toggle
- New Script Custom Script Force Release Toggle
- New Script Custom Script Silent Click Toggle
- New Script Custom Script Silent Release Toggle

##### Bugfix

- "New" correctly assigns the Main Gui windows size and state
- Device Output Node does not delete input source nodes on invalid input values anymore
- Node Connection now works only for visible Nodes
- XY Panel now loads correctly
- If project has joystick nodes and this project is loaded while no joystick is connected no error is thrown anymore.
- Splashscreen does not show any transparency anymore
- Mouse-click on empty user interface space in run mode does not affect nodes mute status anymore

#### Rev 55

##### Bugfix

- Artnet Output Node Reload fixed
- Serial Link Output Node Reload fixed

#### Rev 54

##### Features

- New Keyboard Shortcut Alt+C to toggle Custom Nodes in Menu
- New Custom Input Node CDS Automation Input
- New Custom Node Category, Custom Nodes are dedicated nodes created on demand to integrate customized hardware or interfaces.
- New Label Output Node
- New Relative parameters on Sensorlink Input Node

##### Bugfix

- Artnet Output on reload project fixed
- Artnet Output Node Reload fixed
- Serial Link Output Node Reload fixed
- Cleanup of DeltaValues on TrackScan Delta
- Cleanup of DeltaValues on Sensor Link E1Delta and E2Delta
- Sensor Link E1Delta and E2Delta input fixed

#### Rev 52

##### Features

- TCP/UDP/COM Input nodes do return 0 by default and are visible for node patching
- New Midi Raw Message Node to send individual messages such as Midi Control and Program Change messages
- midi node dialogs accept only valid status bytes from 8-14
- optimized node connection drawing
- Backup IP and Domain to control a Master and Backup system simultaneously
- Script DeviceSetParam,1,1,Video Mode,Loop / Play / Pause / Stop are supported as well

##### Bugfix

- midi value output node 15bit repaired
- Select all and the delete key only works in Move Mode

#### Rev 51

##### Bugfix

- Fixed Load last Config option

#### Rev 50

##### BugFix

- fixed Artnet Input Node did crash on Channel Value above 255

#### Rev 49

##### Features

- New Damping Timed Node, setup damping time delay for values to trail
- New Dynamic Trigger Node, setup for Hold and Release Time acts like a Gate Filter
- New Text Input Panel to update Text Assets In PB by line or all Text
- All Scripts refined to use ID only on WD Controls
- New TrackScan Barcode Tape Scanner Input node
- New XY Panel Input Node to intercept XY Distance and Angle from XY Panel
- New MediaPanel input node to intercept Folder and File IDs from one or multiple Media Control Panels
- New Audio Input node with 3x Frequency Band Pass Filters and Volume Output
- SensorLink Node refinement, Delta Value of Encoder 1 & 2 are now available directly
- New Angle To Point Node to calculate Pan and Tilt Angle between to given XYZ Points
- Nodes are Disabled in Move mode, by clicking anywhere in the Gui in None Move mode Node are always reactivated
- New Fader Output Node allows to route values directly to GUI Fader
- New Timebased Counter Input Node with Bounce on/off setting
- New Midi Value Output Node for 7 or 15bit value output

- New Conversion Node Radians>Degree & Degree>Radians (usefull with Sin, Cos and Tan Nodes)
  - New Percent Node
  - New Sin Cos Tan ASin ACos ATan Nodes
  - New Floor & Ceiling Node returns the next highest or lowset integer number of an input value
  - New Log Node
  - New Abs Node
  - New Sqrt Node
  - New Modulo Node
  - New Power x^y Node
  - Video Loop option in Video Control Properties
  - New Script to loop Video Controls
  - Behringer BCF2000 Fader Board Implemented (BCF needs to learn the mapping of WD first)
  - Behringer BCD2000 implemented
  - USB Jog Shuttle Input Panel implemented
  - USB 84Key Input Panel implemented
  - USB 128Key Input Panel implemented
  - USB 58Key Input Panel implemented
  - New Script Keypress to emulate local Keyboard input via Script  
 The keys argument can specify any single key or any key combined with ALT, CTRL, or SHIFT (or any combination of those keys). Each key is represented by one or more characters, such as a for the character "a", or {ENTER} for the ENTER key.  
 To combine a key with SHIFT, precede the key code with + (plus sign).  
 To combine a key with CTRL, precede the key code with ^ (caret).  
 To combine a key with ALT, precede the key code with % (percent sign).  
 To specify repeating keys, use the form {key number}.  
 You must put a space between key and number.  
 For example, {LEFT 42} means "press the LEFT ARROW key 42 times";  
 {h 10} means "press 'h' 10 times."  
 The following table lists the codes that can be used to specify characters that are not displayed when you press the corresponding key (such as ENTER or TAB).
- |             |             |             |              |           |           |            |                        |                                   |
|-------------|-------------|-------------|--------------|-----------|-----------|------------|------------------------|-----------------------------------|
| BACKSPACE   | {BACKSPACE} | or {BS}     | BREAK        | {BREAK}   | CAPS LOCK | {CAPSLOCK} | CLEAR                  | {CLEAR}                           |
| DELETE      | {DELETE}    | or {DEL}    | DOWN ARROW   | {DOWN}    | END       | {END}      | ENTER (numeric keypad) | {ENTER}                           |
| ENTER       | ~, ESC      | {ESCAPE}    | or {ESC}     | HELP      | {HELP}    | HOME       | {HOME}                 | INS {INSERT}                      |
| LEFT ARROW  | {LEFT}      | NUM LOCK    | {NUMLOCK}    | PAGE DOWN | {PGDN}    | PAGE UP    | {PGUP}                 | RETURN {RETURN}                   |
| RIGHT ARROW | {RIGHT}     | SCROLL LOCK | {SCROLLLOCK} | TAB       | {TAB}     | UP ARROW   | {UP}                   | F1 through F15 {F1} through {F15} |
- optional Scrollbars as GUI property
  - Widget Scriptnames have changed to WD
  - Range Filer support limits as checkbox
  - ArtNet output Node
  - ArtNet output scripts
  - ArtNet output list Dialog in Connection Manager
  - Midi input enhanced new midimessage input to intercept any midimessage
  - Midi output scripts
  - Z-Order of controls is now stored and loaded
  - CITP optimized so that images can be overwritten during runtime
  - All image used in Widget designer can be changed in the file system during runtime
  - CITP download updates all Media Control Panels based on Folder Index
  - CITP download updates all full size button images based on Folder and File ID
  - all Dialogs open in parent screen center or worst case in the uperleft corner.



## Rev 39

## Features

- Dialogs open either in GUI center or control properties at mouse cursor
- Menu Shortcut changed and refined
- New skin built-in
- Serial Scripts obsolete but backwards compatible to REV20
- New ComPort Connection added to Connection Manager
- New iPhone Remote input for Mouse and Script interaction
- New iPhone Input Node to capture Multi-Touch input from iPhone via WD REMOTE
- Update to VNC Viewer Component implemented

## Rev 36

## Features

- prep new macros for PB Menu Remote commands to set IP and Output Resolution
- prep new Skinning

## Bugfix

- script udp sender works fine now

## Rev 34

## Features

- New Midi Input Node
- New Fader Input Node
- New Scripts Airscan Mouse properties
- New Scripts Node Enable/Disable

## Bugfix

- Node Management Cleanup
- "Application Start" Script now supports so called "Working directories", no need to create shortcuts to .exe files anymore!

## Rev 32

## Features

- Midi Script Input Mapping
- New Asymmetric Range Filter Node
- New Damping Filter Node
- New Joystick Input Node
- AirScan Mouse Control implemented
- MacroScripts support full PBA 4.1 Rev 3148 featureset
- Minimize Widget Designer option added in File Menu
- CITP Browser added, thumbnails available in Button properties
- New X&Y panel for relative and absolute value input
- WidgetEnable/Disable Script Command
- WidgetButtonClick Script Command
- WidgetCustomScriptClick Script Command
- WidgetLoad Script Command
- WidgetNew Script Command
- WidgetWait now based on seconds and works with faders - does not freeze anymore
- Videoplayer with Script control
- Webbrowser with Script control
- Get filepath button for scripts
- Macros implemented
- Keyboard shortcut layout added
- Custom Script Mouse Enter Timer Click Event added
- Custom Script Mouse Enter and Mouse Leave events
- Arrow Keys and PageUp/down added to Shortcuts for "Perfect Cue" remote support

## BugFix

- TCP/UDP/Serial Send now supports comma separated messages
- Delete Select All with Videoplayer Windows could cause crashes

- Delete VNC Panel could cause crashes
- Files with Umlaut does not fail to load config, files are currently ignored.
- Oem Key support for Unicode characters
- button transparency upon file load
- label transparency upon file load
- Top most Form does not block item property dialogs anymore

#### Rev17

##### Features

- Fader supports custom Background and Handle Images
- New Scale Tool
- Media Player FXList added to Std Buttons properties
- Label control supports different Font styles
- New Macro Fader up/down with incremental Value
- New Macro Fader set to value
- New Macro Fader Up/Down with time
- New KeyboardShortcut PageUp & PageDown to navigate thru pages
- New Startup Macro Script
- New Macro UDP Send Message
- New Macro TCP Connect to TCP Server, Send Message, Close TCP Connection
- New VNC Panel for customized VNC Multiview setups
- New Main Gui properties: Size, Location, Windowsstate and WindowStyle
- Snap to Grid to arrange controls
- Grid size settings dialog to adjust Gridsize in pixels
- Grid optimized to redraw Background properly in any windows state
- Commandline Startup Option "ViewerMode" hides all editable controls from user
- New vertical and horizontal Fader Control
- New Custom Script Button featuring custom button images and Macroscripts
- Macro Scripts for Network Remoting of Pandoras Box V4 Servers from LCD Menu Rev7 on
- New Align tools: Align Left, Right, Horizontal Center, Top, Bottom, Vertical Center
- Keyboard-shortcuts for align tools
- Import for Rev8 configuration files

##### Bugfix

- optimized draw control over grid on item move
- Select All with Ctrl+A works fine now
- Item properties on multiple pages is fixed

#### Rev9

##### Features

- Multiple item-property dialogs can be opened at once for copy and paste of settings
- Multi-Selection with ctrl+ mouse and mouse drag rubberband
- Selection is shown only in Move mode
- Delete Selection with DEL key
- Move Selection
- Ctrl+A selects all control of current page
- ESC, clears selection
- Copy & Paste of items within pages and from page to page
- Label Font and Colour Properties added
- Align tool for selection: Make items even horizontal or vertical

##### Bugfix

- Button Font size loads and save correctly
- Filefilter on main gui background image fixed
- Appcrash fixed that occurred on delete item while property windows is open and new values applied

#### Rev8

##### Bugfix

- Meshes(object) could not be assigned to layers, this works now.

- 
- Image property page, load images new filetype selection for bitmaps jpegs png and gifs
  - Gui BG Colour is now stored and loaded correctly

Rev7:

Features

- Load last config startup option

Bugfixes

- Store all Main Gui parameters in file
- Label Fontsize is now updated correctly on project load
- Reset Network Connection on Project load

Rev6: Initial Release of PB Widget Designer

## 18 SDK

The software development kit (SDK) including the PB Automation allows to integrate Pandoras Box interaction into your custom application. This can be realized with common programming languages such as Visual Basic scripts as well C# and C++.

The Pandoras Box Automation allows your custom program to control almost any aspect from the PB software, e.g. parameters on video or graphic layers, sequence values and content data. As the Pandoras Box clients are connected to the master system, they are controlled indirectly. The control parameters can be sent using the network protocols TCP and UDP.

This chapter is written for:

- software programmers who have little knowledge of Pandoras Box and want to integrate it into their application
  - Pandoras Box users who have little programming knowledge but need to write a custom application.
- Please have a look at the [Widget Designer](#)<sup>864</sup> too. One of the main purposes of Widget Designer is to enable users who do not have any programming skills, to create their own custom applications or interfaces. Widget Designer provides a graphical user interface and runtime environment. You can create user-controls such as faders, buttons, labels and many more and instantly use them without compiling any code. The PRO version allows to program visually with so called nodes. By simply connecting those visual control components you may create a dedicated interaction logic.

If you like to build your own custom application to interact with Pandoras Box, the following scenarios are possible.

### One user application - One Pandoras Box master system

One custom application with one integrated "PandorasAutomation.dll" sends and receives TCP or UDP commands to and from one Pandoras Box master system. A master system can be either a Pandoras Box Manager or a Pandoras Box Player / Server started in master mode. The product range is described [here](#)<sup>65</sup> in detail.

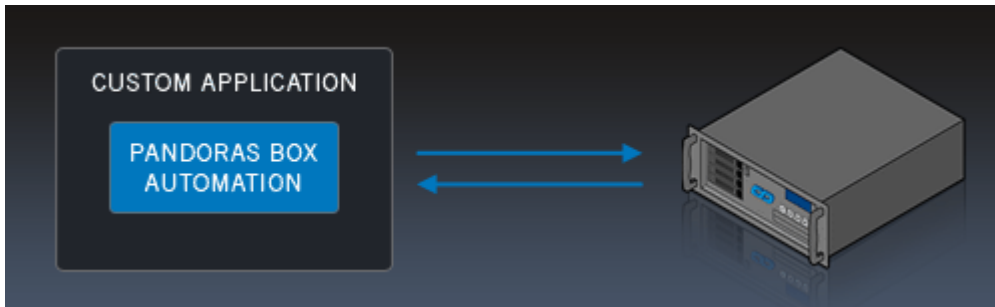

### One user application - Multiple Pandoras Box master systems

If you like to control more than one Pandoras Box master system with your program, easily duplicate the "PandorasAutomation.dll" as many times as you wish.

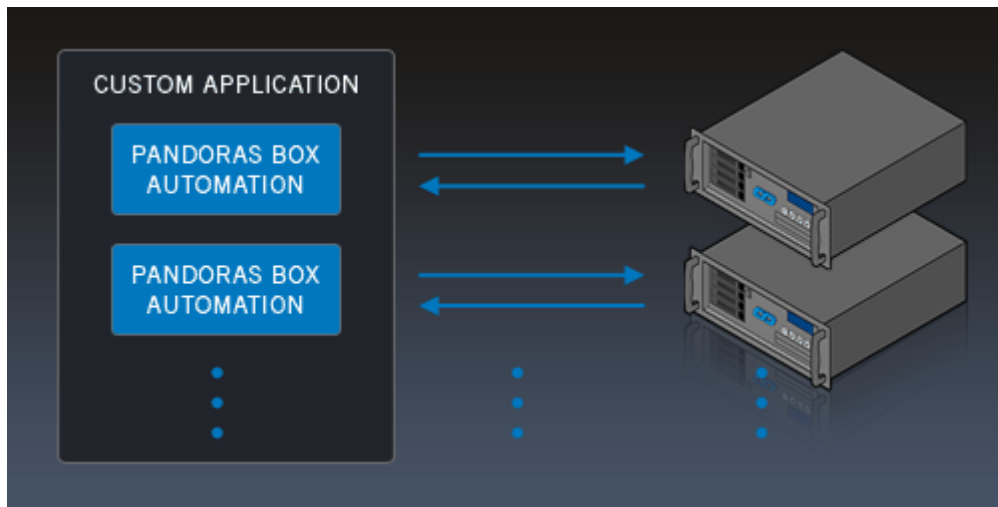

### Multiple user applications - One Pandoras Box master system

You can hook up as many applications to one Pandoras Box master system as you wish. The commands will work in LTP mode (latest takes precedence).

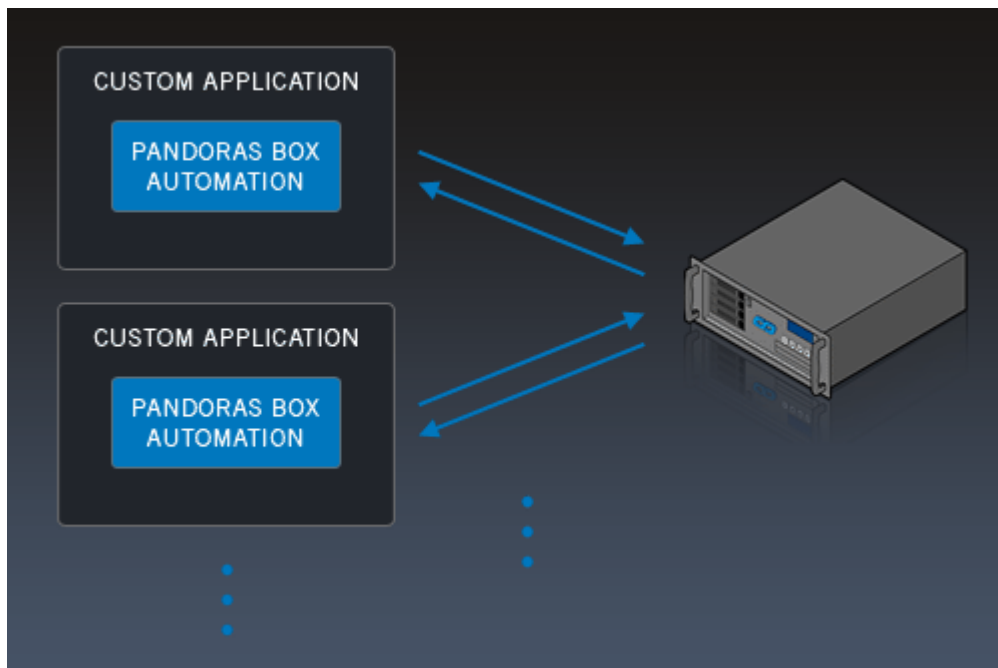

## Multiple user applications - Multiple Pandoras Box master systems

This scenario combines the one-to-many and the many-to-one scenario. Coolux does not set any limit regarding the application or PB master count.

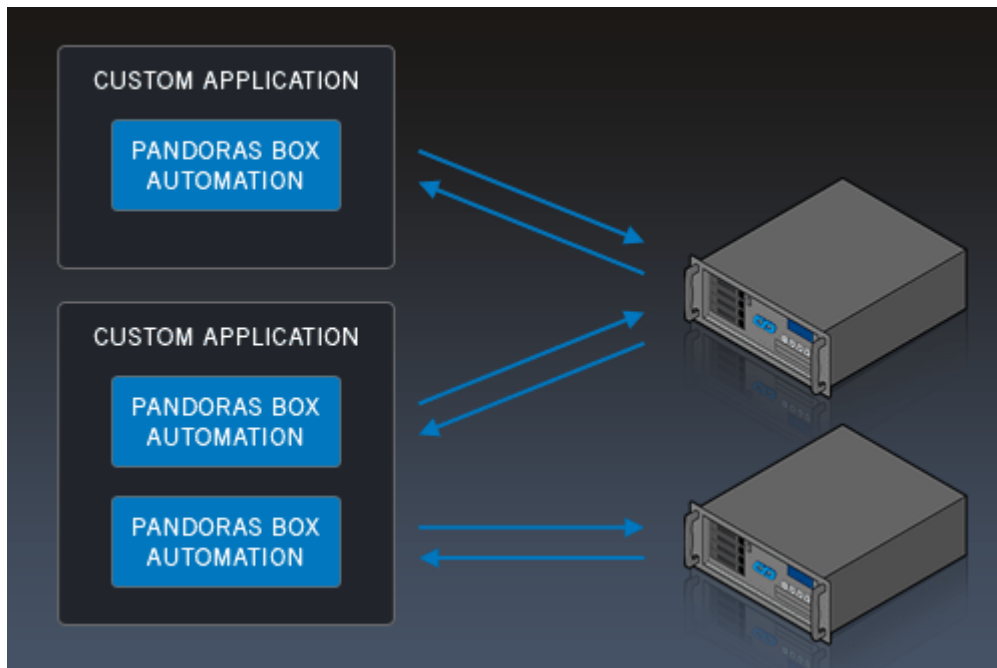

The following topics include a short [Getting Started](#)<sup>1534</sup>, some examples how to [connect the SDK to a PB system](#)<sup>1541</sup>, how to [send](#)<sup>1543</sup> and [receive](#)<sup>1544</sup> values as well as [typical error messages](#)<sup>1545</sup>. Afterwards the general [datatypes and structures](#)<sup>1545</sup> are explained and finally you find a list including [all available functions](#)<sup>1548</sup>.

### 18.1 Getting Started

Software Development Kits are available for the programming languages Visual Basic and C#. It is also possible to use JavaScript in Html pages. Other languages can also be used, but are not in the scope of this document.

We provide documented code for both Visual Basic and C# when used in combination with Visual Studio. You can obtain a copy of Visual Studio at the Microsoft website.

#### Required resources (Programming/Applications)

Step 1: Obtain PandorasAutomation.dll

You can find the PandorasAutomation.dll in every Pandoras Box installation folder (where PandorasBox.exe is located).

A typical location would be: C:/Program Files/coolux/Pandoras Box V5 ... Rev .../  
PandorasAutomation.dll

Step 2: [Download SDK](#)

Eventhough the SDK includes a PandorasAutomation.dll, it is recommended to substitute it with the one from the current version!

#### Required resources (Scripting/Html+JS)

All the required files come with Pandoras Box.

The next topic describes the steps to [get started with Visual Basic or C#](#)<sup>1535</sup>. For scripting with JavaScript read [Using JavaScript](#)<sup>1535</sup>. Information about [other languages can be found here](#)<sup>1537</sup>.

## 18.1.1 Using Visual Basic / C#

To get started with Visual Basic or C# please follow these steps.

### Installing the IDE (Integrated Development Environment)

To be able to convert the code you write to an actual executable program you will need a few tools. Fortunately, Microsoft provides all these tools bundled in one application called Visual Studio. Download Microsoft Visual Studio 2010 Express for Visual Basic or C#.

Download page: <http://microsoft.com/visualstudio/eng/downloads#d-2010-express>

Direct installer downloads: [Visual Basic](#) & [C#](#)

### Creating a project

After starting Visual Studio click **File > New** to create a new Project. Choose your project type (ex: **Console Application**) from the list and name it using the text box at the bottom. When the project has finished loading, you need to add the Pandoras Box SDK. Select **Project > Add Existing Item** from the top menu. Choose **PbAutomation.\*** in the file dialog. In case you have not previously downloaded it: [Download SDK](#)

### Adding PandorasAutomation.dll

After saving your project, open the Windows Explorer and navigate to your project's folder. There you will find a couple of directories. Put PandorasAutomation.dll in the following directory: <ProjectPath>/bin/Debug/

Now you are ready to use Pandoras Automation with Visual Basic. When exporting applications, make sure you keep PandorasAutomation.dll next to the application.exe

### Visual Basic Specific Information

The Visual Basic SDK provides an additional class to ease the workflow. The `Class Param` contains constants for the default parameter names (excluding effect parameters) used in all parameter functions.

### C# Specific Information

It is required by C# that all functions are within a class. That means, that all C# functions are in class `Auto` and instead of calling `Auto.GetContentIsConsistent(2,2)` you will have to put a dot in between `Auto` and the function name like this: `Auto.GetContentIsConsistent(2,2)`

When using `Auto.SetParamDouble` in combination with `enum TransportMode` you need to convert the enumerator to a `double` value.

Example (using [explicit cast](#)):

```
Auto.SetParamDouble(1,1,"Playback Transport",TransportMode.Pause) must be
changed to Auto.SetParamDouble(1,1,"Playback Transport", (double)
TransportMode.Pause)
```

## 18.1.2 Using JavaScript

This chapter assumes that you already have a little knowledge about Html and JavaScript.

### Setup of Pandoras Box web server

Open Pandoras Box and go to the Configuration tab. Choose Web Server from the categories list and change the settings as you like. Make sure to click the "Start" button as well. If you like, you can have a look at the demo pages which can be viewed from your web browser. Simply navigate to the IP address of your Pandoras Box Master using the port you previously set up in the Configuration tab.

URL example: Assuming your IP is 192.168.178.100 and the configured port is 6214:

<http://192.168.178.100:6214>

Once you are familiar with using Pandoras Box web server you can go ahead and write your own html. The only thing required to be included is the pandora.js In your header section use **<script type="text/javascript" src="web\_ui.js"></script>**

The web server utilizes the very same commands as all the other languages. To be able to retrieve data, all commands ask for a callback function as the first parameter. This mechanism is explained in the demo files.

### Using a dedicated web server

For advanced uses it is also possible to use a dedicated web server such as Apache to proxy the commands to Pandoras Box. We supplied a simple .php script for that. All you need to do is to change one line in pandora.js. Change "var usesProxy = false;" to "var usesProxy = true;"

### Example - Sequence Control

```
// The first parameter is the callback, which is described later on.
// The second parameter is the sequence id, which in our case is simply 1
// The third parameter describes the desired state, which can be "Play","Pause" or "Stop" (case-sensitive!)
// "Play"-button code is
```

```
PBAutoCommands.setSequenceTransportMode(false,1,'Play')
```

### Example - Retrieving Values

```
// callback_sequencemode is the callback (the function that is responsible to handle the incoming data)
PBAutoCommands.getSequenceTransportMode(callback_sequencemode,1)
```

```
function callback_sequencemode(response){

    // Quit if "false" is passed. That means that there is no response
    if(response === false) return;

    // Check for errors (On error, the first short is eAutoCmdError)
    if( && response.getNextAsShort() == eAutoCmdGetSequenceTransportMode){
        // Get the mode number
        var mode = response.getNextAsInt();
        var modeText = "???";
        // Translate numeric "mode" to text
        if(mode == 1) modeText = "Play";
        if(mode == 2) modeText = "Stop";
        if(mode == 3) modeText = "Pause";

        // Display
        document.getElementById("seq1mode").value = modeText;
    }
}
```



### 18.1.3 Other Languages

So far, we do not provide a complete SDK for other languages, but with a little knowledge you can use the PandorasAutomation.dll for them too. First, convert the following C++ export definitions to the language of choice in order to use the commands.

This list includes all commands PandorasAutomation.dll exports:

```

bool __stdcall AutoInitialize(char* pIpStr,int domain);
double __stdcall AutoGetParam(int siteNum,int deviceNum,char* pParamName);
bool __stdcall AutoSetParamInSelection(char* pParamName,int value);
bool __stdcall AutoSetParamInSelectiondouble(char* pParamName,double
value);
bool __stdcall AutoSetContentAtTime(int siteNum,int deviceNum,int
seqNum,int hours,int minutes,int seconds,int frames,int dmxFolderId,int
dmxId);
bool __stdcall AutoAssignMesh(int siteNum,int deviceNum,int dmxFolderId,int
dmxId);
bool __stdcall AutoAssignMeshByName(int siteNum,int deviceNum,char*
pMeshName,char* pParamName);
bool __stdcall AutoAssignMeshToSelection(int dmxFolderId,int dmxId);
bool __stdcall AutoAssignMedia(int siteNum,int deviceNum,int
dmxFolderId,int dmxId);
bool __stdcall AutoAssignMediaByName(int siteNum,int deviceNum,char*
pMediaName,char* pParamName);
bool __stdcall AutoAssignMediaToSelection(int dmxFolderId,int dmxId);
bool __stdcall AutoMoveContentToFolder(char*
pContentName,char*pFolderName);
bool __stdcall AutoMoveTreeItem(int itemIdFrom,int itemIdTo);
bool __stdcall AutoSetSequenceTransportMode(int sequenceNum,char*
pModeName);
bool __stdcall AutoMoveSequenceToCue(int sequenceNum,int cueId);
bool __stdcall AutoMoveSequenceToTime(int sequenceNum,int hours,int
minutes,int seconds,int frames);
bool __stdcall AutoMoveSequenceToLastNextFrame(int sequenceNum,bool
isNext);
bool __stdcall AutoMoveSequenceToLastNextCue(int sequenceNum,bool isNext);
bool __stdcall AutoSetSequenceTransparency(int seqNum,int transparency);
int __stdcall AutoGetSequenceTransparency(int seqNum);
bool __stdcall AutoSetSequenceTimeCodeMode(int seqNum,int timeCodeMode);
bool __stdcall AutoSetSequenceTimeCodeOffset(int seqNum,int hours,int
minutes,int seconds,int frames);
bool __stdcall AutoSetSequenceTimeCodeStopAction(int seqNum,int
stopAction);
bool __stdcall AutoResetAll();
bool __stdcall AutoResetSite(int siteNum);
bool __stdcall AutoResetDevice(int siteNum,int deviceNum);
bool __stdcall AutoResetParam(int siteNum,int deviceNum,char* pParamName);
bool __stdcall AutoActivateAll();
bool __stdcall AutoActivateSite(int siteNum);
bool __stdcall AutoActivateDevice(int siteNum, int deviceNum);
bool __stdcall AutoActivateParam(int siteNum,int deviceNum,char*
pParamName);
bool __stdcall AutoClearAllActive();
bool __stdcall AutoClearActiveSite(int siteNum);
bool __stdcall AutoClearActiveDevice(int siteNum,int deviceNum);
bool __stdcall AutoClearActiveParam(int siteNum,int deviceNum,char*
pParamName);

```

```

bool __stdcall AutoToggleFullscreen(int siteNum);
bool __stdcall AutoSetParamRelative(int siteNum,int deviceNum,char*
pParamName,int value);
bool __stdcall AutoSetParamRelativedouble(int siteNum,int deviceNum,char*
pParamName,double value);
bool __stdcall AutoSetParamRelativedoubleExtended(int siteNum,int
deviceNum,char* pParamName,double value,bool silent,bool direct);
bool __stdcall AutoSetParamRelativeInSelection(char* pParamName,int value);
bool __stdcall AutoSetParamRelativeInSelectiondouble(char*
pParamName,double value);
bool __stdcall AutoAddContent(char* pFullPath,int siteNum,int
dmxFolderId,int dmxId);
bool __stdcall AutoAddContentToFolder(char* pFullPath,int siteNum,int
dmxFolderId,int dmxId,char* pFoldername);
bool __stdcall AutoAddContentToTreeItem(char* pFullPath,int siteNum,int
dmxFolderId,int dmxId,int treeItemId);
bool __stdcall AutoAddContentFromLocalNode(char* pFullPath);
bool __stdcall AutoAddContentFromLocalNodeToFolder(char* pFullPath,char*
pFoldername);
bool __stdcall AutoAddContentFromLocalNodeToTreeItem(char* pFullPath,int
treeItemId);
bool __stdcall AutoAddContentFolder(char* pFolderPath,int siteNum,int
dmxFolderId,int dmxId,char* pProjectPath);
bool __stdcall AutoAddContentFolderFromLocalNode(char* pFolderPath);
bool __stdcall AutoAddContentFolderFromLocalNodeToFolder(char*
pFolderPath,char* pFoldername);
bool __stdcall AutoAddContentFolderFromLocalNodeToTreeItem(char*
pFolderPath,int treeItemId);
bool __stdcall AutoRemoveMediaById(int dmxFolderId,int dmxId);
bool __stdcall AutoRemoveMeshById(int dmxFolderId,int dmxId);
bool __stdcall AutoRemoveContentByName(char* pProjectPath,bool
allEquallyNamed);
bool __stdcall AutoRemoveTreeItem(int treeItemId);
bool __stdcall AutoRemoveAllResources(bool removeFolder);
bool __stdcall AutoSpreadAll();
bool __stdcall AutoSpreadMediaById(int dmxFolderId,int dmxId);
bool __stdcall AutoSpreadMeshById(int dmxFolderId,int dmxId);
bool __stdcall AutoReloadMediaById(int dmxFolderId,int dmxId);
bool __stdcall AutoReloadMeshById(int dmxFolderId,int dmxId);
bool __stdcall AutoReloadResource(char* pProjectPath);
bool __stdcall AutoSpreadResource(char* pProjectPath);
bool __stdcall AutoReloadAndSpreadResourceByPath(char* pProjectPath);
bool __stdcall AutoReloadAndSpreadResourceByItemIndex(int treeItemId);
bool __stdcall AutoReloadAndSpreadResourceByDmxId(int dmxFolderId,int
dmxId);
bool __stdcall AutoRemoveInconsistent();
bool __stdcall AutoStoreActive(int seqNum);
bool __stdcall AutoStoreActiveToTime(int seqNum,int hours,int minutes,int
seconds, int frames);
bool __stdcall AutoSetMediaFrameBlendingById(int dmxFolderId,int dmxId,bool
frameBlended);
bool __stdcall AutoSetMediaDeinterlacingById(int dmxFolderId,int dmxId,int
deinterlacer);
bool __stdcall AutoSetMediaAnisotropicFilteringById(int dmxFolderId,int
dmxId,bool useFiltering);
bool __stdcall AutoSetMediaUnderscanById(int dmxFolderId,int dmxId,bool
useUnderscan);

```

```

bool __stdcall AutoSetMediaMpegColourSpaceById(int dmxFolderId,int
dmxId,bool useMpegColourSpace);
bool __stdcall AutoSetMediaAlphaChannelById(int dmxFolderId,int dmxId,bool
useAlphaChannel);
bool __stdcall AutoCreateTextInput(int dmxFolderId,int dmxId,char* pText);
bool __stdcall AutoSetText(int dmxFolderId,int dmxId,char* pText);
bool __stdcall AutoLoadProject(char* pPath,char* pName,bool saveExisting);
bool __stdcall AutoCloseProject(bool save);
bool __stdcall AutoClearSelection();
bool __stdcall AutoSetDeviceAcceptDmxById(int siteNum,int deviceNum,bool
acceptDmx);
bool __stdcall AutoSetSiteAcceptDmxById(int siteNum,bool acceptDmx);
bool __stdcall AutoSetDeviceDmxAddressById(int siteNum,int deviceNum,int
index,int id1,int id2);
bool __stdcall AutoSetSequenceCuePlayMode(int seqNum,int cueId,int
playMode);
bool __stdcall AutoSetNextSequenceCuePlayMode(int seqNum,int playMode);
bool __stdcall AutoSetIgnoreNextSequenceCue(int seqNum,bool doIgnore);
bool __stdcall AutoSetChannelEvents(int ctEvents,int* pEvents);
bool __stdcall AutoSaveProject();
bool __stdcall AutoChangeFullscreenStateById(int siteNum,bool
enterFullscreen);
bool __stdcall AutoChangeFullscreenStateByIp(char* pIp,bool
enterFullscreen);
bool __stdcall AutoSetTextTextureSize(int dmxFolderId,int dmxId,int
width,int height);
bool __stdcall AutoSetTextProperties(int dmxFolderId,int dmxId,char*
pFont,int size,int style,int alignment,int colorRed,int colorGreen,int
colorBlue);
bool __stdcall AutoSetTextCenterOnTexture(int dmxFolderId,int dmxId,bool
centerOnTexture);
bool __stdcall AutoCreateTextInputWide(int dmxFolderId,int dmxId,wchar_t*
pText);
bool __stdcall AutoSetTextWide(int dmxFolderId,int dmxId,wchar_t* pText);
bool __stdcall AutoSetSiteIpById(int siteNum,char* pIp);
bool __stdcall AutoIsLayerReallySelected(int siteNum,int deviceNum);
int __stdcall AutoGetNumMediaInProject();
int __stdcall AutoGetNumTreeItemsInProject();
bool __stdcall AutoGetMediaInfo(int index,MediaStruct* pMediaInfo);
bool __stdcall AutoGetMediaInfo1(int index,MediaStruct1* pMediaInfo);
bool __stdcall AutoGetMediaInfoFromTreeItem(int treeItemIndex,MediaStruct1*
pMediaInfo);
bool __stdcall AutoGetTreeItemInfo(int index,TreeItemStruct* pItemInfo);
int __stdcall AutoGetSequenceTransportMode(int seqNum);
bool __stdcall AutoGetSequenceTime(int seqNum,TimeStruct* pTime);
bool __stdcall AutoGetClipRemainingTime(int siteNum,int deviceNum,int
seqNum,TimeStruct* pTime);
bool __stdcall AutoGetRemainingTimeUntilNextCue(int seqNum,TimeStruct*
pTime);
int __stdcall AutoGetNumSelectedLayers();
bool __stdcall AutoGetSelectedLayer(int layerIndex,LayerStruct* layerInfo);
bool __stdcall AutoAddFolderToProject(char* pName);
bool __stdcall AutoAddFolderToProjectPath(char* pName, char* pFolderRoot);
bool __stdcall AutoAddFolderToTreeItem(char* pName,int treeItemId);
bool __stdcall AutoRemoveFolderFromProject(char* pFolderPath);
bool __stdcall AutoSetDeviceSelection(int siteNum,int deviceNum,int
selectionMode);

```

```

bool __stdcall AutoSetClxControllerFaderMapping(int faderId,int seqNum);
bool __stdcall AutoSetClxControllerCueMapping(int cueBtnId,int seqNum,int
cueId);
bool __stdcall AutoAddCue(int seqNum,int cueId,int hours,int minutes,int
seconds,int frames,char* pName,int cueKindId);
bool __stdcall AutoRemoveCueById(int seqNum,int cueId);
bool __stdcall AutoRemoveAllCues(int seqNum);
int __stdcall AutoAddGraphicLayer(int siteId);
int __stdcall AutoAddVideoLayer(int siteId);
bool __stdcall AutoRemoveGraphicLayer(int siteId,int layerId);
bool __stdcall AutoRemoveVideoLayer(int siteId,int layerId);
bool __stdcall AutoBackupMode(bool enable);
bool __stdcall AutoApplyView(int viewNum);
bool __stdcall AutoSetSpareFromSpread(int siteId,bool spareFromSpread);
bool __stdcall AutoGetParamMedia(int siteNum,int deviceNum,char*
pParamName,ParamResStruct* pInfo);
bool __stdcall AutoGetParamMedia1(int siteNum,int deviceNum,char*
pParamName,ParamResStruct1* pInfo);
bool __stdcall AutoGetParamObject(int siteNum,int deviceNum,char*
pParamName,ParamResStruct* pInfo);
bool __stdcall AutoGetParamObject1(int siteNum,int deviceNum,char*
pParamName,ParamResStruct1* pInfo);
bool __stdcall AutoAddMediaIncrementID(char* pMediaPath,int
siteNum,ParamResStruct* pInfo);
bool __stdcall AutoGetMediaTransportMode(int siteNum,int deviceNum,int*
pTransportMode);
bool __stdcall AutoIsSiteConnected(int siteNum);
bool __stdcall AutoMoveLayerUp(int siteNum,int deviceNum);
bool __stdcall AutoMoveLayerDown(int siteNum,int deviceNum);
bool __stdcall AutoMoveLayerToFirstPosition(int siteNum,int deviceNum);
bool __stdcall AutoMoveLayerToLastPosition(int siteNum,int deviceNum);
bool __stdcall AutoSetEnableClxJogShuttle(bool enable);
bool __stdcall AutoGetEnableClxJogShuttle();
bool __stdcall AutoSetEnableClxFaderExt(bool enable);
bool __stdcall AutoGetEnableClxFaderExt();
bool __stdcall AutoSetSequenceCueWaitTime(int seqNum,int cueId,int
hours,int minutes,int seconds,int frames);
bool __stdcall AutoSetSequenceCueJumpTargetTime(int seqNum,int cueId,int
hours,int minutes,int seconds,int frames);
bool __stdcall AutoSetSequenceCueJumpCount(int seqNum,int cueId,int
jumpCount);
bool __stdcall AutoResetSequenceCueTriggerCount(int seqNum,int cueId);
int __stdcall AutoGetContentIsConsistent(int dmxFolderId,int dmxId);
int __stdcall AutoGetContentIsConsistentByName(char* pProjectPath);
int __stdcall AutoCreateSequence();
bool __stdcall AutoRemoveSequence(int seqNum);
bool __stdcall AutoGetIsConnected();
bool __stdcall AutoSendMouseInput(int siteNum,int eventType,int
screenPosX,int screenPosY,int screenWidth,int screenHeight);
bool __stdcall AutoSendTouchInput(int siteNum,int touchId,int touchType,int
screenPosX,int screenPosY,int screenWidth,int screenHeight);
bool __stdcall AutoSendKeyboardInput(int siteNum,int eventType,int
keyCode);
bool __stdcall AutoSetShowCursorInFullscreen(int siteNum,bool showCursor);
bool __stdcall AutoSetNodeOfSiteIsAudioClockMaster(int siteNum,bool
isMaster);
bool __stdcall AutoGetThumbnailByPath(char* pProjectPath,int* pWidth,int*

```

```

pHeight, VARIANT* pData);
bool __stdcall AutoGetThumbnailByItemIndex(int treeItemIndex, int*
pWidth, int* pHeight, VARIANT* pData);
bool __stdcall AutoAddEncryptionKey(char* pKey);
bool __stdcall AutoAddEncryptionPolicy(char* pPolicy);
int __stdcall AutoGetLastError();

```

## 18.2 Examples

The following topics contain quick tutorials explaining the basic functionality of Pandoras Box Automation. They assume that you have already set up your programming environment and have added one of the SDKs to the project (as explained in [Getting Started](#)<sup>1534</sup>).

To continue, go to [Connect SDK to Pandoras Box](#)<sup>1541</sup>

### 18.2.1 Connect SDK to Pandoras Box

#### TCP versus UDP

The Pandoras Automation allows both, TCP and UDP connections. Both protocols allow sending data via a network connection. The ports that are used are 6211 for TCP and 6212 for UDP whilst the ports used for the TCP and UDP communication between a PB master and PB client are 1234 and 1235.

TCP has the advantage, that all packages are guaranteed to be delivered. To make that possible, TCP requires to send additional data, the so called acknowledge bits. The message sender asks the receiver for an acknowledge bit. If the receiver does not confirm, the message is send again. In addition TCP ensures the correct order of message packages. This is done by the network adapter; if packages are received in non-chronological order, it buffers the packages. The downside is, that the connection gets slower. The disadvantage of the acknowledging process is to be found when very large amounts of data is send as more network traffic is caused. Most sensors, for example send a lot of data, thus TCP would not be the protocol of choice. It is a different matter when you need to send "important" data and want to be sure that it arrives.

In short, decide for a TCP connection if the applications are connected in a stable network (by cable) and react to user interaction by sending a manageable amount of commands to PB Automation. When using TCP you can choose between automatic mode which will automatically reconnect or a "try once".

UDP is a better choice in scenarios where a lot of data is sent, or in case packages do not necessarily need to be acknowledged. In the UDP protocol the server does not know whether the clients received the messages, it rather sends the messages "blind". This way, UDP offers a faster response time for your application. The main disadvantage from a UDP protocol is that UDP packages are not as prioritized as TCP data. Thus each switch in the network may discard UDP data without further notice as soon as the network traffic reaches its limit.

In short, decide for a UDP connection if the application is allowed to get disconnected from the master for short periods of time. Also, UDP is the better choice for applications that are updating values permanently, like in tracking systems or systems with permanent user interaction.

The following commands are needed to initialize the connection. The commands are listed with an example, assuming the master system runs on a certain IP address and is set up with a certain domain number. The IP address can be found in the [Asset tab](#)<sup>137</sup> of the PB software, the domain channel is a Pandoras Box internal number set up in the [Configuration tab](#)<sup>139</sup>.

### Initializing TCP

Make sure you configured (or disabled) your firewall to allow your application to communicate with Pandoras Box.

Initialize the connection to the Pandoras Box master running at IP 10.0.0.1 with Domain number 0. The third parameter allows to choose between

- False: instantly try to connect once
- True: wait and connect as soon as possible

Setting "waitForConnection" to True also enables automatic reconnecting on connection loss.

Note: You can later on enable the "waitForConnection" feature by using `AutoWaitForConnection()` and disable it by using `AutoStopWaitingForConnection()`

#### ▼Visual Basic

```
AutoInitializeTCP("10.0.0.1", 0, True)
```

#### ▼C#

```
Auto.InitializeTCP("10.0.0.1", 0, true);
```

### Initializing UDP connections

Initialize the connection to Pandoras Box Master running at IP 10.0.0.1 with Domain number 0.

Pandoras Automation will try to connect to Pandoras Box and verify the connection with a handshake.

#### ▼Visual Basic

```
AutoInitialize("10.0.0.1", 0)
```

#### ▼C#

```
Auto.Initialize("10.0.0.1", 0);
```

Now that you are connected to Pandoras Box, you can start [Sending Parameter Values](#)<sup>1543</sup>.

## 18.2.2 Sending Parameter Values

The following examples show you how to set parameter values from Pandoras Box using the [SDK](#)<sup>1532</sup>. The examples require a working connection to Pandoras Box. (see [Connect SDK to Pandoras Box](#)<sup>1541</sup>)

### ▼Visual Basic

```
' Set the opacity of layer 3 of site 2 to 240.
' The parameter will be marked active and transition smoothing applies
AutoSetParamDouble(2, 3, Param.Opacity, 240)

' Set the x position of layer 1 of site 2 to -2 without setting the value
active.
' Use Transition Smoothing
AutoSetParamDoubleExtended(2, 1, Param.Position.X, -2, True, False)

' Set the x position of layer 1 of site 2 to -2 and set value as active.
' Do not use Transition Smoothing
AutoSetParamDoubleExtended(2, 1, Param.Position.X, -2, False, True)

' Set the Mix parameter of the "White Key" effect on layer 1 of site 2 to a
value of 255
AutoSetParamDouble(2, 1, "White Key|Mix", 255)
```

### ▼C#

```
// Set the opacity of layer 3 of site 2 to 240.
// The parameter will be marked active and transition smoothing applies
Auto.SetParamDouble(2, 3, "Opacity", 240)

// Set the x position of layer 1 of site 2 to -2 without setting the value
active.
// Use Transition Smoothing
Auto.SetParamDoubleExtended(2, 1, "X Pos", -2, True, False)

// Set the x position of layer 1 of site 2 to -2 and set value as active.
// Do not use Transition Smoothing
Auto.SetParamDoubleExtended(2, 1, "X Pos", -2, False, True)

// Set the Mix parameter of the "White Key" effect on layer 1 of site 2 to
a value of 255
Auto.SetParamDouble(2, 1, "White Key|Mix", 255)
```

If you are not familiar with Pandoras Box "vocabulary", please follow the links. In short, a site refers to a client e.g. a server, in the [Device Tree tab](#)<sup>168</sup>. A site has many devices, also called layers, e.g. [graphic layers](#)<sup>577</sup> or [video layers](#)<sup>298</sup>. A video layer has many parameters, e.g. [position](#)<sup>304</sup> on the X-axis. If a new value is applied to the parameters position / rotation / scaling, the layer would abruptly jump to it, which, does not look nice. Therefore, "Smoothing" applies a delay. It can be set up in the [Device Inspector](#)<sup>206</sup>. Other examples above refer to parameters "effects", more information about effects can be found in the tab [Aeon FX](#)<sup>136</sup> and [FX on Layers](#)<sup>319</sup>, including an illustrated [FXList](#)<sup>328</sup> with all available effects. A [list with all parameter names](#)<sup>1256</sup> can be found here.

The next topic informs you about [Receiving Parameter Values](#)<sup>1544</sup> from Pandoras Box.

## 18.2.3 Receiving Parameter Values

The following examples show you how to request information from Pandoras Box using the [SDK](#)<sup>1532</sup> and how to handle incoming values.

The examples require a working connection to Pandoras Box (see [Connect SDK to Pandoras Box](#))<sup>1541</sup>. If you like to know, how to send values yourself please go back to the topic [Sending Parameter Values](#)<sup>1543</sup>)

### ▼Visual Basic

```
' Get the Y position of layer 1 of site 2
Dim y_pos As Double = AutoGetParam(2, 1, Param.Position.Y)

' Get the "Left" parameter value of effect "Crop Edges" on layer 3 of site 1
Dim crop_edges_left As Double = AutoGetParam(1, 3, "Crop Edges|Left")

' Get the transport mode of sequence 2 (Play/Stop/Pause)
Dim sequence_status As TransportMode = AutoGetSequenceTransportMode(2)

' Get the current time position of sequence 1 and extract the number of seconds
Dim sequence_time As TimeType
AutoGetSequenceTime(1, sequence_time)
Dim sequence_seconds As Integer = sequence_time.Seconds
```

### ▼C#

```
// Get the Y position of layer 1 of site 2
double y_pos = AutoGetParam(2, 1, "Pos Y")

// Get the "Left" parameter value of effect "Crop Edges" on layer 3 of site 1
double crop_edges_left As Double = AutoGetParam(1, 3, "Crop Edges|Left")

// Get the transport mode of sequence 2 (Play/Stop/Pause)
TransportMode sequence_status = Auto.GetSequenceTransportMode(2);

// Get the current time position of sequence 1 and extract the number of seconds
TimeType sequence_time = new TimeType();
Auto.GetSequenceTime(1, ref sequence_time);
int sequence_seconds = sequence_time.Seconds;
```

If you are not familiar with Pandoras Box "vocabulary", please follow the links. In short, a site refers to a client e.g. a server, in the [Device Tree tab](#)<sup>168</sup>. A site has many devices, also called layers, e.g. [graphic layers](#)<sup>577</sup> or [video layers](#)<sup>298</sup>. A video layer has many parameters, e.g. [position](#)<sup>304</sup> on the X-axis. If a new value is applied to the parameters position / rotation / scaling, the layer would abruptly jump to it, which, does not look nice. Therefore, "Smoothing" applies a delay. It can be set up in the [Device Inspector](#)<sup>206</sup>. Other examples above refer to parameters "effects", more information about effects can be found in the tab [Aeon FX](#)<sup>136</sup> and [FX on Layers](#)<sup>319</sup>, including an illustrated [FXList](#)<sup>328</sup> with all available effects. A [list with all parameter names](#)<sup>1256</sup> can be found here.

The next topic, [Error Handling](#)<sup>1545</sup>, covers the way the SDK reports problems.



## 18.2.4 Error Handling

Whilst using the [SDK](#)<sup>1532</sup>, e.g. [sending](#)<sup>1543</sup> and [receiving](#)<sup>1544</sup> parameter values you might encounter problems.

The following function for error handling works only for functions which are not returning information directly. All other functions return a value true or false. If "false" was returned, you can get the type of problem with the function `AutoGetLastError()`

### ▼Visual Basic

```
// Store the error code in "error_code" and store a string describing the
error in "error_text"
Dim error_code As AutoError = AutoGetLastError()
Dim error_text As String = error_code.ToString()
```

### ▼C#

```
// Store the error code in "error_code" and store a string describing the
error in "error_text"
AutoError error_code = Auto.GetLastError();
string error_text = error_code.ToString();
```

## 18.3 Datatypes and Structures

This topic lists all available datatypes and their structures that are used by the [SDK](#)<sup>1532</sup>. Please see the next topic for all available [functions](#)<sup>1548</sup>.

**Enumeration AutoError** - Contains the error codes which describe the problem that occurred

None = 0 ' No Error occurred  
 NoConnection = 1 ' Automation is not connected  
 WrongParam = 2 ' You have supplied a invalid parameter name (exceeded 100 characters)  
 AddressTranslation = 3 ' There seems to be a problem with the IP/Host you supplied  
 CouldNotConnectToSocket = 4 ' Failed to open a port for communication  
 HandshakeFailed = 5 ' The handshake was unsuccessful. For UDP connections: Make sure the connection is stable  
 RequestTimedOut = 6 ' The site failed to respond  
 WrongMessageReturned = 7 ' The server returned a wrong message  
 ParamPointer = 8 ' Make sure you supplied all of the required arguments  
 WrongClient = 9 ' unused  
 HostInvalidLayer = 10 ' You supplied an invalid layer id  
 HostInvalidSequence = 11 ' You supplied an invalid sequence  
 HostInvalidPointer = 12 ' You supplied an invalid pointer  
 HostInvalidParameterName = 13 ' You supplied an invalid pointer name  
 HostInvalidParam = 14 ' You supplied an invalid parameter  
 InvalidPort = 15 ' Failed to connect to the master  
 WrongNetworkProtocol = 16 ' unused  
 AlreadyConnected = 17 ' Failed to connect because the connection is already established  
 InvalidCueId = 18 ' You supplied an invalid cue  
 InvalidCueButtonId = 19 ' You supplied an invalid button id  
 InvalidDomainNr = 20 ' You supplied an invalid domain number  
 GraphicLayerNotCreated = 21 ' Failed to create a new graphics layer  
 InvalidSiteId = 22 ' You supplied an invalid site id

InvalidViewId = 23 ' You supplied an invalid view id  
InvalidCast = 24 ' (deprecated)  
AddingVideoLayerNotAllowed = 25 ' Unable to add more video layers  
InvalidLayerMoveTarget = 26 ' (deprecated)  
InvalidFolderPath = 27 ' (deprecated)  
DmxResourceNotFound = 28 '  
NoAdditionalSequenceAllowed = 29  
InvalidContentPath = 30  
HandshakeTimeout = 31  
FunctionNotSupportedByOS = 32 ' unused  
TreeltemIndexNoMediaFile = 33 '  
TreeltemNotFound = 34 ' The tree item was not found  
InvalidTreeltemIndex = 35 ' The tree item was not found  
NoThumbnailAvailable = 36 ' Indicates, that no thumbnail is available  
EncryptionKeyNotValid = 37  
EncryptionPolicyNotValid = 38  
NoEncryptionManager = 39

**Enumeration SequenceTimeCodeMode** - Contains the codes for timecode modes

None = 0  
Send = 1  
Receive = 2

**Enumeration SequenceTimeCodeStopAction** - Contains the codes which determine what to do after a SMPTE timecode stop

None = 0  
Stop = 1  
Pause = 2  
Continue = 3

**Enumeration TransportMode** - Contains the codes for play/pause/stop/playloop

Stop = 0  
Pause = 128  
Play = 64  
PlayLoop = 192

**Enumeration CuePlayMode** - Contains the cue types (play,pause,stop,jump,wait)

Play = 0  
Pause = 1  
Stop = 2  
Jump = 3  
Wait = 4

**Structure TimeType** - Is used for functions that return time information

VersionNum As Integer  
Hours As Integer  
Minutes As Integer

---

Seconds As Integer  
Frames As Integer

**Structure MediaOptionsType** - Contains options for media assets

anisotropicFiltering As Boolean  
ignoreThumbnail As Boolean  
alphaChannel As Boolean  
fluidFrame As Boolean  
optimizeMpegColorspace As Boolean  
underscan As Boolean  
optimizeLooping As Boolean  
muteSound As Boolean

**Structure MediaType1** - Contains information on media assets ("MediaType" is for legacy support)

dmxId As Integer  
dmxFolderId As Integer  
path As Byte()  
projectPath As Byte()  
width As Integer  
height As Integer  
fps As Integer  
Length As TimeType  
options As MediaOptionsType

**Structure LayerType** - Contains site and device number of a layer

VersionNum As Integer  
siteNum As Integer  
deviceNum As Integer

**Structure ParamResourceType1** - Contains information about a resource ("ParamResourceType" is for legacy support)

folderId As Integer  
fileId As Integer  
path As Byte()  
projectPath As Byte()

**TreeItemType** - Contains information about a tree item

projectPath As Byte()  
idPath As Byte()  
type As Integer

## 18.4 Function Reference

This topic lists all functions that are available in the [SDK](#)<sup>1532</sup>. A list with the exact parameter names can be found [here](#)<sup>1256</sup>.

[AutoInitialize\(lpStr As String, domain As Integer\)](#)<sup>1553</sup>

[AutoInitializeTCP\(lpStr As String, domain As Integer, waitForConnection As Boolean\)](#)<sup>1554</sup>

[AutoUnInitialize \(\)](#)<sup>1554</sup>

[AutoWaitForConnection \(\)](#)<sup>1554</sup>

[AutoStopWaitingForConnection \(\)](#)<sup>1554</sup>

[AutoGetIsConnected \(\)](#)<sup>1554</sup>

[AutoGetLastError \(\)](#)<sup>1555</sup>

[AutoSetParamDouble\(siteNum As Integer, deviceNum As Integer, ParamName As String, value As Double\)](#)<sup>1555</sup>

[AutoSetParamDoubleExtended\(siteNum As Integer, deviceNum As Integer, ParamName As String, value As Double, silent As Boolean, direct As Boolean\)](#)<sup>1555</sup>

[AutoSetParamInSelectionDouble\(ParamName As String, value As Double\)](#)<sup>1555</sup>

[AutoGetParam \(siteNum As Integer, deviceNum As Integer, ParamName As String\)](#)<sup>1555</sup>

[AutoSetContentAtTime \(siteNum As Integer, deviceNum As Integer, seqNum As Integer, hours As Integer, minutes As Integer, seconds As Integer, frames As Integer, dmxFolderId As Integer, dmxDId As Integer\)](#)<sup>1556</sup>

[AutoAssignMesh\(siteNum As Integer, deviceNum As Integer, dmxFolderId As Integer, dmxDId As Integer\)](#)<sup>1556</sup>

[AutoAssignMeshByName\(siteNum As Integer, deviceNum As Integer, MeshName As String, ParamName As String\)](#)<sup>1556</sup>

[AutoAssignMeshToSelection\(dmxFolderId As Integer, dmxDId As Integer\)](#)<sup>1556</sup>

[AutoAssignMedia\(siteNum As Integer, deviceNum As Integer, dmxFolderId As Integer, dmxDId As Integer\)](#)<sup>1557</sup>

[AutoAssignMediaByName\(siteNum As Integer, deviceNum As Integer, MediaName As String, ParamName As String\)](#)<sup>1557</sup>

[AutoAssignMediaToSelection\(dmxFolderId As Integer, dmxDId As Integer\)](#)<sup>1557</sup>

[AutoMoveContentToFolder\(ContentName As String, FolderName As String\)](#)<sup>1557</sup>

[AutoMoveTreeItem\(itemIdFrom As Integer, itemIdTo As Integer\)](#)<sup>1557</sup>

[AutoSetSequenceTransportMode\(sequenceNum As Integer, ModeName As String\)](#)<sup>1558</sup>

[AutoMoveSequenceToCue\(sequenceNum As Integer, cueId As Integer\)](#)<sup>1558</sup>

[AutoMoveSequenceToTime\(sequenceNum As Integer, hours As Integer, minutes As Integer, seconds As Integer, frames As Integer\)](#)<sup>1558</sup>

[AutoMoveSequenceToLastNextFrame\(sequenceNum As Integer, isNext As Boolean\)](#)<sup>1558</sup>

[AutoMoveSequenceToLastNextCue\(sequenceNum As Integer, isNext As Boolean\)](#)<sup>1558</sup>

[AutoSetSequenceTransparency\(seqNum As Integer, transparency As Integer\)](#)<sup>1559</sup>

[AutoGetSequenceTransparency \(seqNum As Integer\)](#)<sup>1559</sup>

[AutoSetSequenceTimeCodeMode\(seqNum As Integer, timeCodeMode As Param.SequenceTimeCodeMode\)](#)<sup>1559</sup>

[AutoSetSequenceTimeCodeOffset\(seqNum As Integer, hours As Integer, minutes As Integer, seconds As Integer, frames As Integer\)](#)<sup>1559</sup>

[AutoSetSequenceTimeCodeStopAction\(seqNum As Integer, stopAction As Param.SequenceTimeCodeStopAction\)](#)<sup>1559</sup>

[AutoResetAll \(\)](#)<sup>1560</sup>

[AutoResetSite\(siteNum As Integer\)](#)<sup>1560</sup>

[AutoResetDevice\(siteNum As Integer, deviceNum As Integer\)](#)<sup>1560</sup>

[AutoResetParam\(siteNum As Integer, deviceNum As Integer, ParamName As String\)](#)<sup>1560</sup>

[AutoActivateAll \(\)](#)<sup>1560</sup>

[AutoActivateSite\(siteNum As Integer\)](#)<sup>1561</sup>

[AutoActivateDevice\(siteNum As Integer, deviceNum As Integer\)](#)<sup>1561</sup>

[AutoActivateParam\(siteNum As Integer, deviceNum As Integer, ParamName As String\)](#)<sup>1561</sup>

[AutoClearAllActive \(\)](#)<sup>1561</sup>

[AutoClearActiveSite\(siteNum As Integer\)](#)<sup>1561</sup>

[AutoClearActiveDevice\(siteNum As Integer, deviceNum As Integer\)](#)<sup>1561</sup>

[AutoClearActiveParam\(siteNum As Integer, deviceNum As Integer, ParamName As String\)](#)<sup>1562</sup>

[AutoToggleFullscreen\(siteNum As Integer\)](#)<sup>1562</sup>

[AutoSetParamRelativeDouble\(siteNum As Integer, deviceNum As Integer, ParamName As String, value As Double\)](#)<sup>1562</sup>

[AutoSetParamRelativeDoubleExtended\(siteNum As Integer, deviceNum As Integer, ParamName As String, value As Double, silent As Boolean, direct As Boolean\)](#)<sup>1562</sup>

[AutoSetParamRelativeInSelectionDouble \(ParamName As String, value As Double\)](#)<sup>1563</sup>

[AutoAddContent\(FullPath As String, siteNum As Integer, dmxFolderId As Integer, dmXId As Integer\)](#)<sup>1563</sup>

[AutoAddContentToFolder\(FullPath As String, siteNum As Integer, dmxFolderId As Integer, dmXId As Integer, Foldername As String\)](#)<sup>1563</sup>

[AutoAddContentToTreeItem\(FullPath As String, siteNum As Integer, dmxFolderId As Integer, dmXId As Integer, treeItemId As Integer\)](#)<sup>1563</sup>

[AutoAddContentFromLocalNode \(FullPath As String\)](#)<sup>1563</sup>

[AutoAddContentFromLocalNodeToFolder\(FullPath As String, Foldername As String\)](#)<sup>1564</sup>

[AutoAddContentFromLocalNodeToTreeltem\(FullPath As String, treeltemId As Integer\)](#)<sup>1564</sup>

[AutoAddContentFolder\(FolderPath As String, siteNum As Integer, dmxFolderId As Integer, dmxId As Integer, ProjectPath As String\)](#)<sup>1564</sup>

[AutoAddContentFolderFromLocalNode\(FolderPath As String\)](#)<sup>1564</sup>

[AutoAddContentFolderFromLocalNodeToFolder\(FolderPath As String, Foldername As String\)](#)<sup>1564</sup>

[AutoAddContentFolderFromLocalNodeToTreeltem\(FolderPath As String, treeltemId As Integer\)](#)<sup>1565</sup>

[AutoRemoveMediaById\(dmxFolderId As Integer, dmxId As Integer\)](#)<sup>1565</sup>

[AutoRemoveMeshById\(dmxFolderId As Integer, dmxId As Integer\)](#)<sup>1565</sup>

[AutoRemoveContentByName\(ProjectPath As String, allEquallyNamed As Boolean\)](#)<sup>1565</sup>

[AutoRemoveTreeltem\(treeltemId As Integer\)](#)<sup>1565</sup>

[AutoRemoveAllResources\(removeFolder As Boolean\)](#)<sup>1566</sup>

[AutoSpreadAll \(\)](#)<sup>1566</sup>

[AutoSpreadMediaById\(dmxFolderId As Integer, dmxId As Integer\)](#)<sup>1566</sup>

[AutoSpreadMeshById\(dmxFolderId As Integer, dmxId As Integer\)](#)<sup>1566</sup>

[AutoReloadMediaById\(dmxFolderId As Integer, dmxId As Integer\)](#)<sup>1566</sup>

[AutoReloadMeshById\(dmxFolderId As Integer, dmxId As Integer\)](#)<sup>1566</sup>

[AutoReloadResource\(ProjectPath As String\)](#)<sup>1567</sup>

[AutoSpreadResource\(ProjectPath As String\)](#)<sup>1567</sup>

[AutoReloadAndSpreadResourceByPath\(ProjectPath As String\)](#)<sup>1567</sup>

[AutoReloadAndSpreadResourceByItemIndex\(treeltemId As Integer\)](#)<sup>1567</sup>

[AutoReloadAndSpreadResourceByDmxId\(dmxFolderId As Integer, dmxId As Integer\)](#)<sup>1567</sup>

[AutoRemoveInconsistent \(\)](#)<sup>1567</sup>

[AutoStoreActive\(seqNum As Integer\)](#)<sup>1568</sup>

[AutoStoreActiveToTime\(seqNum As Integer, hours As Integer, minutes As Integer, seconds As Integer, frames As Integer\)](#)<sup>1568</sup>

[AutoSetMediaFrameBlendingById\(dmxFolderId As Integer, dmxId As Integer, frameBlended As Boolean\)](#)<sup>1568</sup>

[AutoSetMediaDeinterlacingById\(dmxFolderId As Integer, dmxId As Integer, deinterlacer As Integer\)](#)<sup>1568</sup>

[AutoSetMediaAnisotropicFilteringById\(dmxFolderId As Integer, dmxId As Integer, useFiltering As Boolean\)](#)<sup>1568</sup>

[AutoSetMediaUnderscanById\(dmxFolderId As Integer, dmxId As Integer, useUnderscan As Boolean\)](#)<sup>1569</sup>

[AutoSetMediaMpegColourSpaceById\(dmxFolderId As Integer, dmxId As Integer, useMpegColourSpace As Boolean\)](#)<sup>1569</sup>

[AutoSetMediaAlphaChannelById\(dmxFolderId As Integer, dmxId As Integer, useAlphaChannel As Boolean\)](#)<sup>1569</sup>

[AutoCreateTextInput\(dmxFolderId As Integer, dmxId As Integer, Text As String\)](#)<sup>1569</sup>

[AutoSetText\(dmxFolderId As Integer, dmxId As Integer, Text As String\)](#)<sup>1569</sup>

[AutoLoadProject\(Path As String, Name As String, saveExisting As Boolean\)](#)<sup>1570</sup>

[AutoCloseProject\(save As Boolean\)](#)<sup>1570</sup>

[AutoClearSelection\(\)](#)<sup>1570</sup>

[AutoSetDeviceAcceptDmxById\(siteNum As Integer, deviceNum As Integer, acceptDmx As Boolean\)](#)<sup>1570</sup>

[AutoSetSiteAcceptDmxById\(siteNum As Integer, acceptDmx As Boolean\)](#)<sup>1570</sup>

[AutoSetDeviceDmxAddressById\(siteNum As Integer, deviceNum As Integer, index As Integer, id1 As Integer, id2 As Integer\)](#)<sup>1571</sup>

[AutoSetSequenceCuePlayMode\(seqNum As Integer, cueld As Integer, playMode As Param.CuePlayMode\)](#)<sup>1571</sup>

[AutoSetNextSequenceCuePlayMode\(seqNum As Integer, playMode As Integer\)](#)<sup>1571</sup>

[AutoSetIgnoreNextSequenceCue\(seqNum As Integer, dolgnore As Boolean\)](#)<sup>1571</sup>

[AutoChangeFullscreenStateById\(siteNum As Integer, enterFullscreen As Boolean\)](#)<sup>1572</sup>

[AutoChangeFullscreenStateByIp\(ip As String, enterFullscreen As Boolean\)](#)<sup>1572</sup>

[AutoSetTextTextureSize\(dmxFolderId As Integer, dmxId As Integer, width As Integer, height As Integer\)](#)<sup>1572</sup>

[AutoSetTextProperties\(dmxFolderId As Integer, dmxId As Integer, Font As String, size As Integer, style As Integer, alignment As Integer, colorRed As Integer, colorGreen As Integer, colorBlue As Integer\)](#)<sup>1572</sup>

[AutoSetTextCenterOnTexture\(dmxFolderId As Integer, dmxId As Integer, centerOnTexture As Boolean\)](#)<sup>1573</sup>

[AutoCreateTextInputWide\(dmxFolderId As Integer, dmxId As Integer, Text As String\)](#)<sup>1573</sup>

[AutoSetTextWide\(dmxFolderId As Integer, dmxId As Integer, Text As String\)](#)<sup>1573</sup>

[AutoSetSiteIpById\(siteNum As Integer, Ip As String\)](#)<sup>1573</sup>

[AutoIsLayerReallySelected\(siteNum As Integer, deviceNum As Integer\)](#)<sup>1573</sup>

[AutoGetNumMediaInProject \(\)](#)<sup>1574</sup>

[AutoGetNumTreeItemsInProject \(\)](#)<sup>1574</sup>

[AutoGetMediaInfo1\(index As Integer, MediaInfo As MediaType1\)](#)<sup>1574</sup>

[AutoGetMediaInfoFromTreeltem\(treeltemIndex As Integer, MediaInfo As MediaType\)](#)<sup>1574</sup>

[AutoGetTreeltemInfo\(index As Integer, ItemInfo As TreeltemType\)](#)<sup>1574</sup>

[AutoGetSequenceTransportMode\(seqNum As Integer\)](#)<sup>1574</sup>

[AutoGetSequenceTime\(seqNum As Integer, Time As TimeType\)](#)<sup>1575</sup>

[AutoGetClipRemainingTime\(siteNum As Integer, deviceNum As Integer, seqNum As Integer, Time As TimeType\)](#)<sup>1575</sup>

[AutoGetRemainingTimeUntilNextCue\(seqNum As Integer, Time As TimeType\)](#)<sup>1575</sup>

[AutoGetNumSelectedLayers \(\)](#)<sup>1575</sup>

[AutoGetSelectedLayer\(layerIndex As Integer, layerInfo As LayerType\)](#)<sup>1575</sup>

[AutoAddFolderToProject\(Name As String\)](#)<sup>1575</sup>

[AutoAddFolderToProjectPath\(Name As String, FolderRoot As String\)](#)<sup>1576</sup>

[AutoAddFolderToTreeltem\(Name As String, treeltemId As Integer\)](#)<sup>1576</sup>

[AutoRemoveFolderFromProject\(FolderPath As String\)](#)<sup>1576</sup>

[AutoSetDeviceSelection\(siteNum As Integer, deviceNum As Integer, selectionMode As Integer\)](#)<sup>1576</sup>

[AutoSetClxControllerFaderMapping\(faderId As Integer, seqNum As Integer\)](#)<sup>1576</sup>

[AutoSetClxControllerCueMapping\(cueBtnId As Integer, seqNum As Integer, cued As Integer\)](#)<sup>1577</sup>

[AutoAddCue\(seqNum As Integer, cued As Integer, hours As Integer, minutes As Integer, seconds As Integer, frames As Integer, Name As String, cueKindId As Param.CuePlayMode\)](#)<sup>1577</sup>

[AutoRemoveCueById\(seqNum As Integer, cued As Integer\)](#)<sup>1577</sup>

[AutoRemoveAllCues\(seqNum As Integer\)](#)<sup>1577</sup>

[AutoAddGraphicLayer\(siteld As Integer\)](#)<sup>1577</sup>

[AutoAddVideoLayer\(siteld As Integer\)](#)<sup>1578</sup>

[AutoRemoveGraphicLayer\(siteld As Integer, layerId As Integer\)](#)<sup>1578</sup>

[AutoRemoveVideoLayer\(siteld As Integer, layerId As Integer\)](#)<sup>1578</sup>

[AutoBackupMode\(enable As Boolean\)](#)<sup>1578</sup>

[AutoApplyView\(viewNum As Integer\)](#)<sup>1578</sup>

[AutoSetSpareFromSpread\(siteld As Integer, spareFromSpread As Boolean\)](#)<sup>1578</sup>

[AutoGetParamMedia1\(siteNum As Integer, deviceNum As Integer, ParamName As String, Info As ParamResourceType1\)](#)<sup>1579</sup>

[AutoGetParamObject1\(siteNum As Integer, deviceNum As Integer, ParamName As String, Info As ParamResourceType1\)](#)<sup>1579</sup>



[AutoGetMediaTransportMode\(siteNum As Integer, deviceNum As Integer, TransportMode As Param.TransportMode\)](#)<sup>1579</sup>

[AutoIsSiteConnected \(siteNum As Integer\)](#)<sup>1579</sup>

[AutoMoveLayerUp\(siteNum As Integer, deviceNum As Integer\)](#)<sup>1579</sup>

[AutoMoveLayerDown\(siteNum As Integer, deviceNum As Integer\)](#)<sup>1580</sup>

[AutoMoveLayerToFirstPosition\(siteNum As Integer, deviceNum As Integer\)](#)<sup>1580</sup>

[AutoMoveLayerToLastPosition\(siteNum As Integer, deviceNum As Integer\)](#)<sup>1580</sup>

[AutoSetEnableClxJogShuttle\(enable As Boolean\)](#)<sup>1580</sup>

[AutoGetEnableClxJogShuttle\(\)](#)<sup>1580</sup>

[AutoSetEnableClxFaderExt\(enable As Boolean\)](#)<sup>1580</sup>

[AutoGetEnableClxFaderExt\(\)](#)<sup>1581</sup>

[AutoSetSequenceCueWaitTime\(seqNum As Integer, cued As Integer, hours As Integer, minutes As Integer, seconds As Integer, frames As Integer\)](#)<sup>1581</sup>

[AutoSetSequenceCueJumpTargetTime\(seqNum As Integer, cued As Integer, hours As Integer, minutes As Integer, seconds As Integer, frames As Integer\)](#)<sup>1581</sup>

[AutoSetSequenceCueJumpCount\(seqNum As Integer, cued As Integer, jumpCount As Integer\)](#)<sup>1581</sup>

[AutoResetSequenceCueTriggerCount\(seqNum As Integer, cued As Integer\)](#)<sup>1581</sup>

[AutoGetContentsConsistent\(dmxFolderId As Integer, dmxId As Integer\)](#)<sup>1582</sup>

[AutoGetContentsConsistentByName\(ProjectPath As String\)](#)<sup>1582</sup>

[AutoCreateSequence \(\)](#)<sup>1582</sup>

[AutoRemoveSequence \(seqNum As Integer\)](#)<sup>1582</sup>

[AutoSetNodeOfSitelAudioClockMaster\(siteNum As Integer, isMaster As Boolean\)](#)<sup>1583</sup>

[AutoGetThumbnailByPath\(ProjectPath As String, Width As Integer, Height As Integer, Data As Object\)](#)<sup>1583</sup>

[AutoGetThumbnailByItemIndex\(treeltemIndex As Integer, Width As Integer, Height As Integer, Data As Object\)](#)<sup>1583</sup>

[AutoAddEncryptionKey\(Key As String\)](#)<sup>1583</sup>

[AutoAddEncryptionPolicy\(Policy As String\)](#)<sup>1583</sup>

### ▼ **AutoInitialize(IpStr As String, domain As Integer**

Initializes the connection to a Pandoras Box Master System using UDP

---

IpStr: IP Address of the machine running PB-Master  
domain: Domain ID

True: No error occurred False: Error occurred

#### ▼ **AutoInitializeTCP(IpStr As String, domain As Integer, waitForConnection As Boolean)**

Initializes the connection to a Pandoras Box Master System using TCP

IpStr: IP Address of the machine running PB-Master  
domain: Domain ID

waitForConnection: True: start a background thread to wait for a new connection False: only try once to connect

Success. When false is returned check AutoGetLastError()

#### ▼ **AutoUnInitialize ()**

Close any open connections

Success. When false is returned check AutoGetLastError()

#### ▼ **AutoWaitForConnection ()**

Starts a thread that keeps trying to connect to the PB-Master

Success. When false is returned check AutoGetLastError()

#### ▼ **AutoStopWaitingForConnection ()**

Stops the thread that keeps trying to connect to the PB-Master

Success. When false is returned check AutoGetLastError()

#### ▼ **AutoGetIsConnected ()**

Gets the current connection state

Success. When false is returned check AutoGetLastError()

---

▼ **AutoGetLastError ()**

Gets the code for the last error that occurred

Error code

▼ **AutoSetParamDouble(siteNum As Integer, deviceNum As Integer, ParamName As String, value As Double)**

Set a parameter to a specific value

siteNum: Site ID

deviceNum: Device ID

ParamName: Name for the parameter. (see Class Param or this [parameter list](#)<sup>1254</sup>)

value: The value will be interpreted

Success. When false is returned check AutoGetLastError()

▼ **AutoSetParamDoubleExtended(siteNum As Integer, deviceNum As Integer, ParamName As String, value As Double, silent As Boolean, direct As Boolean)**

Set a parameter to a specific value

siteNum: Site ID

deviceNum: Device ID

ParamName: Name for the parameter. (see Class Param or this [parameter list](#)<sup>1254</sup>)

value: Value

silent: Do not mark parameter active

direct: Do not use transition smoothing

Success. When false is returned check AutoGetLastError()

▼ **AutoSetParamInSelectionDouble(ParamName As String, value As Double)**

Sets the given parameter to given value for all layers in the current selection

ParamName: Name for the parameter. (see Class Param or this [parameter list](#)<sup>1254</sup>)

value: The value will be interpreted

Success. When false is returned check AutoGetLastError()

▼ **AutoGetParam (siteNum As Integer, deviceNum As Integer, ParamName As String)**

Gets the value of the parameter for given site/device

siteNum: Site ID

deviceNum: Device ID

ParamName: Name for the parameter. (see Class Param or this [parameter list](#)<sup>1254</sup>)

Success. When false is returned check `AutoGetLastError()`

▼ **AutoSetContentAtTime (siteNum As Integer, deviceNum As Integer, seqNum As Integer, hours As Integer, minutes As Integer, seconds As Integer, frames As Integer, dmxFolderId As Integer, dmxId As Integer)**

Sets the media for the container found at the given Site/Device/Sequence/Time combination. Note: This function will neither create new containers nor will it add keys. It only works with existing containers.

siteNum: Target Site ID  
 deviceNum: Target Device ID  
 seqNum: Sequence ID  
 hours: Time (Hours)  
 minutes: Time (Minutes)  
 seconds: Time (Seconds)  
 frames: Time (Frames)  
 dmxFolderId: Media Folder ID  
 dmxId: Media ID

Returns true if the PB-Master received the command

▼ **AutoAssignMesh(siteNum As Integer, deviceNum As Integer, dmxFolderId As Integer, dmxId As Integer)**

Assign a Mesh to given site/device identified by DmxFolder and DmxId

siteNum: Site ID  
 deviceNum: Device ID  
 dmxFolderId: DmxID (Folder)  
 dmxId: DmxID (Item)

Success. When false is returned check `AutoGetLastError()`

▼ **AutoAssignMeshByName(siteNum As Integer, deviceNum As Integer, MeshName As String, ParamName As String)**

Assign a Mesh to given site/device identified by name. Also allows to assign eeshes to effects etc. using ParamName

siteNum: Site ID  
 deviceNum: Device ID  
 MeshName: Mesh Name  
 ParamName: The parameter to assign the mesh to. Use "Mesh" to assign to the device itself. (see Class Param or this [parameter list](#)<sup>1254</sup>)

Success. When false is returned check `AutoGetLastError()`

▼ **AutoAssignMeshToSelection(dmxFolderId As Integer, dmxId As Integer)**

Assign a Mesh to selected devices

dmxFolderId: DmxID (Folder)  
dmxId: DmxID (Item)

Success. When false is returned check AutoGetLastError()

▼ **AutoAssignMedia(siteNum As Integer, deviceNum As Integer, dmxFolderId As Integer, dmxId As Integer)**

Assign Media to given site/device identified by DmxFolder and DmxId

siteNum: Site ID  
deviceNum: Device ID  
dmxFolderId: DmxID (Folder)  
dmxId: DmxID (Item)

Success. When false is returned check AutoGetLastError()

▼ **AutoAssignMediaByName(siteNum As Integer, deviceNum As Integer, MediaName As String, ParamName As String)**

Assign Media to given site/device identified by name

siteNum: Site ID  
deviceNum: Device ID  
MediaName: Media Name  
ParamName: Name for the parameter. (see Class Param or this [parameter list](#)<sup>1254</sup>)

Success. When false is returned check AutoGetLastError()

▼ **AutoAssignMediaToSelection(dmxFolderId As Integer, dmxId As Integer)**

Assign Media to selected devices

dmxFolderId: DmxID (Folder)  
dmxId: DmxID (Item)

Success. When false is returned check AutoGetLastError()

▼ **AutoMoveContentToFolder(ContentName As String, FolderName As String)**

Moves content identified by name to given folder

ContentName: The path+name of the content in the projects tab. ex.: Myfolder/mySubfolder/somecontent.mpg  
FolderName: Path to move to. ex.: SomeFolder/MyTargetFolder

Success. When false is returned check AutoGetLastError()

▼ **AutoMoveTreeItem(itemIdFrom As Integer, itemIdTo As Integer)**

Move tree item to another tree item

itemIdFrom: tree item source  
itemIdTo: tree item target

Success. When false is returned check `AutoGetLastError()`

#### ▼ **AutoSetSequenceTransportMode(sequenceNum As Integer, ModeName As String)**

Sets the transport mode for sequence with given ID

sequenceNum: Sequence ID  
ModeName: Transport mode, case sensitive (Play/Pause/Stop)

Success. When false is returned check `AutoGetLastError()`

#### ▼ **AutoMoveSequenceToCue(sequenceNum As Integer, cueId As Integer)**

Moves the nowpointer to the position of the cue with given ID

sequenceNum: Sequence ID  
cueId: Cue ID

Success. When false is returned check `AutoGetLastError()`

#### ▼ **AutoMoveSequenceToTime(sequenceNum As Integer, hours As Integer, minutes As Integer, seconds As Integer, frames As Integer)**

Moves the nowpointer to given time

sequenceNum: Sequence ID  
hours: Time (Hours)  
minutes: Time (Minutes)  
seconds: Time (Seconds)  
frames: Time (Frames)

Success. When false is returned check `AutoGetLastError()`

#### ▼ **AutoMoveSequenceToLastNextFrame(sequenceNum As Integer, isNext As Boolean)**

Moves to either the next/previous frame

sequenceNum: Sequence ID  
isNext: true: next frame | false: previous frame

Success. When false is returned check `AutoGetLastError()`

#### ▼ **AutoMoveSequenceToLastNextCue(sequenceNum As Integer, isNext As Boolean)**

Moves to either the next/previous cue

sequenceNum: Sequence ID  
isNext: true: next cue | false: previous cue

Success. When false is returned check AutoGetLastError()

#### ▼ **AutoSetSequenceTransparency(seqNum As Integer, transparency As Integer)**

Sets the transparency for given sequence

seqNum: Sequence ID  
transparency: Opacity between 0 and 255

Success. When false is returned check AutoGetLastError()

#### ▼ **AutoGetSequenceTransparency (seqNum As Integer)**

Get the transparency of given sequence

seqNum: Sequence ID

Sequence Transparency (0-255)

#### ▼ **AutoSetSequenceTimeCodeMode(seqNum As Integer, timeCodeMode As Param.SequenceTimeCodeMode)**

Enables or disables a sequence to send/receive timecode

seqNum: Sequence ID  
timeCodeMode: The timecode mode to use

Success. When false is returned check AutoGetLastError()

#### ▼ **AutoSetSequenceTimeCodeOffset(seqNum As Integer, hours As Integer, minutes As Integer, seconds As Integer, frames As Integer)**

Set the offset that will be added to the Pandoras Box Timecode. Negative values possible.

seqNum: Sequence ID  
hours: Time (Hours)  
minutes: Time (Minutes)  
seconds: Time (Seconds)  
frames: Time (Frames)

Success. When false is returned check AutoGetLastError()

#### ▼ **AutoSetSequenceTimeCodeStopAction(seqNum As Integer, stopAction As Param.SequenceTimeCodeStopAction)**

Set the behavior on timecode signal stop

---

seqNum: Sequence ID  
stopAction: stop,pause or continue playback

Success. When false is returned check AutoGetLastError()

#### ▼ **AutoResetAll ()**

Reset all active values

Success. When false is returned check AutoGetLastError()

#### ▼ **AutoResetSite(siteNum As Integer)**

Reset all active values for given site

siteNum: Site ID

Success. When false is returned check AutoGetLastError()

#### ▼ **AutoResetDevice(siteNum As Integer, deviceNum As Integer)**

Reset all active values for given device

siteNum: Site ID

deviceNum: Device ID

Success. When false is returned check AutoGetLastError()

#### ▼ **AutoResetParam(siteNum As Integer, deviceNum As Integer, ParamName As String)**

Remove active value of specific parameter

siteNum: Site ID

deviceNum: Device ID

ParamName: Name for the parameter. (see Class Param or this [parameter list](#)<sup>1254</sup>)

Success. When false is returned check AutoGetLastError()

#### ▼ **AutoActivateAll ()**

Select all parameters as active

Success. When false is returned check AutoGetLastError()



---

▼ **AutoActivateSite(siteNum As Integer)**

Set all parameters of all devices of a whole site as active

siteNum: Site ID

Success. When false is returned check AutoGetLastError()

▼ **AutoActivateDevice(siteNum As Integer, deviceNum As Integer)**

Set all parameters of a specific device as active

siteNum: Site ID

deviceNum: Device ID

Success. When false is returned check AutoGetLastError()

▼ **AutoActivateParam(siteNum As Integer, deviceNum As Integer, ParamName As String)**

Set a specific parameter as active

siteNum: Site ID

deviceNum: Device ID

ParamName: Name for the parameter. (see Class Param or this [parameter list](#)<sup>1254</sup>)

Success. When false is returned check AutoGetLastError()

▼ **AutoClearAllActive ()**

Set all active values as inactive. The values themselves are preserved.

Success. When false is returned check AutoGetLastError()

▼ **AutoClearActiveSite(siteNum As Integer)**

Set all active values of a site as inactive. The values themselves are preserved.

siteNum: Site ID

Success. When false is returned check AutoGetLastError()

▼ **AutoClearActiveDevice(siteNum As Integer, deviceNum As Integer)**

Set all active values of a specific device as inactive. The values themselves are preserved.

siteNum: Site ID

deviceNum: Device ID

Success. When false is returned check AutoGetLastError()

#### ▼ **AutoClearActiveParam(siteNum As Integer, deviceNum As Integer, ParamName As String)**

Set a parameter value inactive. The values themselves are preserved.

siteNum: Site ID

deviceNum: Device ID

ParamName: Name for the parameter. (see Class Param or this [parameter list](#)<sup>1254</sup>)

Success. When false is returned check AutoGetLastError()

#### ▼ **AutoToggleFullscreen(siteNum As Integer)**

Toggles full screen mode of a site

siteNum: Site ID

Success. When false is returned check AutoGetLastError()

#### ▼ **AutoSetParamRelativeDouble(siteNum As Integer, deviceNum As Integer, ParamName As String, value As Double)**

Add or subtract a value from a parameter

siteNum: Site ID

deviceNum: Device ID

ParamName: Name for the parameter. (see Class Param or this [parameter list](#)<sup>1254</sup>)

value: Value to add, can be negative

Success. When false is returned check AutoGetLastError()

#### ▼ **AutoSetParamRelativeDoubleExtended(siteNum As Integer, deviceNum As Integer, ParamName As String, value As Double, silent As Boolean, direct As Boolean)**

Add or subtract a value from a parameter

siteNum: Site ID

deviceNum: Device ID

ParamName: Name for the parameter. (see Class Param or this [parameter list](#)<sup>1254</sup>)

value: Value to add, can be negative

silent: Do not mark parameter active

direct: Do not use transition smoothing

Success. When false is returned check AutoGetLastError()

---

▼ **AutoSetParamRelativeInSelectionDouble (ParamName As String, value As Double)**

Add or subtract a value from a parameter in the current selection

ParamName: Name for the parameter. (see Class Param or this [parameter list](#)<sup>1254</sup>)  
value: Value to add, can be negative

Success. When false is returned check AutoGetLastError()

▼ **AutoAddContent(FullPath As String, siteNum As Integer, dmxFolderId As Integer, dmxId As Integer)**

Add content from given path and assign DmxIDs

FullPath: Absolute system path to media to add (ex. c:/coolux/content/...)  
siteNum: Site ID  
dmxFolderId: DmxID (Folder)  
dmxId: DmxID (Item)

Success. When false is returned check AutoGetLastError()

▼ **AutoAddContentToFolder(FullPath As String, siteNum As Integer, dmxFolderId As Integer, dmxId As Integer, Foldername As String)**

Adds content from given folder to a specific folder, also assigning DmxIDs

FullPath: Absolute system path to media to add (ex. c:/coolux/content/...)  
siteNum: Site ID  
dmxFolderId: DmxID (Folder)  
dmxId: DmxID (Item)  
Foldername: Target folder to add content to

Success. When false is returned check AutoGetLastError()

▼ **AutoAddContentToTreeItem(FullPath As String, siteNum As Integer, dmxFolderId As Integer, dmxId As Integer, treeItemId As Integer)**

Add content to a tree item

FullPath: Absolute system path to media to add (ex. c:/coolux/content/...)  
siteNum: Site ID  
dmxFolderId: DmxID (Folder)  
dmxId: DmxID (Item)  
treeItemId: Target tree item

Success. When false is returned check AutoGetLastError()

▼ **AutoAddContentFromLocalNode (FullPath As String)**

Add content from local node using an absolute path

FullPath: Absolute system path to media to add (ex. c:/coolux/content/...)

Success. When false is returned check AutoGetLastError()

#### ▼ **AutoAddContentFromLocalNodeToFolder(FullPath As String, Foldername As String)**

FullPath: Absolute system path to media to add (ex. c:/coolux/content/...)

Foldername: Target path in PB project

Success. When false is returned check AutoGetLastError()

#### ▼ **AutoAddContentFromLocalNodeToTreeltem(FullPath As String, treeltemId As Integer)**

Add content from an absolute system path to a specific tree node

FullPath: Absolute system path to media to add (ex. c:/coolux/content/...)

treeltemId: target tree item

Success. When false is returned check AutoGetLastError()

#### ▼ **AutoAddContentFolder(FolderPath As String, siteNum As Integer, dmxFolderId As Integer, dmxId As Integer, ProjectPath As String)**

Add a complete folder with content to the project

FolderPath: Path to content

siteNum: Site ID

dmxFolderId: DmxID (Folder)

dmxId: DmxID (Item)

ProjectPath: Project path

Success. When false is returned check AutoGetLastError()

#### ▼ **AutoAddContentFolderFromLocalNode(FolderPath As String)**

Add a complete folder with content to the project

FolderPath: Folder to add

Success. When false is returned check AutoGetLastError()

#### ▼ **AutoAddContentFolderFromLocalNodeToFolder(FolderPath As String, Foldername As String)**

Add a complete folder with content to the project at a specific folder

FolderPath: Folder to add  
Foldename: Target folder in project tree

Success. When false is returned check AutoGetLastError()

#### ▼ **AutoAddContentFolderFromLocalNodeToTreeltem(FolderPath As String, treeltemId As Integer)**

Add a complete folder with content to the project to a specific Treeltem

FolderPath: Folder to add  
treeltemId: tree item to add to

Success. When false is returned check AutoGetLastError()

#### ▼ **AutoRemoveMediaByld(dmxFolderId As Integer, dmxDId As Integer)**

Removes Media with given DmxID

dmxFolderId: DmxID (Folder)  
dmxDId: DmxID (Item)

Success. When false is returned check AutoGetLastError()

#### ▼ **AutoRemoveMeshByld(dmxFolderId As Integer, dmxDId As Integer)**

Removes Mesh with given DmxID

dmxFolderId: DmxID (Folder)  
dmxDId: DmxID (Item)

Success. When false is returned check AutoGetLastError()

#### ▼ **AutoRemoveContentByName(ProjectPath As String, allEquallyNamed As Boolean)**

Removes content by project path

ProjectPath: Path to the project content  
allEquallyNamed: True: Removes all contents with the same name| False: Remove only one (the first) content with that name

Success. When false is returned check AutoGetLastError()

#### ▼ **AutoRemoveTreeltem(treeltemId As Integer)**

Remove a tree item

treeltemId: tree item to remove

Success. When false is returned check AutoGetLastError()

---

▼ **AutoRemoveAllResources(removeFolder As Boolean)**

Remove all resources in specific folder

removeFolder: True: Removes everything | False: Remove files only. Folder structure stays intact

Success. When false is returned check AutoGetLastError()

▼ **AutoSpreadAll ()**

Trigger a "Spread All Resources"

Success. When false is returned check AutoGetLastError()

▼ **AutoSpreadMediaByld(dmxFolderId As Integer, dmxId As Integer)**

Trigger spread for media identified by DmxID

dmxFolderId: DmxID (Folder)

dmxId: DmxID (Item)

Success. When false is returned check AutoGetLastError()

▼ **AutoSpreadMeshByld(dmxFolderId As Integer, dmxId As Integer)**

Trigger spread for mesh identified by DmxID

dmxFolderId: DmxID (Folder)

dmxId: DmxID (Item)

Success. When false is returned check AutoGetLastError()

▼ **AutoReloadMediaByld(dmxFolderId As Integer, dmxId As Integer)**

Trigger reload for media with given DmxID

dmxFolderId: DmxID (Folder)

dmxId: DmxID (Item)

Success. When false is returned check AutoGetLastError()

▼ **AutoReloadMeshByld(dmxFolderId As Integer, dmxId As Integer)**

Trigger reload for mesh with given DmxID

dmxFolderId: DmxID (Folder)

dmxId: DmxID (Item)

Success. When false is returned check AutoGetLastError()

---

▼ **AutoReloadResource(ProjectPath As String)**

Trigger reload for resource with given name

ProjectPath: project path

Success. When false is returned check AutoGetLastError()

▼ **AutoSpreadResource(ProjectPath As String)**

Trigger spread for resource with given name

ProjectPath: project path

Success. When false is returned check AutoGetLastError()

▼ **AutoReloadAndSpreadResourceByPath(ProjectPath As String)**

Trigger reload and spread for resource identified by path name

ProjectPath: project path

Success. When false is returned check AutoGetLastError()

▼ **AutoReloadAndSpreadResourceByItemIndex(treeItemId As Integer)**

Trigger reload and spread for resource identified by tree item index

treeItemId: tree item id of resource

Success. When false is returned check AutoGetLastError()

▼ **AutoReloadAndSpreadResourceByDmxId(dmxFolderId As Integer, dmxId As Integer)**

Trigger reload and spread for resource identified by DmxID

dmxFolderId: DmxID (Folder)

dmxId: DmxID (Item)

Success. When false is returned check AutoGetLastError()

▼ **AutoRemoveInconsistent ()**

Remove all inconsistent files

Success. When false is returned check AutoGetLastError()

---

▼ **AutoStoreActive(seqNum As Integer)**

Stores active values in given sequence at the current timecode

seqNum: Sequence ID

Success. When false is returned check AutoGetLastError()

▼ **AutoStoreActiveToTime(seqNum As Integer, hours As Integer, minutes As Integer, seconds As Integer, frames As Integer)**

Stores active values in given sequence at given time

seqNum: Sequence ID

hours: Time (Hours)

minutes: Time (Minutes)

seconds: Time (Seconds)

frames: Time (Frames)

Success. When false is returned check AutoGetLastError()

▼ **AutoSetMediaFrameBlendingByld(dmxFolderId As Integer, dmxId As Integer, frameBlended As Boolean)**

Sets the Frame Blending for media identified by given DmxID

dmxFolderId: DmxID (Folder)

dmxId: DmxID (Item)

frameBlended: Use fra

Success. When false is returned check AutoGetLastError()

▼ **AutoSetMediaDeinterlacingByld(dmxFolderId As Integer, dmxId As Integer, deinterlacer As Integer)**

Sets the Deinterlacing for media identified by given DmxID

dmxFolderId: DmxID (Folder)

dmxId: DmxID (Item)

deinterlacer: Use deinterlacing?

Success. When false is returned check AutoGetLastError()

▼ **AutoSetMediaAnisotropicFilteringByld(dmxFolderId As Integer, dmxId As Integer, useFiltering As Boolean)**

Sets the Anisostropic Filtering for media identified by given DmxID

dmxFolderId: DmxID (Folder)

dmxId: DmxID (Item)

useFiltering: Use Anisostrophicfiltering?



---

Success. When false is returned check `AutoGetLastError()`

▼ **AutoSetMediaUnderscanById(dmxFolderId As Integer, dmxDId As Integer, useUnderscan As Boolean)**

Sets the Underscan for media identified by given DmxID

dmxFolderId: DmxID (Folder)  
dmxDId: DmxID (Item)  
useUnderscan: Use underscan?

Success. When false is returned check `AutoGetLastError()`

▼ **AutoSetMediaMpegColourSpaceById(dmxFolderId As Integer, dmxDId As Integer, useMpegColourSpace As Boolean)**

Sets whether to use mpeg color space conversion for media identified by given DmxID

dmxFolderId: DmxID (Folder)  
dmxDId: DmxID (Item)  
useMpegColourSpace: Use mpeg color space conversion?

Success. When false is returned check `AutoGetLastError()`

▼ **AutoSetMediaAlphaChannelById(dmxFolderId As Integer, dmxDId As Integer, useAlphaChannel As Boolean)**

Sets the Alpha Channel usage for media identified by given DmxID

dmxFolderId: DmxID (Folder)  
dmxDId: DmxID (Item)  
useAlphaChannel: Use alpha channel?

Success. When false is returned check `AutoGetLastError()`

▼ **AutoCreateTextInput(dmxFolderId As Integer, dmxDId As Integer, Text As String)**

Creates a new text asset with given DmxIDs

dmxFolderId: DmxID (Folder)  
dmxDId: DmxID (Item)  
Text: Asset text

Success. When false is returned check `AutoGetLastError()`

▼ **AutoSetText(dmxFolderId As Integer, dmxDId As Integer, Text As String)**

Sets the text for the text asset with given DmxIDs

---

dmxFolderId: DmxID (Folder)  
dmxId: DmxID (Item)  
Text: Text

Success. When false is returned check AutoGetLastError()

#### ▼ **AutoLoadProject(Path As String, Name As String, saveExisting As Boolean)**

Loads a project from given path with given filename.

Path: Folder name

Name: Project file name

saveExisting: Save the existing project before opening the new one?

Success. When false is returned check AutoGetLastError()

#### ▼ **AutoCloseProject(save As Boolean)**

Closes the current project

save: Save project before close?

Success. When false is returned check AutoGetLastError()

#### ▼ **AutoClearSelection()**

Clears the device selection

Success. When false is returned check AutoGetLastError()

#### ▼ **AutoSetDeviceAcceptDmxById(siteNum As Integer, deviceNum As Integer, acceptDmx As Boolean)**

Set whether given device should accept Dmx values

siteNum: Site ID

deviceNum: Device ID

acceptDmx: Accept Dmx?

Success. When false is returned check AutoGetLastError()

#### ▼ **AutoSetSiteAcceptDmxById(siteNum As Integer, acceptDmx As Boolean)**

Set whether given site should accept Dmx values

siteNum: Site ID

acceptDmx: Accept Dmx?

Success. When false is returned check AutoGetLastError()

▼ **AutoSetDeviceDmxAddressById(siteNum As Integer, deviceNum As Integer, index As Integer, id1 As Integer, id2 As Integer)**

Sets the Dmx address for given site/device

siteNum: Site ID  
deviceNum: Device ID  
index: Channel Id  
id1: Dmx Subnet  
id2: Dmx Universe

Success. When false is returned check AutoGetLastError()

▼ **AutoSetSequenceCuePlayMode(seqNum As Integer, cueld As Integer, playMode As Param.CuePlayMode)**

Sets the play mode for a cue at given sequence

seqNum: Sequence ID  
cueld: Cue ID  
playMode: The cue play mode

Success. When false is returned check AutoGetLastError()

▼ **AutoSetNextSequenceCuePlayMode(seqNum As Integer, playMode As Integer)**

Sets the play mode for the next cue at given sequence

seqNum: Sequence ID  
playMode: The cue play mode

Success. When false is returned check AutoGetLastError()

▼ **AutoSetIgnoreNextSequenceCue(seqNum As Integer, dolgnore As Boolean)**

Sets whether to ignore the next cue in given sequence

seqNum: Sequence ID  
dolgnore: Ignore next cue?

Success. When false is returned check AutoGetLastError()

▼ **AutoSaveProject ()**

Saves the current project

Success. When false is returned check AutoGetLastError()

▼ **AutoChangeFullscreenStateById(siteNum As Integer, enterFullscreen As Boolean)**

Change the fullscreen mode for given site identified by Id

siteNum: Site ID

enterFullscreen: Enter fullscreen?

Success. When false is returned check AutoGetLastError()

▼ **AutoChangeFullscreenStateByIp(ip As String, enterFullscreen As Boolean)**

Change the fullscreen mode for given site identified by Ip

Ip: IP Address

enterFullscreen: Enter fullscreen?

Success. When false is returned check AutoGetLastError()

▼ **AutoSetTextTextureSize(dmxFolderId As Integer, dmxDId As Integer, width As Integer, height As Integer)**

Sets the texture size for text asset identified by DmxDId

dmxFolderId: DmxDID (Folder)

dmxDId: DmxDID (Item)

width: New texture width

height: New texture height

Success. When false is returned check AutoGetLastError()

▼ **AutoSetTextProperties(dmxFolderId As Integer, dmxDId As Integer, Font As String, size As Integer, style As Integer, alignment As Integer, colorRed As Integer, colorGreen As Integer, colorBlue As Integer)**

Set the style for an existing text asset

dmxFolderId: DmxD ID (Folder)

dmxDId: DmxD ID (Item)

Font: Font name

size: size in pixels

style: text style

alignment: text alignment

colorRed: Color (Red)

colorGreen: Color (Green)

colorBlue: Color (Blue)

Success. When false is returned check AutoGetLastError()

▼ **AutoSetTextCenterOnTexture(dmxFolderId As Integer, dmxDId As Integer, centerOnTexture As Boolean)**

Set the center on texture for text asset identified by DmxDId

dmxFolderId: DmxDID (Folder)

dmxDId: DmxDID (Item)

centerOnTexture: Center text on texture?

Success. When false is returned check AutoGetLastError()

▼ **AutoCreateTextInputWide(dmxFolderId As Integer, dmxDId As Integer, Text As String)**

Creates new text asset. Adjusts width automatically.

dmxFolderId: DmxDID (Folder)

dmxDId: DmxDID (Item)

Text: Text

Success. When false is returned check AutoGetLastError()

▼ **AutoSetTextWide(dmxFolderId As Integer, dmxDId As Integer, Text As String)**

Sets the text of a text asset and adjusts width automatically

dmxFolderId: DmxDID (Folder)

dmxDId: DmxDID (Item)

Text: Text

Success. When false is returned check AutoGetLastError()

▼ **AutoSetSiteIpByld(siteNum As Integer, Ip As String)**

Changes the IP address of a site.

siteNum: Site ID

Ip: IP Address

Success. When false is returned check AutoGetLastError()

▼ **AutolsLayerReallySelected(siteNum As Integer, deviceNum As Integer)**

Check if layer is in current selection

siteNum: Site ID

deviceNum: Device ID

Is the given layer currently selected?

---

▼ **AutoGetNumMediaInProject ()**

Gets the number of media in the project

Number of media in project

▼ **AutoGetNumTreeItemsInProject ()**

Gets the number of tree items in project

Number of tree items in project

▼ **AutoGetMediaInfo1(index As Integer, MediaInfo As MediaType1)**

Gets information on media identified by index

index: Index

MediaInfo: MediaInfo1 object to write information to

Success. When false is returned check AutoGetLastError()

▼ **AutoGetMediaInfoFromTreeItem(treeltemIndex As Integer, MediaInfo As MediaType1)**

Gets information on media identified by index

treeltemindex: Index

MediaInfo: MediaInfo1 object to write information to

Success. When false is returned check AutoGetLastError()

▼ **AutoGetTreeItemInfo(index As Integer, ItemInfo As TreeItemType)**

Get information on tree item identified by index

index: Index

ItemInfo: TreeItemType object to write results to

Success. When false is returned check AutoGetLastError()

▼ **AutoGetSequenceTransportMode(seqNum As Integer)**

Get the transport mode of a sequence

seqNum: Sequence ID

Success. When false is returned check AutoGetLastError()

---

▼ **AutoGetSequenceTime(seqNum As Integer, Time As TimeType)**

Get the time of a sequence

seqNum: Sequence ID

Time: TimeType to write information to

Success. When false is returned check AutoGetLastError()

▼ **AutoGetClipRemainingTime(siteNum As Integer, deviceNum As Integer, seqNum As Integer, Time As TimeType)**

Get the remaining time for a clip on a specific layer for given sequence

siteNum: Site ID

deviceNum: Device ID

seqNum: Sequence ID

Time: TimeType to write information to

Success. When false is returned check AutoGetLastError()

▼ **AutoGetRemainingTimeUntilNextCue(seqNum As Integer, Time As TimeType)**

Get remaining time until the next cue for given sequence

seqNum: Sequence ID

Time: TimeType to write information to

Success. When false is returned check AutoGetLastError()

▼ **AutoGetNumSelectedLayers ()**

Get the number of selected layers

Number of selected layers

▼ **AutoGetSelectedLayer(layerIndex As Integer, layerInfo As LayerType)**

Get the selected layer with given number in selection.

layerIndex: Index of the layer in selection. Values between 0 and (AutoGetNumSelectedLayers - 1)

layerInfo: LayerType object to write results to

Success. When false is returned check AutoGetLastError()

▼ **AutoAddFolderToProject(Name As String)**

Create a new folder

---

Name: Name for the new folder

Success. When false is returned check AutoGetLastError()

▼ **AutoAddFolderToProjectPath(Name As String, FolderRoot As String)**

Create new folder in given path

Name: Name for the new folder

FolderRoot: Path to create folder in

Success. When false is returned check AutoGetLastError()

▼ **AutoAddFolderToTreeltem(Name As String, treeltemId As Integer)**

Create new folder in given tree item

Name: Name for the new folder

treeltemId: Tree item to create folder in

Success. When false is returned check AutoGetLastError()

▼ **AutoRemoveFolderFromProject(FolderPath As String)**

Remove a folder from the project

FolderPath: Folder with path

Success. When false is returned check AutoGetLastError()

▼ **AutoSetDeviceSelection(siteNum As Integer, deviceNum As Integer, selectionMode As Integer)**

Select / Deselect a device

siteNum: Site ID

deviceNum: Device ID

selectionMode: True: Selected| False: Not selected

Success. When false is returned check AutoGetLastError()

▼ **AutoSetClxControllerFaderMapping(faderId As Integer, seqNum As Integer)**

Map a coolux controller fader to a sequence

faderId: Fader ID

seqNum: Sequence ID

Success. When false is returned check AutoGetLastError()



---

▼ **AutoSetClixControllerCueMapping(cueBtnId As Integer, seqNum As Integer, cueld As Integer)**

Map a coolux controller button to a cue

cueBtnId: Button ID  
seqNum: Sequence ID  
cueld: Cue ID

Success. When false is returned check AutoGetLastError()

▼ **AutoAddCue(seqNum As Integer, cueld As Integer, hours As Integer, minutes As Integer, seconds As Integer, frames As Integer, Name As String, cueKindId As Param.CuePlayMode)**

Add cue to given sequence at given time

seqNum: Sequence ID  
cueld: Cue ID  
hours: Time (Hours)  
minutes: Time (Minutes)  
seconds: Time (Seconds)  
frames: Time (Frames)  
Name: Cue name  
cueKindId: Kind of cue

Success. When false is returned check AutoGetLastError()

▼ **AutoRemoveCueById(seqNum As Integer, cueld As Integer)**

Remove cue with given ID on given sequence

seqNum: Sequence ID  
cueld: Cue ID

Success. When false is returned check AutoGetLastError()

▼ **AutoRemoveAllCues(seqNum As Integer)**

Remove all cues for a sequence

seqNum: Sequence ID

Success. When false is returned check AutoGetLastError()

▼ **AutoAddGraphicLayer(siteId As Integer)**

Add new graphic layer

siteId: Site ID

Success. When false is returned check AutoGetLastError()

---

▼ **AutoAddVideoLayer(siteld As Integer)**

Add new video layer

siteld: Site ID

Success. When false is returned check AutoGetLastError()

▼ **AutoRemoveGraphicLayer(siteld As Integer, layerId As Integer)**

Remove a graphic layer by id

siteld: Site ID

layerId: Layer ID

Success. When false is returned check AutoGetLastError()

▼ **AutoRemoveVideoLayer(siteld As Integer, layerId As Integer)**

Remove a video layer by id

siteld: Site ID

layerId: Layer ID

Success. When false is returned check AutoGetLastError()

▼ **AutoBackupMode(enable As Boolean)**

Enables/Disables the backup mode

enable: Enable backup mode?

Success. When false is returned check AutoGetLastError()

▼ **AutoApplyView(viewNum As Integer)**

Applies view identified by given number

viewNum: The view number

Success. When false is returned check AutoGetLastError()

▼ **AutoSetSpareFromSpread(siteld As Integer, spareFromSpread As Boolean)**

Set the spare from spread option

siteld: Site ID

spareFromSpread: True: Do not spread resources to this site | False: Spreading resources possible

Success. When false is returned check AutoGetLastError()

▼ **AutoGetParamMedia1(siteNum As Integer, deviceNum As Integer, ParamName As String, Info As ParamResourceType1)**

Get resource information of a device

siteNum: Site ID

deviceNum: Device ID

ParamName: Name for the parameter. (see Class Param or this [parameter list](#)<sup>1254</sup>)

Info: ResourceType1 object to write information to

Success. When false is returned check AutoGetLastError()

▼ **AutoGetParamObject1(siteNum As Integer, deviceNum As Integer, ParamName As String, Info As ParamResourceType1)**

Get information of a specific parameter

siteNum: Site ID

deviceNum: Device ID

ParamName: Name for the parameter. (see Class Param or this [parameter list](#)<sup>1254</sup>)

Info: ParamResourceType1 object to write information to

Success. When false is returned check AutoGetLastError()

▼ **AutoGetMediaTransportMode(siteNum As Integer, deviceNum As Integer, TransportMode As TransportMode)**

Checks whether given site is connected

siteNum: Site ID

deviceNum: Device ID

TransportMode: TransportMode object to write the result to

Success. When false is returned check AutoGetLastError()

▼ **AutolsSiteConnected (siteNum As Integer)**

Checks whether given site is connected

siteNum: Site ID

Success. When false is returned check AutoGetLastError()

▼ **AutoMoveLayerUp(siteNum As Integer, deviceNum As Integer)**

Move given layer up by one in the device tree

siteNum: Site ID

deviceNum: Device ID

Success. When false is returned check AutoGetLastError()

---

▼ **AutoMoveLayerDown(siteNum As Integer, deviceNum As Integer)**

Move given layer down by one in the device tree

siteNum: Site ID

deviceNum: Device ID

Success. When false is returned check AutoGetLastError()

▼ **AutoMoveLayerToFirstPosition(siteNum As Integer, deviceNum As Integer)**

Move given layer to the first position in the device tree

siteNum: Site ID

deviceNum: Device ID

Success. When false is returned check AutoGetLastError()

▼ **AutoMoveLayerToLastPosition(siteNum As Integer, deviceNum As Integer)**

Move given layer to the last position in the device tree

siteNum: Site ID

deviceNum: Device ID

Success. When false is returned check AutoGetLastError()

▼ **AutoSetEnableCixJogShuttle(enable As Boolean)**

Enable/Disable the JogShuttle

enable: Enable?

Success. When false is returned check AutoGetLastError()

▼ **AutoGetEnableCixJogShuttle()**

Get whether the JogShuttle is enabled

JogShuttle enabled?

▼ **AutoSetEnableCixFaderExt(enable As Boolean)**

Enable/Disable the FaderExtention

enable: Enable?

Success. When false is returned check AutoGetLastError()

---

▼ **AutoGetEnableCixFaderExt()**

Gets whether the FaderExtension is enabled

FaderExtension enabled?

▼ **AutoSetSequenceCueWaitTime(seqNum As Integer, cueld As Integer, hours As Integer, minutes As Integer, seconds As Integer, frames As Integer)**

Set the wait time for given cue

seqNum: Sequence ID  
cueld: Cue ID  
hours: Time (Hours)  
minutes: Time (Minutes)  
seconds: Time (Seconds)  
frames: Time (Frames)

Success. When false is returned check AutoGetLastError()

▼ **AutoSetSequenceCueJumpTargetTime(seqNum As Integer, cueld As Integer, hours As Integer, minutes As Integer, seconds As Integer, frames As Integer)**

Set the jump target for given cue

seqNum: Sequence ID  
cueld: Cue ID  
hours: Time (Hours)  
minutes: Time (Minutes)  
seconds: Time (Seconds)  
frames: Time (Frames)

Success. When false is returned check AutoGetLastError()

▼ **AutoSetSequenceCueJumpCount(seqNum As Integer, cueld As Integer, jumpCount As Integer)**

Set the jump count for given cue

seqNum: Sequence ID  
cueld: Cue ID  
jumpCount: Number of jumps

Success. When false is returned check AutoGetLastError()

▼ **AutoResetSequenceCueTriggerCount(seqNum As Integer, cueld As Integer)**

Reset the trigger count for given cue

---

seqNum: Sequence ID  
cueld: Cue ID

Success. When false is returned check AutoGetLastError()

▼ **AutoGetContentIsConsistent(dmxFolderId As Integer, dmxDId As Integer)**

Get whether given content is consistent

dmxFolderId: DmxID (Folder)  
dmxDId: DmxID (Item)

Is content consistent?

▼ **AutoGetContentIsConsistentByName(ProjectPath As String)**

Get whether content identified by name is consistent

ProjectPath: Path to project item

Is content consistent?

▼ **AutoCreateSequence ()**

Create a new sequence

Sequence ID

▼ **AutoRemoveSequence (seqNum As Integer)**

Remove sequence

seqNum: Sequence ID

Success. When false is returned check AutoGetLastError()

▼ **AutoSetShowCursorInFullscreen(siteNum As Integer, showCursor As Boolean)**

Enable/Disable cursor in fullscreen

siteNum: Site ID  
showCursor: Show cursor?

Success. When false is returned check AutoGetLastError()

---

▼ **AutoSetNodeOfSitelAudioClockMaster(siteNum As Integer, isMaster As Boolean)**

Set site as audio clock master

siteNum: Site ID

isMaster: Is site master?

Success. When false is returned check AutoGetLastError()

▼ **AutoGetThumbnailByPath(ProjectPath As String, Width As Integer, Height As Integer, Data As Object)**

Get thumbnail for given path

ProjectPath: Path to project item

Width: Integer to write width to

Height: Integer to write height to

Data: Image Data

Success. When false is returned check AutoGetLastError()

▼ **AutoGetThumbnailByItemIndex(treeltemIndex As Integer, Width As Integer, Height As Integer, Data As Object)**

Get thumbnail for given item index

treeltemIndex: Item index

Width: Integer to write width to

Height: Integer to write height to

Data: Image Data

Success. When false is returned check AutoGetLastError()

▼ **AutoAddEncryptionKey(Key As String)**

Add encryption key

Key: The encryption key

Success. When false is returned check AutoGetLastError()

▼ **AutoAddEncryptionPolicy(Policy As String)**

Add encryption policy

Policy: The encryption policy

Success. When false is returned check AutoGetLastError()

▼ **AutoSetRouteInputToLayer(ByVal siteNum As Integer</text></para>ByVal enable As Boolean</text></para>)**

Sets input routing for given layer

▼ **AutoSetRouteInputToWidgetDesigner(ByVal siteNum As Integer</text></para>ByVal enable As Boolean</text></para>)**

Sets input routing to the Widget Designer

▼ **AutoEnableOutputForPicking(ByVal siteNum As Integer</text></para>ByVal outputNum As Integer</text></para>ByVal enable As Boolean</text></para>)**

Enable/Disable Output for layer picking feature

▼ **AutoSetASIOMasterVolume(ByVal siteNum As Integer</text></para>ByVal value As Double</text></para>)**

Sets the ASIO master volume

▼ **AutoSetRouteInputToLayer(ByVal siteNum As Integer,ByVal enable As Boolean)**

Sets input routing for given layer

▼ **AutoSetRouteInputToWidgetDesigner(ByVal siteNum As Integer,ByVal enable As Boolean)**

Sets input routing to the Widget Designer

▼ **AutoEnableOutputForPicking(ByVal siteNum As Integer,ByVal outputNum As Integer,ByVal enable As Boolean)**

Enable/Disable Output for layer picking feature

▼ **AutoSetASIOMasterVolume(ByVal siteNum As Integer,ByVal value As Double)**

Sets the ASIO master volume

▼ **AutoCreatePlaylist(ByVal setDmxIds As Boolean,ByVal newDmxFolderId As Integer,ByVal newDmxId As Integer)**

Creates a new Playlist



- ▼ **AutoCreatePlaylistByPath(ByRef PlaylistFolderPath As String PlaylistFolderPath,ByVal setDmxIds As Boolean,ByVal newDmxFolderId As Integer,ByVal newDmxId As Integer)**

Creates a new Playlist in given path

- ▼ **AutoCreatePlaylistByItemId(ByVal playlistFolderItemId As Integer,ByVal setDmxIds As Boolean,ByVal newDmxFolderId As Integer,ByVal newDmxId As Integer)**

Creates a new Playlist by given item id

- ▼ **AutoCreatePlaylistFromFolderByPath(ByRef PlaylistFolderPath As String PlaylistFolderPath,ByRef ResourceFolderPath As String ResourceFolderPath,ByVal setDmxIds As Boolean,ByVal newDmxFolderId As Integer,ByVal newDmxId As Integer)**

Creates a new playlist from files in given folder

- ▼ **AutoCreatePlaylistFromFolderByItemId(ByVal playlistFolderItemId As Integer,ByVal resourceFolderItemId As Integer,ByVal setDmxIds As Boolean,ByVal newDmxFolderId As Integer,ByVal newDmxId As Integer)**

Creates a new playlist from files in given folder

- ▼ **AutoPushBackPlaylistEntryByDmxId(ByVal playlistDmxFolderId As Integer,ByVal playlistDmxId As Integer,ByVal resourceDmxFolderId As Integer,ByVal resourceDmxId As Integer)**

Pushes back Playlist entry by given dmx id

- ▼ **AutoPushBackPlaylistEntryByPath(ByRef PlaylistPath As String PlaylistPath,ByRef ResourcePath As String ResourcePath)**

Pushes back Playlist entry by given path

- ▼ **AutoPushBackPlaylistEntryByItemId(ByVal playlistItemId As Integer,ByVal resourceItemId As Integer)**

Pushes back Playlist entry by given item id

- ▼ **AutoInsertPlaylistEntryByDmxId(ByVal playlistDmxFolderId As Integer,ByVal playlistDmxId As Integer,ByVal resourceDmxFolderId As Integer,ByVal resourceDmxId As Integer,ByVal index As Integer)**

Inserts new Playlist entry by dmx id

▼ **AutoInsertPlaylistEntryByPath(ByRef PlaylistPath As String PlaylistPath,ByRef ResourcePath As String ResourcePath,ByVal index As Integer)**

Inserts Playlist entry by path

▼ **AutoInsertPlaylistEntryByItemId(ByVal playlistItemId As Integer,ByVal resourceItemId As Integer,ByVal index As Integer)**

Inserts playlist entry by item id

▼ **AutoRemovePlaylistEntryByDmxId(ByVal playlistDmxFolderId As Integer,ByVal playlistDmxId As Integer,ByVal index As Integer)**

Removes Playlist entry by dmx id

▼ **AutoRemovePlaylistEntryByPath(ByRef PlaylistPath As String PlaylistPath,ByVal index As Integer)**

Removes Playlist entry by path

▼ **AutoRemovePlaylistEntryByItemId(ByVal playlistItemId As Integer,ByVal index As Integer)**

Removes Playlist entry by item id

▼ **AutoGetPlaylistSizeByDmxId(ByVal playlistDmxFolderId As Integer,ByVal playlistDmxId As Integer)**

Gets the number of items in Playlist

▼ **AutoGetPlaylistSizeByPath(ByRef PlaylistPath As String PlaylistPath)**

Gets the number of items in Playlist

▼ **AutoGetPlaylistSizeByItemId(ByVal playlistItemId As Integer)**

Gets the number of items in Playlist

▼ **AutoGetPlaylistEntryByDmxId(ByVal playlistDmxFolderId As Integer,ByVal playlistDmxId As Integer,ByVal entryIndex As Integer,ByVal pPlaylistEntryInfo As PlaylistEntry)**

Gets the Playlist entry of given Playlist at given position

▼ **AutoGetPlaylistEntryByPath(ByRef PlaylistPath As String PlaylistPath,ByVal entryIndex As Integer,ByVal pPlaylistEntryInfo As PlayListEntry)**

Gets the Playlist entry of given Playlist at given position

▼ **AutoGetPlaylistEntryByItemId(ByVal playlistItemId As Integer,ByVal entryIndex As Integer,ByVal pPlaylistEntryInfo As PlayListEntry)**

Gets the Playlist entry of given Playlist at given position

▼ **AutoGetPlaylistEntryIndicesByDmxId(ByVal playlistDmxFolderId As Integer,ByVal playlistDmxId As Integer,ByVal pData() As Byte,ByRef pSize As Integer)**

Not yet documented.

▼ **AutoGetPlaylistEntryIndicesByPath(ByRef PlaylistPath As String PlaylistPath,ByVal pData() As Byte,ByRef pSize As Integer)**

Not yet documented.

▼ **AutoGetPlaylistEntryIndicesByItemId(ByVal playlistItemId As Integer,ByVal pData() As Byte,ByRef pSize As Integer)**

Not yet documented.

▼ **AutoSetPlayListEntryIndexByDmxId(ByVal playlistDmxFolderId As Integer,ByVal playlistDmxId As Integer,ByVal index As Integer,ByVal newIndex As Integer)**

Sets Playlist entry by dmx id

▼ **AutoSetPlayListEntryIndexByPath(ByRef PlaylistPath As String PlaylistPath,ByVal index As Integer,ByVal newIndex As Integer)**

Sets Playlist entry by path

▼ **AutoSetPlayListEntryIndexByItemId(ByVal playlistItemId As Integer,ByVal index As Integer,ByVal newIndex As Integer)**

Sets Playlist entry by item id

- ▼ **AutoSetPlayListEntryDurationByDmxId(ByVal playlistDmxFolderId As Integer,ByVal playlistDmxId As Integer,ByVal index As Integer,ByVal hours As Integer,ByVal minutes As Integer,ByVal seconds As Integer,ByVal frames As Integer)**

Sets the duration of given Playlist item

- ▼ **AutoSetPlayListEntryDurationByPath(ByRef PlaylistPath As String PlaylistPath,ByVal index As Integer,ByVal hours As Integer,ByVal minutes As Integer,ByVal seconds As Integer,ByVal frames As Integer)**

Sets the duration of given Playlist item

- ▼ **AutoSetPlayListEntryDurationByItemId(ByVal playlistItemId As Integer,ByVal index As Integer,ByVal hours As Integer,ByVal minutes As Integer,ByVal seconds As Integer,ByVal frames As Integer)**

Sets the duration of given Playlist item

- ▼ **AutoSetPlayListEntryFadeOutTimeByDmxId(ByVal playlistDmxFolderId As Integer,ByVal playlistDmxId As Integer,ByVal index As Integer,ByVal hours As Integer,ByVal minutes As Integer,ByVal seconds As Integer,ByVal frames As Integer)**

Sets the fade out duration of given Playlist item

- ▼ **AutoSetPlayListEntryFadeOutTimeByPath(ByRef PlaylistPath As String PlaylistPath,ByVal index As Integer,ByVal hours As Integer,ByVal minutes As Integer,ByVal seconds As Integer,ByVal frames As Integer)**

Sets the fade out duration of given Playlist item

- ▼ **AutoSetPlayListEntryFadeOutTimeByItemId(ByVal playlistItemId As Integer,ByVal index As Integer,ByVal hours As Integer,ByVal minutes As Integer,ByVal seconds As Integer,ByVal frames As Integer)**

Sets the fade out duration of given Playlist item

- ▼ **AutoSetPlayListEntryInPointByDmxId(ByVal playlistDmxFolderId As Integer,ByVal playlistDmxId As Integer,ByVal index As Integer,ByVal hours As Integer,ByVal minutes As Integer,ByVal seconds As Integer,ByVal frames As Integer)**

Sets the entry's inpoint

- ▼ **AutoSetPlayListEntryInPointByPath(ByRef PlaylistPath As String PlaylistPath,ByVal index As Integer,ByVal hours As Integer,ByVal minutes As Integer,ByVal seconds As Integer,ByVal frames As Integer)**

Sets the entry's inpoint

- ▼ **AutoSetPlayListEntryInPointByItemId(ByVal playlistItemId As Integer,ByVal index As Integer,ByVal hours As Integer,ByVal minutes As Integer,ByVal seconds As Integer,ByVal frames As Integer)**

Sets the entry's inpoint

- ▼ **AutoSetPlayListEntryOutPointByDmxId(ByVal playlistDmxFolderId As Integer,ByVal playlistDmxId As Integer,ByVal index As Integer,ByVal hours As Integer,ByVal minutes As Integer,ByVal seconds As Integer,ByVal frames As Integer)**

Sets the entry's outpoint

- ▼ **AutoSetPlayListEntryOutPointByPath(ByRef PlaylistPath As String PlaylistPath,ByVal index As Integer,ByVal hours As Integer,ByVal minutes As Integer,ByVal seconds As Integer,ByVal frames As Integer)**

Sets the entry's outpoint

- ▼ **AutoSetPlayListEntryOutPointByItemId(ByVal playlistItemId As Integer,ByVal index As Integer,ByVal hours As Integer,ByVal minutes As Integer,ByVal seconds As Integer,ByVal frames As Integer)**

Sets the entry's outpoint

- ▼ **AutoSetPlayListEntryTransitionByDmxId(ByVal playlistDmxFolderId As Integer,ByVal fadeFxId As Integer)**

Sets the entry's transition

- ▼ **AutoSetPlayListEntryTransitionByPath(ByRef PlaylistPath As String PlaylistPath,ByVal index As Integer,ByVal fadeFxId As Integer)**

Sets the entry's transition

- ▼ **AutoSetPlayListEntryTransitionByItemId(ByVal playlistItemId As Integer,ByVal index As Integer,ByVal fadeFxId As Integer)**

Sets the entry's transition

- ▼ **AutoSetPlayListEntryNoteByDmxId(ByVal playlistDmxFolderId As Integer,ByVal playlistDmxId As Integer,ByVal index As Integer,ByRef Note As String Note)**

Sets the entry's note

- ▼ **AutoSetPlayListEntryNoteByPath(ByRef PlaylistPath As String PlaylistPath,ByVal index As Integer,ByRef Note As String Note)**

Sets the entry's note

- ▼ **AutoSetPlayListEntryNoteByItemId(ByVal playlistItemId As Integer,ByVal index As Integer,ByRef Note As String Note)**

Sets the entry's note

- ▼ **AutoRecordLiveInputById(ByVal folderID As Integer,ByVal fileID As Integer,ByRef Filename As String Filename,ByRef EncodingPreset As String EncodingPreset,ByVal durationHour As Integer,ByVal durationMin As Integer,ByVal durationSec As Integer,ByVal durationFrames As Integer)**

Records live input with given id

- ▼ **AutoRecordLiveInputByIdStart(ByVal folderID As Integer,ByVal fileID As Integer,ByRef Filename As String Filename,ByRef EncodingPreset As String EncodingPreset)**

Starts recording live input with given id

- ▼ **AutoRecordLiveInputStop()**

Stops recording live input

- ▼ **AutoRecordLiveInputByName(ByRef LiveInput As String LiveInput,ByRef Filename As String Filename,ByRef EncodingPreset As String EncodingPreset,ByVal durationHour As Integer,ByVal durationMin As Integer,ByVal durationSec As Integer,ByVal durationFrames As Integer)**

Records live input with given name

- ▼ **AutoRecordLiveInputByNameStart(ByRef LiveInput As String LiveInput,ByRef Filename As String Filename,ByRef EncodingPreset As String EncodingPreset)**

Starts recording live input with given name

- 
- ▼ **AutoExportVideo(ByRef Filename As String Filename,ByRef EncodingPreset As String EncodingPreset,ByVal seqNum As Integer,ByVal startHour As Integer,ByVal startMinute As Integer,ByVal startSec As Integer,ByVal startFrame As Integer,ByVal endHour As Integer,ByVal endMinute As Integer,ByVal endSec As Integer,ByVal endFrame As Integer)**

Exports video with given parameters

- ▼ **AutoEncodeFileByName(ByRef Filename As String Filename,ByRef Preset As String Preset)**

Encodes file by name

- ▼ **AutoEncodeFileById(ByVal folderID As Integer,ByVal fileID As Integer,ByRef Preset As String Preset)**

Encodes file by id

- ▼ **AutoEncodeFileToTargetByName(ByRef Filename As String Filename,ByRef TargetPath As String TargetPath,ByVal overwriteExisting As Boolean,ByRef Preset As String Preset)**

Encodes file to target by name

- ▼ **AutoEncodeFileToTargetById(ByVal folderID As Integer,ByVal fileID As Integer,ByRef TargetPath As String TargetPath,ByVal overwriteExisting As Boolean,ByRef Preset As String Preset)**

Encodes file to target by id

## 19 THIRD PARTY SOFTWARE

This chapter describes shortly how to use gmax, 3ds Max and Blender when working with 3D models. These third party applications allow creating 3D objects that can be used in the Warper or in Pandoras Box. If you are using a different 3D program please have a look at the end of this topic.

### File formats supported by Pandoras Box and the Warper

Objects for Pandoras Box Servers and Players are stored as .x-file format. This format is a DirectX file format that can be exported with most 3D applications such as 3ds Max, Maya and Cinema4D among many others. A separate export plugin might be required for your specific application in order to export to .x directly.

The Warper is not only restricted to x files, but accepts 3ds files and others as well. ([read more...](#)<sup>791</sup>)

### gmax, 3ds Max and Blender

This topic focuses on three programs. It is only a brief introduction into 3D modeling, more documentation and tutorials might be found using various internet sources.

The 3D web resource page for 3D models [www.turbosquid.com](http://www.turbosquid.com) offers a light version of 3ds Max for personal use that is called gmax. gmax unlike 3ds Max will allow you to learn the most basic modeling and texturing concepts of 3D objects and exporting to .x files with a 3rd party exporter.

The last program mentioned in this topic is the free and open-source 3D application Blender.

- [Object Creation with gmax](#)<sup>1593</sup>

- [Exporting Objects from 3ds Max](#)<sup>1614</sup>

- [Object Creation with Blender](#)<sup>1616</sup>

The chapter covering the [Warper](#)<sup>780</sup> might be of interest as well.

### Basic information you need to know when creating objects for Pandoras Box and the Warper

The chapter covering the [Warper](#)<sup>780</sup> includes [common 3D modeling term definitions](#)<sup>782</sup> that are quite useful. For example it includes explanations of the coordinate system used in Pandoras Box and the Warper as well as what units they are based on. UV Mapping is described too. This is a brief summary, as well of interest for those who use other programs than the ones described here:

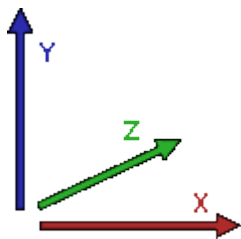

First of all, Pandoras Box' 3D space is based on a left-handed system. The units used are generic units defining that a screen's width is always 16 generic units. The camera's default position is  $(X,Y,Z) = (0,0,-25)$ . The FOV is set to 35,489 degree (or 56,251 mm). If a planar object is positioned at  $(0,0,0)$  and is 16 generic units wide, it fills exactly the fullscreen size. The height is calculated by the display's aspect ratio. For example, if working with an output set to 1920x1080px, the planar object should have a size of 16x9 units, if working with an output set to 1024x768px, the planar object should have a size of 16x12 units.

When exporting objects, make sure a UVW mapping is applied.

For gmax, coolux has created Native Files that consist of different planes (for different aspect ratios) and a camera. Again, If you would export the planar object as it is to an .x File and load it into Pandoras Box, the shape of a layer would not change, since this plane is a reference file to match the fullscreen scaling of a layer object. The camera helps us with a fixed view to see the boundaries of our output and allows us to create shapes that cross the boundaries.

When you use the files for warping, please make sure to always work within the camera view when shaping the grid. You may use the front view to work outside of the screen boundaries, but the camera view is a static reference for Pandoras Box.



If you have already started with your object in gmax and want to know how it would in Pandoras Box with the default settings applied, simply adjust the gmax camera in the above described way.

If using 3ds Max or Blender you can easily create this setup yourself.

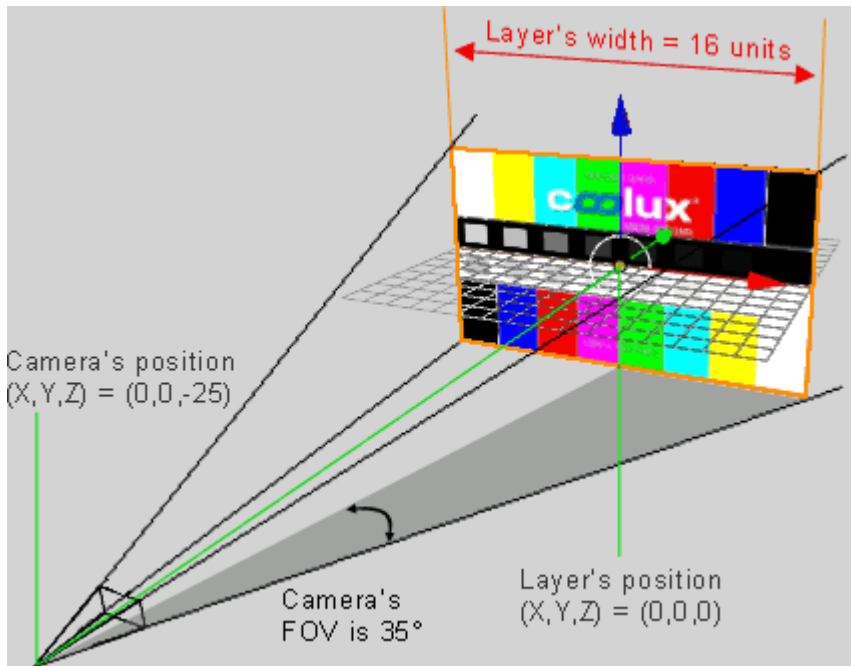

## 19.1 GMAX

As explained in the [introducing chapter](#)<sup>1592</sup>, gmax is a freeware 3D modeling program for personal use that allows you to do create 3D objects and to export them as .x files (with a 3rd party exporter) in order to use them in the Warper or in Pandoras Box.

[Gmax Software Setup](#)<sup>1593</sup>

[Overview object creation and export with Gmax](#)<sup>1594</sup>

[Screen warping with Gmax](#)<sup>1606</sup>

[Keyboard Shortcuts](#)<sup>1614</sup>

### 19.1.1 Software Setup



You may download gmax from the web resource page for 3D models [www.turbosquid.com](http://www.turbosquid.com).

coolux has programmed some additional files that can be downloaded from the Download-Center on the coolux website in order to improve the object creation and warping workflow. These files include:

- changes in the user interface that allow going into real fullscreen without any borders
- a default file including planes that stand for fullscreen objects with different aspect ratios as well as a

camera with correct position and lens settings  
 - an exporter plugin to be able to save an object as a \*.x file

After installing gmax, you may either download these files separately from the [Download-Center](#) and copy them into the according plugins,ui and scenes folder or simply run the [gmax\\_installer](#) that contains all needed files and copies them to the correct directory automatically. Please read the following topics for more detailed information.

Once gmax is installed and the plugin files are added to gmax, you may start the application. If you start gmax for the first time, you will be asked for your registration key that you can obtain by registering at [www.turbosquid.com](http://www.turbosquid.com). Once the key is entered, the application will ask, which 3D graphics hardware acceleration to choose for gmax. Choose "HEIDI" and "Software Z Buffer".

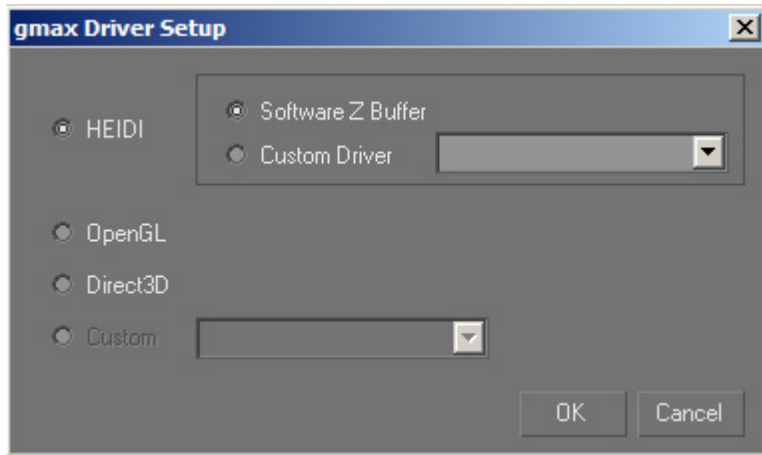

The next chapter will give an overview about [object creation and export](#)<sup>1594</sup>.

### 19.1.2 Object Creation and Export Using gmax

When creating a 3D object in gmax for Pandoras Box, it is helpful to use one of the PB Native Files. When exporting the Native File straight forward and importing it in Pandoras Box, it will fit exactly the fullscreen area as it is based on the coordinate system and camera settings used in Pandoras Box. Please make yourself familiar with the basics described in the [introducing chapter](#)<sup>1592</sup>.

There are different Native Files, which one you need depends on two facts:

- 1) Do you create the object for Pandoras Box version 4.1 or version 4.5 and higher?  
 From Pandoras Box version 4.5 on the 3D perspective has been adjusted to match any output aspect ratio. For this reason 3D objects created for PB version 4.1 won't exactly match when being used with PB version 4.5.
- 2) Do you want to use the (recommended) PB Exporter or the gmax Internal Aircraft Flightsim Exporter?  
 Generally, an exporter converts the gmax object to an \*.x file to be imported in Pandoras Box. The exporters have different ways to convert units, thus the original file must have a different size.

The following table explains which Native File is needed and includes download links for the coolux' Download-Center.

PB Version	Exporter	Name of correct native file	Aspect Ratio
4.1	<a href="#">gmax International Flightsim Aircraft Exporter</a>	<a href="#">PB Native 4to3 Scale</a>	4:3
		<a href="#">PB Native 16to9 Scale</a>	16:9
4.5 and higher		<a href="#">PB Native v4.5</a>	4:3, 16:9, 16:10, 5:4

	PB Exporter (included in <a href="#">gmax_installer</a> )	<a href="#">PB Native v4.5 PB Exporter</a>	4:3, 16:9, 16:10, 5:4
--	--	--	-----------------------

The different native files can be downloaded separately from the [Download-Center](#) to be copied into the "scenes" subfolder in the gmax installation folder. The files for the gmax International Flightsim Aircraft Exporter have to be copied to the "plugins" folder.

Alternatively, you may run the [gmax\\_installer](#) that contains the following files which are copied to the correct directory automatically:

- both exporters, the gmax International Flightsim Aircraft Exporter and the PB Exporter
- files that are needed to be able to go into real fullscreen
- the "PB Native v4.5 PB Exporter" file

See here further explanations for

- [General object creation with Gmax](#)<sup>1595</sup>: a tutorial showing the basic steps through a simple object creation and mapping process
- [Object creation and export for PB Vers. 4.1](#)<sup>1599</sup>: shows how to export an object for PB version 4.1
- [Object creation and export up from PB Vers. 4.5](#)<sup>1600</sup>: shows two ways how to export an object for PB version 4.5
- [Warping with gmax](#)<sup>1606</sup>: a tutorial showing more advanced steps in gmax and how to warp
- [gmax keyboard shortcuts](#)<sup>1614</sup>

**19.1.2.1 General Object Creation in gmax**

The following tutorial will show you the basic steps through a simple object creation and mapping process. Furthermore it explains the pattern to export to an x-file from gmax. This topic assumes that you are familiar with the basics described in the [introducing chapter](#)<sup>1592</sup>.

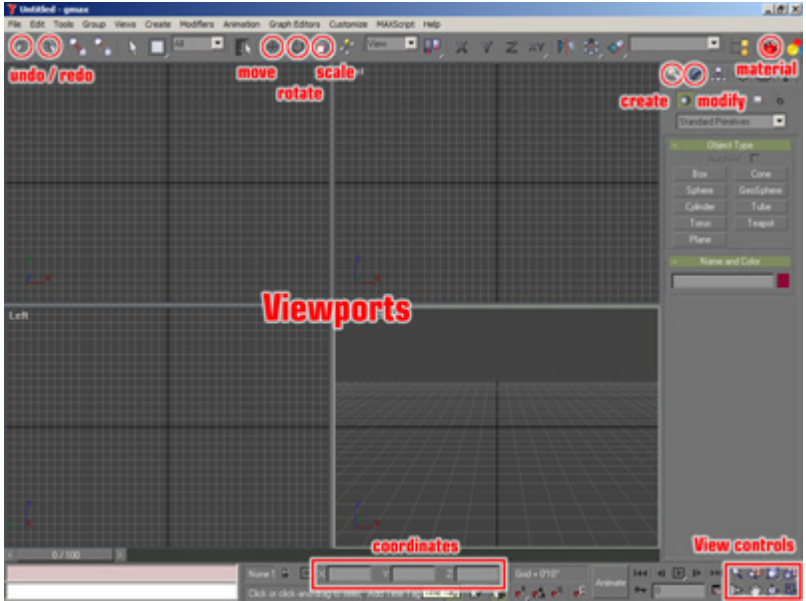

All most important features to start with are outlined in red.

**Creating a box object and applying a texture**

1. Click on Box in the create tab.
2. Draw the Box with the mouse in the front view (upper right viewport), by left clicking and holding the mouse to define the front face size. Once the mouse left click is released, you can continue moving the mouse up and down to determine the depth of the box.

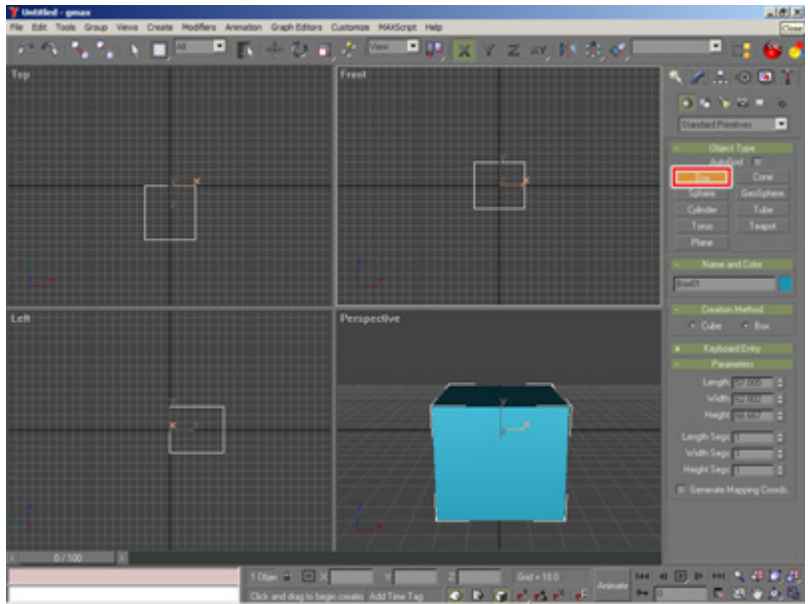

Once the box is created, you will need to assign the texture coordinates to the object in order to define how the texture should be displayed on the surfaces of the box.

Therefore go to the Modify tab while the object is still selected (object is outlined white while selected) and apply a "UVW MAP" modifier from the pull down list to the object.

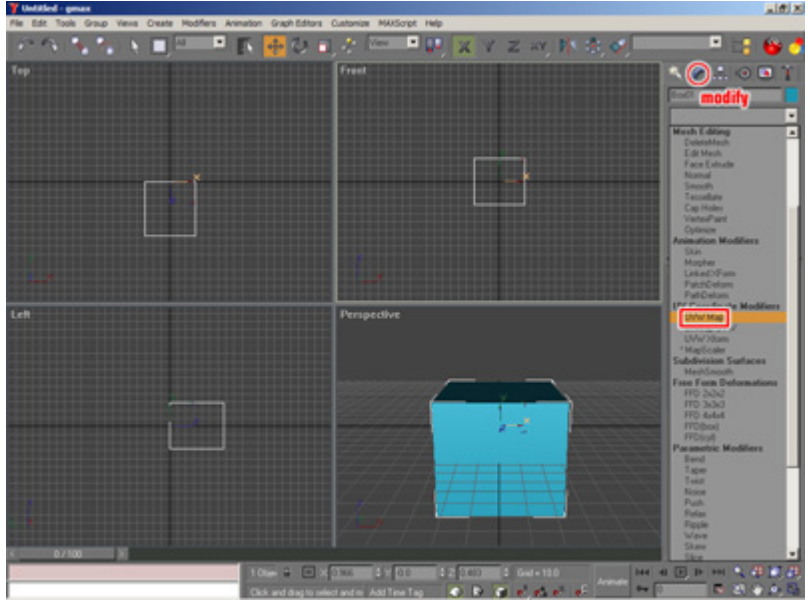

Once the "UVW MAP" modifier is applied to the object, you will see an orange outline that shows you how the texture is projected on the object.

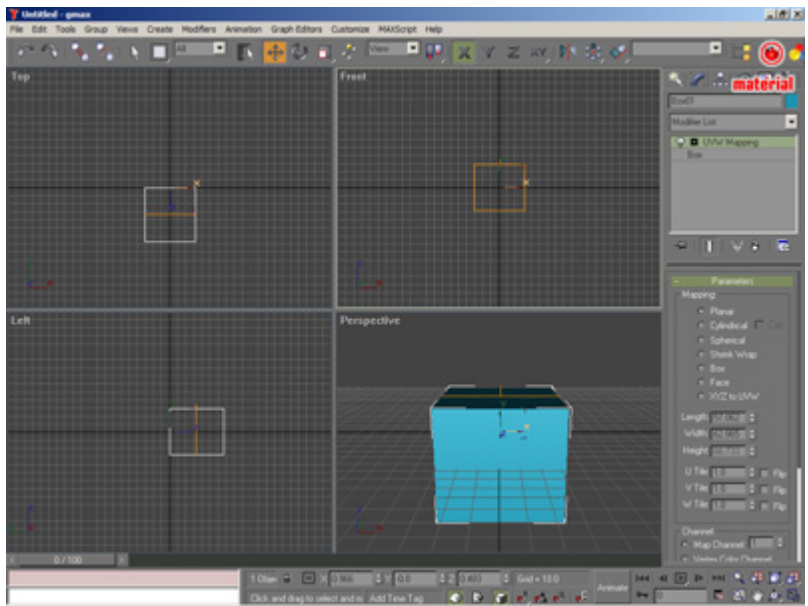

The last setup before exporting the file as .x you will have to apply a material with a diffuse channel to the object so that Pandoras Box can use this texture channel to map images on it. To create a new material click on the Material icon or use the keyboard shortcut "M" to open the Material Editor.

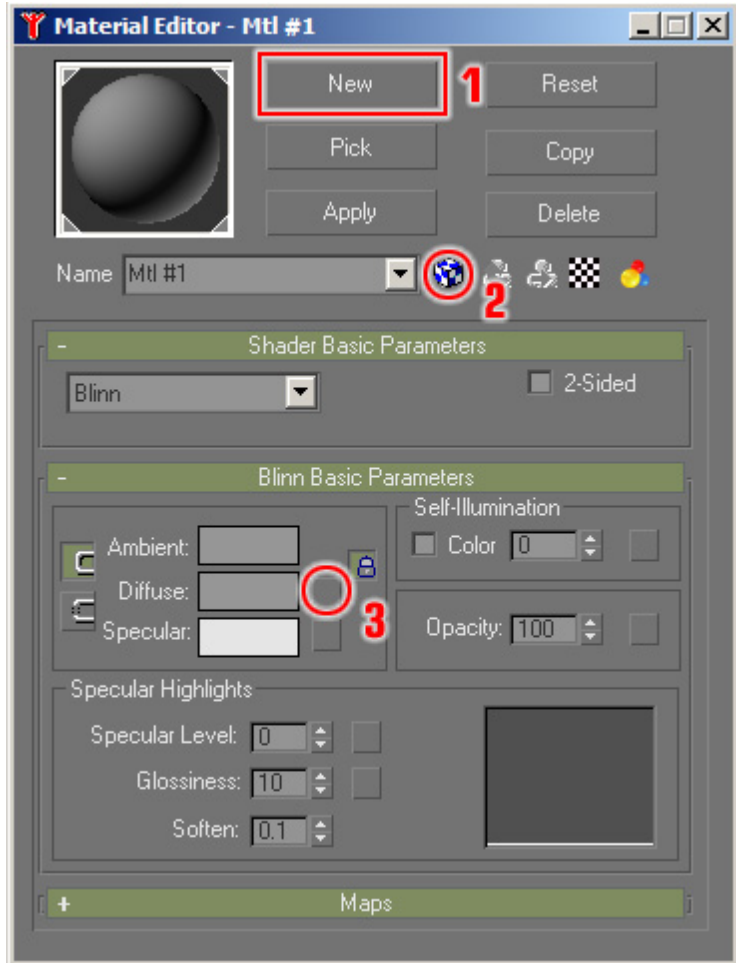

1. Create a new material
2. Toggle checked box to show texture in shaded viewport
3. Click on square box of the Diffuse channel

Choose bitmap from the dialog to assign a bitmap to the diffuse texture channel.

Next choose a bitmap from the opening file browser.

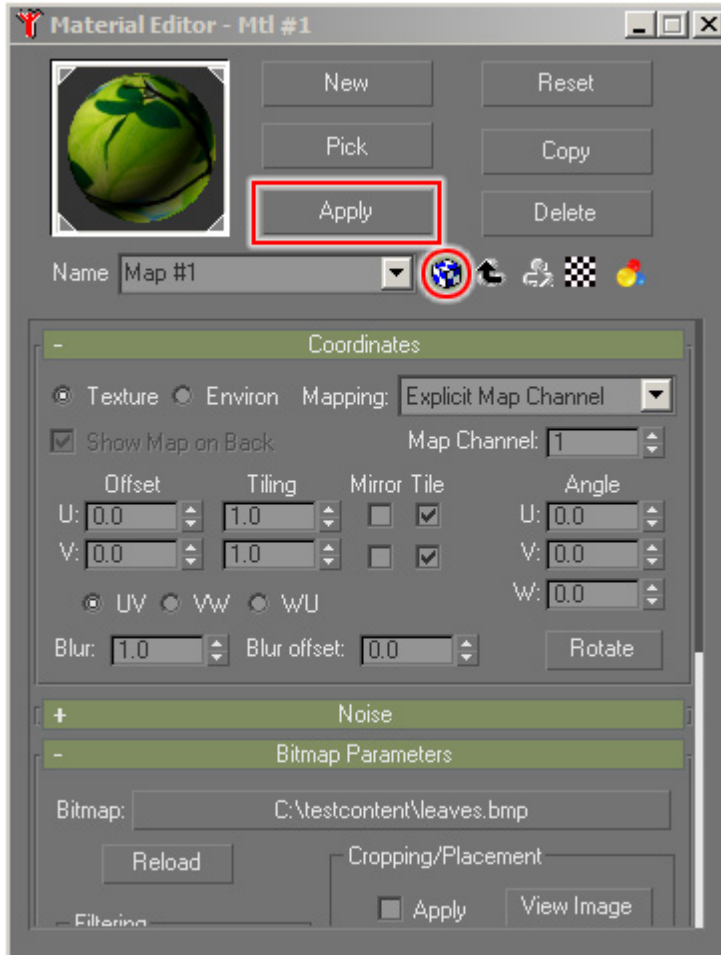

Now apply the material to the selected object by clicking "Apply" and you should be able to preview your mapping in the perspective viewport of gmax right away. If you do not see the texture in the viewport, the object was either not selected, the checked box not toggled or none of your views is in shaded preview (F3).

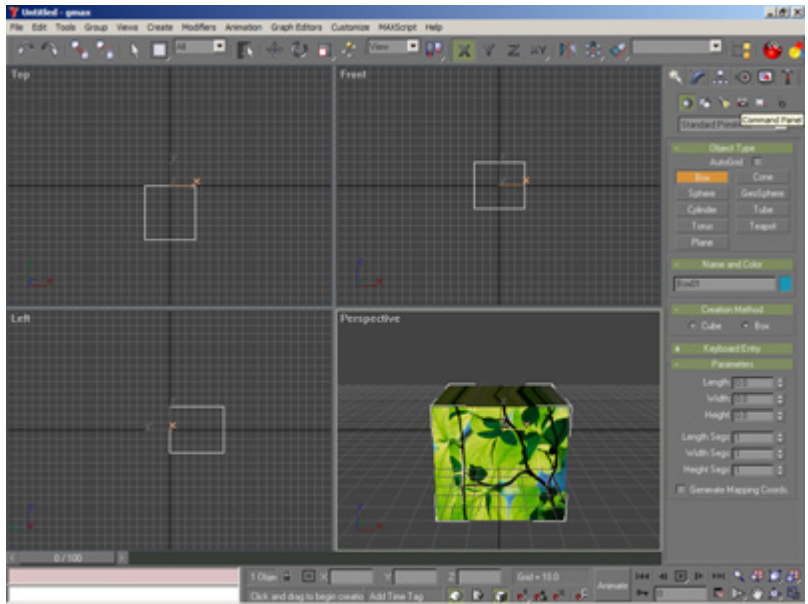

**Exporting an object**

Before exporting the object for Pandoras Box you will have to make sure that it's placed correctly, since the 0,0,0 is relevant for the pivot point of an object once this is used in Pandoras Box.

To place the object right in the center, use the move tool from the main toolbar in gmax.

As last step you have to export your file as .x-file, for further information please see:

- [Gmax Object Export for PB Vers. 4.1](#)<sup>1599</sup> or
- [Gmax Object Export for PB Vers. 4.5](#)<sup>1600</sup>.

**19.1.2.2 Object Creation and Export for PB Version 4.1**

As explained in the [introducing chapter](#)<sup>1594</sup> the Native File "[PB Native 4to3 Scale](#)" and the "[gmax International Flightsim Aircraft Exporter](#)" are needed. You may download the files separately and copy them to the "scenes" and "plugins" subfolder in the gmax installation folder. Alternatively, you may run the [gmax\\_installer](#) that contains all needed files and copies them to the correct directory automatically. Please restart gmax after copying the plugin files. If running the fullscreen edition all commands are accessible within the context menu, please right-click into one of the four viewports to open it. Choose "File" > "Open" to load a file.

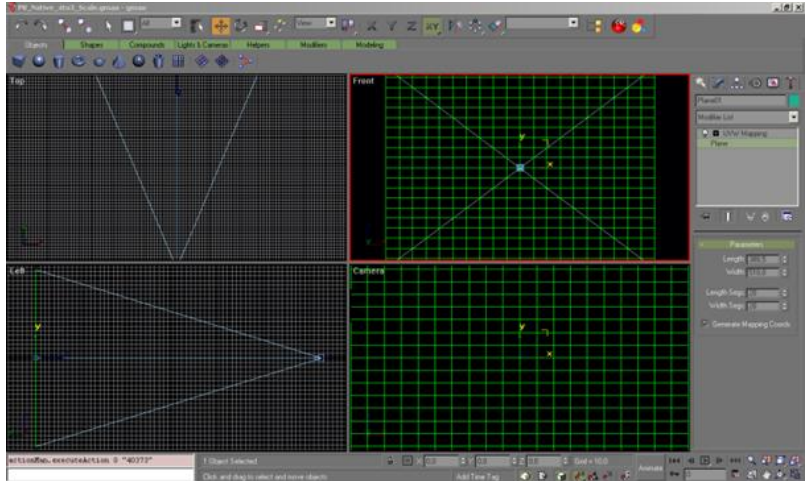

PB Native 4to3 Scale contains a flat planar object and a camera. If you would export the planar object as it is to an .x File and load it into Pandoras Box, the shape of a layer would not change since this plane is a reference file to match the full screen scaling of a layer object.

The camera helps us with a fixed view to see the boundaries of our output and allows us to create shapes that cross the boundaries. Please make sure to always work within the camera view when shaping the grid. You may use the front view to work outside of the screen boundaries, but the camera view is a static reference for Pandoras Box.

If you finished editing your object, you have to export it.

### Exporting an object for PB version 4.1 using the Flightsim Aircraft Exporter

To export the object, make sure it is selected by clicking on it and then choose from the file menu "export selected". Export selected as "Flightsim Aircraft Object (\*.MDL)".

Since the Flightsimulator uses different units a message box will pop up, simply click "OK" to continue.

In the next dialog that opens go to Options and check "xfile" and "no compile" and click on "GO".

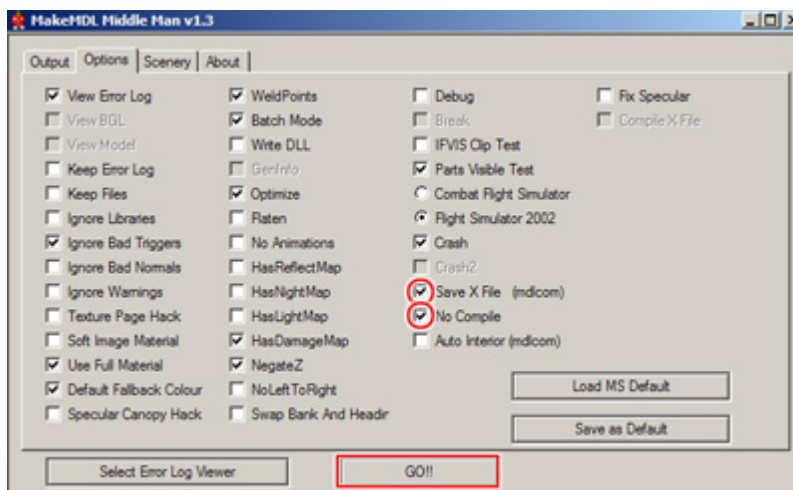

You might save the options so that you don't have to check this at every export by clicking "Save as Default".

The object is now properly exported as .x file and can be loaded into Pandoras Box.

### 19.1.2.3 Object Creation and Export for PB Version 4.5

As explained in the [introducing chapter](#)<sup>1594</sup> you have two opportunities to export your 3D object for Pandoras Box version 4.5 (or higher). You may use the following exporters:

- the [Flightsim Aircraft Exporter](#)<sup>1601</sup> or
- the [Pandoras Box Exporter Script](#)<sup>1603</sup>.

The difference between these two exporters is their handling of unit conversion. Via the flightsimulator plugin the scalings are always transformed to an inch based measuring system, the PB Exporter script transforms the units 1:1. Both exporters will give you the same result, but you have to use different PB Native Setup files, which gives you reference to the camera settings inside Pandoras Box.

The flightsimulator plugin can be downloaded separately and be copied to the "plugins" subfolder in the gmax installation folder. Alternatively, you may run the [gmax\\_installer](#) that contains both exporters and other files needed and copies them to the correct directory automatically.



Please restart gmax after copying the plugin files.

### 19.1.2.3.1 Export Using Flightsim Aircraft Exporter Plugin

As explained in the [introducing chapter](#)<sup>1594</sup>, when exporting with the "[gmax International Flightsim Aircraft Exporter](#)" for Pandoras Box version 4.5 and higher, the Native File "[PB Native v4.5](#)" is needed. Please run the [gmax\\_installer](#) that contains all needed files and copies them to the correct directory automatically or download the files separately before starting gmax.

If running the fullscreen edition all commands are accessible within the context menu, please right-click into one of the four viewports to open it. Choose "File" > "Open" to load a file.

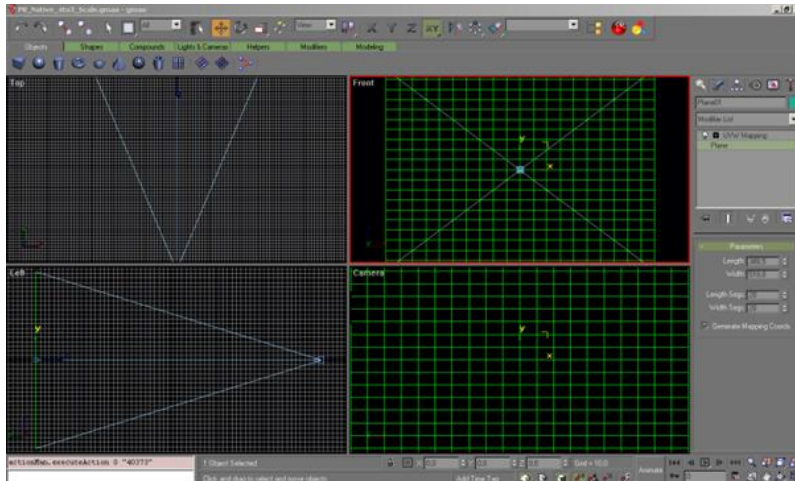

The PB Native 4.5 Setup File contains several items:

- four flat planar objects with different aspect ratios: 4:3 (visible) and 16:9, 16:10, 5:4 (hidden)
- a camera.

If you would export the 4:3 planar plane as it is to an .x File and load it into Pandoras Box, the shape of a layer would not change since this plane is a reference file to match the full screen scaling of a layer object.

If you need another aspect ratio you want to fit your layer or camera to, like 16:9, 16:10 or 5:4, please do a right-click on the plane to open the context menu and choose Hide > Unhide All. Then, via the Select by Name-Tool (found in the toolbar) you can choose another aspect ratio and confirm with clicking the "Select" Button. Open the context menu again by right-clicking and this time, choose Hide > Hide Unselected.

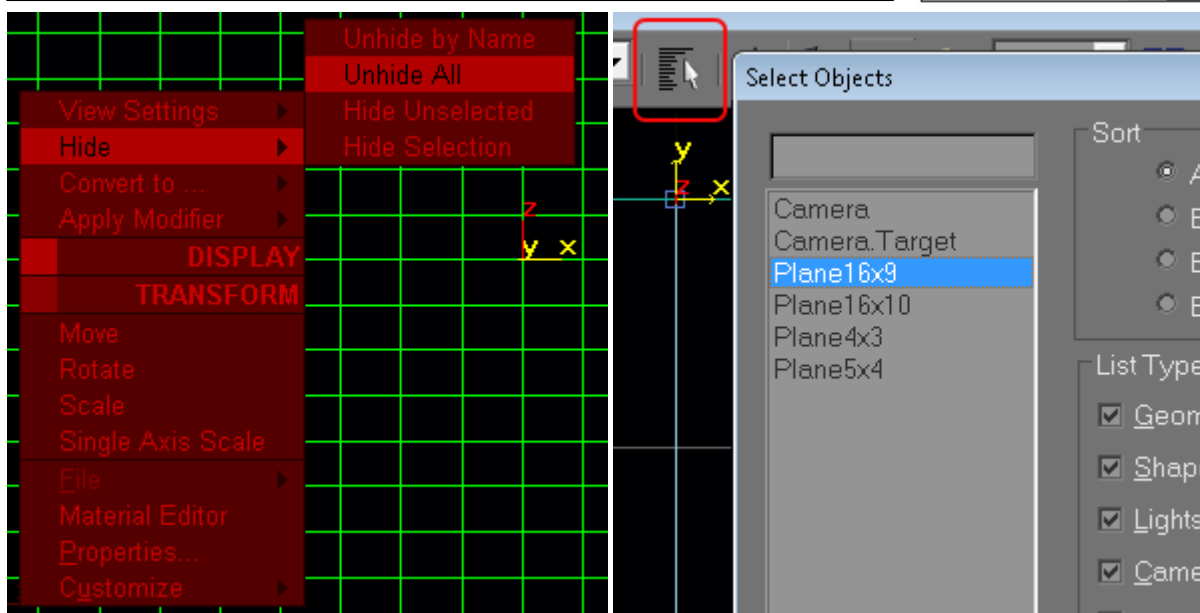

The camera helps us with a fixed view to see the boundaries of our output and allows us to create shapes that cross the boundaries. Please make sure to always work within the camera view when shaping the grid. You may use the front view to work outside of the screen boundaries, but the camera view is a static reference for Pandoras Box.

### Exporting an object for PB version 4.5 using the Flightsim Aircraft Exporter

To export the object, make sure it is selected by clicking on it and then choose from the File > Export Selected from the right-click menu. Export selected as "Flightsim Aircraft Object (\*.MDL)".

Since the Flightsimulator uses different units a message box will pop up, simply click "OK" to continue.

In the next dialog that opens go to Options and check "xfile" and "no compile" and click on "GO".

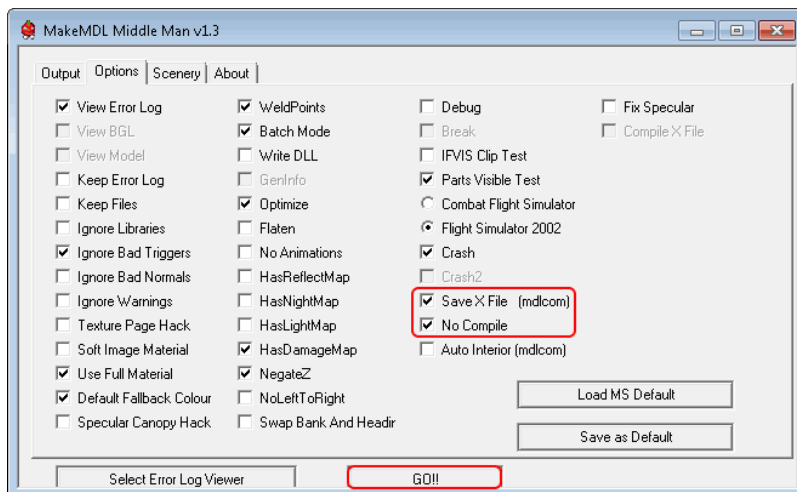

You might save the options so that you don't have to check this at every export by clicking "Save as Default".

The object is now properly exported as .x file and can be loaded into Pandoras Box.

### 19.1.2.3.2 Export Using the PB Exporter Script

As explained in the [introducing chapter](#)<sup>1594</sup>, when exporting with the "PB Exporter" for Pandoras Box version 4.5 and higher, the Native File "[PB Native v4.5 PB Exporter](#)" is needed. Please run the [gmax\\_installer](#) that contains all needed files and copies them to the correct directory automatically before starting gmax.

If running the fullscreen edition all commands are accessible within the context menu, please right-click into one of the four viewports to open it. Choose "File" > "Open" to load a file.

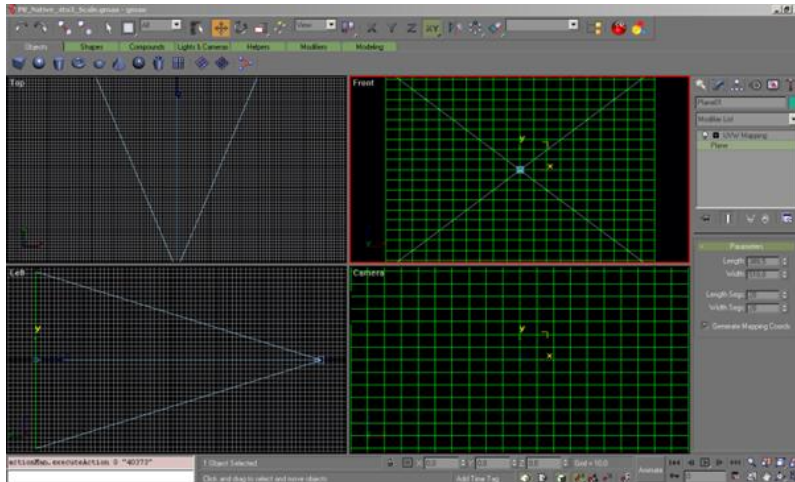

The PB Native 4.5 Setup File contains several items:

- four flat planar object, with different aspect ratios: 4:3 (visible) and 16:9, 16:10, 5:4 (hidden)
- a camera.

If you would export the 4:3 planar plane as it is to an .x File and load it into Pandoras Box, the shape of a layer would not change since this plane is a reference file to match the full screen scaling of a layer object.

If you need another aspect ratio you want to fit your layer or camera to, like 16:9, 16:10 or 5:4, please do a right-click on the plane to open the context menu and choose Hide > Unhide All.

Then, via the Select by Name-Tool (found in the toolbar) you can choose another aspect ratio and confirm with clicking the "Select" Button. Open the context menu again by right-clicking and this time, choose Hide > Hide Unselected.

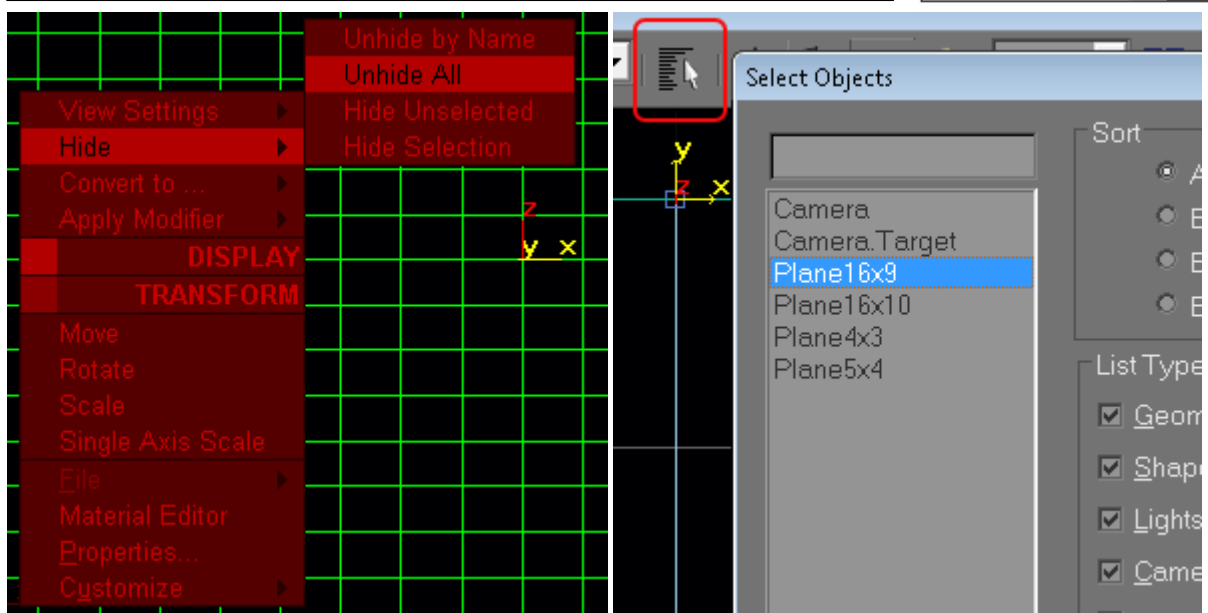

The camera helps us with a fixed view to see the boundaries of our output and allows us to create shapes that cross the boundaries. Please make sure to always work within the camera view when shaping the grid. You may use the front view to work outside of the screen boundaries, but the camera view is a static reference for Pandoras Box.

### Exporting an object for PB version 4.5 using the PB Exporter

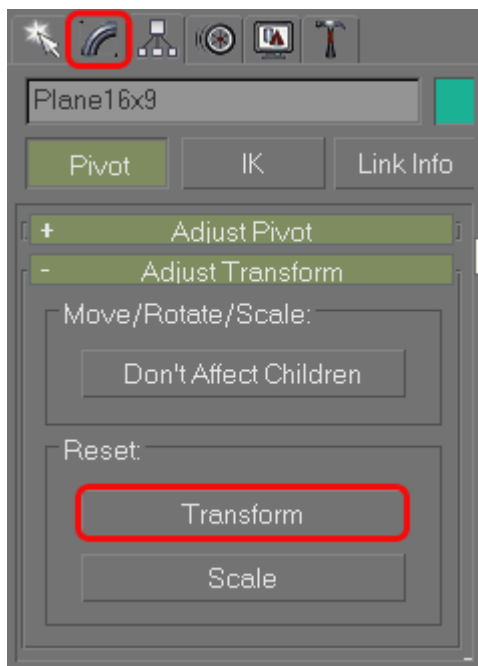

Before exporting the finished object via PB Exporter, please navigate to Hierarchy tab.

In the region "Adjust Transform" click on Reset: [Transform].

This rotates the axis inside Gmax to fit to Pandoras Box.

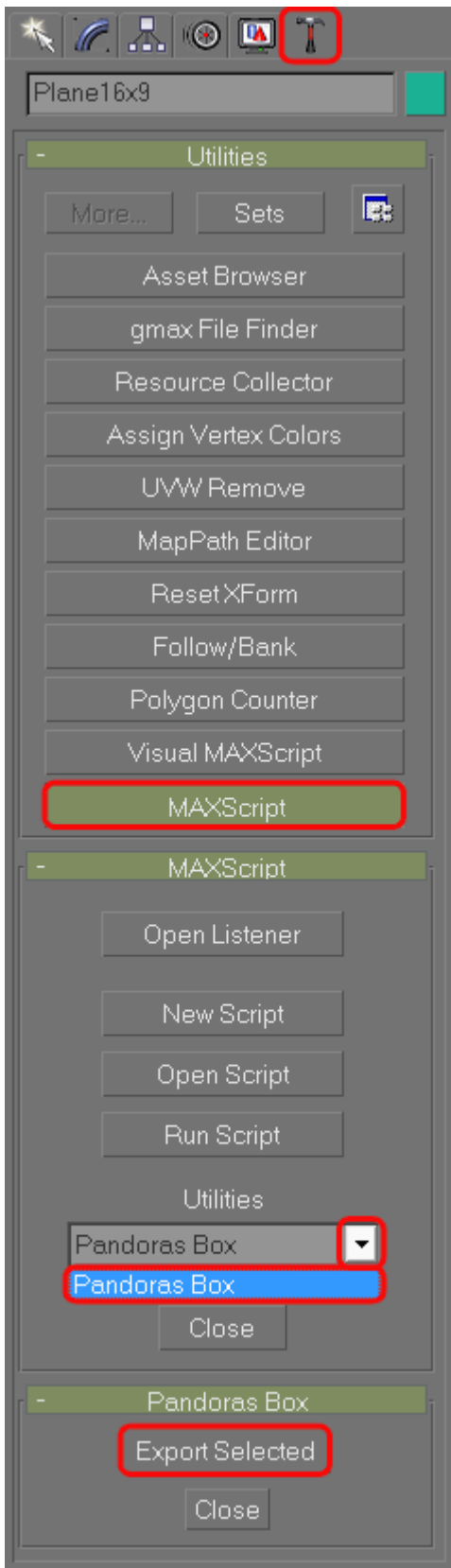

Please navigate to the Utilities Tab now.

Click on MAXScript, and you will get the following menu below the MAXScript button:

If you now unfold the Utilities list and choose the Pandoras Box Exporter again, below the list you will get the export option.

After you clicked [Export Selected], a Dialog opens and asks you to run the Pandoras Box Exporter. Please execute this exporter (PB GMAX X File Exporter.exe) that you downloaded.

Choose a file location and your x-file will be created there.

### 19.1.3 Warping with gmax

Pandoras Box provides the ability to use shapes and objects for any display output to be rendered to. This tutorial is intended to show the basic steps for correcting curved screens. If you are interested in warping please have a look at the [Warper<sup>780</sup>](#) too. It was developed by coolux to ease the warping process and provides specialized tools to optimize the workflow.

As gmax is an extensive and powerful 3D modeling tool we will only scratch the surface of 3D modeling in this tutorial.

Geometric correction has to be set up on-site with the projector hooked up to your system and running gmax in full-screen.

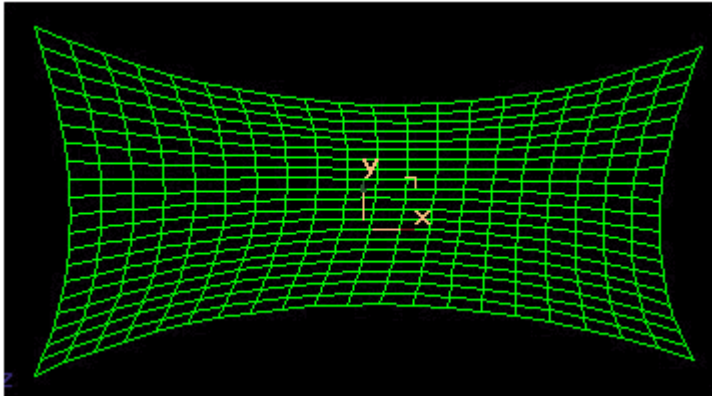

#### First steps: Adjusting the view settings

In order to get started, make sure that gmax is installed properly on your system. If you need to work from a distance, use a remote desktop viewer like Real VNC to mirror the output of the projectors on your laptop or PC.

To gain a maximum warping area, make sure that the Windows taskbar is not set to be "on top of other windows" by right-clicking on the windows taskbar and choosing its properties dialog.

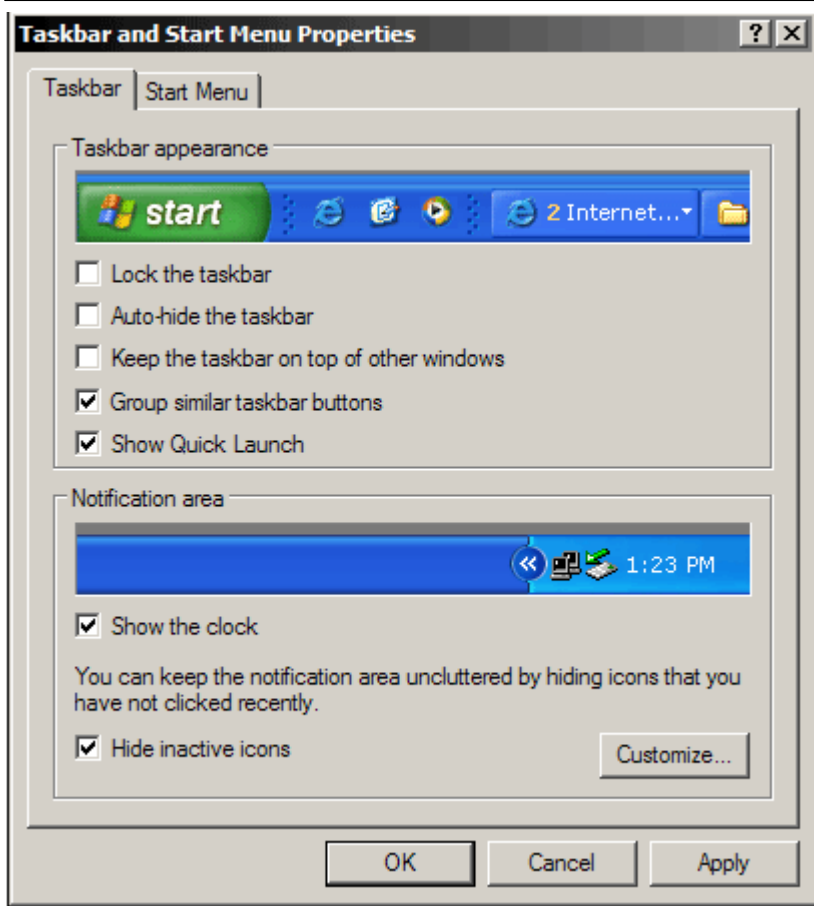

Start gmax.

If you need to setup two outputs simultaneously, start gmax in **Desktop extended mode** once for each screen so that you can edit two warping grids at the same time.

Once gmax is started it is recommended to adjust the following settings for a better workflow during the screen shaping process:

First of all we want to make sure that the background is all black and that all lines to be edited turn to primary green. This makes it much easier to see the grid in most lighting conditions.

To do this, click on Customize User Interface in the Main menu. Follow these steps:

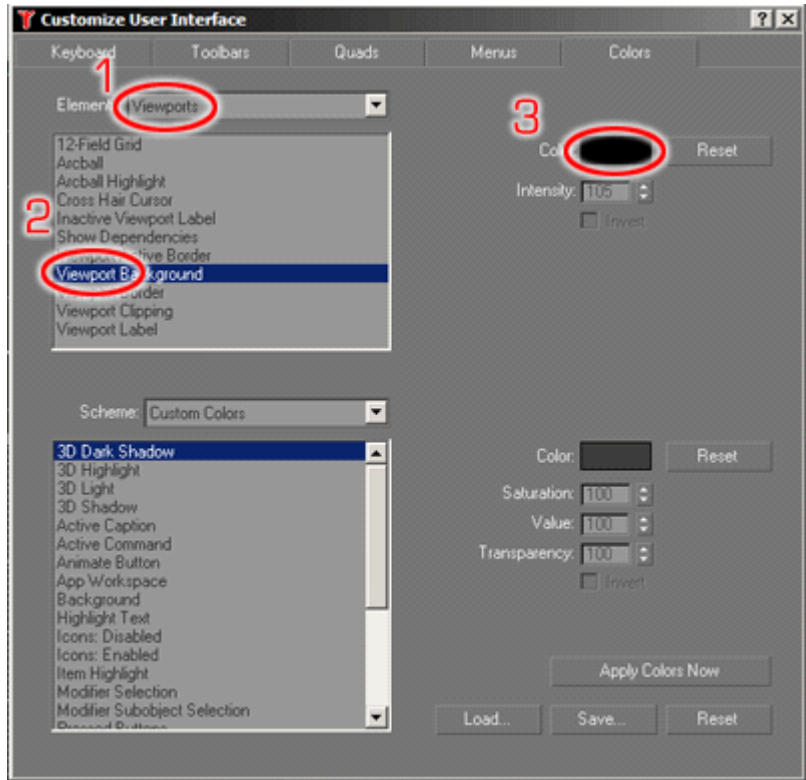
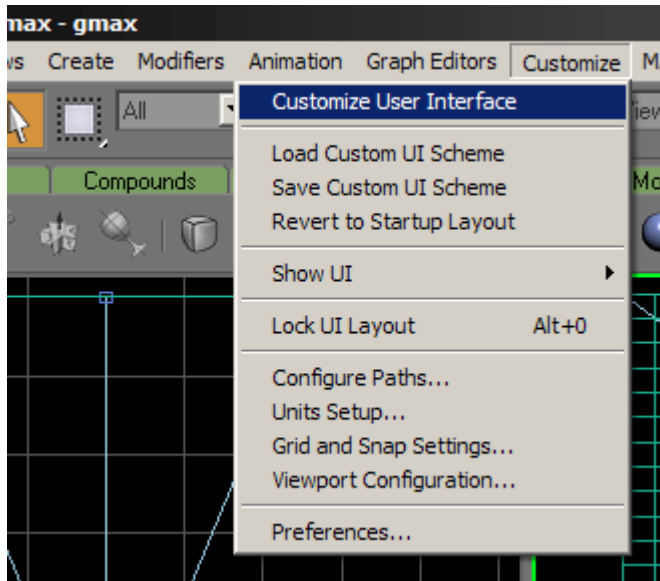

1. Select Viewports from the Elements pull-down menu
2. Choose Viewport Background
3. Change the colour in the colour dialog to black



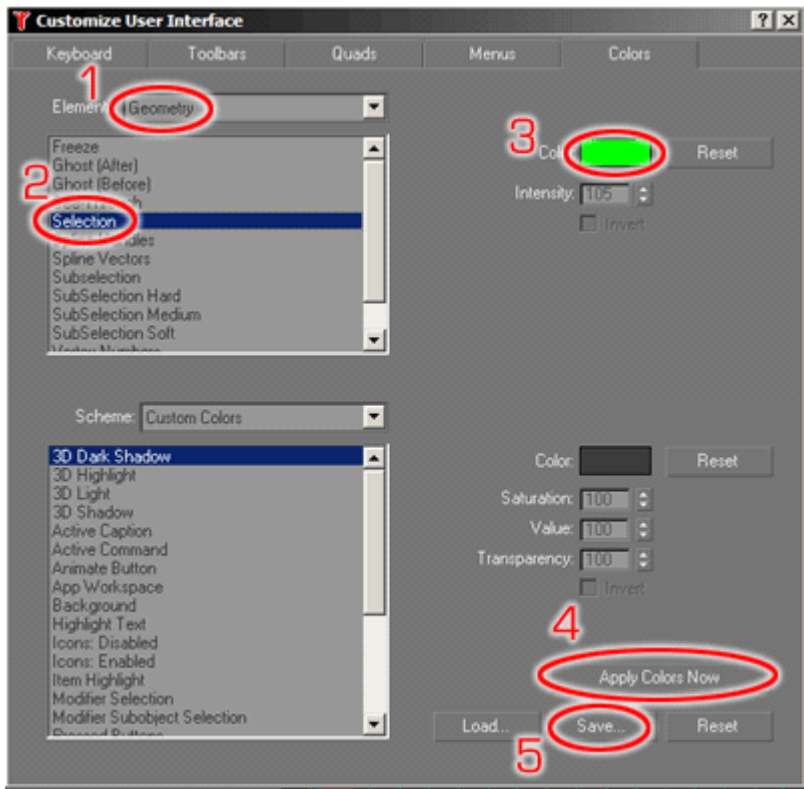

1. Select Geometry from the Elements pull-down menu
2. Choose Selection
3. Change the colour in the colour dialog to primary green
4. Apply the new settings
5. Save these settings for the future in File dialog by overwriting the default colour file.

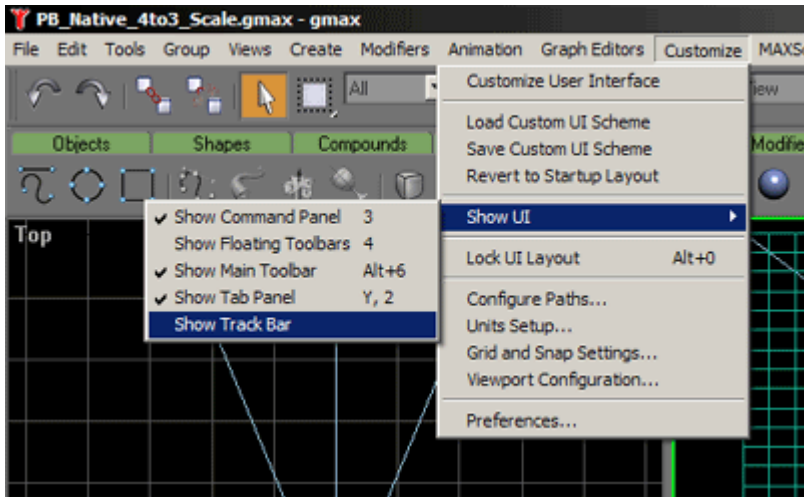

Last, make sure to hide the track bar from the main UI by u-checking "Show Track Bar".

Now you are ready to start warping! Please always make sure that your gmax is set up this way, these settings are important for working in expert mode with gmax in order to use the full desktop.

## How to warp using a plane

In this next section we will look at the basic deformation of a flat planar object. This tutorial is based on the steps explained in the [previous chapters](#)<sup>1594</sup>, please be sure to have downloaded the according gmax PB Native File and Exporter.

The most common task for screen shaping is a curved screen. To achieve this task, the planar object must be modified. The grid points have to be re-arranged in a way that the grid unwraps itself on the curved surface of your screen. To do this, all you need to do is to apply a tool that allows bending and shaping of planar objects.

In order to apply a new tool or a so called "modifier" in gmax, first select the planar object by clicking on it. Once it is selected it should turn primary green.

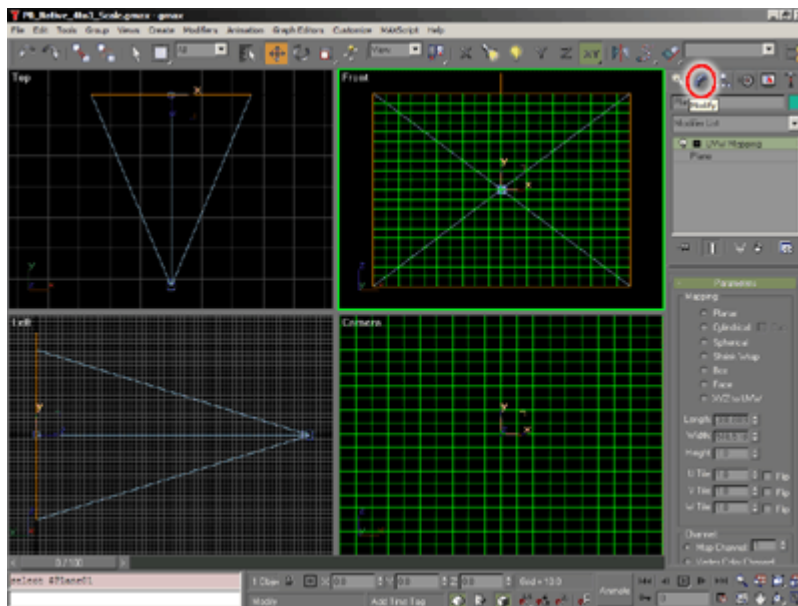

To apply a new modifier to the selected object you will need to switch to the modify mode by clicking on the "Modify" tab. Here you will see a hierarchy list of the history of the objects modifiers.

In order to apply a new one, select FFD 3x3x3 from the pull down menu.

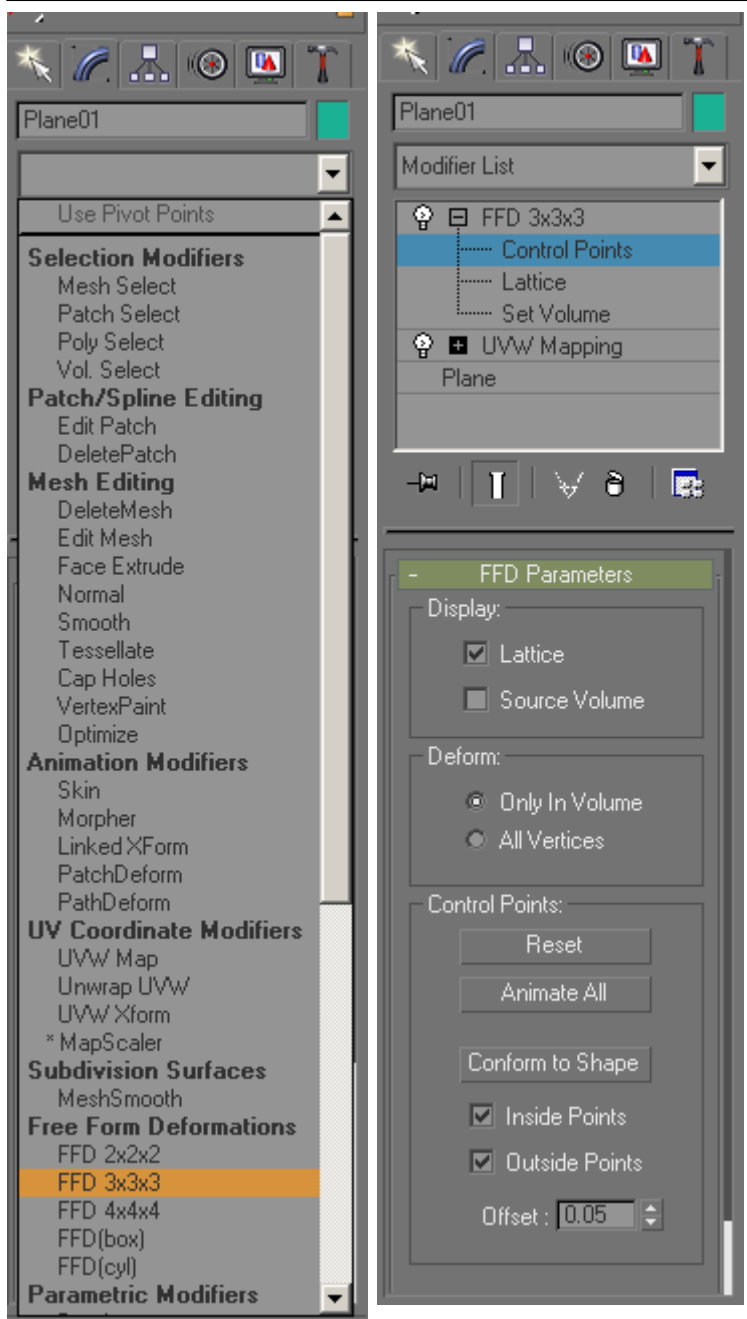

Then open the FFD 3x3x3 modifier in the stack and click on the Control Point level. Now you should see a 9 point orange control point grid surrounding the planar object.

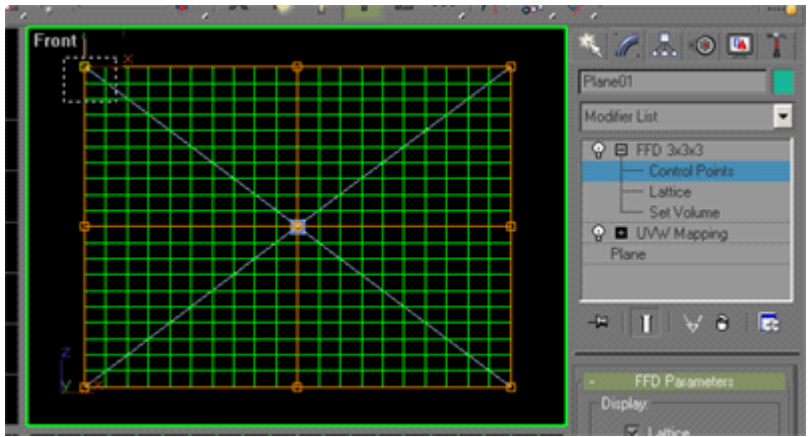

Since gmax and all objects are always treated as 3D objects, the modifier works also in the 3rd dimension. Therefore there are 2 more control points underneath each of the 9 points . Since the object that we want to modify is totally flat we need to make sure to always catch all three control points by dragging a selection window over the control points.

Now feel free to select and move the control points around to get a feeling of the dynamic behavior of the underlying planar grid according to the control points positions.

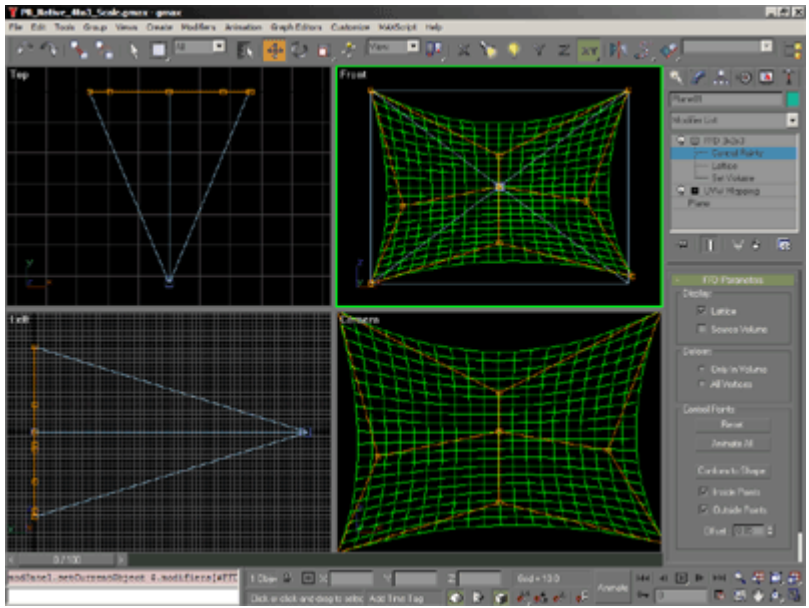

**Please Note:** Always make sure that none of your points moves towards the Z axis, all control points must stay at the same distance from the camera at all times. To control this, check your control points positions in the top and left view.

You might wonder how you can actually draw and shape this plane according to your screen, the answer is only a few clicks away.

In order to control the FFD's Control points you are in the control point level of the selected objects modifier stack. Once you are in this mode you can right-click in the camera view and press CTRL+X to toggle to the expert fullscreen mode of gmax. By pressing "W" on the keyboard you may toggle to the maximized camera view.

Now start modeling your planar object according to the physical shape of the screen.

If you need to toggle to the front view while in expert mode, you may use the "F" key for front view, "L" for left view and "C" for the camera view. The last gmax chapter includes all available [shortcuts](#)<sup>1614</sup>.

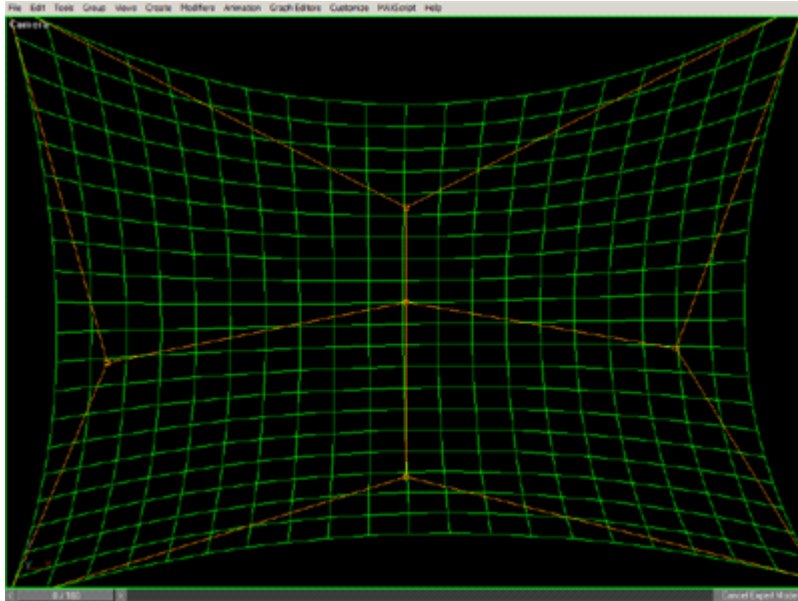

Please make sure that you make all adjustments to match your screens only according to the camera view, as this is your reference view for Pandoras Box output.

Once you're done with shaping the screen, you only have to export the selected object from the file menu and load the object into the output camera.

Anytime you need to get more detailed control over every grid point, explore the "edit mesh" modifier. Just add it to the stack and choose the Vertex level for in depth control of every segment of the shape.

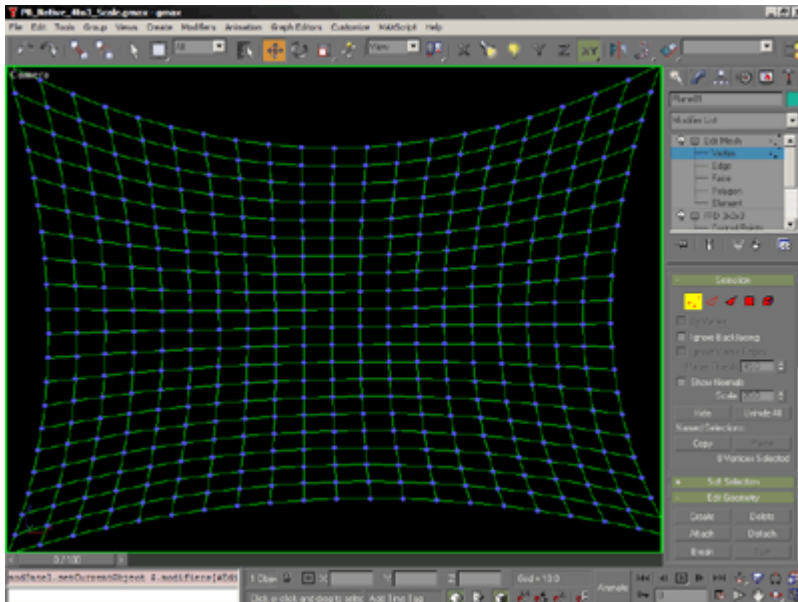

This modifier will do a great job when you do Softedge setups with over-laying grids. The Edit Mesh modifier will allow you to get the overlapping vertices accurately on top of each other for a perfect shaped Softedge blend.

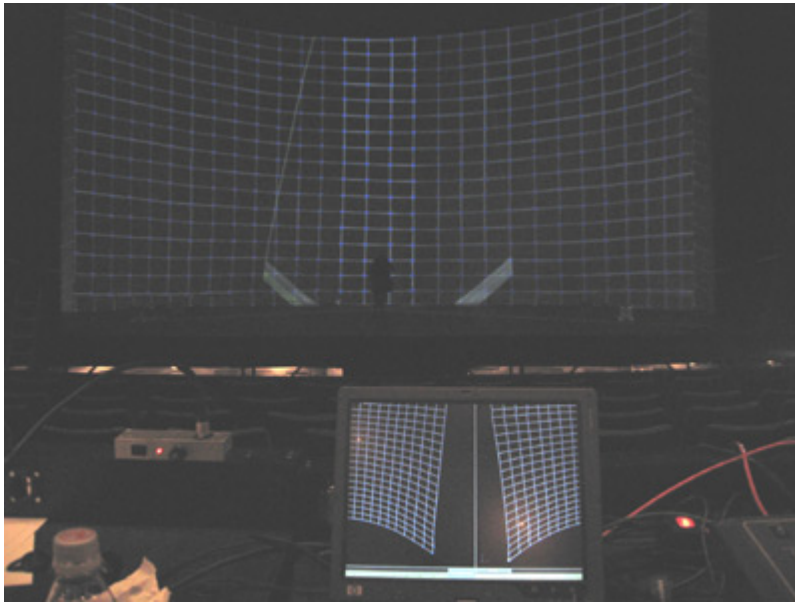

For this 180 degree screen, two gmax applications are edited at the same time. In the overlapping zone all vertices were touched up to match exactly the screen deformation.

### Exporting an object

Please export your file as an \*.x-file. as described in the previous chapters:

- [gmax Object Export for PB Vers. 4.1](#)<sup>1599</sup> or
- [gmax Object Export for PB Vers. 4.5](#)<sup>1600</sup> (and higher)

### 19.1.4 gmax Keyboard Shortcuts

F3 - Toggle textured view  
 F4 - Toggle grid on textured view

F - Front View  
 C - Camera View  
 L - Left View  
 R - Right View  
 T - Top View  
 P - Perspective View

G - Toggle Background Grid

Ctrl+X - Toggle Fullscreen Mode

X - Toggle XYZ Axis Control

### 19.2 3ds MAX

Please make yourself familiar with the basics described in the [introducing chapter](#)<sup>1592</sup>. You need to know them when using 3ds Max to create objects to be used in the [Warper](#)<sup>780</sup> or in [Pandoras Box](#)<sup>94</sup>. Even more detailed information can be found in the Warper's chapter "[General 3D Modeling Terms](#)<sup>782</sup>".

If you like to learn how to [generally create an object](#)<sup>1595</sup>, please refer to the chapter in gmax as these programs are very similar.

The next chapter describes the [X-File Exporter in 3ds Max](#) <sup>1615</sup>.

### 19.2.1 X-File Exporter for 3ds Max

When creating a warping grid or 3D objects with 3ds Max, you will need to install the x-file exporter in order to use the object with Pandoras Box.

We recommend using the Panda DirectX Exporter, it can be downloaded here: [http://www.andytather.co.uk/Panda/directxmax\\_downloads.aspx](http://www.andytather.co.uk/Panda/directxmax_downloads.aspx). Choose the Pandasoft Version according to your 3ds Max Version and install it, following the installing instructions on the website.

Please see here the recommended x-file exporting settings for 3ds Max 5:

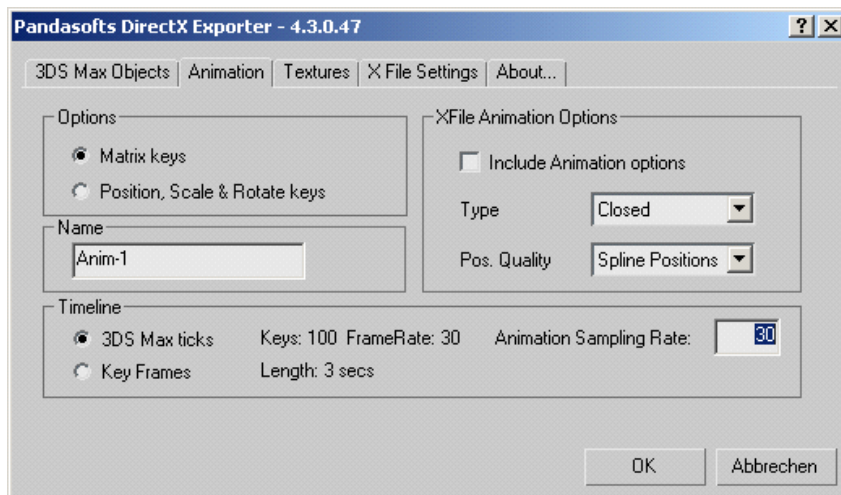
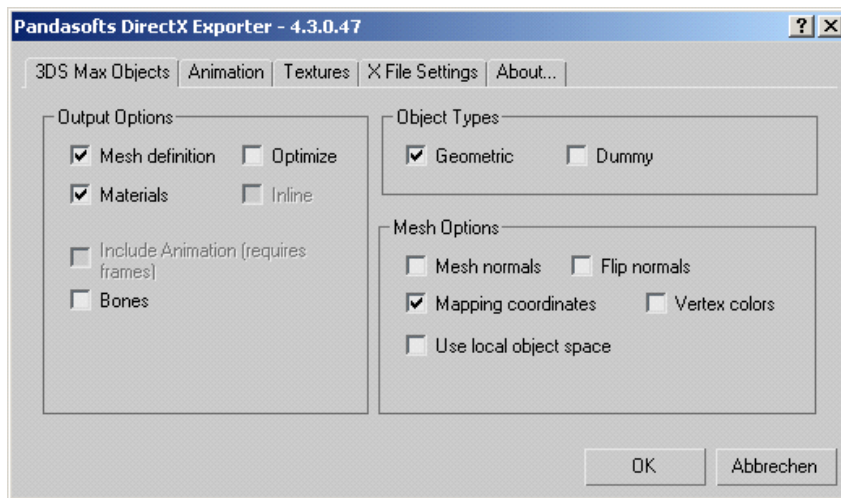

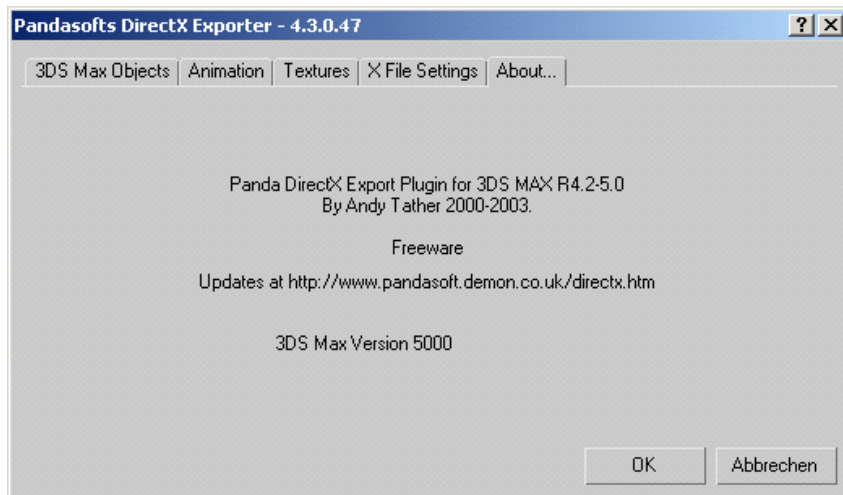
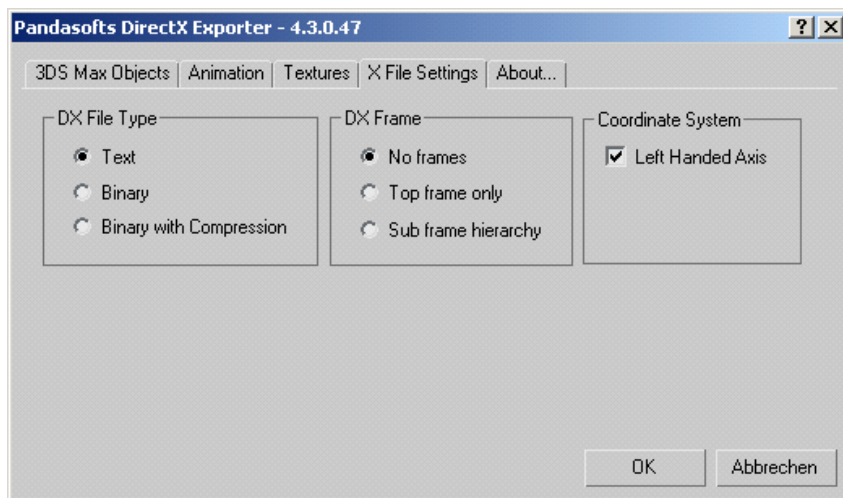
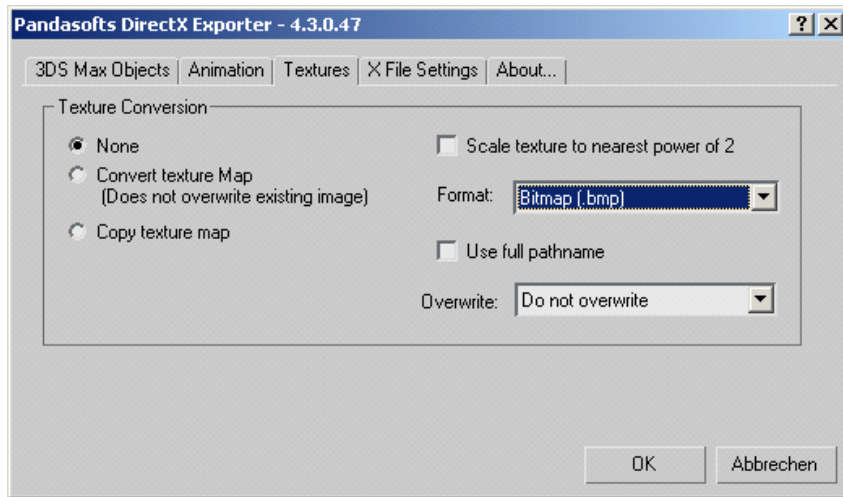

### 19.3 Blender

Please make yourself familiar with the basics described in the [introducing chapter](#)<sup>1592</sup>. You need to know them when using Blender to create objects to be used in the [Warper](#)<sup>780</sup> or in [Pandoras Box](#)<sup>94</sup>. Even more detailed information can be found in the Warper's chapter "[General 3D Modeling Terms](#)<sup>782</sup>".



To set up generic units in Blender, usually you do not have to do anything. The "None" setting matches the generic unit already. In the same dialog you may adjust the camera to match Pandoras Box' camera.

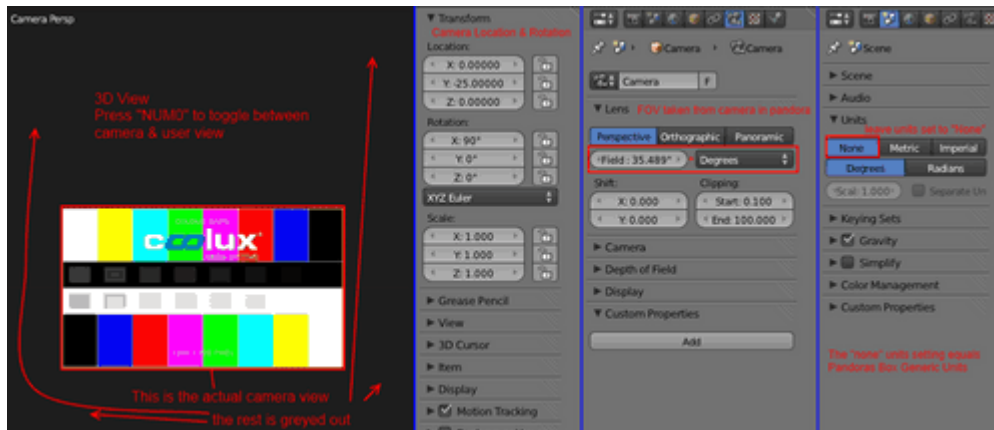

If you like to learn how to [generally create an object](#)<sup>1595</sup> and how to apply an UVW Map, please refer to the chapters in gmax.

The next chapter describes how to [create and export objects in Blender](#)<sup>1617</sup>.

### 19.3.1 Object Creation and Export Using Blender

#### Creating objects in Blender

Object creation is very similar in every 3D program, please have a look at the [gmax chapter](#)<sup>1593</sup> as well. For Blender, we suggest the following tutorials to get started with the application itself: <http://gryllus.net/Blender/3D.html>

#### Exporting from Blender to Pandoras Box

If you are done with your object and are ready to export it, first of all, go into Object Mode and press CTRL+A. Then select "Rotation & Scale". This will apply all your rotation and scaling. It might also be required to apply "Location". Now you can export either as .x or .3ds

To export directly to Pandoras Box simply choose "File->Export->Direct X(.x)". You might have to activate the plugin first (see image):

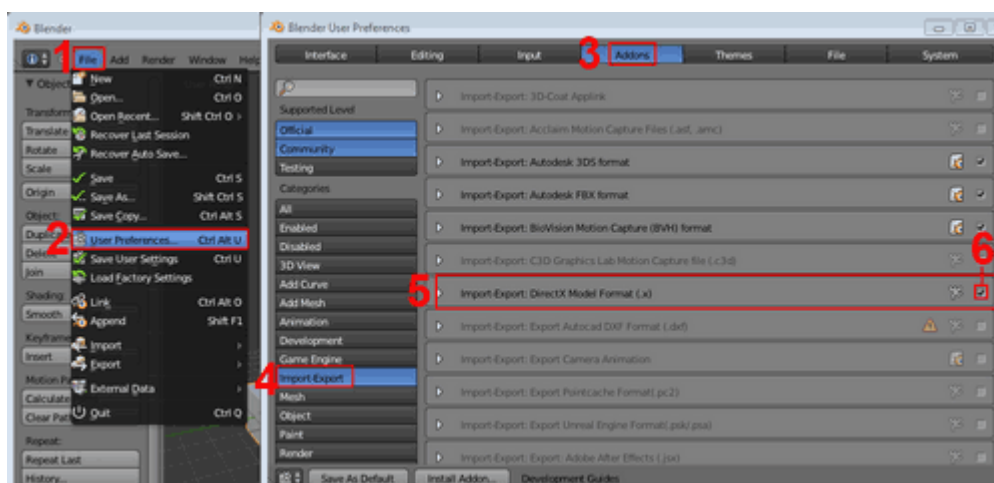

The Warper, may as well import files saved in 3ds format. Choose "File->Export->3DStudio (.3ds)" to export a \*.3ds file. Refer to the following image for the correct export settings:

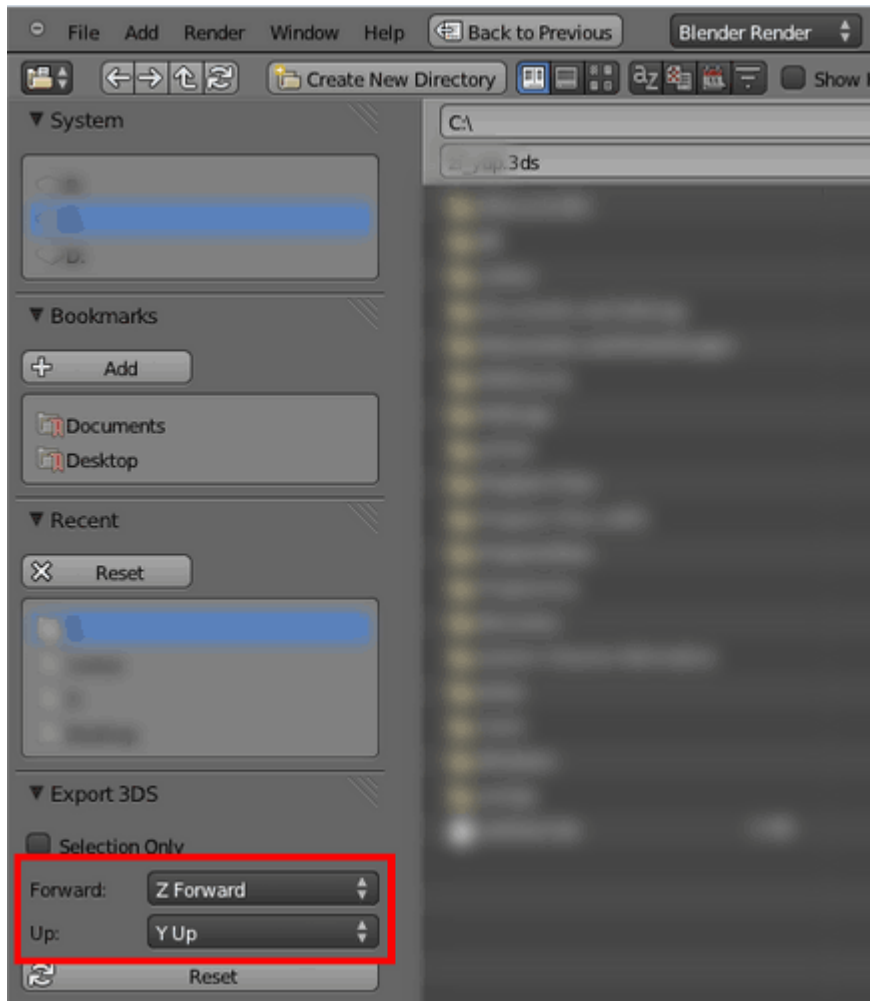

## Index

### -- 1 --

128 KEYS, Widget Designer 1207

### -- 3 --

3ds Max

Third Party Software 1614

X-File Exporter for 3ds Max 1615

### -- 5 --

58 KEYS, Widget Designer 1206

### -- 8 --

84 KEYS, Widget Designer 1206

### -- A --

ABS, Filter Node, Widget Designer 1086

ACCESSORIES 659

ACOS, Filter Node, Widget Designer 1086

ACTIVE VALUES 135

ADD LAYERS, Using Widget Designer 801, 1242

ADD RELATIVE, Filter Node, Widget Designer 1073

ADD, Filter Node, Widget Designer 1087

AEON FX 136

AIRBAR, Input Node, Widget Designer 984

AIRSCAN

CALIBRATION, Widget Designer 1158

GENERAL SETTINGS, Widget Designer 1157

HOW TO USE THE AIRSCAN?, Widget Designer 1155

Input Node, Widget Designer 985

INPUT POINT PROCESSING, Widget Designer 1157

MOUSE CONTROL, Widget Designer 1160

MULTI POINT MODE, Widget Designer 1159

POINT READ-OUT, Widget Designer 1161

TOOL SETUP, Widget Designer 1156

Widget Designer 1155

AIRSCAN MULTI-POINT, Input Node, Widget Designer 986

AKAI APC40, Widget Designer 1211

ALIGN LAYERS, Using Widget Designer

Array 1243

Circle 1244

Alpha channel in mpeg 842

ANALOG CLOCK, Widget Designer 907

ANGLE TO POINT, Filter Node, Widget Designer 1074

ANGULAR DISPLAY

Output Node, Widget Designer 1109

Widget Designer 912

ANIMATION, FX 328

ANTI-ALIASING, FX 329

ART-NET

Connection Manager, Widget Designer 1167

Input Node, Widget Designer 987

Output Node, Widget Designer 1110

ART-NET MONITOR, Widget Designer 1177

ART-NET RECORDER, Button, Widget Designer 898

ASCII, Widget Designer 970

ASIN, Filter Node, Widget Designer 1088

ASSETS 137

ATAN, Filter Node, Widget Designer 1088

ATI CARDS 685

ATTACHING FILES 192

AUDIO

Video Layer Control 303

AUDIO (BETA) , Input Node, Widget Designer 988

AUDIO FORMATS 98

AUDIO LAYER CONTROL

Introduction 578

### -- B --

BACKUP MENU 132

BAR GRAPH

Output Node, Widget Designer 1111

Widget Designer 914

BEHRINGER BCD 2000, Widget Designer 1212

BEHRINGER BCF 2000, Widget Designer 1213

BLACK BOX (BETA) , Input Node, Widget Designer 989

BLACKLEVEL COMPENSATION 613

BLACKLIST, Widget Designer 1214

Blender

object creation and export 1617

Third Party Software 1616

BLUR, FX 330

BROWSER INSPECTOR 192

BUILT-IN DMX DEVICES 607

BUTTON , Input Node, Widget Designer 991

BUTTONS, Widget Designer 883

### -- C --

CALIBRATION LINK 747

Examples 750

Hardware 747

Input Node, Widget Designer 989

Software 753

CAM WIREFRAMES, Preview Tab 238

CAMERA CONTROL

CAMERA CONTROL

- Background Color 596
- Introduction 589
- Lens Shift 594
- Projection Mode 590
- Settings 594
- Target 592
- View Point 591

CAMERA INSPECTOR 214

CAMERA POINT TRACKER

- Input Node, Widget Designer 992
- Widget Designer 1224

CAMERA PROJECTION, FX 342

CAMERA SETTINGS, Camera Point Tracker, Widget Designer 1225

CEILING, Filter Node, Widget Designer 1089

CHANGELOG, Widget Designer 1435

CHANGING PARAMETER VALUES 165

CITP DESKTOP STREAMER 856

- Capture Polar Settings 858
- Capture Settings 858
- Preview 857
- Streaming Settings 856
- User Interface 856
- WYSIWYG Settings 859

CLIENT

- Keyboard Shortcuts 295
- LIVE INPUT CONFIGURATION 295
- PB Client 294

CLIP INSPECTOR 202

CLIP SUMMARY INSPECTOR 201

CLOCK , Input Node, Widget Designer 993

COLOR EFFECTS - CROP, FX 352

COLOR EFFECTS - SOFTBORDER, FX 363

COLOR EFFECTS, FX 343

COLOR PICKER, FX Parameter 323

COLOR PROCESSING, Camera Point Tracker, Widget Designer 1226

COLOR SHIFT, FX 373

COLOUR PICKER

- Input Node, Widget Designer 993
- Widget Designer 921

COM ASCII STREAM , Input Node, Widget Designer 995

COM PORT

- Input Node, Widget Designer 994

COM PORT ASCII STREAM, Output Node, Widget Designer 1113

COM PORT MESSAGE, Output Node, Widget Designer 1112

COM QUERY STRING , Input Node, Widget Designer 996

1620

COM SCRIPTS, Widget Designer 1141

COMMAND LIST, Widget Designer 1260

COMPARE TEXT, Filter Node, Widget Designer 1100

COMPOSITING, FX 386

CONFIGURATION, PB Tab 139

- ASIO Audio 156
- Cache 159
- Devices / Parameters 139
- Extensions 157
- Local Preview 153
- Network 146
- Preview Display 151
- Remote Control Protocols 146
- Render Engine 153
- Resources 141
- Sequence 144
- SMPTE Link Timecode 157
- Startup 149
- Unit Management 149
- Web Server 158

Conformity 17

CONNECTION MANAGER, Widget Designer 1166

CONTAINS TEXT, Filter Node, Widget Designer 1101

CONTENT

- Audio Formats 98
- Defining Content Resolution 95
- Display and Content Formats 94
- Image Formats 98
- Image Sequence Formats 99
- Introduction 94
- Output Resolution Table 96
- Video Formats 102

CONTEXT MENU, Device Tree 172

CONTROLLER BOARDS 708

CONTROLLER SETUP, Tab, PB 159

CONTROLS, Widget Designer 879

COS, Filter Node, Widget Designer 1089

COUNT DOWN , Input Node, Widget Designer 997

COUNTER , Input Node, Widget Designer 998

CREATING AND SETTING UP NODES, Widget Designer 964

CROPPING, FX 391

CUE CONTROL, Button, Widget Designer 890

CUE GENERATOR, Using Widget Designer 1245

CUE INSPECTOR 204

CUE LIST, Widget Designer 908

CURVE EDITOR 161

CUSTOM DMX DEVICES 608  
 CUSTOM SCRIPT BUTTON, Widget Designer  
 884

**-- D --**

DAMPING PREDICTION, Filter Node, Widget  
 Designer 1075  
 DAMPING TIMED, Filter Node, Widget Designer  
 1076  
 DATAPATH VISION RGB PRO (VGA) -  
 discontinued 693  
 DATE TO TEXT, Filter Node, Widget Designer  
 1102  
 DEC, Widget Designer 970  
 DECKLINK SD SDI VIDEO CAPTURE CARD  
 703  
 DEFAULT IMAGE SETTINGS, Widget Designer  
 1248  
 DEGREE > RADIANS, Filter Node, Widget  
 Designer 1090  
 DELTA, Filter Node, Widget Designer 1077  
 DEVICE CONTROL 296  
 Tab 164  
 DEVICE INSPECTOR 206  
 DEVICE SELECTION, Device Tree 176  
 DEVICE SETTINGS, Multitouch, Widget Designer  
 941  
 DEVICE TREE 168  
 DEVICE TYPES 181  
 Audio Track 578  
 Camera 589  
 DMX Devices 607  
 Graphic Layer 577  
 Light Layer 582  
 Output 597  
 Pointer Layer 581  
 Serial Link Device 608  
 Sonic Emotion 609  
 Video Layer 298  
 Widget Designer Device 609  
 DEVICE VIEWER 182  
 DIGITAL CLOCK , Widget Designer 911  
 DIGITAL DISPLAY  
 Output Node, Widget Designer 1114  
 Widget Designer 915  
 DISPLAYS , Widget Designer 912  
 DISTORT, FX 403  
 DIVIDE, Filter Node, Widget Designer 1090  
 DMX Addressing 762  
 DMX DEVICES  
 Introduction 607  
 DMX INPUT, Input Protocol 621

DMX LINK 735  
 DMX LINK 8 736  
 DMX LINK IN, Input Node, Widget Designer 999  
 DMX LINK OUT, Output Node, Widget Designer  
 1114  
 DMX OUTPUT, Output Protocol 642  
 DMX SHEET  
 Overview 623  
 PB Manager 623  
 PB Player 632  
 PB Server 624  
 Sequence Control 623  
 DMX START ADDRESS 228  
 DMX TABLE  
 Overview 623  
 PB Manager 623  
 PB Player 632  
 PB Server 624  
 Sequence Control 623  
 DMX-LINK, Connection Manager, Widget Designer  
 1168  
 DOME MASTER 832  
 File 834  
 Image 834  
 Settings 837  
 User Interface 833  
 What is...? 833

DRAWING CANVAS, Widget Designer 935  
 DROP DOWN LIST, Widget Designer 918  
 DROPDOWNLIST , Input Node, Widget Designer  
 999  
 DUAL DVI CAPTURE CARD 707  
 DVI PROCESSOR  
 Create a new Timing 672  
 Hardware 663  
 Software 664  
 DVI Processor, QUAD Setup Menu 662  
 DYNAMIC TRIGGER, Filter Node, Widget  
 Designer 1078

**-- E --**

EDID LINK 741  
 Hardware 742  
 Software 744  
 EDIT MENU, PB 130  
 EFFECTS  
 Graphic Layer Control 319  
 PB Tab 136  
 Video Layer Control 319  
 Electrical Information 17  
 EMAIL SETTINGS, Widget Designer 1214  
 EMAIL, Input Node, Widget Designer 1000

## ENCODER

Input Node, Widget Designer 1001  
Widget Designer 922

## ENCODING

Encoder Extension 104  
Encoder Extension Tab 182  
Mainconcept (up to Version 4.5) 109  
Overview 103

EVENT VIEWER, Widget Designer 920

## EVENTS

Input Node, Widget Designer 1001  
Widget Designer 1188

EXCEL READER , Input Node, Widget Designer 1002

EXCEL WRITER, Output Node, Widget Designer 1115

EXPAND &amp; COLLAPSE PARAMETER SECTIONS 167

EXTERNAL CONTROL 621

**-- F --**

FACE TRACKER, Widget Designer 1222

FACE TRACKING , Input Node, Widget Designer 1003

FACTORY RESET TOOL 657

## FADER

CONTROLS, Widget Designer 921  
Input Node, Widget Designer 1003  
Output Node, Widget Designer 1116  
Widget Designer 925

FADER CONTROLLER, Tab, PB 159

FADER EXTENSION 710

## FILE INSPECTOR

Options in the tab 190  
The Attach function 192

## FILE MENU

Pandoras Box 129

FILTER NODES, Widget Designer 1070

FIREFLY PARTICLES 182

FLIPSWITCH, Button, Widget Designer 904

FLOOR, Filter Node, Widget Designer 1091

FOLDER INSPECTOR 198

FOR LOOP, Widget Designer 1434

FRACTALS, FX 415

## FUNCTIONS

Widget Designer 1189

FX 136

Adding FX 319  
Copy / Paste FX 324  
FX List 328  
FX Order 321  
FX Parameter 323

Graphic Layer Control 319

Output Control 607

Removing FX 328

Video Layer Control 319

FX COLLECTIONS, FX 416

**-- G --**

GENERATOR, FX 417

GEOMETRY, FX 419

GIZMO 239

GIZMO, Preview Tab 238

GLOBAL CAM 234

## gmax

advanced steps 1606  
general object creation in gmax 1595  
Keyboard Shortcuts 1614  
object creation and export 1594  
Software Setup 1593  
Third Party Software 1593  
warping with gmax 1606

GPS , Input Node, Widget Designer 1004

GRADIENTS, FX 423

GRAPHIC LAYER CONTROL 577

GRAPHIC SETTINGS 675

GROUP VIEW 187

**-- H --**

HARDWARE 659

HD SDI CAPTURE CARD 705

HEX, Widget Designer 970

HTTP LISTENER, Widget Designer 1183

**-- I --**

ID TAG TRACKER, Input Node, Widget Designer 1005

IF ELSE, Widget Designer 1430

IF, Filter Node, Widget Designer 1079

IMAGE / PICTURE BOX, Widget Designer 930

IMAGE ADJUST - CROP, FX 445

IMAGE ADJUST - IRIS, FX 452

IMAGE ADJUST - MEDIAMASK, FX 460

IMAGE ADJUST - SOFTBORDER, FX 466

IMAGE ADJUST, FX 434

## IMAGE CONVERTER

File 839  
Image 840  
Overview 838  
Settings 843  
User Interface 839

IMAGE FORMATS 98

IMAGE LOADER, Button, Widget Designer 891

- IMAGE PROCESSING, Camera Point Tracker, Widget Designer 1226
- IMAGE RESOURCE MANAGER, Widget Designer 1249
- IMAGE SEQUENCE FORMATS 99
- IMAGE SEQUENCE INSPECTOR 194
- INPOINT / OUTPOINT 580
- INPUT / OUTPUT CONTROL 621
- INPUT CARD SETTINGS 692
- INPUT NODES, Widget Designer 980
- INPUT PROTOCOLS 621
- INSPECTOR 188
- INSTALLATION  
Widget Designer 865
- INTERACTION NODES, Widget Designer 1146
- INTERFACE KIT 0/16/16, Phidgets, Widget Designer 1232
- IP CONFIGURATION (NETWORK SETUP), Widget Designer 865
- IPHONE REMOTE , Input Node, Widget Designer 1030
- IPHONE WD REMOTE, Widget Designer 1185
- IR – RECEIVER TRANSMITTER, Phidgets, Widget Designer 1233
- IR ID Tracking 1005
- J--**
- JITTER REDUCE, Filter Node, Widget Designer 1080
- JOG SHUTTLE  
CONTROL 709  
Tab, PB 159  
Widget Designer 1205
- JOYSTICK , Input Node, Widget Designer 1031
- K--**
- KEYBOARD INPUT, Widget Designer 1203
- KEYBOARD SHORTCUTS  
gmax 1614  
PB Client 295  
PB Master 292  
Warper 831  
Widget Designer 878
- KEYING, FX 472
- KEYSTONE  
Output 603
- KINECT  
Input Node, Widget Designer 1032  
Widget Designer 1162
- KINESYS , Input Node, Widget Designer 1032
- L--**
- LABEL  
1623
- Input Node, Widget Designer 1034
- Output Node, Widget Designer 1116
- Widget Designer 931
- LAYER INSPECTOR 208
- LAYER PICKING 244
- LAYER UV DRAW TO CANVAS, Interaction Node, Widget Designer 1150
- LCD MENU 659
- LEADING ZEROS, Filter Node, Widget Designer 1103
- LIGHT LAYER CONTROL  
Color 586  
Intensity 584  
Introduction 582  
Media 583  
Playback 584  
Position 584  
Settings 587  
Target 585
- LIGHT LAYER INSPECTOR 211
- LIGHT WIREFRAMES, Preview Tab 238
- LIGHT, FX 484
- LIGHTING - TEXTURE PROJECTION, FX 493
- LINKING PARAMETERS 165
- LIVE INPUT  
CITP Desktop Streamer 856  
Configuration in PB Client 295  
Input Cards 692  
Settings for StreamiX Desktop 655  
Video Recording Tab 284
- LIVE INPUTS  
PB Asset Tab 137
- LOCK INTERFACE, Widget Designer 1251
- LOG, Filter Node, Widget Designer 1092
- LOGITECH PRESENTER R400, Widget Designer 1208
- M--**
- MACRO, Widget Designer 1191
- MAIN GUI PROPERTIES, Widget Designer 870
- MASKING, FX 500
- MATH FILTER NODES, Filter Node, Widget Designer 1086
- MATRIX PATCHER  
Edit Menu 759  
File Menu 758  
File Menu, Fixture Editor 764  
Fixture Channel ID, Fixture Editor 766  
Fixture Editor 764  
Fixture Library 760  
Fixture Library, Fixture Editor 765  
Fixture Navigation Tools 761

**MATRIX PATCHER**

- Fixture Patch 761
- Fixture Workspace, Fixture Editor 767
- Hox to create and edit Fixtures 768
- Overview 757
- Patch Settings 763
- Patching Guide 770
- Remapping Guide 776
- Toolbar 759
- User Interface 757

**MAX, Filter Node, Widget Designer 1081**

**MEDIA**

- PB Manager 578

**MEDIA CONTROL PANEL, Button, Widget Designer 889**

**MEDIA CONTROL , Input Node, Widget Designer 1034**

**Media Dongle, Media Encryption 217**

**MEDIA ENCRYPTION**

- Decryption 221
- Encryption 218
- General Information 216
- Policy Update 222

**MEMBER VALUES, Widget Designer 1196**

**MENU BAR, PB 129**

**MIDI IN- & OUTPUT, Connection Manager, Widget Designer 1168**

**MIDI IN , Input Node, Widget Designer 1035**

**MIDI INPUT, Widget Designer 1208**

**MIDI MESSAGE EDITOR, Widget Designer 1210**

**MIDI NOTE CATCH, Input Node, Widget Designer 1036**

**MIDI NOTE ON/OFF, Output Node, Widget Designer 1117**

**MIDI NOTES EDITOR, Widget Designer 1209**

**MIDI RAW MESSAGE, Output Node, Widget Designer 1118**

**MIDI VALUE, Output Node, Widget Designer 1119**

**MIDI, Input Protocol 637**

**MIN, Filter Node, Widget Designer 1082**

**MIRROR, FX 507**

**MODULO, Filter Node, Widget Designer 1092**

**MOTION DETECTOR**

- Input Node, Widget Designer 1037
- Widget Designer 1223

**MOTION MASK, Widget Designer 916**

**MOUSE**

- Input Node, Widget Designer 1038
- Output Node, Widget Designer 1120

**MOUSE DRAW TO CANVAS, Interaction Node, Widget Designer 1148**

**MOUSE INJECTION, Interaction Node, Widget Designer 1148**

**MSC MIDI SHOW CONTROL, Input Protocol 637**

**MULTIPLY, Filter Node, Widget Designer 1093**

**MULTITOUCH PANEL**

- PROPERTIES, Widget Designer 937
- Widget Designer 936

**MULTI-TOUCH PANEL**

- ITEM , Input Node, Widget Designer 1039
- POINT , Input Node, Widget Designer 1040

**-- N --**

**NET LINK 747**

- Hardware 747
- Input Node, Widget Designer 1040
- Software 753

**NETWORK**

- Configuration, PB 146

**NETWORK & SYNCHRONIZATION 646**

- Master / Client Remote Setup 647
- Network Setup 646
- Video Synchronisation 648

**NETWORK BROADCASTING SERVICE, Widget Designer 1184**

**Network performance 762**

**NODES, Widget Designer 959**

**NVIDIA CARDS**

- Changing the resolution 675
- Graphics Driver 682
- Setting up multiple displays 677
- Setting up the frame lock option 678

**-- O --****OBJECT CREATION**

- Blender, Third Party Software 1617
- gmax, Third Party Software 1594

**OBJECT INSPECTOR 195**

**ODSL 30, Input Node, Widget Designer 1043**

**ONSCREEN MENU 754**

**OPACITY**

- Video Layer Control 301

**OPTIONS, Widget Designer 1252**

**OSC, Input Node, Widget Designer 1044**

**OUTPUT CONTROL**

- Background Color 602
- FX 607
- Introduction 597
- Keystone 603
- Lens Shift 602



## OUTPUT CONTROL

Matrix 598  
 Object 599  
 Render State 606  
 Settings 601  
 Softedge 604  
 Target 601  
 View Point 600

OUTPUT INSPECTOR 215

OUTPUT NODES, Widget Designer 1106

OUTPUT PROTOCOLS 642

OUTPUT RESOLUTION TABLE 96

OUTPUT SETTINGS 675

OVERLAY, FX 508

**--P--**

## PAGE

Input Node, Widget Designer 1045  
 Output Node, Widget Designer 1121  
 Page Browser, WD 881  
 Widget Designer 880

PAN, Audio, PB Manager 580

PANEL SETTINGS, Multitouch, Widget Designer 937

PANEL, Widget Designer 934

PARAMETER KEYFRAME INSPECTOR 203

PARAMETER LIST 1256

PARAMETER NAMES, Pandoras Box 1256

PARAMETER SECTIONS 167

PARAMETER VALUE RANGES 164

PARAMETER VALUE READOUT 164

PARAMETER VALUES 165

PARTICLES 182

PATCH 222

## PATCH DMX

Overview 623  
 PB Manager 623  
 PB Player 632  
 PB Server 624  
 Sequence Control 623

PATTERN, FX 520

PB Automation 1532

PB DEVICE CONTROL, Output Node, Widget Designer 1122

PB DEVICE PARAMETER INPUT, Input Node, Widget Designer 1045

PB MENU 754

PB SEQUENCE CONTROL, Output Node, Widget Designer 1123

PB SEQUENCE SEEK, Output Node, Widget Designer 1124

PB SETTINGS, Multitouch, Widget Designer 945

PB TEXT UNICODE, Output Node, Widget Designer 1126

PB TEXT, Output Node, Widget Designer 1125

PERCENT, Filter Node, Widget Designer 1094

## PHIDGETS

IR SCRIPTS, Widget Designer 1144  
 Overview, Widget Designer 1231  
 RFID SCRIPTS, Widget Designer 1145

PING, Input Node, Widget Designer 1046

PIVOT HANDLES 239

PIVOT POINT, Preview Tab 238

## PLAYBACK

DMX Control 579

PLAYBACK EXTENSION 712

PLAYLIST INSPECTOR 196

PLAYLIST TAB 229

POINT TRACKER, Camera Point Tracker, Widget Designer 1228

POINTER INSPECTOR 210

## POINTER LAYER CONTROL

Introduction 581

POLAR &gt; RECTANGULAR, Filter Node, Widget Designer 1083

## POSITION

Video Layer Control 304

POWER X\*Y, Filter Node, Widget Designer 1094

PRESET VIEW 230

## PREVIEW 232

CONTENT AS INTERFACE 244  
 GIZMO 238  
 GLOBAL CAM 234  
 HANDLES 238  
 INCLUDING SITES INTO THE PREVIEW 233  
 INTERACTIVE PREVIEW 239, 244  
 LAYER PICKING 244  
 NAVIGATION 237  
 OUTPUT VIEW 234  
 PATCH VIEW 234  
 USING PIVOT HANDLES 239  
 WIREFRAMES 238

PRODUCT OVERVIEW 65

PRODUCT STRUCTURE 65

PROGRAMMING STATEMENTS, Widget Designer 1430

## PROJECT TAB

Groups 251  
 Introduction 248  
 Media Files 248  
 Presets 253

PROJECT TAB

- Sequences 251
- Tabs 258
- Views 257

PROJECTOR CONTROL , Input Node, Widget Designer 1046

PSN MA TRACKING SERVER, Connection Manager, Widget Designer 1169

**-- R --**

RADIANS>DEGREE, Filter Node, Widget Designer 1095

RANDOM , Input Node, Widget Designer 1048

RANGE ASYMMETRIC, Filter Node, Widget Designer 1085

RANGE, Filter Node, Widget Designer 1084

REGEX COMPARE, Filter Node, Widget Designer 1105

REGEX TEXT, Filter Node, Widget Designer 1103

RELAY INTERFACE 0/4/4, Phidgets, Widget Designer 1234

RELAY OUTPUT LINK  
Output Node, Widget Designer 1126

REMAP, FX 525

REMOTE TOUCH, Input Node, Widget Designer 1049

REMOTING, Widget Designer 1182

RFID, Phidgets, Widget Designer 1234

ROTATION  
Video Layer Control 306

ROUND, Filter Node, Widget Designer 1096

RSS  
Input Node, Widget Designer 1050  
SETTINGS, Widget Designer 1217

**-- S --**

SCALE  
Video Layer Control 309

SCRIPT  
Output Node, Widget Designer 1129  
Overview , Widget Designer 1254  
TIMER, Button, Widget Designer 888

SCRIPT LIST, Widget Designer 1260

SCRIPT NODES, Widget Designer 1140

SCROLLER, Button, Widget Designer 901

SD SDI CAPTURE CARD 704

SD SDI VIDEO CAPTURE CARD, DECKLINK 703

SDI PROCESSOR  
Hardware 663  
Software 664

SDI Processor, QUAD Setup Menu 662  
1626

SDK 1532

- Datatypes and Structures 1545
- Examples for connecting, sending and receiving values 1541
- Function Reference 1548
- Getting Started 1534
- Other Languages 1537
- Using JavaScript 1535
- Using Visual Basic and C# 1535

SECURITY SETTINGS, Widget Designer 1250

SELECT CASE, Widget Designer 1432

SENSOR LINK 716  
Analog Inputs 718  
Configuration Tool and Widget Designer 721  
Connecting 718  
Encoder Inputs 719  
Input Node, Widget Designer 1051  
Stand-Alone Software 723  
Technical Features 717  
User Interface 720

SENSOR LINK, SWITCH INPUTS S1-S8 718

SEQUENCE  
Commands 262  
Configuration tab, PB 144  
Control 261  
Introduction 260  
Overview 261  
Programming 264  
Tracking 269

SEQUENCE CONTROL 273

SEQUENCE INSPECTOR 200

SEQUENCE LOGGER, Using Widget Designer 1246

SEQUENCE PATCH 228

SERIAL COM CONNECTIONS  
Connection Manager, Widget Designer 1174

SERIAL INPUT, Widget Designer 1187

SERIAL LINK 729  
GPI, Input Node, Widget Designer 1053  
Input Protocol 640  
Output Node, Widget Designer 1131  
Output Protocol 643

SERIAL LINK DEVICE 608

SERVO MOTOR ADVANCED 8, Phidgets, Widget Designer 1235

SESSION VALUES, Widget Designer 1196

SETUP, Widget Designer 865

SHADOWS, FX 527

SHAPES, FX 527

SHARPEN, FX 544

SHORTCUT EDITOR, Widget Designer 1204

SHORTCUTS

SHORTCUTS

gmax 1614  
 PB Client 295  
 PB Master 292  
 Warper 831  
 Widget Designer 878

SIN, Filter Node, Widget Designer 1096

SITE PATCH 223

SMPTE LINK 735

Connection Manager, Widget Designer 1166  
 Input Node, Widget Designer 1055  
 INPUT, Input Protocol 640  
 OUTPUT, Output Protocol 644  
 TIMECODE, Configuration, PB 157

SMS

Input Node, Widget Designer 1054  
 SETTINGS, Widget Designer 1219

SNAPSHOT, Button, Widget Designer 896

SNAPSHOT, FX 547

SOFTEDGE

FX 548  
 Output 604

SOFTEDGE - SOFTEDGE P-CURVE ALPHA, FX 550

SOFTEDGE - SOFTEDGE P-CURVE GAMMA, FX 552

Software Development Kit 1532

SONIC EMOTION 609

SPACE NAVIGATOR, Input Node, Widget Designer 1055

SPARK

Output Protocol 643  
 Overview 614  
 SPLITTER 848  
 Edit Menu 851  
 File Menu 850  
 Main Window 853  
 Toolbar 851  
 User Interface 849  
 Workflow 854

SQRT, Filter Node, Widget Designer 1097

STARTUP DIALOG, PB 127

STREAMIX DESKTOP 650

Desktop Region 652  
 General Information 654  
 Live Input Settings 655  
 Network Connection 652  
 Output Format 653  
 Transmission 654  
 User Interface 651

STROBE, FX 553

STYLIZE, FX 555  
 1627

SUBTRACT, Filter Node, Widget Designer 1098

SUM, Filter Node, Widget Designer 1098

SYNTAX TCP- / UDP- / SERIAL MESSAGES, Widget Designer 970

--T--

TAB BUTTON INSPECTOR 199

TABS MENU, PB 131

TABS OVERVIEW 134

TAN, Filter Node, Widget Designer 1099

TASKMANAGER 275

TCP

Input Node, Widget Designer 1059  
 SCRIPTS, Widget Designer 1142  
 TCP SERVER, Remoting, Widget Designer 1183

TCP ASCII STREAM

Input Node, Widget Designer 1060  
 Output Node, Widget Designer 1134

TCP CONNECTIONS

Connection Manager, Widget Designer 1170

TCP MESSAGE, Output Node, Widget Designer 1133

TCP QUERY STRING, Input Node, Widget Designer 1061

TCP/IP

Input Protocol 641  
 Output Protocol 644

TCP/UDP/COM CONNECTIONS, Widget Designer 1176

TEXT COMBINER, Filter Node, Widget Designer 1106

TEXT FILTER NODES, Widget Designer 1100

TEXT INPUT EDITOR 277

TEXT INPUT, Widget Designer 951

TEXT INSPECTOR 197

TEXT READER, Input Node, Widget Designer 1057

TEXTBOX

Input Node, Widget Designer 1056  
 Output Node, Widget Designer 1135  
 Widget Designer 953

Third Party Software

3ds Max 1614  
 Blender 1616  
 gmax 1593  
 Introduction 1592

THUMBNAIL VIEWER 280

TIMAX, Input Node, Widget Designer 1058

TIMECODE, Widget Designer 955

Toggle Key Mode 268

TOOLS MENU

Pandoras Box 132

- TOOLS, Widget Designer 1154
- TOUCH INJECTION, Interaction Node, Widget Designer 1147
- TOUCH OUTPUT PROCESSING, Camera Point Tracker, Widget Designer 1229
- TRACK INSPECTOR 213
- Tracking
- Camera Tracking 992
  - Face Tracking 1003
  - ID Tags 1005
  - Motion 1037
  - TrackScan 1063
  - with lighting console 1028
- TRACKSCAN SERIAL LINK, Input Node, Widget Designer 1064
- TRACKSCAN, Input Node, Widget Designer 1063
- Tranparent information in mpeg 842
- TRANSITION, FX 558
- TUIO TRANSMITTER, Connection Manager, Widget Designer 1169
- TUTORIAL NODES, Widget Designer 967
- U--**
- UDP
- Input Node, Widget Designer 1065
  - LISTENER, Remoting, Widget Designer 1183
  - MESSAGE, Output Node, Widget Designer 1136
  - PB AUTOMATION, Input Protocol 641
  - SCRIPTS , Widget Designer 1143
- UDP ASCII STREAM
- Input Node, Widget Designer 1066
  - Output Node, Widget Designer 1137
- UDP CONNECTIONS
- Connection Manager, Widget Designer 1172
- USER INTERFACE
- CITP Desktop Streamer 856
  - Dome Master 833
  - Image Converter 839
  - Layout 290
  - Matrix Patcher 757
  - Menu Bar in PB 129
  - Pandoras Box 126
  - Sensor Link 720
  - Splitter 849
  - Startup Dialog in PB 127
  - StreamiX Desktop 651
  - Tabs Overview 134
  - Warper 788
  - Widget Designer 869
- USER INTERFACE, Tabs
- Active Values 135
- Aeon FX 136
  - Assets 137
  - Configuration 139
  - Controller Setup 159, 161
  - Device Control 164
  - Device Tree 168
  - Device Types 181
  - Device View er 182
  - Encoder Extension 182
  - FireFly Particles 182
  - Group View 187
  - Inspector 188
  - Patch 222
  - Playlist 229
  - Presets 230
  - Preview 232
  - Project 248
  - Sequence 260
  - Sequence Control 273
  - Taskmanager 275
  - Text Input Editor 277
  - Thumbnail View er 280
  - Video Export 281
  - Video Recording 284
  - View Tab 286
  - Virtual Site 286
- UV MAPPING, FX 565
- V--**
- V5 VIDEO PROCESSING PIPELINE 297
- VALUE
- Input Node, Widget Designer 1067
  - Output Node, Widget Designer 1138
- VARIABLE
- Input Node, Widget Designer 1068
  - Output Node, Widget Designer 1138
  - VARIABLE LIST, Widget Designer 1193
- VIDEO EXPORT 281
- VIDEO FORMATS 102
- VIDEO INPUT DISPLAY, Widget Designer 918
- VIDEO LAYER CONTROL
- Audio 303
  - Blend Mode 315
  - Effects 319
  - FX 319
  - Introduction 298
  - Meda / Mesh 299
  - Opacity 301
  - Playback 302
  - Position 304
  - Rotation 306
  - Rotation Pivot 311

VIDEO LAYER CONTROL	
Scale	309
Scale Pivot	313
VIDEO LOGGER, Using Widget Designer	1246
VIDEO PLAYER TIME, Output Node, Widget Designer	1139
VIDEO PLAYER VOLUME , Output Node, Widget Designer	1140
VIDEO PLAYER, Widget Designer	956
VIDEO RECORDING	284
VIDEO SNAPSHOT, Button, Widget Designer	893
VIEW TAB	286
VIRTUAL SITE	286
VNC PANEL, Widget Designer	957
VNC REMOTE	860
VOLUME	579
<b>-- W --</b>	
WARP, FX	576
WARPER	828
3D Modeling Terms	782
Camera / View tab	813
Cameras	801
Dynamic Warping	828
Edit Menu	794
File Menu	789
General tab	805
Keyboard / Mouse tab	812
Keyboard Shortcuts	831
Live Warp	828
Live Warp tab	819
Marker tab	815
Mask tab	810
Menu Bar	789
Mesh tab	807
Meshes	801
Overview	780
PB Camera tab	813
Tabs	804
Texture tab	808
Tools Bar	802
User Interface	788
Using an Object in PB	824
Warping Guide	821
Warping with several meshes	825
Workflow	821
WD REMOTE TOUCH IN- & OUTPUT, Connection Manager, Widget Designer	1169
WEB SERVER	
Pandoras Box	158
Widget Designer	1177
WEBBROWSER, Widget Designer	958
WHAT'S NEW	21
WHEEL	
Input Node, Widget Designer	1068
Widget Designer	928
WIDGET DESIGNER	864
Changelog	1435
Command List	1260
Controls	879
Create	877
Edit	873
File	872
Installation	865
IP Configuration	865
Keyboard Shortcuts	878
Member Values	1196
Network Setup	865
Nodes	877, 959
Pages	876
Programming Statements	1430
Script Language	1254
Session Values	1196
Setup	865
Tools	1154
User Interface	869
View	875
WIDGET DESIGNER DEVICE	609
WII, Input Node, Widget Designer	1069
WINNOV VIDEUM 4400 VO / XPRESS (Composite)	695
<b>-- X --</b>	
XY PANEL	
Input Node, Widget Designer	1070
Widget Designer	948