The top half of the page features a complex, abstract background of overlapping, semi-transparent blue triangles and polygons in various shades of blue, creating a dynamic, crystalline effect. This pattern tapers off towards the bottom left, meeting a white background.

User Guide
020-001134-17

Mystique

CHRISTIE®

NOTICES and SOFTWARE LICENSING AGREEMENT

Copyright and Trademarks

Copyright © 2024 Christie Digital Systems USA Inc. All rights reserved.

All brand names and product names are trademarks, registered trademarks or trade names of their respective holders.

General

Every effort has been made to ensure accuracy, however in some cases changes in the products or availability could occur which may not be reflected in this document. Christie reserves the right to make changes to specifications at any time without notice. Performance specifications are typical, but may vary depending on conditions beyond Christie's control such as maintenance of the product in proper working conditions. Performance specifications are based on information available at the time of printing. Christie makes no warranty of any kind with regard to this material, including, but not limited to, implied warranties of fitness for a particular purpose. Christie will not be liable for errors contained herein or for incidental or consequential damages in connection with the performance or use of this material. Our centers of excellence for manufacturing in Kitchener, Ontario, Canada and in Shenzhen, China are ISO 9001:2015 Quality Management System-certified.

Christie is committed to making our documents free from language bias; however, we are not responsible for the language used on any linked or third-party documentation.

For the most current technical documentation and office contact information, visit <https://www.christiedigital.com/>.

SOFTWARE LICENSING AGREEMENT

Agreement

- a. This Software License Agreement (the "Agreement") is a legal agreement between the end user, either an individual or business entity, ("Licensee") and Christie Digital Systems USA, Inc. ("Christie") for the software known commercially as Christie® Mystique that accompanies this Agreement and/or is installed in the server that Licensee has purchased along with related software components, which may include associated media, printed materials and online or electronic documentation (all such software and materials are referred to herein, collectively, as "Software"). If Licensee does not accept the terms of this Agreement, Licensee will return the Software to Christie in accordance with Christie's standard return policy in place from time to time. BY DOWNLOADING, INSTALLING, ACTIVATING OR USING THE SOFTWARE, THE LICENSEE IS AGREEING TO BE BOUND BY THE TERMS OF THIS AGREEMENT.
- b. The Software contains third party software programs which require notices and/or additional terms and conditions. Such required third party notices and/or additional terms and conditions are located in the Mystique application (**Help > About**). By accepting this Agreement and using the Software, you are also accepting any such additional terms and conditions applicable to the third party software programs. To the extent any license for third party software programs requires an offer to provide source code for those third party software programs, this Agreement constitutes such an offer. You may request more information or a copy of such source code by contacting Christie at open.source@christiedigital.com. In conjunction with such request, provide the Christie Product Number, the Software version and the Product Serial Number (if applicable). If applicable, a nominal cost to cover shipping and media charges will be charged.

License and Restrictions

- a. **Ownership of Software:** Christie retains title and ownership of all rights, including copyright and all other intellectual property rights, in and to the Software and all copies thereof, regardless of form or media. This license is not a sale of any rights in or to the Software or any copy thereof. Licensee acquires no right whatsoever to the Software except the right to use the Software in accordance with the terms of this License.
- b. **Grant of License:** Christie grants to Licensee a single license providing a nonexclusive and non-transferable right to use, for personal or internal business purposes, the executable version of the Software, as long as Licensee complies with the terms and conditions of this License. Christie reserves all rights not expressly granted to Licensee.
- c. **Copy Restrictions:** Where the Software is provided for download onto a personal computer or similar device, Licensee may make as many copies of the Software as is reasonably required for Licensee's own use with the Device. Licensee may also make a backup copy of the Software which may be used only for reinstallation of the Software. Where the software is pre-installed on a server, Licensee may keep one copy of the Software solely for backup or archival purposes. Unauthorized copying or distribution of the Software is expressly prohibited unless agreed to in writing by Christie. Licensee must reproduce and include the copyright notice on any backup copy of the Software. Licensee may not remove or alter any proprietary rights or copyright notice or identification which indicates the ownership of the Software.
- d. **Use Restrictions:** Licensee will not (a) modify, adapt, decompile, disassemble, reverse engineer, or otherwise attempt to derive the source code for the Software, or create derivative works based on the Software; (b) assign this Agreement or redistribute, encumber, sell, transfer, lease, or grant a sublicense of the Software or the license granted herein or otherwise transfer rights to the Software to any person or entity except as and when expressly permitted by this Agreement; (c) directly or indirectly, export or transmit the Software, either alone or bundled with other software, to any country to which such export or transmission is restricted by any applicable laws without the appropriate prior written consent of the applicable government entity or department; and (d) publish or otherwise disclose the Software for others to copy. Licensee will make reasonable efforts to prevent any unauthorized use of the Software by third parties and will advise Licensee's employees of the restrictions upon use restrictions herein.
- e. **Upgrades and Updates:** While Christie is not required to do so, Christie may provide Licensee with upgrades or updates to the Software, including but not limited to files that are delivered to Licensee via online transmission or otherwise to "patch" or otherwise modify or enhance the software program. This Agreement covers any upgrades or updates to the Software that Licensee may obtain from Christie or one of its authorized vendors, unless the upgrade or update comes with its own license agreement. If Licensee decides not to download or install an upgrade or update provided by Christie, Licensee understands that this could put the Software at risk to serious security threats or cause the Software to be come unstable. Christie may, at its option, cause an upgrade or update to apply automatically.

Maintenance and Support

- a. Christie may, in its sole discretion and without any obligation, provide maintenance and support services related to the Software ("Support Services"). Support Services are governed by Christie's policies and programs described in materials available from Christie. Any supplemental software code provided to Licensee as part of the Support Services will be considered part of the Software and subject to the terms and conditions of this Agreement.

Warranty and Limitation of Liability

- a. **No Warranties:** The Software is provided "as is" and Christie makes no warranty of any kind with regard to the Software. Christie will not be liable for errors contained in the Software or in connection with the performance or use of the Software. Christie does not warrant that the Software is free from any defects or that it will operate uninterrupted. Christie warrants that the media on which the Software is distributed will be free from defects in materials and workmanship under normal use for a period of ninety (90) days from the date of delivery. Christie will replace any defective media returned to Christie within the ninety (90) day period. The foregoing is Licensee's sole and exclusive remedy for breach of the warranty given

pursuant to this Section. Christie does not make any other warranties, either express or implied, including, but not limited to, implied warranties of merchantability, fitness for a particular purpose, title and non-infringement with regard to the Software.

- b. **Limitations of Liability:** IN NO EVENT WILL CHRISTIE BE LIABLE TO ANY PARTY FOR DIRECT, INDIRECT, SPECIAL, INCIDENTAL, OR CONSEQUENTIAL DAMAGES, INCLUDING LOST PROFITS, LOST REVENUES AND LOST DATA ARISING OUT OF THE USE OF THIS SOFTWARE AND ITS DOCUMENTATION, EVEN IF CHRISTIE HAS BEEN ADVISED OF THE POSSIBILITY OF SUCH DAMAGE.

CHRISTIE SPECIFICALLY DISCLAIMS ANY WARRANTIES OR CONDITIONS, INCLUDING, BUT NOT LIMITED TO, THE IMPLIED WARRANTIES OR CONDITIONS OF MERCHANTABILITY AND FITNESS FOR A PARTICULAR PURPOSE. THE SOFTWARE AND ACCOMPANYING DOCUMENTATION, IF ANY, PROVIDED HEREUNDER IS PROVIDED "AS IS". CHRISTIE HAS NO OBLIGATION TO PROVIDE MAINTENANCE, SUPPORT, UPDATES, ENHANCEMENTS, OR MODIFICATIONS.

CHRISTIE FURTHER DISCLAIMS ANY AND ALL REPRESENTATIONS RELATING TO THIRD PARTY SOFTWARE WHICH IS EMBEDDED IN THE SOFTWARE. Some jurisdictions do not allow exclusions or limitations of certain conditions or warranties. Only those exclusions or limitations that are lawful in Licensee's jurisdiction will apply to Licensee and, in such instances, Christie's liability will be limited only to the maximum extent permitted by law.

Termination

- a. Christie may terminate this Agreement at any time and for any reason. Christie may also terminate this Agreement if the Licensee breaches or is in default of any obligation of Licensee under this Agreement. Upon termination of this Agreement, the Licensee will immediately (i) cease using the Software and (ii) uninstall the Software from any personal computers, servers or other devices (to the extent it is installed thereon). The Licensee's obligation under this provision will survive the termination of this Agreement.

General

- a. **Notices:** Unless otherwise set forth in this Agreement, all notices, or other communications hereunder will be deemed to have been duly given when made in writing and delivered in person, by courier or deposited in the mail, postage prepaid, and registered mail, return receipt requested, and addressed to Licensee at the billing address supplied to Christie by Licensee, and addressed to Christie at Christie Digital Systems USA, Inc., c/o Christie Digital Systems Canada, Inc. at 809 Wellington Street North, Kitchener, Ontario, Canada N2G 4Y7, with a copy (which will not constitute notice) to Christie's Legal Department at the same address.
- b. **Severability and Waiver:** Any provision of this Agreement which is held by any court to be unenforceable or invalid will be deemed severed from this Agreement, without affecting any other provision of this Agreement. No waiver by Christie of any particular default or omission committed by Licensee will affect or impair the right of Christie in respect of any subsequent default or omission of the same or a different kind. No delay or failure by Christie to exercise any rights in connection with any default or omission committed by Licensee will affect or impair Christie's rights in respect of that particular default or omission or any subsequent default or omission of the same or different kind. In any event, time will continue to be of the essence without the necessity of specific reinstatement.
- c. **Governing Law:** This Agreement is governed by the laws of the State of California, without regard to its conflict of law principles. Any suit or action arising out of or in connection with this Agreement will be brought in the federal or state courts located in Orange County, State of California. Each of Licensor and Licensee hereby irrevocably submit to the jurisdiction of such courts for the purpose of such suit or action and expressly and irrevocably waive, to the fullest extent permitted by law, any objection it may now or hereafter have to the venue of any such suit or action in any such court and any such claim that any suit or action has been brought in an inconvenient forum.

Notation

Learn the hazard and information symbols used in the product documentation.



Caution messages indicate a hazardous situation which, if not avoided, could result in permanent loss of data.



Notice messages indicate a hazardous situation which, if not avoided, could impact the application.



Information messages provide additional information, emphasize or provide a useful tip.

Content

- Getting started with Mystique. 10**
 - Mystique editions. 10
 - System recommendations. 12
 - Computer and software requirements. 12
 - Network requirements. 12
 - Camera recommendations. 13
 - Supported projectors. 15
 - Product documentation. 16
 - Related documentation. 16
 - Installing operating system patches. 16
 - Ensuring port 80 is not in use. 17
 - Installing Mystique. 17
 - Connecting the control computer to a projector and a camera. 18
 - Workflows. 19
 - Smooth screen configuration workflows for 2D layouts. 19
 - Playing surface configuration workflows. 19
 - Structured light calibration workflow for 3D layouts. 19
 - Automation controller calibration workflow for 3D layouts. 20
 - Manual calibration workflow for 3D layouts. 21
 - Color uniformity workflow for 2D layouts. 22
 - Color Matching workflow for 2D layouts using supported projectors and CIC 1DLP cameras. . . 22
 - Creating a Mystique configuration. 23
 - Opening an existing configuration. 23
 - Saving a configuration file. 23
 - Closing a configuration file. 23
 - Selecting the display theme. 24
 - Licensing Mystique. 24
 - Requesting an updated license. 24
 - Applying a new Mystique license. 24
 - Uninstalling Mystique. 25
 - Keyboard shortcuts. 25
 - Technical support. 27
- Managing projectors. 28**

Searching for a projector. 28

 Manually adding a projector to a configuration. 28

 Removing a projector from a configuration. 28

Identifying projectors in a configuration. 29

Reordering the projectors in a configuration. 29

Finding projector details. 29

Customizing default projector options. 29

Controlling a projector. 29

Connecting a Pandoras Box Manager as a projector. 30

Changing the order of channels in a configuration. 31

Renaming a channel. 31

Swapping channels. 31

Configuring cameras. 32

 Adding a camera to a configuration. 32

 Finding camera details. 32

 Adding a camera profile. 33

 Correcting lens distortion. 33

 Setting up the camera image. 33

 Adjusting camera exposure and binarization. 34

 Manually adjusting exposure and binarization. 35

 Calibrating cameras. 36

 Automatically calibrating the camera using an automatic controller. 36

 Performing an image-based calibration. 37

 Manually calibrating the camera. 38

 Adjusting the Camera View. 40

 Adjusting an image in Camera View. 40

 Saving an image from Camera View. 41

 Copying an image from Camera View. 41

 Removing a camera from a configuration. 41

Managing the image position and layout. 42

 Setting up screen definitions. 42

 Configuring a flat screen or a marked surface. 42

 Automatically setting up a cylindrical screen. 42

 Manually setting up a cylindrical screen. 42

 Setting up a spherical screen. 43

 Configuring a custom screen. 43

 Using a laser scan file to set up a screen. 43

Setting the units of measure.	44
Adjusting the System View.	44
Defining the layout.	45
Defining a simple layout.	45
Defining an advanced layout.	45
Defining the fields of view.	46
Defining the collimated fields of view.	47
Configuring the Projector Centric layout.	49
Performing a system calibration.	51
Confirming the configuration.	51
Gathering the configuration.	51
Running a full system calibration.	52
Running a partial system calibration.	52
Selecting calibration options.	53
Masking a projector to a screen.	54
Automatically adjusting projector focus.	55
Evaluating the content alignment.	56
Displaying a test pattern.	56
Applying warps and blends to a test pattern.	57
Adjusting a warp or blend.	57
Accessing a saved warp.	58
Accessing a saved blend.	58
Configuring the options for Twist.	58
Creating a 3D layout.	59
Hardware requirements for 3D configurations.	59
Workflows.	59
Structured light calibration workflow for 3D layouts.	60
Automation controller calibration workflow for 3D layouts.	61
Manual calibration workflow for 3D layouts.	61
Manually adjusting camera gain and exposure.	62
Specifying a model.	63
Manually calibrating cameras.	63
Configuring and gathering structured light.	64
Generating the point cloud.	65
Cropping points from the point cloud.	66
Locating the model.	66

Solving the layout.	67
Exporting a 3D layout.	67
Drawing a gather results test pattern.	67
Drawing a 3D test pattern.	68
Applying blends to a 3D layout.	68
Recalibrating a 3D layout.	68
Configuring black level blending.	70
Loading a previously saved black level blend.	70
Correcting black level tinting.	71
Estimating projector black levels.	71
Evaluating overall uniformity.	73
Adjusting the quality of a black level blend.	75
Saving a black level blend.	76
Maintaining the alignment of a projected image with Guardian.	77
Guardian requirements and limitations.	77
Configuring and starting a Guardian calibration.	79
Monitoring a Guardian calibration.	80
Mapping a playing surface.	81
Requirements for mapping a playing surface.	81
Adding devices to a configuration.	82
Searching for a projector.	82
Manually adding a projector to a configuration.	82
Connecting a Pandoras Box Manager as a projector.	82
Adding a camera to a playing surface configuration.	83
Defining the playing surface layout.	84
Defining a simple layout.	84
Defining an advanced layout.	84
Mapping the marker points on a playing surface.	85
Calibrating the camera.	86
Calibrating a playing surface configuration manually.	86
Performing an image-based calibration on a playing surface.	86
Using Christie Mystique Operate	89
About Christie Mystique Operate.	89
Supported browsers.	89
Adding scenes in Mystique Operate.	89

Navigating the Home page. 90

Controlling Guardian from Mystique Operate. 90

Configuring Mystique Operate to work with an external MPCDI media server. 91

 Configuring the media server PC. 91

 Configure Mystique PC. 91

Configuring Mystique Operate service to run on a different port. 92

Color/luminance uniformity. 93

 Requirements for making a uniform display. 93

 Performing a 2D projector alignment. 93

 Color uniformity workflow for 2D layouts. 93

 Adjusting Uniformity settings. 94

 Compensation type. 95

Camera assisted projector convergence. 96

 Automatically adjusting projector convergence 96

 Tuning electronic convergence: advanced convergence options. 96

Troubleshooting. 98

 Viewing and exporting diagnostics. 98

 Viewing diagnostic files. 98

 Exporting diagnostic files. 98

 I cannot load Mystique on my computer. 99

 Mystique cannot locate cameras or projectors. 99

 I cannot find or add a CIC 1DLP camera. 99

 I cannot connect to a Point Grey or FLIR camera. 100

 I cannot connect to a Teledyne Dalsa camera. 101

 Point Grey or FLIR camera performance is slow. 101

 Point Grey or FLIR camera stops working after networking change. 102

 Mystique cannot communicate with a connected device. 102

 An intermittent camera connection issue is occurring. 102

 Resolving an intermittent camera connection issue if network (GigE) cameras are installed. . 102

 Resolving an intermittent camera connection issue if USB cameras are installed. 104

 A camera has drifted out of position. 104

 The projector is unresponsive. 104

 The calibration file is invalid. 105

 High dx, dy values occur during camera calibration. 105

 The alignment results are poor. 105

 The camera performance is slow. 106

The camera and reference image do not align. 106

Mystique test patterns appear as expected but alignment is poor. 106

I am receiving an error message. 107

 Mystique failed to determine a channel ordering. 107

 The mapper generated no data. 107

 Warps have failed validation. 107

 A .Net framework initialization error occurred. 108

Projector undershooting is causing distorted blends. 108

Points in alignment patterns are missing. 108

An obstruction is appearing in the path of the projector image. 109

Technical support. 110

Getting started with Mystique

Mystique allows control, monitoring, and management of up to 256 projectors using a hosted web interface connected to the same network.

Read this guide to help understand the requirements and procedures for getting started.

Mystique editions

Learn the differentiating features of the five editions of Mystique. Each edition has a different license key requirement. For more information, contact your Christie sales representative.

Projector and camera support

Feature	Lite	Essentials	Pro Venue	Premium	Large Scale Experience
Channel	Up to 3 projectors wide, no stacking.	Up to 12 projectors (2x3 double stacked)	Unlimited All channels must be visible by a single camera	Unlimited	Unlimited
Camera	One	One	One	Unlimited	Unlimited

Screen support

Feature	Lite	Essentials	Pro Venue	Premium	Large Scale Experience
Flat	Supported	Supported	Supported	Supported	Supported
Cylindrical	Not supported	Not supported	Supported	Supported	Supported
Spherical	Not supported	Not supported	Not supported	Supported	Supported
Custom	Not supported	Not supported	Not supported	Supported	Supported
Dual screen	Not supported	Not supported	Not supported	Not supported	Supported

Layout support

Feature	Lite	Essentials	Pro Venue	Premium	Large Scale Experience
Wallpaper (Simple)	Supported	Supported	Supported	Supported	Supported
Wallpaper (Advanced)	Not supported	Not supported	Supported	Supported	Supported
Field of view (FOV)	Not supported	Not supported	Not supported	Supported	Supported
Projector centric	Not supported	Not supported	Not supported	Not supported	Supported
3D	Not supported	Not supported	Not supported	Not supported	Supported

Additional feature support

Feature	Lite	Essentials	Pro Venue	Premium	Large Scale Experience
Mystique Operate	Not supported	Supported	Supported	Supported	Supported
Generic camera and lens profiles	Supported for two webcams	Supported	Supported	Not supported	Not supported
Anamorphic and fish-eye projector lenses	Not supported	Supported	Supported	Supported	Supported
Black level blending	Not supported	Not supported	Contact your Christie sales representative	Contact your Christie sales representative	Contact your Christie sales representative
Automation controller devices	Not supported	Not supported	Not supported	Supported	Supported
Surface markers	Not supported	Not supported	Supported	Supported	Supported
Pandoras Box support	Supported	Supported	Supported	Supported	Supported
Guardian	Not supported	Available for purchase. Contact your Christie sales representative	Available for purchase. Contact your Christie sales representative	Not supported	Not supported
Color and background uniformity	Not supported	Supported	Supported	Not supported	Not supported
Luminance uniformity	Not supported	Supported	Supported	Not supported	Not supported

Related information

Requesting an updated license (on page 24)

System recommendations

Understand the hardware and software requirements for Mystique.

Computer and software requirements

Learn the hardware and software recommendations for running Mystique.

Computer requirements

Minimum	Recommended
Intel 2-core processor from 2018 or newer	Intel Core i7-4700 or higher
5 GB of free disk space	10 GB of free disk space
4 GB RAM	<ul style="list-style-type: none"> • 8 GB RAM (up to eight HD or four 4K projectors) • 16 GB RAM (up to 24 HD or 12 4K projectors) • 32 GB RAM (up to 48 HD or 24 4K projectors)
A true color (32 bit) display with a minimum resolution of 1024 x 768 and support for Open GL 3.3 or later	A true color (32 bit) display with a resolution of 1920 x 1080 and support for Open GL 3.3 or later
1 Gbps Ethernet port	1 Gbps Ethernet port
<ul style="list-style-type: none"> • Microsoft® Windows® 8 64-bit If using Microsoft Windows 8.1, install the update located here: https://support.microsoft.com/en-us/help/2919355. • Microsoft Windows 10 64-bit • Microsoft Windows 11 64-bit 	Microsoft® Windows® 10 64-bit

Supported software

- Adobe Reader 11 or later
- Twist 2.10.0 or later

Christie recommends using Twist Premium with the Essentials and Pro Venue editions of Mystique, and Twist Pro with the Premium and LSE editions of Mystique. For more information about the features of Twist, refer to *Christie Twist User Guide (P/N: 020-101380-XX)*.

Network requirements

Learn the network requirements for Mystique.

- Unmanaged Gigabit Ethernet switch (quantity 1)
Typically, managed switches are compatible with Mystique, however they may be challenging to configure when placed between the control computer and an Ethernet camera.
Christie provides support only for managed networking equipment supplied by Christie.
The switch must support jumbo packets, and jumbo packets must be enabled on the control computer.

- Ethernet cable for each network device, such as computers, projectors, and cameras (quantity 1)
- 1 Power over Ethernet (PoE) injector or a PoE switch (if using a PoE camera)

Ports

The following ports are used by Mystique:

Port number	Used by
80	Mystique Operate Service
1900	Bonjour
3004	Mystique Operate Service
3141	Mystique Windows Camera Hub
3142	Mystique Windows Camera Hub
3956	GigE Vision Control Protocol
5350	Bonjour
5351	Bonjour
5353	Bonjour, AirPlay, Home Sharing, Printer Discovery

Camera recommendations

Mystique must be used with at least one of the following calibrated cameras provided by Christie.

The Essentials and ProVenue editions of Mystique only support using a single camera per configuration.



When mapping a playing surface, for the widest field of view in the camera image Christie recommends placing the camera as high as possible, for example by the broadcast booth.

- CIC 1DLP (required for color matching on GS Series, 4K860-iS, DWU15-HS, DWU19-HS, and DWU23-HS projectors)
- 3.2 MP USB3 FLIR Flea 3 USB FL3-U3-32S2M-C
- 5.0 MP Color Teledyne Dalsa Genie Nano C2420 G3-GC11-C2420-IF (required for color and background uniformity)
- 5.0 MP Mono GigE PoE FLIR Blackfly BFLY-PGE-50H5M-C
To use the Power over Ethernet (PoE) functionality of this camera, a PoE injector or a PoE-enabled hub or router is required. If the camera cannot be located on the network, use a PoE injector to connect the camera to the control computer, or connect the camera to a PoE-enabled hub or router.
- 5.0 MP Mono GigE PoE FLIR Blackfly BFLY-PGE-50S5M-C (required for Guardian)
- 5.0 MP GigE FLIR Flea 3 FL3-GE-50S5M-C
- Kowa 5 mm lens, model LM5JC10M
- Kowa 8 mm lens, model LM8JC10M
- Kowa 12 mm lens, model LM12JC10M
- Kowa 16 mm lens, model LM16JC10M

CIC 1DLP

This camera (P/N: 156-155102-XX) works with Mystique (Mystique Lite and Mystique Essentials only) and the following projectors:

- GS Series projectors
- DWU15-HS, DWU19-HS, and DWU23-HS
- 4K860-IS

To use this camera, perform these steps:

1. Connect the camera to a supported projector in your configuration, using the supplied USB cable.
2. Launch Mystique and add your projector(s).
3. Add your camera.



- The projector with an attached camera must be added to your configuration and powered on before you can add the camera to Mystique.
- To use the Color Matching feature on supported projectors, each projector must be paired with its own camera. For example, a two projector blended array, would require two CIC 1DLP cameras, which would each be connected to the respective projectors. Three projectors would need three cameras, and so on. For more information, refer to *Color Matching workflow for 2D layouts using supported projectors and CIC 1DLP cameras* (on page 22).

Genie Nano cameras

Genie Nano cameras require a network connection path to the laptop/PC driving them with an internal built in 1 Gigabit NIC. Using an external USB NIC adapter/dongle causes the MAC address to be changed dynamically between reboots and leads to the cameras not being detectable by Christie Mystique.

Genie Nano cameras are designed to optimally transfer internal component heat to the outer metallic body.

- Achieve basic heat management by mounting the camera onto a metal structure using its mounting screw holes.
- Improve heat dissipation by using a thermal paste between the camera body (not the front plate) and the metal structure.



If the camera is free standing (such as, not mounted) it will be warm to the touch. Christie recommends using gloves if cameras must be handled after having been recently used.

Choosing a camera

If using the Essentials or Pro Venue edition of Mystique and the requirements for the projectors in a configuration are known, use the Mystique Camera Calculator tool to select the most appropriate camera for the configuration.

1. In a browser, navigate to <https://www.christiedigital.com/help-center/tools-and-calculators/mystique-install-camera-calculator/>.
2. Enter the projection specifications in to the calculator and select **Update**.
A list of recommended cameras for the configuration is displayed under the projection specifications.

Ethernet I/O automation controller

Learn the recommended Ethernet I/O automation controllers for Mystique.

- Christie ACT
- JNIOR Series 4, 412

Supported projectors

Use Mystique with at least one of the following supported projectors or with Pandoras Box.

Projector	Main software version	Guardian	Color/ background uniformity, black level blend	Luminance uniformity
Boxer	2K20	1.7 or later	Supported	Supported
	2K30	1.7 or later	Supported	Supported
	4K20	1.6 or later	Supported	Supported
	4K30	1.6 or later	Supported	Supported
	Mirage 304K	1.6 or later	Supported	Supported
Crimson Series	1.1 or later	Supported	Not supported	Supported
D4K40-RGB	1.2.0 or later	Supported	Supported	Supported
Mirage 4K40-RGB	1.2.0 or later	Supported	Supported	Supported
Mirage SST	1.0.1 or later	Supported	Supported	Supported
Griffyn Series	1.3.0 or later	Supported	Supported	Supported
Christie M RGB Series*	1.1.0 or later	Supported (60 Hz)	Supported	Supported
D16WU-HS, D16HD-HS, D20WU-HS, and D20HD-HS	1.6.0 or later	Not supported	Not supported	Supported
D13WU2-HS and D13HD2-HS	1.6.0 or later	Not supported	Not supported	Supported
4K7-HS and 4K10-HS	1.3.0 or later	Not supported	Not supported	Supported
DWU760-iS, DWU760A-iS, DWU860-iS, DWU960-iS, and DWU960ST-iS	1.0.0 or later	Not supported	Not supported	Supported
4K860-IS**	1.0.0 or later	Not supported	Not supported	Supported
DWU880-GS, DWU880A-GS, DWU1100-GS, DWU1400-GS, DWU1400A-GS**	1.2.0 or later	Not supported	Not supported	Supported
DWU15-HS, DWU19-HS, DWU23-HS**	1.1.0 or later	Not supported	Not supported	Supported

* Guardian is not supported with the Christie M RGB Series when in Shifted Superposition mode. Refer to the *TruLife+ User guide (P/N: 020-103315-XX)* to disable this setting to use with Guardian.

** GS Series, 4K860-iS, DWU15-HS, DWU19-HS, and DWU23-HS projectors have a built in Color Matching feature controlled from Mystique. For more information, see *Color Matching workflow for 2D layouts using supported projectors and CIC 1DLP cameras* (on page 22).

While the Essentials edition of Mystique supports a maximum of 2x3 stacked projectors, other editions of Mystique support an unlimited number of projectors.

Other supported hardware

- Pandoras Box 6.5 or later
When using Pandoras Box, blend quality is dependent upon projector support for gamma 2.2. Guardian, black level blending, color/luminance uniformity, auto focus, and electronic convergence are not supported on Pandoras Box.

Product documentation

For installation, setup, and user information, see the product documentation available on the Christie website. Read all instructions before using or servicing this product.

1. Access the documentation from the Christie website:
 - Go to this URL: <http://bit.ly/2INXz54> or <https://www.christiedigital.com/en-us/business/products/mystique>.
 - Scan the QR code using a QR code reader app on a smartphone or tablet.



2. On the product page, select the edition and switch to the **Downloads** tab.

Related documentation

Additional information on this product is available in the following documents.

- *Mystique Operate API Commands Guide* (P/N: 020-102628-XX)
- *Twist User Guide* (P/N: 020-101380-XX)

Installing operating system patches

The following patches must be installed on the operating system before installing Mystique

Windows 8 64-bit

- <https://support.microsoft.com/en-us/help/2919355>
- <https://www.microsoft.com/en-us/download/details.aspx?id=49082>

Windows 8.1 64-bit

- <https://support.microsoft.com/en-us/help/2919355/windows-rt-8.1,-windows-8.1,-and-windows-server-2012-r2-update-april-2014>
- <https://www.microsoft.com/en-us/download/details.aspx?id=49082>

Windows 10 64-bit

- No patches are recommended at this time.

Windows 11 64-bit

- No patches are recommended at this time.

Ensuring port 80 is not in use

Verify no other programs are using port 80 before installing Mystique.

There are two known services that might use port 80—the World Wide Web Publishing Service, and the Web Deployment Agent Service. If either service is running on your system, stop the service and change the startup type of the service to Manual before you install Mystique.

1. On your computer, select **Start > Control Panel > Administrative Tools > Services**.
2. Locate the **World Wide Web Publishing Service**.
3. Right-click the service and select **Properties**.
4. In the Startup type list, select **Manual**.
5. In the Service status area, select **Stop**.
6. Select **Apply**.
7. Repeat steps 2 to 6 for the **Web Deployment Agent Service**.

Related information

Configuring Mystique Operate service to run on a different port (on page 92)

Installing Mystique

To load Mystique, complete the following steps.

If a restart prompt appears before the installation is complete, select **No**.

1. Make sure all operating system patches are installed.
2. If an existing AutoCal or Mystique installation exists on the computer, Christie recommends uninstalling the application prior to loading the latest version of Mystique, unless the older installation is required for compatibility with older hardware.

If an existing AutoCal or Mystique installation is uninstalled after loading the latest version of Mystique, Mystique may need to be removed and re-installed to correctly restore all drivers and dependencies.
3. Insert the Christie installation media in to the USB drive on the computer.

If the installation does not start automatically, select **Start > Computer**. Browse to the Mystique installation media, and double-click the **MystiqueSetup.msi** file that corresponds to the installed version of Windows.

4. Select **Next**.
5. To proceed with the Mystique installation, select **Next**.
6. Select **I accept the terms in the License Agreement** and select **Next**.
7. Select **Install**.
8. Select **Finish**.
The Mystique installation is complete.
9. When the installation is complete, restart the computer.

Related information

Installing operating system patches (on page 16)

Ensuring port 80 is not in use (on page 17)

Connecting the control computer to a projector and a camera

A minimum of one camera and one Mystique-enabled projector must be connected to the control computer.

1. Connect a computer to a network switch with an Ethernet cable.
A wireless connection is not recommended with network (GigE) cameras.
2. Connect an Ethernet cable from each projector to the network switch.
Each projector requires a unique IP address and must be added to the same network subnet as the control computer. For more information, refer to the projector documentation.
3. Connect the camera to the control computer over Ethernet or with a USB connection.
 - **Ethernet**—Connect the camera and the control computer to an unmanaged switch.
If a camera is connected to the control computer with an Ethernet connection it must have a valid IP address and be accessible on the local network.
Do not connect network cameras to a managed switch. Camera drivers are loaded by the Mystique Setup Wizard.
 - **USB connection**—Use the cable supplied with the camera or a high quality equivalent.
Cameras connected with a USB connection are typically connected directly to the control computer, but a high quality USB hub or repeater can also be used. To determine what extenders or hubs are supported, see the camera supplier website.
Flea3 GigE cameras come with a power supply that must be connected, while other camera models receive power through a USB or a POE connection. If a Qalif camera is being used, verify it is operating in Remote mode.
Typically, cameras work correctly with Mystique without modifying their settings. If you need to modify camera settings, see the documentation provided by the camera manufacturer or visit their website. Software tools provided by the camera manufacturer are installed in **Start > Mystique**.

Camera drivers are loaded by the Mystique Setup Wizard.

Workflows

Understand the different ways of creating and calibrating a Mystique configuration.

2D configurations:

- **Smooth screen layout** (on page 19)—Displays content on a smooth screen or surface in 2D.

3D configurations:

- **Manual calibration** (on page 21)—Requires an operator to manually identify correspondences between model features in the CAD model and the same features as seen through each camera.
- **Automation controller calibration** (on page 20)—Performs a 3D calibration using an automation controller device.
- **Structured light calibration** (on page 19)—Requires minimal manipulation of known calibration data to align the model and camera.

Smooth screen configuration workflows for 2D layouts

When creating a configuration for a flat or cylindrical screen, perform these steps.

1. *Add the projectors throwing light onto the surface* (on page 28).
2. *Add the cameras that can view the projection surface* (on page 32).
3. *Define the screen space* (on page 42).
4. *Calibrate the cameras* (on page 36).
5. *Set the type of layout and the projector orientation* (on page 45).
6. *Run a full system calibration on the configuration* (on page 51).
7. *Create or adjust any blends or warps on the projected image* (on page 56).

Playing surface configuration workflows

When creating a configuration for a flat or cylindrical screen, perform these steps.

1. *Add the projectors throwing light onto the surface* (on page 28) or *connect a Pandoras Box Manager as a projector* (on page 30).
2. *Add the cameras that can view the projection surface* (on page 32).
3. *Define the screen space* (on page 42).
4. *Map the markers points on the playing surface* (on page 85).
5. *Calibrate the cameras* (on page 36).
6. *Run a full system calibration on the configuration* (on page 51).

Structured light calibration workflow for 3D layouts

Create a 3D layout by aligning the point cloud provided with the 3D model and the point cloud generated by Mystique.

1. *Add the projectors throwing light onto the surface* (on page 28).
2. Switch to the **Projector Control** tab.

3. To enhance the contrast on the projection surface, making the edges and features more visible to the cameras, select a projector and set it to use a combination of black and grey test patterns.
4. Switch to the **Install** tab.
5. *Add the cameras that can view the projection surface* (on page 32).
6. (Optional) *Manually set the exposure for the cameras* (on page 62).
7. *Select the 3D model* (on page 63).
8. Expand the Calibration pane, and select **Structured Light**.
By default, Mystique has the **Use single projector correspondences** option enabled while performing camera calibration. This allows Mystique to make a consistent camera network. If the generated point cloud is not consistent, try clearing the **Use single projector correspondences** checkbox.
9. *Configure the Structured Light settings* (on page 64).
10. *Gather the information about the scene through test patterns and projector associations* (on page 64).
11. Select **Baseline Camera Calibration**.
12. *Generate a point cloud of the scene from the projector and camera associations and the calibrations* (on page 65).
13. If the point cloud has data not relevant to the model, *remove all unnecessary points* (on page 66).
14. Align the point cloud with the model.
 - a) To change the angle of the viewport contents, right-click and adjust the orientation of the point cloud.
 - b) Select **Reorient Point Cloud**.
 - c) Select and drag three points of the camera point cloud onto the corresponding locations on the model.
15. *Align the generated point cloud with the model point cloud data.* (on page 66)
16. Evaluate how closely the scene point cloud matches the model point cloud.
The two point clouds must overlap exactly. If the matching does not appear to be exact, repeat steps 13 to 16.
17. *Determine the position of the projectors* (on page 67).
18. To verify the layout is correct, *draw a test pattern on the model* (on page 68).
If the layout must be corrected, repeat steps 13 to 18.
19. *Blend the content areas for all projectors in the configuration* (on page 68).
20. To transfer the projector and camera location information to the content system, export the calibration file.

Automation controller calibration workflow for 3D layouts

Perform a 3D calibration using an automation controller device.

1. *Add the projectors throwing light onto the surface* (on page 28).
2. Switch to the **Projector Control** tab.

3. To enhance the contrast on the projection surface, making the edges and features more visible to the cameras, set the projectors to use a combination of black and grey test patterns.
4. *Add the cameras that can view the projection surface* (on page 32).
5. (Optional) *Manually set the exposure for the cameras* (on page 62).
6. *Select the 3D model* (on page 63).
7. *Calibrate the cameras using an automation controller device* (on page 36).
8. *Gather the information about the scene through test patterns and projector associations* (on page 64).
9. *Create a point cloud of the scene from the projector and camera associations and the calibrations* (on page 65).
10. If the point cloud has data not relevant to the model, *remove all unnecessary points* (on page 66).
11. *Align the generated point cloud with the model point cloud data.* (on page 66)
12. Evaluate how closely the scene point cloud matches the model point cloud.
The two point clouds must overlap exactly. If the matching does not appear to be exact, repeat steps 11 to 13.
13. *Determine the position of the projectors* (on page 67).
14. To verify the layout is correct, *draw a test pattern on the model* (on page 68).
If the layout must be corrected, repeat steps 11 to 15.
15. *Blend the content areas for all projectors in the configuration* (on page 68).
16. To transfer the projector and camera location information to the content system, export the calibration file.

Related information

Automatically calibrating the camera using an automatic controller (on page 36)

Manual calibration workflow for 3D layouts

Manual Calibration relies on an operator finding correspondences between model features in the CAD model and the features seen through the cameras. For each correspondence, the feature must be visible by a minimum of two cameras. Six correspondences are required per camera.

Prior to each subsequent alignment, make sure the correspondences align with the marked features.

1. *Add the projectors throwing light onto the surface* (on page 28).
2. Switch to the **Projector Control** tab.
3. To enhance the contrast on the projection surface, making the edges and features more visible to the cameras, set the projectors to use a combination of black and grey test patterns.
4. *Add the cameras that can view the projection surface* (on page 32).
5. (Optional) *Manually set the exposure for the cameras* (on page 62).
6. *Select the 3D model* (on page 63).
7. *Manually calibrate the cameras* (on page 63).
8. *Gather the information about the scene through test patterns and projector associations* (on page 64).

9. *Create a point cloud of the scene from the projector and camera associations and the calibrations* (on page 65).
10. If the point cloud has data not relevant to the model, *remove all unnecessary points* (on page 66).
11. *Align the generated point cloud with the model point cloud data.* (on page 66)
12. Evaluate how closely the scene point cloud matches the model point cloud.
The two point clouds must overlap exactly. If the matching does not appear to be exact, repeat steps 11 to 13.
13. *Determine the position of the projectors* (on page 67).
14. To verify the layout is correct, *draw a test pattern on the model* (on page 68).
If the layout must be corrected, repeat steps 11 to 15.
15. *Blend the content areas for all projectors in the configuration* (on page 68).
16. To transfer the projector and camera location information to the content system, export the calibration file.

Color uniformity workflow for 2D layouts

To make projectors in a 2D configuration appear more uniform, perform these steps.

1. *Configure a 2D layout* (on page 19).
2. *Run a full system calibration on the configuration* (on page 52).
3. From the Color/Luminance uniformity tab, enable and configure your color calibration options.
4. To run a color calibration, make sure the **Enable Uniformity Correction** checkbox is selected and select **Run** in the ribbon.
5. Review the result on the screen to see if adjustments are needed.
Reduce compensation by using the slider on the Color/Luminance Uniformity tab.
6. If additional refinements are required, from the Color/Luminance Uniformity tab, select **Advanced** and make adjustments based on the histogram to ignore outlying areas of luminosity.
7. To apply the adjusted settings, from the Color tab, select **Send Adjustments to all Projectors**.

Color Matching workflow for 2D layouts using supported projectors and CIC 1DLP cameras

The following supported projectors have a built in Color Matching feature controlled from Mystique (Mystique Lite and Mystique Essentials only).

- GS Series
- DWU15-HS, DWU19-HS, and DWU23-HS
- 4K860-IS



The **Image Settings > Picture Settings** option must be set identical on each projector in the layout before running Color Matching.

To Color Match the projectors, perform these steps:

1. *Configure a 2D layout* (on page 22).
2. Connect a CIC 1DLP camera to each projector in the layout and make sure it is pointed at the screen.
3. Select **Home > Tools Ribbon > Color Match**.
4. Correct any reported errors and repeat step 3.
If successful, the results are automatically saved in the projector as the most recent color match.
5. To compare the most recent result with the previous result, select the down arrow next to **Color Match** and select **Restore Previous Color Match**.
6. To compare factory default settings, select the down arrow next to **Color Match** and select **Reset Color Match**.

Creating a Mystique configuration

After the installation is complete, open Mystique and create a configuration.

1. On your computer, select **Start > All Programs > Christie > Mystique 2.9**.
2. To create a new configuration, do one of the following.
 - If the environment uses a flat or cylindrical screen and has a basic layout, to complete a quick configuration setup, select **Smooth Screen Guided Setup**.
 - To display content on a smooth screen or surface in 2D, select **New Smooth Screen Layout**.
 - To projection map a multidimensional scene, select **New 3D Layout**.

Opening an existing configuration

To load a saved configuration file, complete the following steps.

1. In Mystique, select **Open**.
2. Browse to the location of the configuration file (*.cal).
3. Select the file and select **Open**.

Saving a configuration file

Learn how to save a file you create or edit in Mystique.

1. Switch to the **File** tab.
2. To save the file, select **Save** or **Save As**.
3. Navigate to the location where the configuration will be saved and select **Save**.

Closing a configuration file

Learn how to close a configuration file created or edited in Mystique.

1. Switch to the **File** tab.
2. Save the configuration file.
3. Select **Close Configuration**.

Selecting the display theme

You can select either a light or dark mode for the Mystique display theme.

1. Switch to the **Help** tab.
2. To switch between the light and dark themes, select **Dark Mode**.

Licensing Mystique

All editions of Mystique, except Mystique Lite, require a license dongle and valid license to identify the available features within the software. If the license dongle is lost or altered, Mystique does not function.

Requesting an updated license

To add features to the Mystique license or to change the product tier, a new license file must be requested.

1. Connect the Mystique license dongle to the computer where Mystique is installed.
2. Select **License Details**.
3. Select **Upgrade**.
4. Select **Request Upgrade**.
The .DAT file with the required information is copied to the license dongle.
Alternatively, to create a .DAT file, select **CTRL+SHIFT+Q**.
5. To close all License dialogs, select **Close**.
6. Navigate to the contents of the license dongle, and copy the .DAT file into an email.
7. In the email with the .DAT file, identify the license tier to upgrade to.
8. Send the license request to Christie Customer Service at orders@christiedigital.com.
After the license upgrade has been approved, a new license key is returned through email.
9. When the updated license is received, apply the new license to Mystique.

Related information

Applying a new Mystique license (on page 24)

Mystique editions (on page 10)

Technical support (on page 27)

Applying a new Mystique license

After receiving an updated license file, apply the license to Mystique.

1. When the email containing the updated license is received, copy the .KEY file from the email to the license dongle.
The .KEY file must be on the original Christie license dongle for the upgrade to complete successfully.
2. Connect the Mystique license dongle to the computer where Mystique is installed.
3. Right-click the Mystique shortcut and select **Run as Administrator**.

Mystique reads the files on the license dongle, and automatically detects an upgraded license file.

4. In the Upgrade License dialog, to apply the new license file, select **Continue Upgrade**.
5. After the upgraded license is applied to Mystique, in the confirmation dialog select **Close**.

Related information

Requesting an updated license (on page 24)

Uninstalling Mystique

Remove Mystique using the Windows Control Panel.

Bonjour, Microsoft® Visual C++ 2010, 2012, 2015, 2019 Redistributables, and Microsoft .NET Framework 4 may be in use by other programs and are not uninstalled by the wizard.

1. On a Windows® 8 computer, select **Start > Control Panel > Programs and Features**.
On a Windows® 10 computer, select **Settings > Apps & features**.
2. Right-click Christie Mystique and select **Uninstall**.
3. Select **Yes**.

Keyboard shortcuts

Learn keyboard shortcuts for Mystique.

General shortcuts

Action	Shortcut
Launch Guided Setup	CTRL+G
Create a new .cal file	CTRL+N
Open an existing .cal file	CTRL+O
Save changes to a .cal file	CTRL+S
Save a .cal file as	CTRL+SHIFT+S
Run a calibration	CTRL+R

System View and Screen Marker shortcuts

Action	Shortcut
View a single window	ALT+1
View two vertical windows	ALT+2
View two horizontal windows	ALT+3
View four windows	ALT+4

Action	Shortcut
Zoom in on the viewport	Scroll wheel on mouse
Zoom in on area around the mouse pointer in Camera or System view	CTRL
Add a marker on the model	ALT+Left click
Move a marker point on the model	ALT+Left click and drag
Increase or decrease a marker point size in System view	ALT + Scroll wheel on mouse
Move the viewport on the X or Z axes	Left click and drag
Rotate the viewport on the X or Z axes	Right click and drag
Move the viewport on the Y axis	Center mouse button

Side panel navigation shortcuts

Action	Shortcut
Open the Projector pane	ALT+P
Open the Camera pane	ALT+C
Open the Calibration pane	ALT+I
Open the Options pane	ALT+O

Smooth screen layout shortcuts

Action	Shortcut
Open the Screen pane	ALT+S
Open the Layout pane	ALT+L
Open the Black Level Blending pane	ALT+B
Open the Color/Luminance Uniformity pane	ALT+U

3D layout shortcuts

Action	Shortcut
Open the Model pane	ALT+M
Open the Projector Camera Associations pane	ALT+S
Move the measured point cloud on the X and Z axes	SHIFT + Left mouse button
Rotate the measured point cloud on the X and Z axes	SHIFT + Right mouse button
Move the measured point cloud on the Y axis	SHIFT + Center mouse button

Diagnostics

Action	Shortcut
Open a diagnostics folder for the current session	CTRL+SHIFT+D
Open a diagnostics folder for the current session in the images directory	CTRL+SHIFT+I
Open a diagnostics folder for the current session in the log directory	CTRL+SHIFT+L

Technical support

Technical support for Christie Cinema products is available at:

- *Support.cinema@christiedigital.com*
- +1-877-334-4267
- Christie Professional Services: +1-800-550-3061 or *NOC@christiedigital.com*

Technical support for Christie Enterprise products is available at:

- North and South America: +1-800-221-8025 or *Support.Americas@christiedigital.com*
- Europe, Middle East, and Africa: +44 (0) 1189 778111 or *Support.EMEA@christiedigital.com*
- Asia Pacific (*support.apac@christiedigital.com*)
 - Australia: +61 (0)7 3624 4888 or *tech-Australia@christiedigital.com*
 - China: +86 10 6561 0240 or *tech-supportChina@christiedigital.com*
 - India: +91 (80) 6708 9999 or *tech-India@christiedigital.com*
 - Japan: 81-3-3599-7481
 - Singapore: +65 6877-8737 or *tech-Singapore@christiedigital.com*
 - South Korea: +82 2 702 1601 or *tech-Korea@christiedigital.com*
- Christie Professional Services: +1-800-550-3061 or *NOC@christiedigital.com*

Managing projectors

To manage all of the connected projectors, use the Projector Control tab.

Searching for a projector

Search by port number when adding a projector to the configuration.



The projector must be on the same subnet as the computer when searching by port number.

1. In the left pane, select **Projector**.
2. Select **Add**.
3. Select **Search**.
4. Select a projector.
5. Select **OK**.

Manually adding a projector to a configuration

If a projector is not automatically detected, or if it is not on the same subnet as other projectors in a configuration, you can manually add the projector to the configuration by entering the projector IP address and port number.

To manually add a projector to a configuration, you must know the IP address and port number of the projector. To find the IP address of a projector, refer to the projector documentation.

1. In the left pane, select **Projector**.
2. Select **Add**.
3. On the Manual tab, enter the **IP Address** and **Port** number of a projector.
4. Select **Search**.
5. Select the projector.
6. Select **OK**.

Removing a projector from a configuration

To remove a projector no longer used in a configuration, complete the following steps.

1. Open a configuration file.
2. In the left pane, select **Projector**.
3. Select a projector and select **Remove**.

Identifying projectors in a configuration

Use the identify feature to display the Channel ID of each projector on the projection surface.

1. Switch to the **Projector Control** tab.
2. Select **Identify Projectors**.

The Channel ID of each projector in the configuration is displayed on the projection surface.

Reordering the projectors in a configuration

To organize the projectors in a way logical for the scene, change the order of the projectors in a configuration.

1. Open a configuration file.
2. In the left pane, select **Projector**.
3. Select a projector and select **Move Up** or **Move Down**.

Finding projector details

Follow these steps to find the address, software version, and model of a projector.

1. Open a configuration file.
2. In the left pane, select **Projector**.
3. Select a projector.
4. Expand the **Details** area.

Customizing default projector options

Customize the default options for projectors added to the configuration.

1. In the left pane, select **Options**.
2. At the bottom of the pane, expand the **Projector** area.
3. To manually adjust the settings, clear the **Automatic** checkbox.
4. To set the size (in pixels) of the grid points that Mystique draws during calibration, in the **Grid Box Size** field, select a size.
5. To set the spacing of the grid points that Mystique uses during calibration, in the **Spacing** field, make a selection.

This value is a multiplier of the grid box size.

Controlling a projector

With Mystique, commands can be sent directly to a projector from the computer.

If there are multiple projectors in the configuration, some projector controls such as power, test patterns, and opening or closing the shutter, can be performed on multiple projectors at once.

1. Switch to the **Projector Control** tab.
2. In the left pane, select **Projector**.
3. Select a projector, and do any of the following:
 - To turn on or off the projector, in the Power view, select **On** or **Off**.
 - To open or close the shutter on the projector, in the Shutter view, select **Open** or **Close**.
 - To change the input source, the test pattern, the warp or the blend, in the Projector view, select **Input**, **Test Pattern**, **Warp**, or **Blend**. In the list, make your modification.
 - To display markers on the screen, in the Draw view, select **Markers**.
 - To display a specific color on the screen, in the Draw view, select **Color**.
 - To display an image on the screen, in the Draw view, select **Image**.
 - To clear markers on the screen and keep a black background, in the Draw view, select **Black Fill**.
 - To display the results of marker collection, in the Draw view, select **Gather Test Pattern**.
 - To clear markers and any other drawn test pattern on the screen, in the Clear view, select **All**.

Connecting a Pandoras Box Manager as a projector

Learn how to add a Pandoras Box Manager as a projector in Mystique.

When connecting to a Pandoras Box Manager, each output in a Pandoras Box project appears as a projector in Mystique. While Mystique can connect to one Pandoras Box Manager at a time, multiple Pandoras Box clients can be connected to a single Manager.

Mystique, the Pandoras Box Manager, and all Pandoras Box Clients must be configured for, and run on, the same network.

For a blend for Pandoras Box to appear as expected, Christie recommends using projectors that can support a gamma curve of 2.2, such as Christie 3-chip DLP projectors. Otherwise, blend quality can vary.

1. In Pandoras Box Manager, verify the project file containing the content is open.
2. In Mystique, in the left pane, select **Projector**.
3. Select **Add**.
4. Do one of the following.
 - If the Pandoras Box Manager is installed on the computer used to run Mystique, from the Search Results list, select **PB Devices**.
 - If the Pandoras Box Manager is installed on another computer, or PB Devices does not appear in the Projector Search Results list, switch to the **Manual** tab. Enter the IP address of the Pandoras Box Manager, and select **Search** or **Clear & Search**. Your Pandoras Box devices should now show in the Projector Search Results list.
5. Select **OK**.

Once you connect to a Pandoras Box Manager, canvases for warping, blending, and test patterns are created in the Pandoras Box project. Establishing a consistent communication stream might take longer than expected.

When Mystique is run, warps and blends are added to the output and activated in Pandoras Box Manager.

Some projector controls, such as power and shutter controls, are unavailable when connected to a Pandoras Box Manager.

Changing the order of channels in a configuration

Each projector in a configuration is assigned to a channel. The order of the channels is the order in which Mystique processes events impacting projectors in a configuration.

1. In the left pane, select **Projector**.
2. Select a channel.
The Channel ID for the projector appears in the far left column of the Projector tab.
3. Select **Move Up** or **Move Down**.

Renaming a channel

Change the name of a channel used in a configuration.

1. Open a configuration file.
2. In the Projector pane, double-click a projector name.
3. Enter a new name.

Swapping channels

Depending on the defined layout, swap data between projectors in a configuration.

1. In the left pane, select **Layout**.
2. In the Type list, select an option.
Data between projectors can be swapped in any of the following layouts:
 - Wallpaper (Advanced)
 - Fields of View
 - Fields of View (Collimated)
 - Projector Centric
3. In the Channel Extents table, select two full rows.
4. To swap data between the two projectors, select **Swap**. 

Configuring cameras

Learn how to locate cameras, add them to the configuration, and change camera settings such as exposure and binarization.

Adding a camera to a configuration

To add a camera to a configuration, complete the following steps.

The Essentials and Pro Venue editions of Mystique only support using a single camera per configuration.

1. Open or create a configuration file.
2. In the left pane, select **Camera**.
3. Select **Add**.
4. Select the camera(s).
 - To select one camera, select a camera.
 - To select more than one camera, select and hold **CTRL** and select the cameras.
 - To select all of the cameras, select **Select All**.
 - To clear your selection, select **Select None**.
5. To see a recently connected camera, select **Refresh**.
6. Select **OK**.

When a camera is added, a preview of the camera image appears in the Camera View.

Related information

Creating a Mystique configuration (on page 23)

Opening an existing configuration (on page 23)

I cannot connect to a Teledyne Dalsa camera (on page 101)

Finding camera details

To find details about the camera and network information, complete the following steps.

1. Open a configuration file.
2. In the left pane, select **Camera**.
3. Select a camera.
4. Expand the **Details** area.

Adding a camera profile

Camera profiles are stored on a camera and they define the technical characteristics of a camera and its lens.

If a separate camera profile is provided by Christie, complete the following steps to add the profile to Mystique.

1. Switch to the **Help** tab.
2. In the Camera Profiles area, select **Add**.
3. In the Open File dialog, browse to the .xml file that contains the camera profile.
4. Select the .xml file and select **Open**.
5. Select **OK**.

Correcting lens distortion

Learn how to correct pincushion or barrel distortions in configurations that use cameras or camera lens pairs that are not on the list of recommended cameras.

1. In the left pane, select **Camera**.
2. Select a camera.
3. Expand the **Details** area.
4. Double-click the Profile and select **Generic Intrinsic**s.
5. In the Lens field, select the focal length of lens on the camera.

Christie has identified a set of generic characteristics of the lens focal lengths listed, and uses generic values to correct for most lens distortion in those focal lengths. If the selected focal length does not correct the lens distortion being displayed, contact Christie Technical Support.

When using the Flir Blackfly GigE camera (BFLY-PGE-50S5M-C: 5.0 MP, SONY IMX264, MONO) or 5.0 MP Color Teledyne Dalsa Genie Nano camera (C2420 G3-GC11-C2420-IF) with any of the following lenses, the generic camera and intrinsic profiles in Mystique can be used.

- Kowa 5 mm lens, model LM5JC10M
- Kowa 8 mm lens, model LM8JC10M
- Kowa 12 mm lens, model LM12JC10M
- Kowa 16 mm lens, model LM16JC10M

FLIR cameras were previously known as Point Grey cameras.

Setting up the camera image

Before adjusting the digital settings for a camera, make sure the camera is in focus and the lens aperture is appropriately set.

Binarization defines the threshold of the black (dark) and white (bright) pixels of a captured image. By default, Mystique automatically determines the binarization threshold values. An ideal binarization occurs when the background noise of an image is minimized and all grid points are fully captured. If required, to manually change camera settings, such as exposure and binarization, use the Camera menu in the left pane.

Original binarization

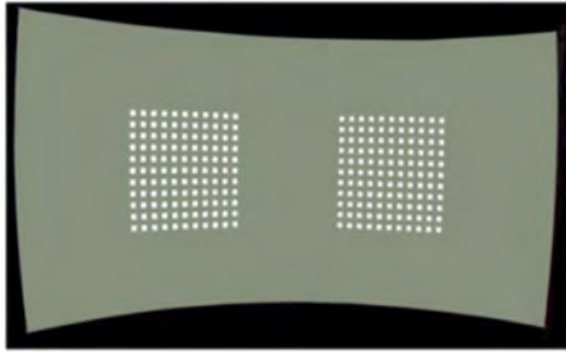

Correct binarization

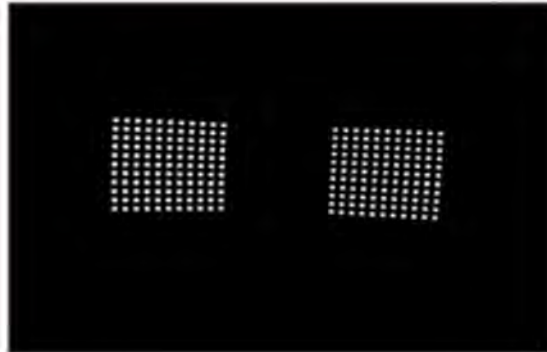

Binarization threshold too low



Binarization threshold too high

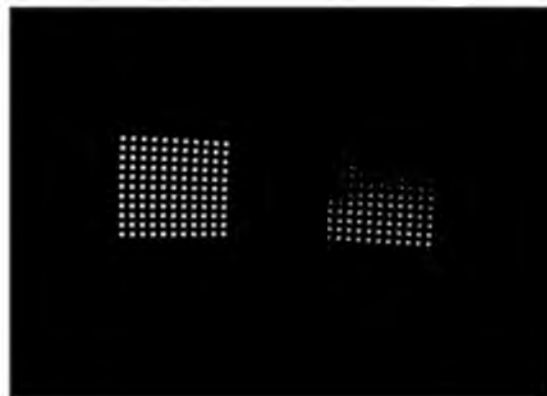

When a binarized image is taken, projectors in the system display a black background with a white grid. If Camera Markers is selected, the on-screen markers used for camera calibration are turned on. The correct binarization and exposure values are assigned by detecting these markers.

If a single camera and projector are activated, you can adjust the binarization threshold and camera exposure of the camera.

Adjusting camera exposure and binarization

Select how to adjust the camera exposure and binarization.

By default, Mystique automatically determines exposure and binarization settings. Before making changes to these settings, verify the following:

- The screen is defined.
- The required cameras are imported and activated.
- The required channels are imported and activated.
- The channel extents are defined.
- All points are mapped.

If using multiple cameras in a configuration, the binarization and exposure settings for each camera must be adjusted individually.

1. Connect at least one camera and select at least one channel.

2. In the left pane, select **Camera**.
3. Expand the **Exposure & Binarization** area.
4. In the list, select one of the following options:
 - **Automatic**—Automatically adjust exposure and binarization based on the lighting conditions of the scene. Christie recommends this setting for use if lighting conditions cannot be controlled, for example, an outdoor space.
 - **High Contrast**—Automatically adjust exposure and binarization using additional inverse test patterns recorded by the system. This setting can improve image processing and contrast and is recommended for use if ambient light levels are low, or lighting conditions are not manually controlled.
 - **Manual**—Manually configure unique exposure and binarization settings. Christie recommends this setting for use if lighting conditions remain consistent between calibration runs.

Manually adjusting exposure and binarization

If necessary, manually adjust the exposure and binarization settings.

Binarization evaluates the image projected on the screen and converts the image to black and white, without any grey. This conversion occurs when all ambient light is filtered out and the image displays only the grid points in their sharpest context.

When making an adjustment, find a balance between the correct exposure and binarization threshold. If there are multiple cameras in a configuration, the binarization and exposure settings must be adjusted for each individual camera.

1. Connect at least one camera and select at least one channel.
2. In the left pane, select **Camera**.
3. Expand the **Exposure & Binarization** area.
4. In the list, select **Manual**.
5. To change the projector grid settings, or to change the camera calibration marker settings, in the Marker Type list, select **Projector Dots** or **Screen Markers**.
6. To adjust the brightness of the camera image, drag the **Gain** slider back and forth or select the **-** and **+** buttons.
7. To adjust how long the camera shutter stays up when capturing images, drag the **Exposure** slider back and forth or select the **-** and **+** buttons.

Christie recommends adjusting the exposure until the brightest projected square is almost pure white.
8. Select a binarization threshold that makes the projected pattern as clear as possible.
 - a) Select **Thresholding On**.
 - b) Drag the **Threshold** slider back and forth or select the **-** and **+** buttons until the image reaches an optimal threshold.

Adjusting the threshold changes the image so anything above the threshold is white, and anything below the threshold is black. Try to avoid losing points when adjusting the binarization. To turn off binarization threshold, select **Thresholding Off**.

Calibrating cameras

To map content correctly, Mystique must know where the screen, playing surface, or object is located in the camera image.

When the Calibration menu is opened in the left pane, two display windows appear. On the left, the Camera View displays a real-time picture. On the right, the System View displays a representation of the configuration. To display, hide, or reorder windows, you can select one of the options in the upper-right hand corner of the screen.

Depending on the complexity of the configuration, choose from one of the following methods for camera calibration.

- **Automation controller calibration**—If the configuration is complex, or if using a multiple camera system, Christie recommends using an automation controller device to perform an automatic camera calibration using known features of a surface or LED markers at known 3D points. This method allows cameras to be automatically calibrated by toggling the LED markers on and off in a pattern.
- **Image-Based**—When mapping an arena surface that has painted markers on it, or if the screen is flat, Christie recommends performing an automatic camera calibration using features that appear on the surface itself. After performing an initial calibration, this mode can automatically recalibrate the camera if it is bumped or moved slightly. This method is intended for use with a single camera.
- **Manual**—If the screen is flat or cylindrical, and the configuration uses a single camera, Christie recommends performing a manual calibration using the corners and edges of a screen.

Related information

Automatically calibrating the camera using an automatic controller (on page 36)

Performing an image-based calibration (on page 37)

Manually calibrating the camera (on page 38)

Automatically calibrating the camera using an automatic controller

Use an Ethernet I/O automation controller, such as Christie ACT and JNIOR Series 4, 412 devices, to control the visible markers of a connected camera. This feature is not supported by the Essentials and Pro Venue editions of Mystique.

A camera can only be calibrated using an automation controller if the size of the screen is determined manually.

For information on using an automatic controller, refer to the documentation provided with the device.

1. Open or create a configuration file.
2. In the left pane, select **Calibration**.
3. Select a camera.
4. Select automation controller from the list.
5. To add an automation controller to a configuration manually, select **Add** then enter the IP address of the device.
6. Do any of the following:
 - To receive a prompt before running the automatic camera calibration, select **Prompt for Calibration**.

- If a threshold value that works for all automation controller points cannot be obtained, to split a camera image in to zones and automatically threshold each zone individually, select **Threshold by Zone**.
 - To verify markers have been configured correctly and are visible in the camera view, select **All On** and **All Off**.
7. To run an automatic camera calibration, select **Calibrate Cameras**.
 8. To remove an automation controller from a configuration, select the device and select **Remove**.

Performing an image-based calibration

An image-based calibration may be performed if the screen size is determined using an image.

Christie recommends only performing image-based calibrations in settings where lighting conditions are consistent. If lighting conditions change between calibrations, manual camera calibration might be required.

After calibrating the camera, take a new reference image so if the camera is unintentionally moved out of position, it can automatically be recalibrated to align with the new reference image.

1. Open or create a configuration file.
2. In the left pane, select **Calibration**.
3. Select a camera.
4. Select **Image-Based** from the list.
5. If required, do any of the following.
 - To set the camera exposure manually, clear the **Enable Auto Exposure** checkbox, and move the slider.
 - When mapping a playing surface, to mask moveable features visible to the camera that are outside of the screen and not covered by the marked surface overlay, such as non-fixed seating or advertising, select **Use Screen as Mask**. This option is available only with the Pro Venue edition of Mystique.
6. Select **Calibrate Cameras**.
7. To take a new reference image, select **Take Reference Image**.

Recalibrating the camera to a reference image

When a camera is accidentally moved out of place, use a reference image to recalibrate the camera.

To recalibrate a camera using this method, a reference image of the configuration must have been previously taken using Mystique.

Christie recommends this method of recalibration when correcting for small motions of a fixed camera, such as a building vibration. If the camera is moved to a new location or its view is significantly altered, manually realign the camera for the new configuration and take a new reference image.

1. Open a configuration file.
2. In the left pane, select **Calibration**.
3. Select a camera.
4. Select **Image-Based** from the list.
5. To recalibrate the camera, select **Calibrate Cameras**.

Manually calibrating the camera

Map the 3D and 2D points for each camera in a configuration.

1. Switch to the **View** tab.
2. In the System View area, select **Points**.
3. Select a 3D point.
The point turns yellow.
4. To move a 3D point, change the values in the coordinate fields.
5. Select one of the following coordinate systems  ▼:
 - **Cartesian**—Base the position of the screen markers by X, Y, and Z coordinates. This is the default coordinate system.
 - **Cylindrical**—Base the position of the screen markers upon the Radius (the distance between the screen marker and the Z-axis), the Yaw (the angle of the screen marker about the Z-axis, and the Z (the height of the screen marker above the XY plane).
 - **Spherical**—Base the position of the screen markers upon the Radius (the distance between the screen marker and the origin), the Yaw (the angle of the screen marker about the Z-axis), and the Pitch (the angle of the screen marker from the horizontal plane).
6. To move the corresponding 2D point in the Camera View, in the Camera View list, select a camera.
7. Select and drag the 2D point or change its values in the marker table.
8. Repeat steps 6 and 7 for each 2D point that requires mapping.
9. Select **Save**.



Adding 3D points to the System View

If the screen size must be determined manually, add 3D points to the System View. If the screen size is determined automatically or by importing an image file, the points are added automatically.

To calibrate the camera, there must be a minimum of six points or, if they are coplanar, four points.

If working with a multiple camera installation, Christie recommends each pair of overlapping cameras share four points. The points should be distributed outward to the corners of the overlap area. If you follow this recommendation, the number of points required for a two camera installation is eight and six are seen by each camera.

When adding points automatically, Mystique removes any existing points and adds a new grid of points.

1. Switch to the **View** tab.
2. In the System View area, select **Points**.
3. In the Screen Markers window, select **3D Points** .
4. Select the number of horizontal and vertical points.
5. Select **OK**.
6. To adjust the position of a point, in the Screen Markers window, select the point and adjust the X, Y, and Z values.
7. To manually add a point, in the Screen Markers window, select **Add** .

8. To delete a point, in the System View window, select a point and in the Screen Markers area, select **Delete**.

Locating the corners of a screen

When using a single camera system and the Wallpaper (Simple) layout, Mystique can automatically locate the corners of a screen that correspond to the corners that are defined in the System View.

Before locating the corners of a screen, Christie recommends verifying the following:

- The screen has a well-defined border with a high degree of contrast between the screen area and the border.
- There are no objects between the camera and the screen that could obscure the view of the camera.
- The camera aperture is set so the image is visible but not over exposed.
- The camera focus is adjusted to provide a clear, sharp image.
- The center of the Camera View is in the center of the screen.
- The entire screen is visible to the camera.

This feature is best suited for use with planar rectangular screens.

1. Switch to the **Home** tab.
2. In the Tools area, select **Find Corners**.
In the Camera View window, after Mystique searches for corners, blue dots appear in the corners of the screen and blue lines appear along the edge of the screen.
If a Cylindrical option is selected, to represent the curved edges of the screen, the blue circles appear on the top and bottom of the screen area.
3. If necessary, adjust the corner points to match the corner of the screen.
4. To add 2D calibration points, select the points with the mouse and then drag them from the System View to the Camera View.
5. If necessary, manually adjust the corner points.
 - a) Select and drag the blue circle.
When you select or drag a circle, the circle becomes yellow and hollow.
 - b) Drag all four circles to their required locations.
 - c) For fine adjustments to corner locations, select and hold the **CTRL** key.
A zoom window appears.

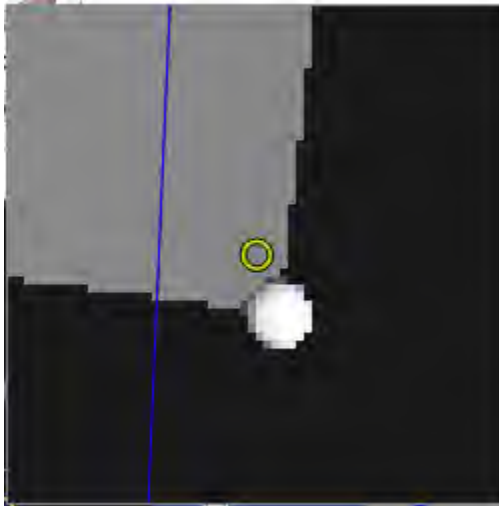

- d) Move the circles as required.
To move a selected circle by 10 pixels, select **CTRL** + the arrow keys.
To move a circle by one pixel, select **CTRL + SHIFT** + the arrow keys.
- e) To close the zoom window, release the **CTRL** key.

Adjusting the Camera View

To see what is currently visible to the cameras in a configuration, use Camera View.

1. Switch to the **View** tab.
2. In the Camera Views pane, select any of the following options:
 - **Calibration Points**—Shows the calibration points around the edges of the screen.
 - **Channels**—Shows the projector display area on the screen for the current configuration.
 - **Screen**—Shows the screen outline.
 - **Screen Grid**—Displays a grid on the screen showing the interior shape of the screen (as a blue grid).
 - **Projectors**—Shows the area that a projector can cover.
To confirm that overlays are present outside of the screen boundary, Christie recommends using the RANSAC fit solver when selecting projectors.
 - **Mappers**—Shows where projector mappers are detected and the margin of error detected between cameras.
 - **Features**—Shows matched features on the projection surface after taking a reference image.

Adjusting an image in Camera View

Make adjustments to images in Camera View using the mouse or the icons that appear at the top of the window.

1. Switch to the **Camera View**.
2. To make adjustments to an image, do any of the following:

- To change the position of an image, select the left mouse button and drag an image.
- To zoom in or out on an image, use the wheel button on the mouse or, at the top-left of the window select **Zoom In** or **Zoom Out**.
- To fit the current image to the Camera View window, at the top-left of the window, select **Fit**.
- To pause the real-time view from the camera, in the top-left of the window, select **Pause**.
- To change the opacity of an image appearing over the camera view, in the top-left of the window, move the **Opacity** slider left or right.
- To add a high-pass filter to the screen or object to view its edges, in the top-right of the window, move the **Sharpness** slider left or right.
- To capture a camera reference image and carry forward any marker points specified, in the left pane, select **Calibration**. Select **Image-Based** and select **Take Reference Image**.

Saving an image from Camera View

Learn how to save an image from Camera View.

1. Switch to the **Camera View**.
2. In the Camera Views pane, select **Save Camera View**.
3. In the Save As dialog, navigate to a location on your hard drive where you want to save the view and select the type of image you want to save.
4. Select **Save**.

The name of the file defaults to the camera name, for example Camera_01.png.

Copying an image from Camera View

Learn how to copy an image from Camera View if you do not want to save the image to the hard drive. You can then copy and paste it into, for example, an email or an editing application.

1. Switch to the **Camera View**.
2. To take a picture of an image and copy it to the clipboard, select **Copy**.
3. Paste the image in the application where you want to use it.

Removing a camera from a configuration

To remove a camera from a configuration, complete the following steps.

1. Open or create a configuration file.
2. In the left pane, select **Camera**.
3. Select a camera and then select **Remove**.

Managing the image position and layout

To manipulate a display image, set up screen definitions and define the layout of the screen.

Setting up screen definitions

Learn how to set up the geometry definitions that define the characteristics of the physical projection surface.

Configuring a flat screen or a marked surface

To configure a flat screen, or to map a playing surface, complete the following steps.

1. In the left pane, select **Screen**.
2. In the Shape list, select **Flat**.
3. In the **Determine Size** list, select one of the following screen parameters:
 - **Automatically**—Determine the screen or marked surface width and height using the camera calibration markers.
 - **Manually**—When installing more than one camera, or manually specifying the width and height, use this option and in the **Scene Units** list, select a unit of measurement.
 - **From Image**—If mapping a playing surface, import a .png file of a marked surface. This option is only available with the Pro Venue edition of Mystique or higher.

Automatically setting up a cylindrical screen

With Mystique, the dimensions of a cylindrical screen can automatically be defined.

1. In the left pane, select **Screen**.
2. In the Shape list, select **Cylinder**.
3. In the Determine Size list, select **Automatically**.
4. To adjust the top and bottom radii independently, clear the **Lock Radius** checkbox.

Manually setting up a cylindrical screen

If more than one camera is installed in a configuration, the dimensions of the screen must be manually defined.

1. In the left pane, select **Screen**.
2. In the Shape list, select **Cylinder**.
3. In the Determine Size list, select **Manually**.

4. In the Scene Units list, select a unit of measurement.
5. Specify the screen **Radius**.
6. Specify the **Height** of the screen.
7. To define the minimum horizontal angle measured from the center of the screen to the left side, enter a **Min. Angle** value.
8. To define the maximum horizontal angle measured from the center of the screen to the right side, enter a **Max. Angle** value.

Setting up a spherical screen

When setting up a spherical screen, the radius, vertical angles, and horizontal angles of the screen must be defined.

1. In the left pane, select **Screen**.
2. In the Shape list, select **Sphere**.
3. In the Scene Units list, select a unit of measurement.
4. Specify the screen **Radius**.
5. To define the minimum horizontal angle measured from the center of the screen to the left side, enter a **Min. H. Angle** value.
6. To define the maximum horizontal angle measured from the center of the screen to the right side, enter a **Max. H. Angle** value.
7. To define the minimum vertical angle measured from the center of the screen to the bottom, enter a **Min. V. Angle** value.
8. To define the maximum vertical angle measured from the center of the screen to the top, enter a **Max. V. Angle** value.

Configuring a custom screen

Define custom screen shapes with Mystique.

When using this option with a wallpaper or projector centric layout, make sure the screen is parameterized with UV texture mapping coordinates.

1. In the left pane, select **Screen**.
2. In the Shape list, select **Custom**.
3. In the Screen File Units list, select a unit of measurement.
4. In the Content Screen field, navigate to an .obj file.
5. Select a file and select **Open**.

Using a laser scan file to set up a screen

If the content screen designed using Mystique does not align with the projection surface in the real world, scan or map the projection surface and import the file into Mystique as an .obj file.

Before importing a laser scan file into Mystique, the following tasks must be complete.

- A content screen (.cal) file must be saved to the computer.
- The content screen file must be correctly parametrized.

- A laser scan file must be saved to the computer.
- The selected layout in Mystique must be Projector Centric.



When the Projector Centric layout is selected, channel extent previews use approximate values.

1. In the left pane, select **Screen**.
2. In the Shape list, select **Custom**.
3. In the Content Screen field, browse to and import a content screen file.
4. In the Measured Screen field, browse to and import a laser scan file.

After importing a laser scan file, when performing a system calibration, Mystique calibrates to the laser scan file measurements.

Setting the units of measure

Change the units used for all measurements.

1. In the left pane, select **Options**.
2. In the System Units list, select the units for all measurements.

Adjusting the System View

The System View is a representation of your configuration that includes the shape of your screen and the 3D axes of the eye point.

1. Switch to the **View** tab.
2. In one of the center areas, select **System View**.
3. Select the options to include in the System View.
 - **Surface**—Show the screen surface.
 - **Wireframe**—Show a wireframe of the screen surface.
 - **Points**—Show the screen surface vertices.
 - **Origin**—Show the X, Y, and Z axes at the location of the origin.
 - **Eye point**—Show the eye point location for the configuration.
 - **Channels**—Show the areas that each projector can reach on the screen with the configuration.
 - **Reprojection**—Show a heatmap that highlights areas on the projection surface where the calibration of the configuration can be improved.
 - **PCD**—Show the PCD reference points.
 - **Cloud**—Show the measured point cloud.
4. To rotate the image, click the left mouse button and drag.
5. To change the position of the image, click the right mouse button and drag.
6. To zoom in or out, use the wheel button on your mouse.
7. To return to the default axis positions, beside the View list select **Reset**.

Defining the layout

A channel is a slice of content sent to a projector. When defining the layout, the location of each channel, and where the pixels land within each channel in a configuration are defined.

Values that are entered must match the parameters of the content or image generator. If a configuration includes projectors that are stacked, channel extent values must be identical for each projector in the stack.

Define the channel extents for a configuration using one of the following methods:

- Wallpaper (Simple)
- Wallpaper (Advanced)
- Fields of View
- Fields of View (Collimated)
- Projector Centric

Warps are automatically generated so the projected image matches the layout specified in Mystique.

Defining a simple layout

If using a standard projector layout, such as a 2x2 or 2x3 stacked or a simple blended layout, select Wallpaper (Simple).

Channel layouts are defined by the overlaps between adjacent channels. Once defined, the projected area of all channels fills the entire screen or playing surface.

For a multi-camera installation, use the Wallpaper (Advanced) layout.

1. In the left pane, select **Layout**.
2. In the Type list, select **Wallpaper (Simple)**.
3. Select a projector orientation.
4. In the Setup list, select a grid layout.
The options in this menu vary depending on the number of projectors in an installation.
5. In the Content Overlap area, enter the horizontal and vertical blend overlap widths in percentages or pixels.
If connected to a Pandoras Box Manager, the content overlap values must be entered in percentages. Verify the percentage values entered in Christie Mystique align with the channel extent values entered in Pandoras Box.
6. To further inset the projected image, specify the inset percentage values.
A positive inset value creates a black border around the final full image.
7. To make changes to any of the channel extents, select **Push Layouts to Wallpaper Advanced**.

Defining an advanced layout

If the projector layout is complex, or if content spacing is not uniform across the configuration, select Wallpaper (Advanced).

The Wallpaper (Advanced) layout is intended for use with multi-camera installations.

1. In the left pane, select **Layout**.
2. In the Type list, select **Wallpaper (Advanced)**.

3. In the Projector Orientation list, select a projector orientation.
4. Enter the channel extents for each channel in screen-relative percentages.

If connected to a Pandoras Box Manager, the percentage values entered in Christie Mystique must align with the channel extent values entered in Pandoras Box.

To slightly overshoot a screen, set the percentages below 0% or above 100%. This causes the channel to project past the screen boundary.

Defining the fields of view

When selecting the Fields of View layout, specify the angular extents of each channel by Heading and by Field of View.

You can also specify a non-zero eye point.

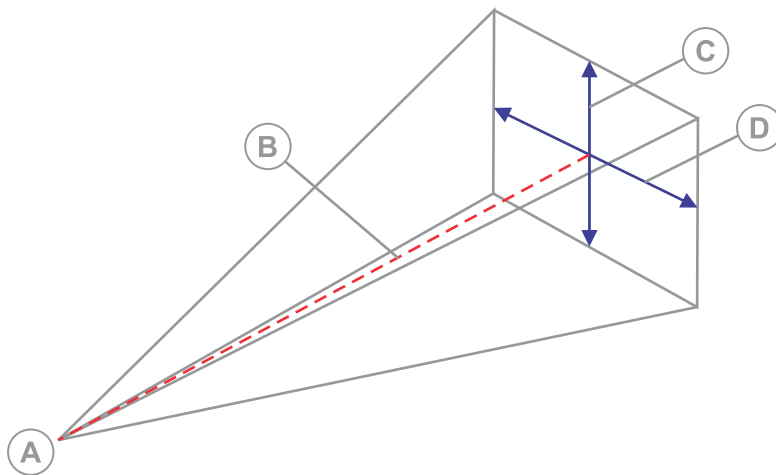

A	Eyepoint
B	Heading
C	Vertical Field of View
D	Horizontal Field of View

1. In the left pane, select **Layout**.
2. In the Type list, select **Fields of View**.
3. In the Eye Point table, enter the offset from the default center eye point.
 - For planar screens, the default eye point is in the middle of the screen.
 - For cylindrical or spherical screens, the default eye point is in the center of the curvature.
 - For custom screens, the custom screen definitions determine the x, y, and z offsets.
4. For each channel in the Fields of View Channel Extents table, adjust the yaw, pitch, roll, and FOV (field of view) settings as required.
 - **Yaw**—The angle of rotation about the Z-axis, describing the left-to-right direction of the heading of the channel. Forward headings have a yaw of 0, headings to the right are positive, and headings to the left are negative.

- **Pitch**—The angle of rotation up towards the Z-axis, describing the up-to-down direction of the heading of the channel. Horizontal headings have a pitch of 0, headings up towards the Z-axis are positive, and downward headings are negative.
- **Roll**—The angle of rotation of the channel about the heading direction (specified by yaw and pitch). A channel with no rotation about the heading has a roll of 0, channels with clockwise rotation have positive roll, and channels with counter-clockwise rotations are negative.
- **Left FOV**—The angle at the eyepoint from the channel heading to the left edge of the channel. Angles toward the left are negative.
- **Right FOV**—The angle at the eyepoint from the channel heading to the right edge of the channel. Angles toward the right are positive.
- **Top FOV**—The angle at the eyepoint from the channel heading to the top edge of the channel. Upward angles are positive.
- **Bottom FOV**—The angle at the eyepoint from the channel heading to the bottom edge of the channel. Downward angles are negative.

Changing the values in the Fields of View Channel Extents table

Change the settings for the Fields of View Channel Extents table by copying them to a spreadsheet application, modifying them, and then pasting them back in to the table.

1. In the Fields of View Channel Extents table, use the cursor keys or drag the mouse to select several cells.
2. Select **Copy**.
3. Paste the cells in to a spreadsheet application.
4. Change the values.
5. Copy the cells from the spreadsheet.
6. In Mystique, select the upper-left corner of the cell grid to paste into, and then select **Paste**.

Defining the collimated fields of view

Specify the parameters for the collimated fields of view projection.

The collimated fields of view projects the field of view data on to a mirror which the viewer can see. In addition to the settings required for fields of view data, other parameters for collimated projection, such as the position of the mirror relative to the screen and the radius of the mirror must be specified.

1. In the left pane, select **Layout**.
2. In the Type list, select **Fields of View (Collimated)**.
3. For each channel in the Fields of View (Collimated) Channel Extents table, adjust the yaw, pitch, roll, and FOV (field of view) settings as required.
 - **Yaw**—The angle of rotation about the Z-axis, describing the left-to-right direction of the heading of the channel. Forward headings have a yaw of 0, headings to the right are positive, and headings to the left are negative.
 - **Pitch**—The angle of rotation up towards the Z-axis, describing the up-to-down direction of the heading of the channel. Horizontal headings have a pitch of 0, headings up towards the Z-axis are positive, and downward headings are negative.
 - **Roll**—The angle of rotation of the channel about the heading direction (specified by yaw and pitch). A channel with no rotation about the heading has a roll of 0, channels with

clockwise rotation have positive roll, and channels with counter-clockwise rotations are negative.

- **Left FOV**—The angle at the eyepoint from the channel heading to the left edge of the channel. Angles toward the left are negative.
 - **Right FOV**—The angle at the eyepoint from the channel heading to the right edge of the channel. Angles toward the right are positive.
 - **Top FOV**—The angle at the eyepoint from the channel heading to the top edge of the channel. Upward angles are positive.
 - **Bottom FOV**—The angle at the eyepoint from the channel heading to the bottom edge of the channel. Downward angles are negative.
4. In the Eye Point Offset From Mirror Center Point table, specify the X, Y, and Z offset values from the mirror.
 5. Specify the **Mirror Location** settings, the radius, the yaw, the pitch, and the roll.
 6. If necessary, correct any distortion you see.

Correcting distortion

Use distortion correction to correct small errors in content positioning from the eye-point perspective and to compensate for the vertical-axis sag typical of Mylar mirrors.

Before correcting the distortion, make sure all other mirror parameters are specified correctly, fine-tuned, and a calibration is complete. If distortion correction is used too early, it can result in a less accurate model of the system in Mystique.

1. Switch to the **Test Pattern** tab.
2. Select **Draw**.
3. On the projection surface, measure and then record how many degrees the actual vertical horizon line (bright red dot in the image below) is from the test pattern vertical horizon line (green line).

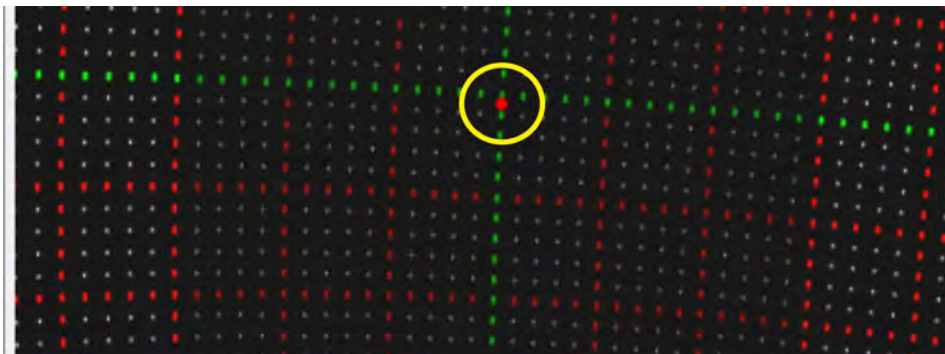

4. In the left pane, select **Layout**.
5. Select **Configure Distortion Correction**.
6. In the Pitch table, enter the original value recorded in step 3 and then enter the corrected value of 0.
There must be a space or a tab between the two values. For example, 0.5 0.
7. Repeat steps 3 to 6 for all vertical corrections.
8. Select **OK**.

Content from corrected value is mapped to the position of original value.

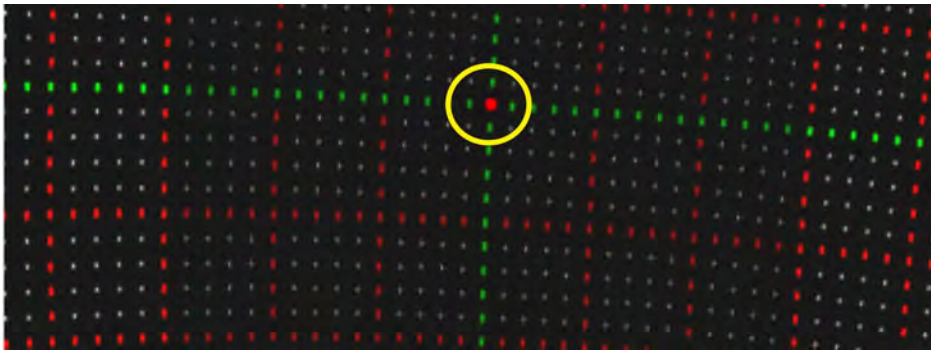

9. Recalibrate the camera.
 - a) Switch to the **Home** tab.
 - b) In the list next to Run, select **Run using gather results**.
10. To correct an error on the horizontal line, repeat steps 1 to 7, but enter the values in the Yaw table.

Related information

Running a full system calibration (on page 52)

Configuring the Projector Centric layout

Use the Projector Centric layout to display a scene with multiple viewports, and to control the area covered by each projector.

When the Projector Centric layout is selected, the eye point and angular extents for each channel must be specified.

1. In the left pane, select **Layout**.
2. In the Type list, select **Projector Centric**.
3. In the right pane, for each channel in the Projector Centric Channel Extents table, adjust the X, Y, Z axes, yaw, pitch, roll, and FOV (field of view) settings as required.
 - **X, Y, Z**—The eyepoint offset of this channel from the default eyepoint. For planar screens, the default eyepoint is in the middle of the screen. For cylindrical or spherical screens, the default eyepoint is in the center of the curvature. With custom screens, the custom screen definitions determine the X, Y, and Z offsets.
 - **Yaw**—The angle of rotation about the Z-axis, describing the left-to-right direction of the heading of the channel. Forward headings have a yaw of 0, headings to the right are positive, and headings to the left are negative.
 - **Pitch**—The angle of rotation up towards the Z-axis, describing the up-to-down direction of the heading of the channel. Horizontal headings have a pitch of 0, headings up towards the Z-axis are positive, and downward headings are negative.
 - **Roll**—The angle of rotation of the channel about the heading direction (specified by yaw and pitch). A channel with no rotation about the heading has a roll of 0, channels with clockwise rotation have positive roll, and channels with counter-clockwise rotations are negative.
 - **Left FOV**—The angle at the eyepoint from the channel heading to the left edge of the channel. Angles toward the left are negative.

- **Right FOV**—The angle at the eyepoint from the channel heading to the right edge of the channel. Angles toward the right are positive.
- **Top FOV**—The angle at the eyepoint from the channel heading to the top edge of the channel. Upward angles are positive.
- **Bottom FOV**—The angle at the eyepoint from the channel heading to the bottom edge of the channel. Downward angles are negative.

Performing a system calibration

Before beginning a calibration, verify the following:

- The screen is defined.
- The required cameras are imported, activated, and calibrated (with green calibration numbers).
- The required projectors are imported and activated.
- Channel extents are defined.
- All points are mapped.
- Camera images are focused.
- Manual exposure and threshold values are correct.
- Images are not over exposed.

Confirming the configuration

After adding and adjusting the corner points, verify the calibration is set up correctly and that the screen boundaries and channels are calibrated.

When confirming the layout of your configuration, Mystique switches to Camera View. Warping and blending is turned off, a white test pattern appears on all screens and a red bounding box is superimposed for each channel in the image. The blue bounding box represents the defined screen.

1. Switch to the **Home** tab.
2. In the Tools view, select **Confirm Layout**.
3. Verify the blue lines trace the outline of the screen and that the red lines trace where the channels should be.

If the red bounding box does not appear within the white test pattern, the image is not displayed in the target position. If the blue outline does not match the layout of the physical screen, re-calibrate the camera, adjust the horizontal and vertical overlaps, or adjust the physical or target screen parameters.

Gathering the configuration

When gathering the configuration, a mapping between the camera and the projector coordinate systems is created.

1. Switch to the **Home** tab.
2. In the Calibration view, select **Gather**.

The display area for the projectors (A), the screen area (B), and the channel areas (C) are displayed.

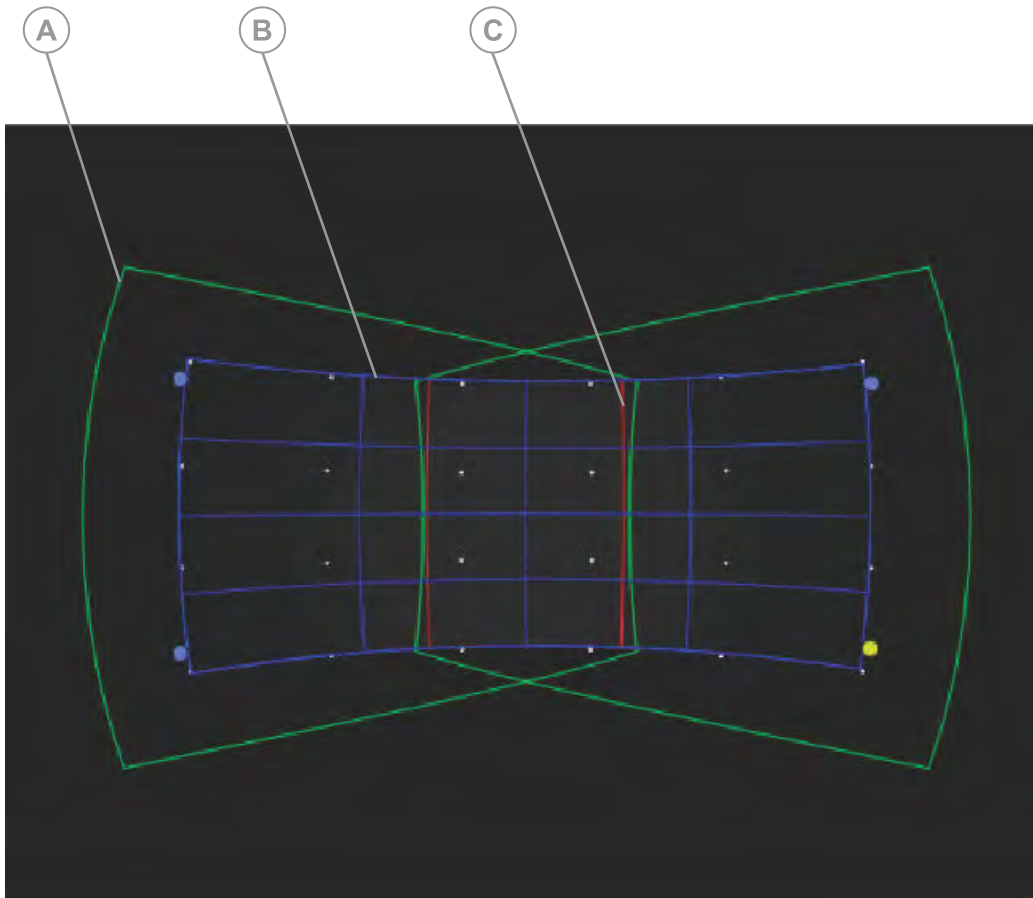

Running a full system calibration

Calibrate the cameras in a configuration.

1. To save your current configuration prior to calibrating the cameras, select **File > Save**.
2. Switch to the **Home** tab.
3. To begin a full calibration, select **Run**.
4. To configure automatic camera calibration settings, in the left pane, select **Calibration**.

Related information

Selecting calibration options (on page 53)

Running a partial system calibration

Learn how to run a partial system calibration.

1. Switch to the **Home** tab.

2. In the calibration area, select the list next to **Run** and select one of the following options:
 - **Run using gather results**—Use this option if you already confirmed the layout of a configuration or performed a full calibration, and you want to use the existing mappings between the camera and projector coordinate systems.
This option should only be used if cameras or projectors have not been moved since the last gather.
 - **Run without automatic camera calibration**—Use this option to run a faster system calibration using the existing camera calibration.

Related information

Confirming the layout of a configuration

Selecting calibration options (on page 53)

Selecting calibration options

Customize the default parameters for calibrations in a configuration.



Christie recommends only changing these options if you have an advanced understanding of Mystique or if the change is specified by a technical expert.

1. In the left pane, select **Options**.
2. Expand the **Calibration** list and modify the settings.
 - To disable Mystique from attempting to capture structured light in parallel for projectors that do not overlap, clear **Parallel Gather**. Clearing this setting may increase total gather time.
 - To automatically determine masks using information about the configuration instead of determining masks using projected patterns, select **Masks from channel data**.
 - To automatically filter the mask to reduce artifacts, select **Enable Automatic Mask Filtering**. This setting uses the default settings for Mask Closing, Remove noise smaller than, and Mask Dilation. To disable all filtering, clear this setting and set Mask Closing, Remove noise smaller than, and Mask Dilation to **0**.
 - To close holes in the mask smaller than this value, in the **Mask Closing** field, select a value for the input (in pixels).
 - To remove objects in the mask smaller than this value, in the **Remove noise smaller than** field, select a value for the input (pixels).
 - To expand masks to allow for slight movement in the system, in the **Mask Dilation** field, select a value.
 - To save the results of the last successful calibration and use them to speed up future calibrations, select **Save Reference Gather**.
The date and time of last saved gather is displayed below the button.
 - To run a quicker gather using the last saved calibration, select **Fast Gather**.
To select this option, a saved reference gather must be available.
 - To select the order of magnitude used to adjust the mathematical model to fit the collected data, in the **Fit Order** field, select a value.
Higher values should only be used for more complex situations. Change this option only if you have an advanced understanding of Mystique.

- To select the method used to generate a mathematical model to fit the collected data, in the **Fit Solver** list, select an option.
 - **Projector Centric Planar**—Recommended for use if working with projectors with standard planar lenses. (Default)
 - **Least Squares**—Recommended for use only when doing compatibility or A/B testing.
 - **RANSAC** (Random Sample Consensus)—Robust method that can be used in cases where other methods do not produce expected results.
 - **Fish Eye**—Provides improved alignment accuracy if working with projectors with f-theta lenses or if there is an especially wide field of view.
 - **Fish Eye Anamorphic**—Provides improved alignment accuracy if working with projectors with f-theta and anamorphic lenses or if there is an especially wide field of view or aspect ratio.
 - **PC Planar Anamorphic (Beta)**—Provides improved alignment accuracy if working with projectors with anamorphic lenses or if there is an especially wide aspect ratio.

Masking a projector to a screen

To apply a mask around each channel so the channel does not project past the edge of a screen, complete the following steps.

These steps can also be used to manually mask a projector or to correct brightness uniformity.



Masking options have been updated in Mystique 2.9. When loading a .cal file created by an earlier version of Mystique, the previous masking options are automatically migrated to the new options. If Mask to Screen was enabled in your .cal file, the mask layer is merged with the new screen mask when run. Christie recommends clearing the mask layer before running.

1. In the left pane, select **Options**.
2. Expand the **Calibration** list.
3. To mask a projector to the screen, choose a masking option.
 - If no mask is to be applied, leave all mask options deselected.
If the Twist file has a previously applied mask, selecting no options or **Use Masked Mappers from Twist files** erases that mask.
 - To apply a mask to the shape of the screen geometry, select **Automatically mask to screen edge**.
This writes to a dedicated screen mask layer not visible in Twist but is included with other Twist file masks if enabled, at the end of a run
If the Twist file has a previously applied mask, selecting **Use Mask Mappers from Twist file** erases that mask.
 - To retrieve brightness uniformity and masking settings, including Blend Mask, from a Twist file, select **Use Blend Mask and Mask from Twist file**.
 - To mask out calibration test patterns by the mapper mask layer in the Twist file, select **Use Mask Mappers from Twist file**.
If the Twist file has a previously applied mask, selecting this option erases that mask.

Automatically adjusting projector focus

Projector focus is typically done when a projector is initially installed. In certain cases, a projector may need to be refocused periodically due to slight projector movements or environmental conditions. Mystique, in combination with a camera, can be used to automatically focus your projector during a Mystique run.



The following projector models support automatic focus:

- Boxer Series
- Crimson Series
- D4K40-RGB
- Mirage 4K40-RGB
- Mirage SST
- Griffyn Series
- Christie M RGB Series

1. Switch to the **Home** tab.
2. In the Projector AutoFocus pane, select **Enable**.

When enabled during a Mystique run, the projector(s) is automatically focused.

Evaluating the content alignment

Learn how to enable, disable, and switch between warps and blends, and how to apply test patterns to evaluate the system quality.

Displaying a test pattern

Use test patterns to verify the Mystique setup.

1. In the left pane, select **Layout**.
2. In the Type list, select the layout.
3. Switch to the **Test Pattern** tab.
4. Configure the test pattern.

The test pattern options change depending on which layout is selected.

Wallpaper test patterns

Option	Description
Draw	Displays a test pattern on the screen.
Clear	Removes a test pattern from the screen.
Grid Density	Defines the quantity of the grid lines.
Line Color	Defines the color of the grid lines.
Fill Color	Applies a fill color to the grid test pattern.

Fields of View test patterns

Option	Description
Draw	Displays a test pattern on the screen.
Clear	Removes a test pattern from the screen.
Grid Color	Changes the color of grid points at 1°, 5°, and 90° increments.
Point Size	Changes the point size to small, medium, or large. When 1° grid points are selected, not all grid points are drawn due to a limitation on the number of grid points that can be displayed.
Fill Color	Applies a fill color to the grid test pattern.
Draw Borders	Adds borders to the test pattern.

Projector centric test patterns

Option	Description
Draw	Displays a test pattern on the screen.
Clear	Removes a test pattern from the screen.
Point Size	Changes the size of the test pattern markers to small, medium, or large.
Density	Defines how the grid markers should be used to draw the test pattern.
Grid Color	Changes the color of grid points of the grid axis (Major) and intermediate (Minor) markers.
Fill Color	Applies a fill color to the test pattern.

- To display a test pattern, select **Draw**.

Applying warps and blends to a test pattern

To see how the configuration impacts the projector, apply saved warps and blends to a test pattern.

- Select a projector.
- Switch to the **Projector Control** tab and select the warp and blend to display on the selected projector.
- Switch to the **Test Pattern** tab.
- In the Demo view, select the adjustments to apply to the test pattern.
 - Native**—Display the projector image without warps or blends.
 - Warps & Blends**—Display the configured warps and blends.
 - Warps Only**—Display only the configured warps.
 - Blends Only**—Display only the configured blends.

Adjusting a warp or blend

Adjust how warps and blends are calculated and saved to a projector.

- In the left pane, select **Options**.
- In the Warping & Blending area, enter a name for the definition.
- In the Mem Location list, select a memory location.
- To include blend calculations, select **Send Blends**.
If this checkbox is cleared, blend calculations are not completed and no blending information is sent to the projectors.
- To automatically perform brightness uniformity calculations, in the Calculate Brightness Uniformity list, select one of the following.
 - Per Channel**—Lowers brightness and contrast values one projector at a time to match other projectors in a configuration. (Recommended)
 - Global**—Takes a full image across all projectors in a configuration adjusting brightness and contrast values as required.

Accessing a saved warp

Each projector can store custom warp definitions.

1. Switch the **Projector Control** tab.
2. Select a projector.
3. In the Projector area of the ribbon, select a warp to apply.

Accessing a saved blend

Each projector can store custom blend definitions.

1. Switch the **Projector Control** tab.
2. Select a projector.
3. In the Projector area of the ribbon, select a blend to apply.

Configuring the options for Twist

To work with a Twist file in Mystique, configure the following options.

Mystique updates the name of the Twist file to match the name of the Mystique file.

1. In the left pane, select **Options**.
2. Expand the **Twist** area.
3. In the Grid Size field, specify the number of grid points you want the projector to draw during calibration.
If a grid size greater than nine is specified, the Twist file can only be opened by Twist Pro.
4. To ignore projector undershoot around the border of the screen when performing blend calculations, select **Smart Undershoot Handling**.

Creating a 3D layout

Learn how to use Mystique to display content on a 3D object, such as a building.

Before mapping a 3D object, ensure the following:

- All projectors in the 3D layout must support checks and stripes and full pixel blending.
- Each projector in the configuration must be visible by two cameras.
- A laser scan of the object is complete and accurate.
- An object (.obj) file and a point cloud data (.pcd) file for the object are complete and available for upload to Mystique.



Guardian, black level blending, color/luminance uniformity, auto focus, and electronic convergence cannot be used in 3D configurations.

Hardware requirements for 3D configurations

Understand the requirements for creating a 3D configuration.

Only the following cameras can be used with 3D configurations:

- 5.0MP Mono GigE PoE FLIR Blackfly BFLY-PGE-50S5M-C
- 5.0MP Mono GigE PoE FLIR Blackfly BFLY-PGE-50H5M-C
- 5.0MP Color Teledyne Dalsa Genie Nano C2420 G3-GC11-C2420-IF

For a list of projectors that support 3D configurations, refer to *Supported projectors* (on page 15).



Stacked projectors are not supported.

Workflows

Understand the different ways of creating and calibrating a 3D configuration.

- **Manual calibration** (on page 21)—Requires an operator to manually identify correspondences between model features in the CAD model and the same features as seen through each camera.
- **Automation controller calibration** (on page 20)—Performs a 3D calibration using an automation controller device.
- **Structured light calibration** (on page 19)—Requires minimal manipulation of known calibration data to align the model and camera.

Structured light calibration workflow for 3D layouts

Create a 3D layout by aligning the point cloud provided with the 3D model and the point cloud generated by Mystique.

1. *Add the projectors throwing light onto the surface* (on page 28).
2. Switch to the **Projector Control** tab.
3. To enhance the contrast on the projection surface, making the edges and features more visible to the cameras, select a projector and set it to use a combination of black and grey test patterns.
4. Switch to the **Install** tab.
5. *Add the cameras that can view the projection surface* (on page 32).
6. (Optional) *Manually set the exposure for the cameras* (on page 62).
7. *Select the 3D model* (on page 63).
8. Expand the Calibration pane, and select **Structured Light**.
By default, Mystique has the **Use single projector correspondences** option enabled while performing camera calibration. This allows Mystique to make a consistent camera network. If the generated point cloud is not consistent, try clearing the **Use single projector correspondences** checkbox.
9. *Configure the Structured Light settings* (on page 64).
10. *Gather the information about the scene through test patterns and projector associations* (on page 64).
11. Select **Baseline Camera Calibration**.
12. *Generate a point cloud of the scene from the projector and camera associations and the calibrations* (on page 65).
13. If the point cloud has data not relevant to the model, *remove all unnecessary points* (on page 66).
14. Align the point cloud with the model.
 - a) To change the angle of the viewport contents, right-click and adjust the orientation of the point cloud.
 - b) Select **Reorient Point Cloud**.
 - c) Select and drag three points of the camera point cloud onto the corresponding locations on the model.
15. *Align the generated point cloud with the model point cloud data*. (on page 66)
16. Evaluate how closely the scene point cloud matches the model point cloud.
The two point clouds must overlap exactly. If the matching does not appear to be exact, repeat steps 13 to 16.
17. *Determine the position of the projectors* (on page 67).
18. To verify the layout is correct, *draw a test pattern on the model* (on page 68).
If the layout must be corrected, repeat steps 13 to 18.
19. *Blend the content areas for all projectors in the configuration* (on page 68).
20. To transfer the projector and camera location information to the content system, export the calibration file.

Automation controller calibration workflow for 3D layouts

Perform a 3D calibration using an automation controller device.

1. *Add the projectors throwing light onto the surface* (on page 28).
2. Switch to the **Projector Control** tab.
3. To enhance the contrast on the projection surface, making the edges and features more visible to the cameras, set the projectors to use a combination of black and grey test patterns.
4. *Add the cameras that can view the projection surface* (on page 32).
5. (Optional) *Manually set the exposure for the cameras* (on page 62).
6. *Select the 3D model* (on page 63).
7. *Calibrate the cameras using an automation controller device* (on page 36).
8. *Gather the information about the scene through test patterns and projector associations* (on page 64).
9. *Create a point cloud of the scene from the projector and camera associations and the calibrations* (on page 65).
10. If the point cloud has data not relevant to the model, *remove all unnecessary points* (on page 66).
11. *Align the generated point cloud with the model point cloud data.* (on page 66)
12. Evaluate how closely the scene point cloud matches the model point cloud.
The two point clouds must overlap exactly. If the matching does not appear to be exact, repeat steps 11 to 13.
13. *Determine the position of the projectors* (on page 67).
14. To verify the layout is correct, *draw a test pattern on the model* (on page 68).
If the layout must be corrected, repeat steps 11 to 15.
15. *Blend the content areas for all projectors in the configuration* (on page 68).
16. To transfer the projector and camera location information to the content system, export the calibration file.

Related information

Automatically calibrating the camera using an automatic controller (on page 36)

Manual calibration workflow for 3D layouts

Manual Calibration relies on an operator finding correspondences between model features in the CAD model and the features seen through the cameras. For each correspondence, the feature must be visible by a minimum of two cameras. Six correspondences are required per camera.

Prior to each subsequent alignment, make sure the correspondences align with the marked features.

1. *Add the projectors throwing light onto the surface* (on page 28).
2. Switch to the **Projector Control** tab.
3. To enhance the contrast on the projection surface, making the edges and features more visible to the cameras, set the projectors to use a combination of black and grey test patterns.
4. *Add the cameras that can view the projection surface* (on page 32).
5. (Optional) *Manually set the exposure for the cameras* (on page 62).

6. *Select the 3D model* (on page 63).
7. *Manually calibrate the cameras* (on page 63).
8. *Gather the information about the scene through test patterns and projector associations* (on page 64).
9. *Create a point cloud of the scene from the projector and camera associations and the calibrations* (on page 65).
10. If the point cloud has data not relevant to the model, *remove all unnecessary points* (on page 66).
11. *Align the generated point cloud with the model point cloud data.* (on page 66)
12. Evaluate how closely the scene point cloud matches the model point cloud.
The two point clouds must overlap exactly. If the matching does not appear to be exact, repeat steps 11 to 13.
13. *Determine the position of the projectors* (on page 67).
14. To verify the layout is correct, *draw a test pattern on the model* (on page 68).
If the layout must be corrected, repeat steps 11 to 15.
15. *Blend the content areas for all projectors in the configuration* (on page 68).
16. To transfer the projector and camera location information to the content system, export the calibration file.

Manually adjusting camera gain and exposure

By default, camera gain and exposure are automatically adjusted by Mystique.

Adjust the gain and exposure settings until a high contrast in projected light is observed in the camera view. Before completing this task, Christie recommends setting the projector to display a high contrast test pattern, such as a grid test pattern.

1. In the left pane, select **Camera**.
2. Select a camera.
3. Expand the **Camera Exposure** area.
4. In the list, select **Manual**.
5. Do one of the following.
 - To adjust the brightness of the camera image, drag the **Gain** slider back and forth or select the - and + buttons.
 - To adjust the amount of time the camera shutter stays open when capturing images, drag the **Exposure** slider back and forth or select the - and + buttons.
 - To adjust the camera exposure to display the maximum contrast between projected white light and black, select **Show High Contrast Pattern**.
6. Repeat steps 2-5 for all cameras.

Related information

Displaying a test pattern (on page 56)

Specifying a model

Specify an object model by uploading a supported object (.obj) file and a point cloud data (.pcd) file to Mystique.

Before completing this task, verify the **PCD** view is enabled on the View tab at the top of the screen.

1. In the left pane, select **Model**.
2. To set the unit of measure, in the **Scene Units** list, select an option.
3. Under Content Model, upload the following files.
 - **Mesh**—Upload an .obj file.
The object model appears in the System View.
 - **PCD**—Upload, a .pcd file.
The point cloud appears over the object model in the System View.
4. Select the measurement units used in the content model.
5. Set the orientation so the model is facing the same direction as it appears in the content system.
If one axis is selected as Forward, the same axis (+ or -) cannot be selected as Up. The default settings are Y Forward and Z Up.
The orientation is applied to the loaded model, including both the point cloud (PCD) and Mesh (OBJ/WRL) files.

Manually calibrating cameras

Every camera in a 3D layout must be calibrated.

1. In the left pane, select **Calibration**.
2. Select **Manual Markers**.
3. Switch the view to a two-pane view, with one pane displaying the System view and the other displaying a camera view.
4. Select a camera.
5. Place markers in the System View pane.
 - a) In System View, zoom in on the model.
 - b) To add a marker point, hover the mouse pointer over an identifiable feature, select **Alt** and left-click on the feature.
 - c) To adjust the placement of a marker point, in the Screen Markers table, increase or decrease the **X**, **Y**, or **Z** values for the marker point.

A minimum of six markers must be placed, and two of the six points should be shared by each camera in a camera pair.

When adding marker points, Christie recommends adding points to identifiable features appearing on both the model in System View, and are visible to the camera in Camera View. Avoid adding markers to void spaces of the model, such as windows on a building, as these may not be clearly visible to the camera.

In some cases, angling the view upwards can help to make sure a marker point is added to the intended feature. Christie recommends avoiding coplanar points. When calibrating a 3D layout, it is beneficial for marker points to have depth.

6. Drag a marker point from System View to the corresponding feature in Camera View. Repeat this step for all markers in the Camera View.
Selected markers turn yellow.
To zoom in on the model and place markers in specific locations, select **CTRL** and scroll in with the mouse.
After at least six points have been identified on the camera view, the distance between two points on the system view is compared to the distance between the same two points on the camera view, and the accuracy of the points is analyzed.
7. To view the accuracy of the points, change to a four-pane view.
The results are displayed in the <Camera name> Calibration pane, and the accuracy is color-coded.
 - **Green**—Good match
 - **Yellow**—OK match
 - **Red**—Poor matchA camera is correctly calibrated when the dX and dY values in the Camera Calibration table are green for all marker points.
8. For any markers with red values, verify the camera view marker is as close as possible to the location of the system view marker.
To adjust the placement of a marker point in system view, select and hold **Ctrl** and move the marker point until the dX and dY values for the marker point turn green.
In rare cases, a marker point may appear to be on a feature, but the dX and dY values are not green. Or, the dX and dY values turn green when a marker point is not on a feature. If this occurs, adjust the marker point until it appears correctly on the feature in the System View.
If the marker calibration cannot be improved, the model file or laser scan may be inaccurate.
9. Repeat steps 4 to 8 for each camera in the 3D layout.

Configuring and gathering structured light

To map projector pixels to camera pixels, perform the Gather operation.

Camera images are gathered for each stereo pair.

1. In the left pane, select **Options > Gather Structured Light** and modify the settings as needed.
 - **Parallel Gather**—Captures structured light in parallel for projectors not overlapping (to reduce overall gather time). Enabled by default.
 - **Collect Inverses**—If elements in the configuration move while light is being gathered, increase the bit plane collection.
 - **Structured Light Patterns to Skip**—Select the number of bit planes the cameras should skip when gathering structured light.
 - **Collect using Camera pairs**—For each projector, specify the pair of cameras that will collect data (useful when some cameras have an incomplete or off angle view of the projector output). This option cannot be used with Structured Light camera calibration.
 - **Camera Collection Threshold**—The percentage of pixels the camera must use to identify the output of a projector. If the camera is using fewer pixels, the data from the camera is excluded from the calculation. This is only available when Collect using Camera pairs is disabled.

- **Use Mask for Auto Exposure**—Enable if there are bright lights or areas outside the 3D projection surface and inside the camera view causing incorrect auto exposure.
 - **Enable Automatic Mask Filtering**—Automatically filter the mask to reduce artifacts. Uses the default settings for Mask Closing, Remove noise smaller than, and Mask Dilation. To disable all filtering, clear this setting and set Mask Closing, Remove noise smaller than, and Mask Dilation to **0**.
 - **Mask Closing**—Close holes in the mask smaller than this value. Input is in pixels.
 - **Remove noise smaller than**—Remove objects in the mask smaller than this value. Input is in pixels.
 - **Mask Dilation**—Expand masks to allow for slight movement in the system.
2. Switch to the **Install** tab.
 3. Select **Gather**.
When the Gather operation is complete, a verification test pattern is displayed by all projectors in the layout.
 4. After performing a Gather operation, assess the results.

Test pattern	Description
Solid green	Both cameras in a stereo pair are in agreement and can see the pixels coming from a projector.
Yellow point	A pixel was visible by only one camera in a stereo pair.
Magenta	A pixel was not seen at all by the cameras in a stereo pair.
Green and magenta checkerboard	The camera to projector pixel mapping does not line up and the Gather operation was unsuccessful.

Generating the point cloud

Generate a point cloud of 3D points on the projection surface using the camera-projector correspondences collected in the Gather operation and the camera calibration values.

1. After successfully executing the Gather operation, select **Options > Generate Point Cloud** and modify the settings as necessary.
2. To manually override point generation threshold clear the **Enable Automatic Noise Filtering** checkbox.
The Override FM Threshold number field and Use Generated Threshold button are displayed:
 - **Override FM Threshold**—Set a new threshold to use as the maximum error allowed during point cloud generation per point.
 - **Use Generated Threshold**—Use the last automatically generated threshold as the new manual threshold. If the user has not performed point cloud generation previously, this sets the value to 0.
3. Switch to the **View** tab.
4. Select how to color the point cloud.
 - **Faces**—The point cloud appears in multiple colors. All points of a single color are facing the same direction.
 - **Distance**—The points touching the model are green, farther away are yellow then orange then red. Anything farther than a threshold value is red.

The threshold can be set using a number field beside the list. The default is to use the crop distance but you can set it to any value. Use the button beside the number field to set it to the cropping distance and the second button to set it to the point fit distance (which are both values in the Options panel). This helps visualize what points would be cropped if the point cloud was cropped.

- **Projectors**—The point cloud is generated from the projected light patterns. Each point knows which projector it was generated from. In this mode the points are colored orange for projectors unselected in the projector list and cyan for selected projectors. This can help determine which projector is generating bad data, if the point cloud is not aligning well.
5. If the point cloud is difficult to see, adjust the size of the points in the cloud.
 - To make the points larger, select **ALT+SHIFT** and scroll up with the mouse wheel.
 - To make the points smaller, select **ALT+SHIFT** and scroll down with the mouse wheel.

Cropping points from the point cloud

After generating the point cloud, if the cloud does not match the .pcd file, crop unnecessary points from around the object, increasing the success of automatic alignment.

If the Generate Point Cloud operation resulted in the point cloud not appearing on the model, perform the Locate operation before cropping the point cloud.

1. Switch to the **View** tab.
2. To view the .pcd file in System View, select **PCD**.
3. In the left pane, select **Options > Locate**.
4. In the Cropping Distance field, enter the radius in meters around the object. Any points outside of this distance will be removed.
5. Switch to the **Install** tab.
6. Select **Crop Point Cloud**.
7. Repeat steps 1-6 until the point cloud matches the .pcd file.
If the point cloud is cropped too much, to recover the original point cloud select **Generate Point Cloud**.

Related information

Locating the model (on page 66)

Locating the model

Automatically move the generated point cloud on to the model, and align it with the .pcd.

Each time this operation is executed, the point cloud is moved. This operation may be executed repeatedly until the results appear as expected.

1. In the left pane, select **Options > Locate** and modify the settings as needed.
 - **Cropping Distance**—Points that are beyond the distance entered in this field are discarded.
 - **Point Fit Distance**—Points that fall within the distance entered in this field are fitted to the model. The calculation is approximately $\sqrt{\text{model size in meters}}/100$. For

example, for an 80 meter building, the calculation would be $\sqrt{80}/100 = 0.089\text{m}$ (~9cm). The default distance is 5 cm.

- **Number Of Points To Fit**—The number of points that are used to establish a point cloud fit to the model. The calculation is approximately $10,000 * (\text{number of projectors})$. The default value is 10,000.
 - **Adjust Scale**—Helps to determine the scale factor of the model.
2. Switch to the **Install** tab.
 3. Select **Locate Model**.
 4. Repeat step 3 as necessary.

Related information

Cropping points from the point cloud (on page 66)

Solving the layout

Determine the positions of the projectors in a 3D layout.

1. Select **Options > Solve**.
2. In the **MPCDI** field, select a file.
for more details, refer to *Configuring Mystique Operate to work with an external MPCDI media server* (on page 91).
3. Switch to the **Install** tab.
4. To export the file to a media server, select **Solve**.

Exporting a 3D layout

If the content system does not receive the configuration details after Solve, manually enter the parameters of the configuration.

1. Switch to the **Install** tab.
2. Select **Export Dialog**.
3. In the Solved Projector Positions dialog, in the **Format** list, select a content system.
4. Copy the values from the dialog, and paste them into the content system.

Drawing a gather results test pattern

To verify the results of the successful gather, redraw the gather results test pattern on the object.

1. Switch to the **Install** tab.
2. Select **Draw Gather Test Pattern**.
3. Assess the results on the object.
 - Green pixels have been observed by at least two cameras.
 - Yellow pixels have been observed by one camera.
 - Pink pixels have not been observed by any cameras.

Drawing a 3D test pattern

To verify the accuracy of the layout after running Solve, draw a 3D test pattern on the object.

1. Switch to the **Install** tab.
2. Select **Draw 3D Test Pattern**.
3. Assess the results on the object.

If the alignment results are not as expected, try any of the following.

- Review the orientation and fit of the point cloud, and run the camera calibration again. If alignment results are still not as expected, the model used may not be an accurate representation of the object.
- Separate the model in to sections and align each section individually.

4. To remove the test pattern, select **Clear Test Pattern**.

Applying blends to a 3D layout

Blends apply a mask that can hide minor misalignments in a layout.



Black level blending cannot be used in 3D configurations.

1. Select **Options > Blend** and modify the settings as needed.
 - **Blend Options:**
 - Normal—Includes Masking and Best Angle. Useful in most situations. It prioritizes projector light that hits the surface at an angle close to 90 degrees.
 - Flat—Includes Masking. Useful when you want all projectors to contribute equally in overlap areas.
 - Edge Reduction—Includes Masking, Best Angle, and Shadow Correction. Useful when the projection surface has internal shadows (such as, a projection surface in front of another surface). Note this mode is time consuming.
 - **Blend Name**—The name of a blend.
 - **Blend Location**—The memory location of the blend on a projector.
 - **Mask Width**—The width of the edge mask.
2. Switch to the **Install** tab.
3. Select **Apply Blends**.

Blend data, such as which area of light is owned by one projector or shared by more than one projector, can be obtained in the blend.bmp file that is a part of the log files for the layout.
4. To clear blends from the layout, select **Clear Blends**.

Recalibrating a 3D layout

After a full calibration has been completed, if a hardware component moves, a recalibration will be required.

The method for recalibrating a configuration depends on the original method of calibration.

For **Automation Controller calibrations**, if the markers are still in place on the 3D object, perform the calibration with the automatic controller device again.

For **Manual calibrations** and **Structured Light calibrations**, the configuration files save the reference positions for all cameras. If the cameras have been moved too far from the saved position, a recalibration is required. To recalibrate the configuration, perform the steps below.

1. Load the calibration file.
2. (Optional) On the Home tab, select **Run Options** and select the functions of the calibration to run during the recalibration, and set any options associated with those functions.
To clear the test patterns and allow the media server content to play through the projectors, select **Show Content**.
3. Select **Run**.

Related information

Generating the point cloud (on page 65)

Cropping points from the point cloud (on page 66)

Drawing a 3D test pattern (on page 68)

Applying blends to a 3D layout (on page 68)

Configuring black level blending

To reduce the visibility of projector overlaps when displaying extremely dark content, blend the black level light of multiple projectors.

Black level blending prerequisites

Before trying a black level blend, make sure the following settings and options are in place:

- The projectors needing black level blending are the same model of projector.
- In the left pane, under Options, select **Options > Fit Solver > Projector Centric Planar**.
- Make sure the alignment quality of the warps in the configuration are excellent. If warps are not perfect or nearly perfect, black level calculations are not successful.
- Make sure the projectors in the configuration are both power and color balanced.
- If one or more projectors in a configuration uses a fish eye lens, verify all pixels of the digital micromirror device (DMD) are covered by the lens. If any are not covered, replace the fish eye lens with a planar lens.

Black level blending restrictions

- To use black level blending with the Essentials or Pro Venue editions of Mystique, contact your Christie sales representative.
- Only 2D setups with the required license/edition support black level blending; 3D layouts do not support black level blending.
- Christie recommends only doing black level blending when all the projectors are the same model as mixing different projector models is unlikely to achieve uniform black levels.

Loading a previously saved black level blend

Learn how to view a saved black level blend.

A black level blend applies to all projectors in a configuration. Up to four black level blends can be stored in Mystique.

1. Switch to the **Black Level Blending** tab.
2. Expand the **Black Level Blend** list and select a blend.
3. Select **Render Black Level**.

Correcting black level tinting

Add color to match the colors of one projector to the other projectors in the configuration. Having all the projectors in the configuration with the same color helps to make the black levels less noticeable.

For example, to correct a slightly green black level, you can add red and blue to bring it back to grey. Or for example, all the projectors in a configuration but one are slightly tinted purple. You can tint the projector to be purple to match the other projectors.



Christie recommends correcting the tinting before estimating black levels as it is easier when the projectors are already the same color.

1. In the left pane, select **Black Level Blending**.
2. Select **Enable Black Level**.
3. Under Black Levels, select a projector and modify the red, green and blue tint levels.
4. To view the Tint applied to that projector, select **Show**.

Estimating projector black levels

To estimate the black level value of a projector, use the black level projector preview.

Each projector in a configuration has a different black level light value, relative to the white value of the projector. To create a black level blend, estimate the black level for each individual projector in the configuration.

In some cases, when previewing black level values artifacts appear on the projection surface. These artifacts do not appear when final black level blends are applied.

1. In the left pane, select **Black Level Blending**.
2. Select **Enable Black Level**.
3. Under Black Levels, select a projector and select **Preview**.
4. On the projection surface, examine the exterior edges of the overlaps for the projector.
5. Complete the following.
 - If the adjacent projectors are brighter than the edges of the projector you are previewing, under **Black Level (%)**, decrease the black level contribution value for the projector.



- If the adjacent projectors are darker than the edges of the projector you are previewing, under **Black Level (%)**, increase the black level contribution value for the current projector.



6. Repeat steps 2-5 until the edges of the projector overlaps disappear.



7. Repeat this process for all projectors in the configuration.

Evaluating overall uniformity

The black levels for each projector in a configuration must be estimated before evaluating the overall uniformity of a black level blend.

1. Switch to the **Black Level Blending** tab and select **Enable Black Level**.
2. In the Black Level Method list, select **Uniform Blend**.
3. Select **Render Black Level**.
4. To fine-tune the adjustments, try any of the following.
 - In the Black Levels view, under Black Level (%), adjust the contribution value for the projectors.

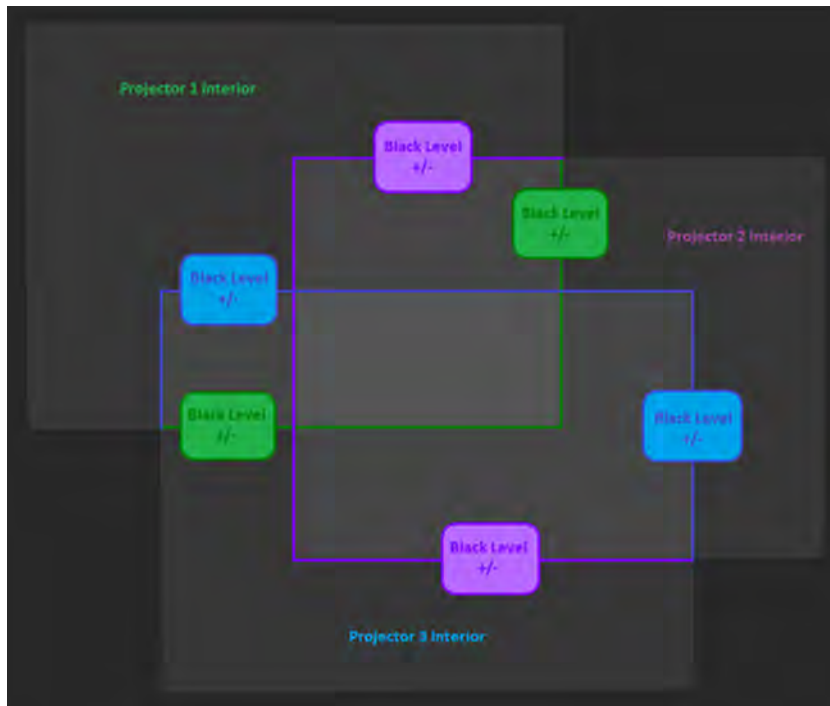

- If a gap or an overlap on an edge exists, in the Black Levels view, adjust the **Pond of Mirrors** value for the edge.

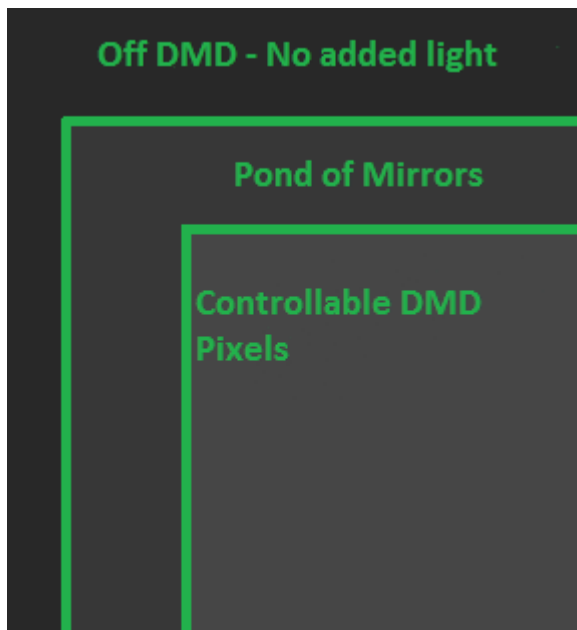

- If a specific projector appears too bright, in the Black Levels view, lower the boost factor value.

- If a specific projector appears too dark, in the Black Levels view, increase the boost factor value.

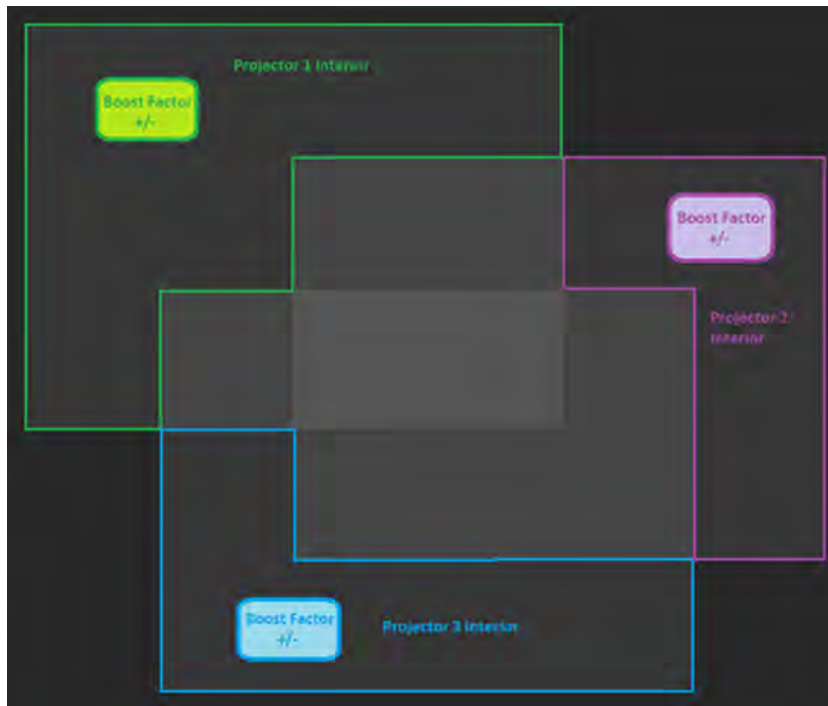

5. Select **Render Black Level**.

Adjusting the quality of a black level blend

After adjusting the correctness of the blend using the black level, pond of mirrors, and boost factor values, finalize the blend by modifying its appearance.

The perception of blend quality can change based on the viewing angle and distance from the projection surface. Christie recommends evaluating the quality of the blend from a perspective as close to the viewpoint of the audience as possible.

To achieve a final blend result, and to preserve contrast without highlighting the areas of change, complete the following steps.

1. Select **Black Level Blending**.
2. Select the Black Level Method.
 - **Uniform Blend**—Attempts to completely mask black levels across the projection surface.
 - **Influential Blend**—Applies a blend based on the largest nearby intensity change for an overlap region.
 - **Cumulative Blend**—Applies a blend based on the combined influence of all nearby overlap regions.

Influential and Cumulative blends require a Black Level Drop Off value.

3. To add additional light to overlap regions between projectors in a configuration, adjust the **Added Black Light** value.

Adding black light can help to disguise intensity or color transition and balances the black level blends.

4. To match intensity levels between projectors in a configuration and blur overlap zones into the non-overlap zones, increase the amount of light used across a black level blend by adjusting the **Black Level Drop Off** value.

This value is measured in the unit of distance of the projection surface. Increasing this value can help in situations where projectors are difficult to balance, are improperly color matched, or where there are warp inaccuracies.

5. Select **Render Black Level**.

If you switch between black level methods, it might be necessary to adjust the black level and boost values. A set of values that appears well balanced in one method might require adjustments to appear well balanced in another method.

Saving a black level blend

Save up to four black level blends for later reference. A black level blend applies to all projectors in a configuration.

1. In the left pane, select **Options**.
2. In the Warping & Blending area, in the Name field, enter a name.
3. In the Mem Location list, select a memory location.
4. To include blend calculations, select **Enable Blending**.
5. To save a black level blend, select **Home > Run**.

Maintaining the alignment of a projected image with Guardian

Configure Guardian to gather and perform calibration of live content and monitor projector positioning to make sure the content is always aligned.

Guardian functionality is only available with the Guardian add-on to the Essentials and Pro-Venue editions of Mystique. To purchase the Guardian add-on, contact your Christie sales representative.

Guardian supports both flat and curved screens. Only single-camera configurations are supported, and the camera must be able to see the entire screen.



Guardian does not work for 3D configurations or image-based alignment. Guardian is only supported on Windows 10 and 11 operating systems.

If the camera drifts off its alignment, projector content also drifts. Alignment between projectors is maintained but alignment to the screen itself drifts. To avoid vibration or drift, mount the cameras.

Guardian is only supported on Windows 10 and 11.

Guardian requirements and limitations

Understand the requirements and limitations for systems to run Guardian.

Hardware requirements

Only the following cameras can be used with Guardian:

- 5.0MP Mono GigE PoE FLIR Blackfly BFLY-PGE-50S5M-C

Guardian is supported on the following projectors:

Projector	Main software version	Guardian	
Boxer	2K20	1.7 or later	Supported
	2K30	1.7 or later	Supported
	4K20	1.6 or later	Supported
	4K30	1.6 or later	Supported
	Mirage 304K	1.6 or later	Supported
Crimson Series	1.1 or later	Supported	
D4K40-RGB	1.2.0 or later	Supported	

Projector	Main software version	Guardian
Mirage 4K40-RGB	1.2.0 or later	Supported
Mirage SST	1.0.1 or later	Supported
Griffyn Series	1.2.0 or later	Supported
Christie M RGB Series*	1.0.0 or later	Supported

* Guardian is not supported with the Christie M RGB Series when in Shifted Superposition mode. Refer to the *TruLife+ User guide (P/N: 020-103315-XX)* to disable this setting to use with Guardian.



Make sure the projectors are running the latest firmware.

Additional requirements:

- All projectors in system must be the same model.
- All projectors in system must have the same model and revision of input card, and the cards must be installed in the same slot.
- The GPIO camera trigger cable (P/N: 156-133108-XX) must be connected between one of the projectors in system and the camera.

System requirements

- The network must be only used for Mystique, including only the camera, projectors, and Mystique computer. Do not include Pandoras Box servers or other network devices on the Mystique network.
- The camera requires a Power over Ethernet (PoE) switch or injector.
- Do not use more than a single switch between devices.
- Christie recommends a minimum screen brightness of 2 ft-L for best results.
- Before running a Guardian calibration for the first time, the camera lens' manual aperture should be set wide open (or to the lowest f-stop).
- Guardian is only supported on Windows 10 and 11
- For multiple projectors, content output signal timings must match and be synchronized (frame-locked) for Guardian to work. Run between 50Hz and 60Hz, or run at 120Hz.

Content recommendations

- Guardian can only monitor and correct alignment during periods of bright content. Correcting alignment requires an approximate brightness greater than ~30% in at least one of three color channels (specifically greater than 72 out of 255) for a period of at least 30 seconds per projector.
- Guardian can only calibrate when there is a signal to the projector. If no signal is present, visible structured light patterns have to be used.

Configuring and starting a Guardian calibration

Configure Guardian so if it is determined that the position of a projector has moved, the content is automatically adjusted and realigned. This process is invisible to anyone viewing the content.

1. Set up the configuration, including the screen and all projectors and cameras, and perform a smooth screen calibration.

This ensures the configuration is correct and saves a reference gather which can be used with the Fast Gather feature. Christie expects that good warps and blends have been uploaded to all projectors before beginning the Guardian calibration steps.

2. Connect the Guardian GPIO cable between the projector and camera.
3. On the Home tab, select **Guardian Health**.



Running Guardian Health will interrupt the content and display light on the screen.

All the components of the configuration are checked to make sure they meet the criteria for Guardian calibration. Any issues that must be resolved are listed in the Status Viewer.

A successful Guardian configuration displays the message *System is ready for Guardian* in the Status Viewer.

4. Expand the **Options** area.
5. To make sure the generated warps contain similar geometric properties to the previously uploaded warps, in the Warping and Blending area select **Warp Validation**.
If a difference is found, the new warps are not uploaded to the projectors
6. To retry the gather on a projector if the gathered data does not cover the channel, select **Validate Gather**.
7. To speed up the gathering of data from the scene, save a Reference Gather and enable **Fast Gather**.

Christie recommends saving a reference gather from a visible light calibration.

8. In the Calibration area, select the type of **Mapper Encoding**.
 - **Default**—Recommended encoding for most configurations.
 - **Extended**—Provides redundancy during calibration for unexpected objects moving through the camera view, such as a Zamboni or an insect. Extended encoding takes a longer to complete.
9. To ignore calibration data gathered from black areas of the content, which can produce misinterpreted calibration results, select **Content Masking**.

Ignoring the data collected from black areas of content allows the calibration to be based on the areas of the content it can gather, eliminating alignment and calibration issues caused by the misinterpreted results. When enabled, if Guardian is presented with an all black frame any calibration data gathered to that point is removed and the calibration fails.

Do not use content masking if the content has frames that are completely black.

If the Content Masking checkbox is not selected, data is gathered from all areas of the content.



Christie strongly recommends against using Extended encoding and Content Masking at the same time. The combination of these settings creates a longer Gather period, providing more opportunity for black content to appear during the calibration, and a higher risk of the calibration failing.

10. Before running a Guardian calibration for the first time, the camera lens' manual aperture should be set wide open (or to the lowest f-stop).

11. To start Guardian, select **Guardian Calibration**.

When the projector enters Guardian mode, a small flicker may occur in the projected content.

Monitoring a Guardian calibration

Remotely monitor and calibrate a Guardian configuration with Mystique Operate.

For additional information on Mystique Operate, refer to the *Mystique Operate API Commands Guide* (P/N: 020-102628-XX).

Related information

Adding scenes in Mystique Operate (on page 89)

Controlling Guardian from Mystique Operate (on page 90)

Mapping a playing surface

When using the Pro Venue, Premium, or Large Scale Experience edition of Mystique, images can be projected on a playing surface, such as a basketball court or a hockey rink.

Requirements for mapping a playing surface

Before you begin an installation, make sure the following is complete.

- **Camera position**—Identify where the camera will be mounted in the facility. The camera must be in a position where it can see the entire playing surface. Christie recommends placing the camera as high as possible, for example by the broadcast booth, for the widest field of view in the camera image.
Typically, one camera is required for mapping a playing surface.
- **Projectors and projector layout**—Confirm the number of projectors required for the installation, and identify where and how they will be mounted above the playing surface.
- **Reference image**—Christie recommends using an image of the arena surface to align the projectors. The image used must match the aspect ratio of the playing surface. Any markings on the surface, such as face-off circles or goal lines, should be accurately positioned in the image. This image must be in .png format.

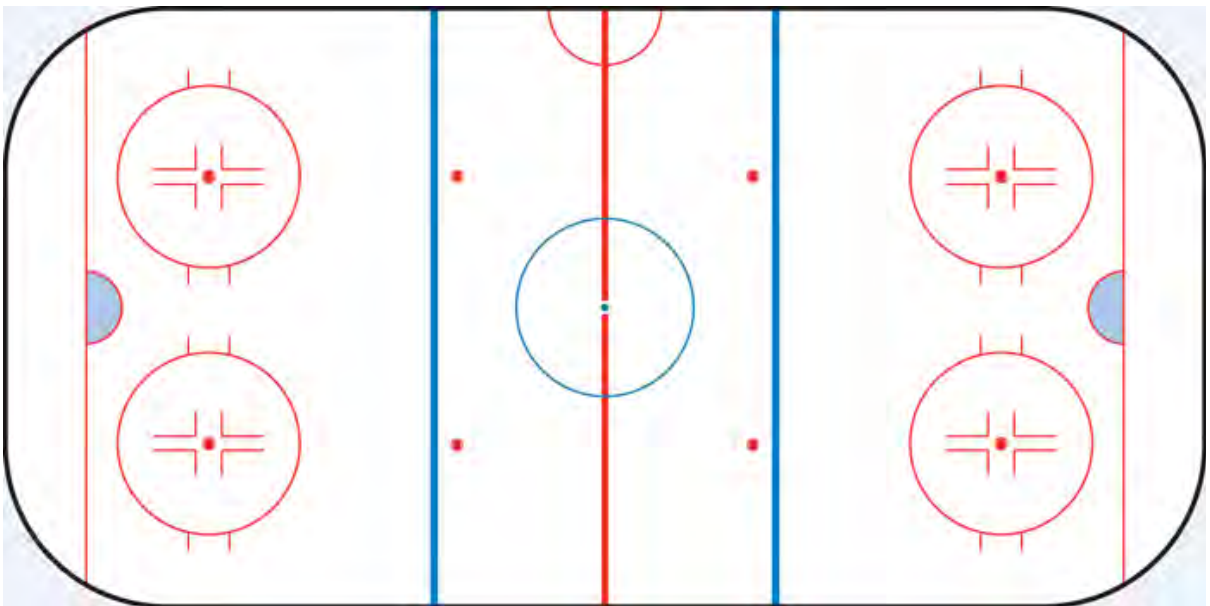

- **Media server channel information**—To complete the configuration in Mystique, you must know how the content will be sliced and sent to each projector. You must also know the projector layout and determine whether blend sizes are calculated in pixels or as a percentage.

To arrange a site survey, contact Christie Technical Support.

Adding devices to a configuration

Learn how to add a camera and projectors when mapping a playing surface.

Searching for a projector

Search by port number when adding a projector to the configuration.



The projector must be on the same subnet as the computer when searching by port number.

1. In the left pane, select **Projector**.
2. Select **Add**.
3. Select **Search**.
4. Select a projector.
5. Select **OK**.

Manually adding a projector to a configuration

If a projector is not automatically detected, or if it is not on the same subnet as other projectors in a configuration, you can manually add the projector to the configuration by entering the projector IP address and port number.

To manually add a projector to a configuration, you must know the IP address and port number of the projector. To find the IP address of a projector, refer to the projector documentation.

1. In the left pane, select **Projector**.
2. Select **Add**.
3. On the Manual tab, enter the **IP Address** and **Port** number of a projector.
4. Select **Search**.
5. Select the projector.
6. Select **OK**.

Connecting a Pandoras Box Manager as a projector

Learn how to add a Pandoras Box Manager as a projector in Mystique.

When connecting to a Pandoras Box Manager, each output in a Pandoras Box project appears as a projector in Mystique. While Mystique can connect to one Pandoras Box Manager at a time, multiple Pandoras Box clients can be connected to a single Manager.

Mystique, the Pandoras Box Manager, and all Pandoras Box Clients must be configured for, and run on, the same network.

For a blend for Pandoras Box to appear as expected, Christie recommends using projectors that can support a gamma curve of 2.2, such as Christie 3-chip DLP projectors. Otherwise, blend quality can vary.

1. In Pandoras Box Manager, verify the project file containing the content is open.

2. In Mystique, in the left pane, select **Projector**.
3. Select **Add**.
4. Do one of the following.
 - If the Pandoras Box Manager is installed on the computer used to run Mystique, from the Search Results list, select **PB Devices**.
 - If the Pandoras Box Manager is installed on another computer, or PB Devices does not appear in the Projector Search Results list, switch to the **Manual** tab. Enter the IP address of the Pandoras Box Manager, and select **Search** or **Clear & Search**. Your Pandoras Box devices should now show in the Projector Search Results list.
5. Select **OK**.

Once you connect to a Pandoras Box Manager, canvases for warping, blending, and test patterns are created in the Pandoras Box project. Establishing a consistent communication stream might take longer than expected.

When Mystique is run, warps and blends are added to the output and activated in Pandoras Box Manager.

Some projector controls, such as power and shutter controls, are unavailable when connected to a Pandoras Box Manager.

Adding a camera to a playing surface configuration

To add a camera to a configuration, complete the following steps.

1. Open or create a configuration file.
2. In the left pane, select **Camera**.
3. Select **Add**.
4. Select the camera.
5. To see a recently connected camera, select **Refresh**.
6. Select **OK**.

When a camera is added, a preview of the camera image appears in the Camera View.

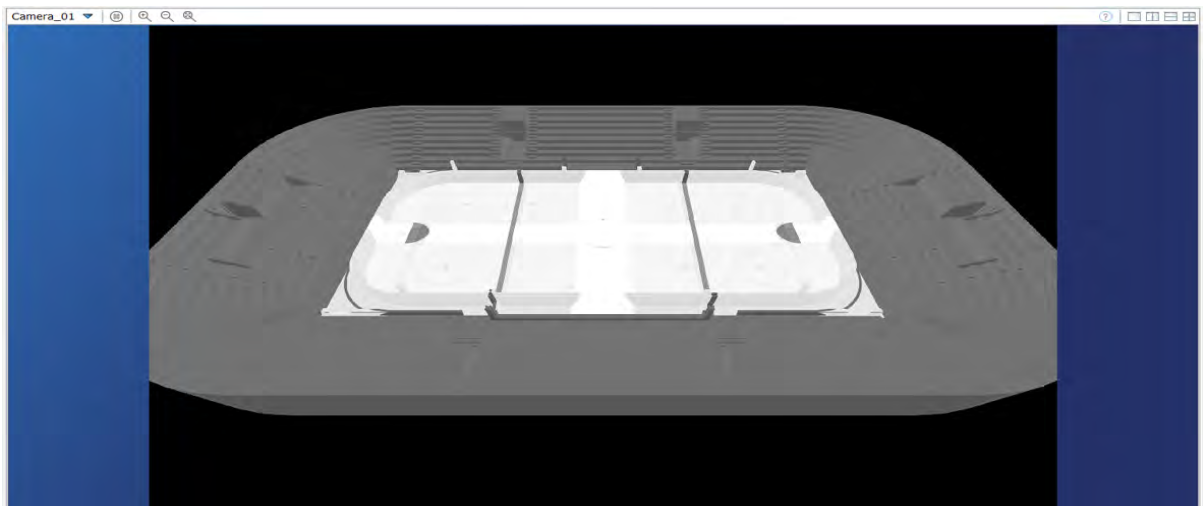

Defining the playing surface layout

A channel is a slice of content sent to a projector. When defining the layout, the location of each channel, and where the pixels land within each channel in a configuration are defined.

Values that are entered must match the parameters of the content or image generator. If a configuration includes projectors that are stacked, channel extent values must be identical for each projector in the stack.

Define the channel extents for a configuration using one of the following methods:

- Wallpaper (Simple)
- Wallpaper (Advanced)

Warps are automatically generated so the projected image matches the layout specified in Mystique.

Defining a simple layout

If using a standard projector layout, such as a 2x2 or 2x3 stacked or a simple blended layout, select Wallpaper (Simple).

Channel layouts are defined by the overlaps between adjacent channels. Once defined, the projected area of all channels fills the entire screen or playing surface.

For a multi-camera installation, use the Wallpaper (Advanced) layout.

1. In the left pane, select **Layout**.
2. In the Type list, select **Wallpaper (Simple)**.
3. Select a projector orientation.
4. In the Setup list, select a grid layout.
The options in this menu vary depending on the number of projectors in an installation.
5. In the Content Overlap area, enter the horizontal and vertical blend overlap widths in percentages or pixels.
If connected to a Pandoras Box Manager, the content overlap values must be entered in percentages. Verify the percentage values entered in Christie Mystique align with the channel extent values entered in Pandoras Box.
6. To further inset the projected image, specify the inset percentage values.
A positive inset value creates a black border around the final full image.
7. To make changes to any of the channel extents, select **Push Layouts to Wallpaper Advanced**.

Defining an advanced layout

If the projector layout is complex, or if content spacing is not uniform across the configuration, select Wallpaper (Advanced).

The Wallpaper (Advanced) layout is intended for use with multi-camera installations.

1. In the left pane, select **Layout**.
2. In the Type list, select **Wallpaper (Advanced)**.
3. In the Projector Orientation list, select a projector orientation.
4. Enter the channel extents for each channel in screen-relative percentages.

If connected to a Pandoras Box Manager, the percentage values entered in Christie Mystique must align with the channel extent values entered in Pandoras Box.

To slightly overshoot a screen, set the percentages below 0% or above 100%. This causes the channel to project past the screen boundary.

Mapping the marker points on a playing surface

Before calibrating a configuration of a playing surface, identify the features on the playing surface you want to calibrate to.

When using a reference image to align the projectors, the reference image must match the aspect ratio of the playing surface. Any markings on the surface, such as face-off circles or goal lines, should be accurately positioned in the image. This image must be in the format of a .png file.

1. In the left pane, select **Screen**.
2. In the Shape list, select **Flat**.
3. In the Determine Size list, select **From Image**.
4. In the Marked Surface Image field, browse to the reference image.
The reference image appears in the Marked Surface Image view, with marker points appearing at the corners of the image.
5. In the Marked Surface Image view, move the marker points to four features of the playing surface visible to the camera you want to calibrate to. For example, if mapping a hockey rink, you can move the marker points to the face-off circles.

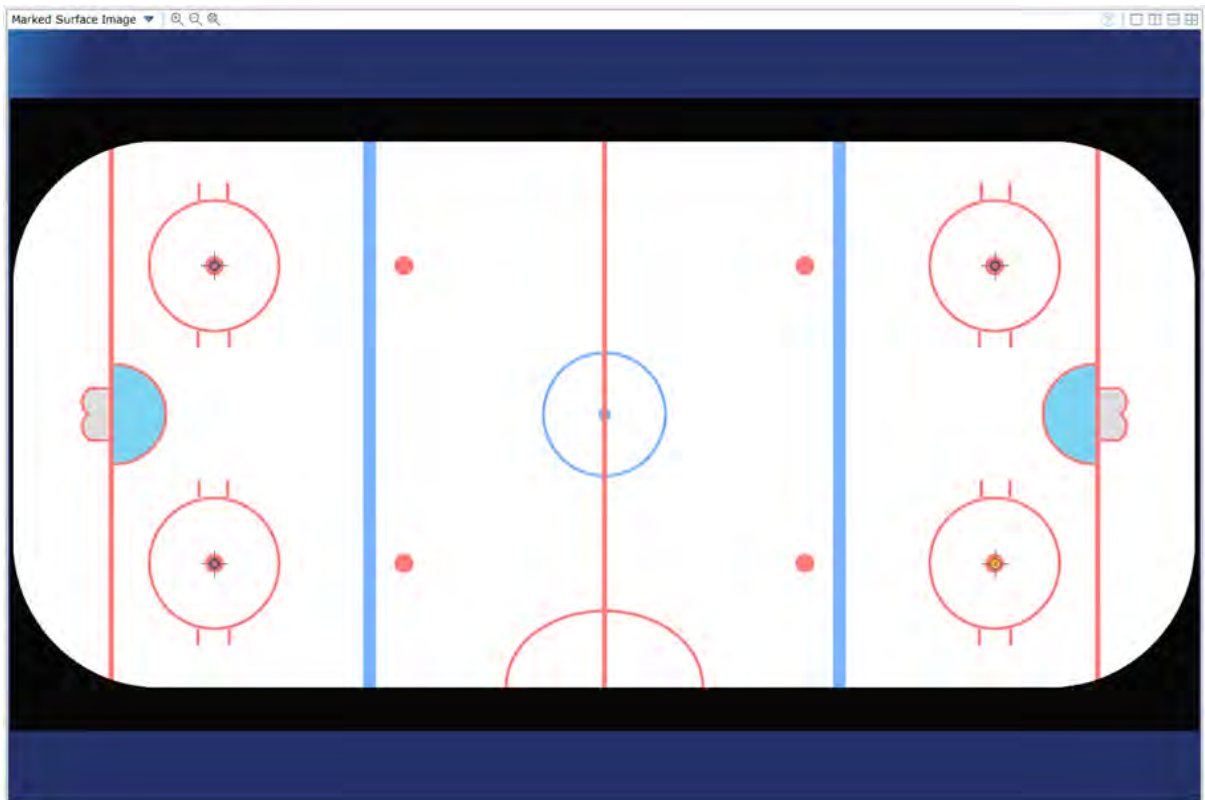

Calibrating the camera

When mapping a playing surface, match the marker points on the reference image to the corresponding points on the physical playing surface in Camera View.

Two camera calibration methods can be used.

- **Manual calibration**—When using this method, calibration data is saved as part of your .cal file; however, the calibrated camera image is not saved. If the camera is unintentionally moved out of position, the camera must be recalibrated manually using the original reference image.
- **Image-based calibration**—After calibrating the camera, using the calibrated camera image, take a new reference image. When using this method, if the camera is unintentionally moved out of position, it can automatically be recalibrated to align with this new reference image.

Calibrating a playing surface configuration manually

After mapping the marker points of a playing surface in the Marked Surface Image View, match the marker points what the camera sees in Camera View.

1. In the left pane, select **Calibration**.
The Camera View appears with a transparent overlay of the mapped reference image.
2. In the Camera View, zoom out until the marker points are visible.
3. Adjust the marker points so the transparent overlay of the reference image matches the camera image of the playing surface.
4. To increase or decrease the opacity of the transparent overlay, move the **Opacity** slider to the right or to the left.
5. To make fine adjustments to the corner points, select and hold the **CTRL** key, and move the calibration points as required.
The dX and dY values turn green when the corner points are correctly calibrated.
6. Perform a manual calibration.
 - a) Switch to the **Home** tab.
 - b) Select **Run**.The calibration data is saved as part of your .cal file, however the camera image is not saved.

Performing an image-based calibration on a playing surface

An image-based calibration may be performed if the screen size is determined using an image.

Christie recommends only performing image-based calibrations in settings where lighting conditions are consistent. If lighting conditions change between calibrations, manual camera calibration might be required.

After calibrating the camera, take a new reference image so if the camera is unintentionally moved out of position, it can automatically be recalibrated to align with the new reference image.

1. Open or create a configuration file.
2. In the left pane, select **Calibration**.
3. In the Camera View, zoom out until the marker points are visible.
4. Adjust the marker points so the transparent overlay of the reference image matches the camera image of the playing surface.

5. To increase or decrease the opacity of the transparent overlay, move the **Opacity** slider to the right or to the left.
6. To make fine adjustments to the corner points, select and hold the **CTRL** key, and move the calibration points as required.
The dX and dY values turn green when the corner points are correctly calibrated.
7. Select **Image-Based** from the list.
8. If required, do any of the following.
 - To set the camera exposure manually, clear the **Enable Auto Exposure** checkbox, and move the slider.
 - When mapping a playing surface, to mask moveable features visible to the camera that are outside of the screen and not covered by the marked surface overlay, such as non-fixed seating or advertising, select **Use Screen as Mask**. This option is available only with the Pro Venue edition of Mystique.
9. Select **Calibrate Cameras**.
10. To take a new reference image, click **Take Reference Image**.
11. Select **Run**.
Christie Mystique saves this new reference image and uses it for automatic recalibration each time you select **Run**.

Testing image-based recalibration

Validate whether a camera can be successfully recalibrated to a reference image if it is accidentally moved out of place.

To recalibrate a camera using this method, a reference image of the configuration must have been previously taken using Mystique.

Christie recommends this method of recalibration when correcting for small motions of a fixed camera, such as a building vibration. If the camera is moved to a new location or its view is significantly altered, manually realign the camera for the new configuration and take a new reference image.

1. Open a configuration file.
2. In the left pane, select **Calibration**.
3. Select **Image-Based** from the list.
4. To test recalibration of the camera, select **Calibrate Cameras (B)**.

If recalibration is successful, the alignment of the marked surface overlay matches the image in the Camera View (A). If recalibration is unsuccessful, try adjusting the exposure or enable the **Use Screen as Mask** setting.

Before

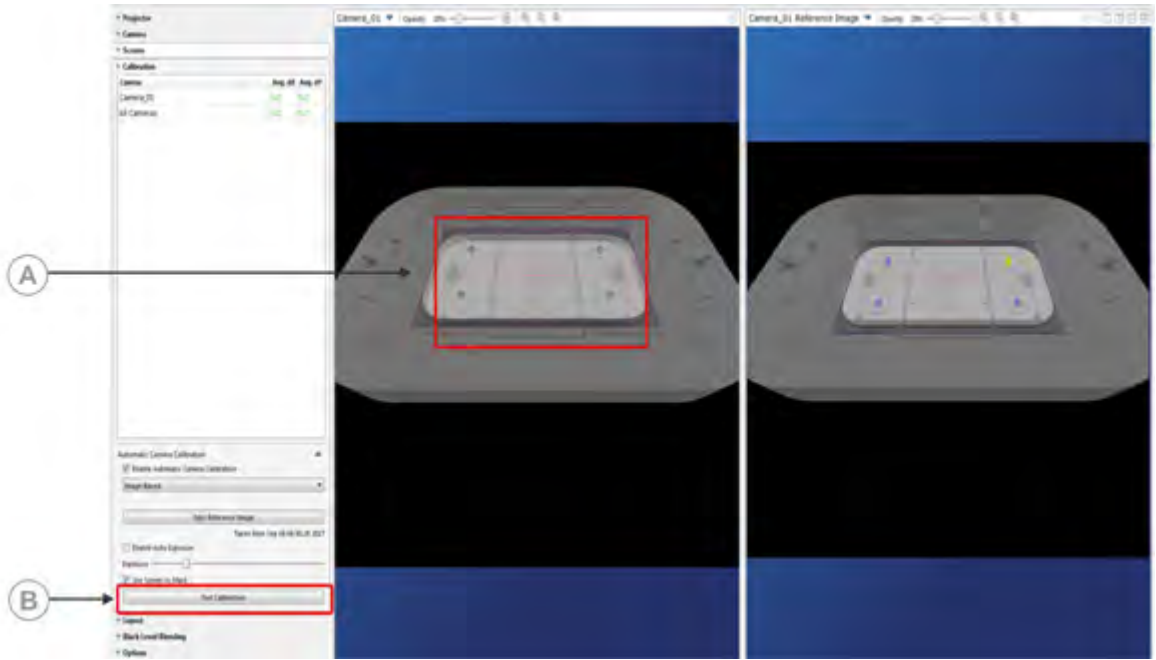

After

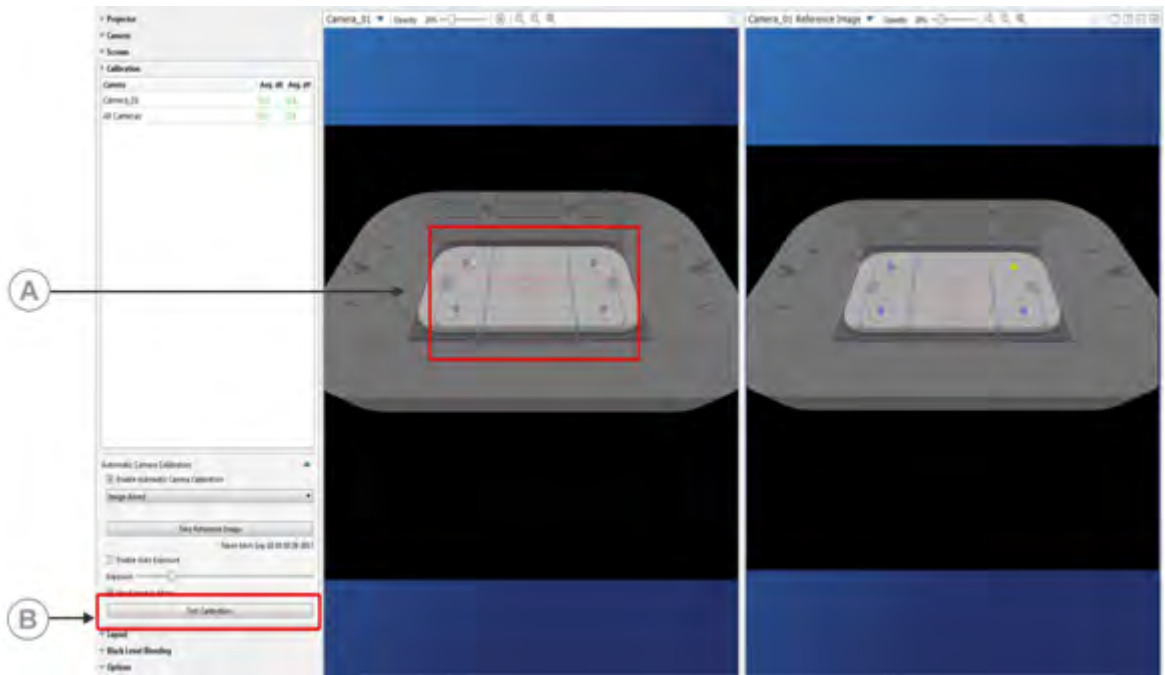

Using Christie Mystique Operate

These instructions explain how to get started with Christie Mystique Operate.

About Christie Mystique Operate

Mystique Operate provides remote management of Christie Mystique.

This allows you to control top-level features that align a projection system from a standard web browser or from a third-party application.

With Mystique Operate, you can do any of the following.

- Configure one or more Mystique scenes
- Run the calibration process for a scene
- Hide or show test patterns
- Approve or revert alignment changes

Mystique Operate also includes a REST API interface and JSON TCP/IP API that allows third-party applications to control Mystique. Refer to the *Mystique Operate API Commands Guide (P/N: 020-102628-XX)*.

Mystique Operate is intended for use by one person at a time. As Mystique Operate remotely initiates and closes Mystique, before using Mystique Operate, verify all instances of Mystique are closed on your computer.

Supported browsers

Mystique Operate supports the following browsers.

- Google Chrome™
- Microsoft® Edge®

Adding scenes in Mystique Operate

Learn how to add a scene or a list of scenes to Mystique Operate.

A scene is a single screen or surface consisting of projectors and cameras. To control alignment, each scene requires a unique Mystique .cal file.

Applications that use 3D Stereoscopic projection with independent projector channels for each eye require two .cal files—one for each eye.

1. On the Settings page, select **Add**.
2. To change the name of a scene, select the scene name.

3. In the file path field, enter the full path to the .cal file.
The .cal file must be located on the computer running Mystique Operate.
4. If required, do any of the following.
 - To reorder a scene in a list of scenes, drag and drop a scene to another place in the list.
 - To delete a scene, drag a scene to the **Trash** icon and drop it.
5. To save your settings, select **Save Changes**.
If there is an error with a scene, a message appears at the top of the screen.
6. To open the Home page, at the top of the screen select **Home**.

Navigating the Home page

To perform tasks on a scene such as adding or clearing test patterns, or running a calibration, navigate to the Home page.

To reorder a scene, return to the Settings page.

1. In the Scene list, select a scene.
2. Do any of the following.
 - To run a calibration, select **Run Calibration**.
 - To display a test pattern, select **Test Pattern**.
 - To clear a test pattern, select **Clear**.
 - To cancel your changes, select **Cancel**.
3. To save the last run calibration as a restore point, select **Approve**.
4. To restore your scene to a previous setting, in the Restore list, select a previous setting.

Controlling Guardian from Mystique Operate

To perform tasks on a Guardian scene such as starting or stopping Guardian, or running a calibration, navigate to the Home page.

1. Open Mystique Operate.
2. In the Scene list, select a Guardian scene.
3. To turn on or off the continuous Guardian monitoring, select **Guardian Protection**.
4. To run an invisible, one-time heal with Guardian calibration, select **Heal Now**.
5. To perform additional diagnostics, select **>>** and do any of the following.



Performing any of these operations will interrupt the content and display light on the screen.

- To run a calibration, select **Run Calibration**.
 - To display a test pattern, select **Test Pattern**.
 - To remove a test pattern and display the content from the input signal, select **Clear**.
6. To cancel an operation, select **Cancel**.

7. To view the status of the Guardian operation, including any failed runs or errors, review the information below the Heal Now button.

If there is a part of the content that has enough light to perform a successful Guardian calibration, use the Operate REST API to synchronize the `Heal` command to run at the correct time.

Configuring Mystique Operate to work with an external MPCDI media server

This section details how to configure a system with Mystique Operate when Mystique is set up to write MPCDI files to an external media server PC.

Configuring the media server PC

Learn how to configure the media server PC.

1. Create a new or use an existing Windows administrator user.
If creating a new account, use a meaningful username and password, for example:
 - username = Mystique
 - password = Mystique
2. Map a drive to the target MPCDI folder.
3. Make sure the user account from step 1 has write privileges to the drive mapping created in step 2.

Configure Mystique PC

Learn how to configure the Mystique PC.

1. Replicate the user account created in *Configuring the media server PC* (on page 91), using the same username and password.
In *Configuring the media server PC* (on page 91), the example username and password are Mystique and would be replicated in this step.
2. Grant the **Run as Service** permission to the user created in step 1:
 - a) Navigate to **Administrative Tools > Local Security Policy > Local Policies > User Rights Assignment**.
 - b) Right-click **Log on as service > Properties**.
 - c) Select **Add User or Group**.
 - d) In the Edit dialog, enter the Mystique user account created.
 - e) Select **Check Names**.
 - f) Select **OK** until all dialogs disappear.
3. Log into the Mystique PC with the user.
4. Map a network drive, as configured on the media server PC.
Make sure you select **Reconnect at sign in**.
5. From Mystique, confirm your **Options > Solve > MPCDI file path** is set to the mapping configured in step 4.

6. Change the **Log On As** user to the user created in step 1:
 - a) Navigate to **Administrative Tools > Services**.
 - b) Locate the **Mystique Operate Automation** service.
 - c) Right-click and select **Properties**.
 - d) Select **Log On**.
 - e) Select **This Account**.
 - f) Enter the user credentials configured in step 1.
 - g) Select **OK**.
 - h) Select **Stop Service**.
 - i) Select **Start Service**.
 - j) Confirm the Startup Type is set to **Automatic**.

Configuring Mystique Operate service to run on a different port

After installation, Mystique Operate is configured to run on port 80. If this port is used by another service on the computer, configure Mystique Operate to use a different port by adding a new system environment variable.

1. Make sure you are using an administrative user account.
2. From the keyboard, select **Windows key+R**.
3. In Run dialog, enter `systempropertiesadvanced`.
4. From the Advanced tab of the System Properties dialog, select **Environment Variables**.
5. Under System variables, select **New**.
6. In the New System Variable dialog, enter the following:
 - **Variable name:** MYSTIQUE_OPERATE_HTTP_PORT
 - **Variable value:** 80—Make sure to select a port number not in use by another service.
7. To exit the New System Variable dialog, select **OK**.
8. To exit the Environment Variables dialog, select **OK**.
9. To exit the System Properties dialog, select **OK**.
10. Reboot the computer for the new settings to take effect.

Color/luminance uniformity

When using the Mystique for 2D configurations, screen images can be calibrated to appear more uniform.

Requirements for making a uniform display

Before beginning an installation, make sure the following is complete.

- Camera position—A single camera must be placed which sees all projector pixels to be compensated. Systems equipped with a monochrome camera are physically restricted to only compensate for luminance uniformity.



Only the 5.0MP Color Teledyne Dalsa Genie Nano C2420 G3-GC11-C2420-IF camera can be used with color uniformity.

- Projectors and projector layout—Confirm the number of projectors required for the installation and they can be seen by a single camera.
- Lighting control—Confirm the lighting in the projection area cannot change during the calibration process.

Performing a 2D projector alignment

The projectors must first be aligned in a 2D configuration prior to the screen uniformity calibration being performed.

1. *Add the projectors throwing light onto the surface* (on page 28).
2. *Add the cameras that can view the projection surface* (on page 32).
3. *Define the screen space* (on page 42).
4. *Calibrate the cameras* (on page 36).
5. *Set the type of layout and the projector orientation* (on page 45).
6. *Run a full system calibration on the configuration* (on page 51).
7. *Create or adjust any blends or warps on the projected image* (on page 56).

Color uniformity workflow for 2D layouts

To make projectors in a 2D configuration appear more uniform, perform these steps.

1. *Configure a 2D layout* (on page 19).
2. *Run a full system calibration on the configuration* (on page 52).

3. From the Color/Luminance uniformity tab, enable and configure your color calibration options.
4. To run a color calibration, make sure the **Enable Uniformity Correction** checkbox is selected and select **Run** in the ribbon.
5. Review the result on the screen to see if adjustments are needed.
Reduce compensation by using the slider on the Color/Luminance Uniformity tab.
6. If additional refinements are required, from the Color/Luminance Uniformity tab, select **Advanced** and make adjustments based on the histogram to ignore outlying areas of luminosity.
7. To apply the adjusted settings, from the Color tab, select **Send Adjustments to all Projectors**.

Adjusting Uniformity settings

If the default settings for the screen uniformity calibration must be adjusted, they are available in the Color/Brightness Uniformity configuration panel on the left of the Mystique window.

Configuration parameters

Parameter	Description
Enable Uniformity Correction	Causes Color/Luminance Uniformity to be run as part of a Run, after geometric alignment.
Uniformity Correction	Selects whether a projector configuration should be adjusted for only luminance or for both luminance and color.
Compensation Amount	Indicates the maximum percentage of permitted luminance loss that Mystique may use to compensate with. 100% compensation yields most uniform results. 0% compensation uses maximum luminance to project uncompensated images.
Compensation Amount slider	Presents an additional way to indicate the Compensation Amount.
Advanced	Provides fine-tuning ability for blends.
Pixel Luminance Distribution Histogram	Shows the pixel luminance distribution, to get an understanding for how bright/dark the pixels are. A user can choose to not compensate certain bad pixels. The histogram is populated after a color calibration is performed.
Compensation Range slider and spin boxes	Shows the bounds of pixel intensities to be compensated. If pixels are too shiny (bright) or too dark (black), they can be excluded by sliding the right and left bounds of the sliders respectively.
Send Adjustments To All Projectors	Recalculates the compensation blends based on the most recent gather and the configuration options in the Color/Brightness Uniformity panel.

Compensation type

Depending on the hardware configuration, a different compensation process is undertaken.

Projector class	Camera capabilities	Compensation solution type
Crimson Series, HS Series, Inspire Series	Monochrome	Luminance uniformity
	Color	Luminance uniformity
Boxer Series, Christie M RGB Series, D4K40-RGB, Griffyn Series, Mirage 4K40-RGB, Mirage SST	Monochrome	Luminance uniformity
	Color	Color and luminance uniformity

Luminance uniformity

Results	Description
Auto exposure	A series of white level checkerboard patterns appears. This is required for the camera to be guaranteed to correctly see the range of total light emitted by the projector.
Test patterns	A series of 15 decreasing grey-level flat field test patterns appears. The camera captures this and develops a model for each pixel to achieve luminance uniformity.
Calibration results	The projectors should display consistent luminance across the entire screen as seen by the camera. Projectors are luminance-balanced against one another and deviations in screen brightness due to defects or smudges are diminished. The screen appears more consistent overall than before compensation.

Color uniformity

Results	Description
Auto exposure	A series of red, green, and blue checkerboard patterns appear. This is required for the camera to be guaranteed to correctly see the range of red, green, and blue light emitted by the projector.
Test patterns	A series of color flat field test patterns appears. The camera captures this and develops a model for each pixel's color response to achieve color uniformity. The series should consist of white, grey, black, red, green, blue, magenta, yellow, cyan, orange, chartreuse, spring green, azure, violet, and rose.
Calibration results	The projectors should display consistent colors across the entire screen as seen by the camera. Projectors are color-balanced against one another and deviations in screen color due to defects, background colors, or smudges are diminished. The screen appears more consistent overall than before compensation.

Camera assisted projector convergence

Learn how to automatically correct projector convergence.

Automatically adjusting projector convergence

A convergence problem occurs when one or more projected colors (red, green, and blue) appears misaligned when examined with a convergence test pattern. Mystique Essentials or Pro Venue, in combination with a camera, can be used to automatically adjust convergence electronically during a Mystique run.

The following example shows a poorly converged projector on the left with the far right being the ideally converged projector.

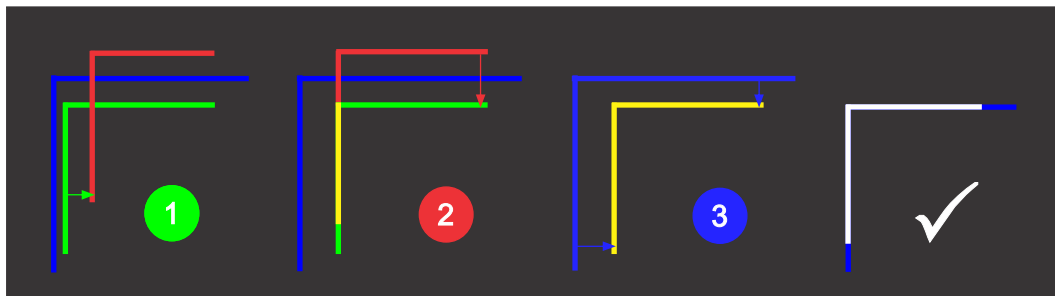

- Only Griffyn Series and Christie M RGB Series projectors support automatic convergence.
- Automatic convergence is not supported with High Contrast mode.

1. Switch to the **Home** tab.
2. In the Electronic Convergence pane, select **Enable**.

When enabled during a Mystique run, all three colors are automatically adjusted to overlap, forming pure white lines throughout the image.

Tuning electronic convergence: advanced convergence options

To achieve the best automatic convergence results, you may need to adjust the scale values of the red, green, and blue channels to correct for aberrations in the camera lens.

1. From the left pane of the Home tab, open **Options > Convergence**.
2. From the list, select the type of lens you are using with your camera.

If the lens is not in the list, you must adjust the scale values manually. Once a lens is selected, the red, green, and blue scale values are set to the defaults for that lens type.

3. To apply the changes to the projector, select **Run Electronic Convergence now with saved data**.
4. If you have not already done a full run with Electronic Convergence enabled, do this before continuing.
5. Using the projector on-screen display controls or the web page, select an appropriate test pattern

For example, select the Convergence or Prism/Convergence test pattern.

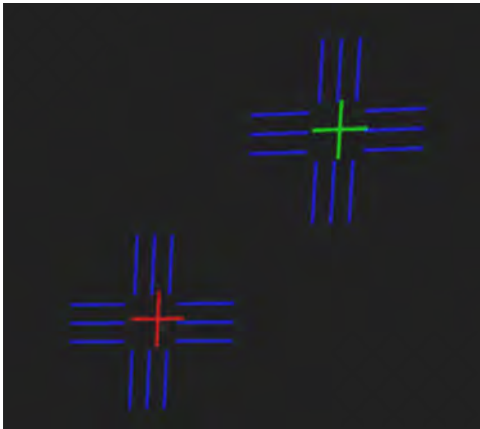

The above image shows the bottom-left corner of a poorly converged projector showing a convergence test pattern. In this example, green is slightly inside blue, and red is significantly inside blue. To correct for this, slightly increase the green scale and increase the red scale slightly more.

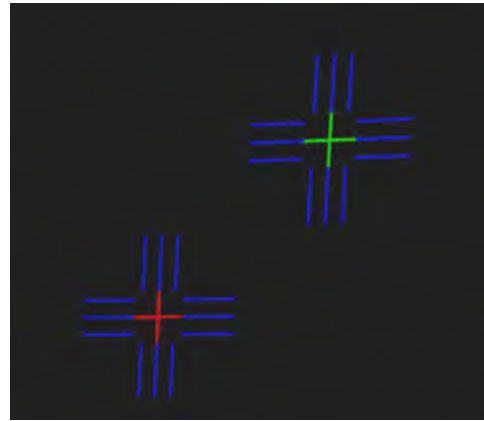

The above example shows the bottom-left corner of a perfectly converged projector. The green and red line up with the blue target.

6. Look at the corners of the screen.

The right image above shows approximately what you should see in each corner. The red and green crosshairs should fall exactly in the center of the blue targets.
7. If the red and green crosshairs do not fall exactly in the center of the blue targets, adjust the scale for the colors not aligned by doing the following:
 - a) Select **Adjust Color Scaling**.
 - b) Adjust the scale values to line colors up to each other.

Increasing a scale value causes the targets to move away from the center of the screen and decreasing the scale value shrinks it towards the center of the screen. For example, if you look at the bottom-left corner and the green crosshairs are too far towards the center of the screen, stretch the green by increasing the green scale.
 - c) To apply the scale changes, select **Run Electronic Convergence now with saved data**.
 - d) Look at the screen again and determine if the alignment is better.

If the alignment is worse, you may have adjusted the scale in the wrong direction.
 - e) If the image is not yet converged, repeat steps b to d, continuing to adjust the scale values and check the corners of the screen until the convergence looks accurate.
 - f) When satisfied with the convergence results, save the Mystique project.

Troubleshooting

Learn about common issues and their solutions.

Viewing and exporting diagnostics

Each time Mystique is run, a new folder for diagnostics files (such as log files or images) is created.

When helping troubleshoot issues with Mystique, Christie Technical Support may ask you to open and read diagnostic files, or to send those files to Christie for further analysis.

Viewing diagnostic files

Learn how to view diagnostic files.

1. Select **Help > Diagnostics > View**.
2. Select one of the following:
 - Crash
 - Data
 - Images
 - Logs

Exporting diagnostic files

Learn how to export diagnostic files.

1. Switch to the **Help** tab.
2. Select **Export**.
3. Select a Mystique session and select **Export Diagnostics**.
4. Browse to where the .zip archive file is to be saved and select **Save**.
5. Find the file on your computer.

The file name begins with **Diags_** and, if you saved your calibration, it includes the calibration file name and the session folder name. This file includes the date and time when you launched Mystique.
6. Send the .zip archive file to Christie Technical Support.

I cannot load Mystique on my computer

In some cases, computers running the Windows 8 operating systems cannot install the Bonjour Service.

Resolution

If your computer is running Windows 8, install the following update, then try loading Mystique again.

- Install the update located here: <https://www.microsoft.com/en-us/download/details.aspx?id=49082>.

If your computer is running Windows 8.1, verify all recommended Windows updates are installed, then complete the following steps.

1. Install the update located here: <https://support.microsoft.com/en-us/help/2919355/windows-rt-8.1,-windows-8.1,-and-windows-server-2012-r2-update-april-2014>.
2. Install the update located here: <https://www.microsoft.com/en-us/download/details.aspx?id=49082>.
3. Load Mystique again.

Mystique cannot locate cameras or projectors

To locate cameras or projectors in a configuration, try any of the following.

Resolution

- Confirm that the computer is connected to a network.
- Check the cable connections (computer, camera, projectors, and so on)
- If using a Teledyne Dalsa camera, install the drivers included with Mystique installation files. They are in the TeledyneDALSA subfolder.
- Make sure that the computer is on the same subnet as the camera or projector.
- Try to access the projector's web interface. From the Select Projectors dialog, in the Manual tab, enter the IP address of the projector.
- On the projector, check the version of the Ethernet firmware.
- On the computer, check that no other Christie software application is running.
- On the computer, verify the Bonjour application is installed and that it is operating as expected.

I cannot find or add a CIC 1DLP camera

To connect a CIC 1DLP camera to a configuration, try the following.

Resolution

- Make sure the camera is connected to one of the supported projectors in your configuration using the supplied USB cable.

For a list of supported projectors, see *Camera recommendations* (on page 13).

- Make sure the projector is powered on.
- Make sure the projector has been added to your configuration.
- From the Camera tab, select **Add Camera**.
CIC 1DLP appears in the search results with the same IP as the connected projector.

I cannot connect to a Point Grey or FLIR camera

To connect a Point Grey or FLIR camera to a configuration, try the following.

Resolution

Make sure the camera is connected to a dedicated router with DHCP enabled. The camera should automatically be assigned an IP address.

If the Point Grey Flea3 camera cannot be detected on the network, try the following:

1. Disable all wireless network connections.
2. Connect one end of an Ethernet cable to the camera.
3. Connect the other end of the Ethernet cable into the network port of the computer running Mystique.
4. Select **Start > Programs > Christie > Mystique > Point Grey Utilities > GigE Configurator**.
5. In the left pane, select your camera.
If the camera is not recognized, for diagnostic information, see the documentation provided by the camera manufacturer.
6. Select **Automatically Force IP**.
7. Set the IP address and subnet for the camera.
 - If the cameras use static IP addresses:
 - Enter the network settings for the camera.
 - Select **LLA & Persistent IP**.
 - Select **Set IP Address /Subnet**.
 - If the cameras use dynamic IP addresses:
 - Select **LLA & Persistent IP**.
 - Select **DHCP**.
 - Select **Set IP Address/Subnet**.
8. Select **Test Camera Connection**.
9. Reconnect the camera to the network.
10. Select **Test Camera Connection**.

I cannot connect to a Teledyne Dalsa camera

To connect a Teledyne Dalsa camera to a configuration, try the following.

Resolution

Make sure the Teledyne Dalsa camera drivers are installed by running the driver installer, which by default is located at C:\Program Files\Christie Digital Systems\Mystique 2.9\TeledyneDALSA\Sepera_It_850_camexpertsetup.exe.

To configure the IP address of the Teledyne Dalsa camera do the following:

1. Open Teledyne's Network Configuration Tool.
2. Select **Scan Network**.
 - If the camera is red, go to step 3.
 - If the camera appears blue, go to step 4.
 - If the camera is not listed make sure it is plugged in, has power, and the computer IP address is properly configured.
3. If the camera is red, complete the following steps:
 - a. Select the red camera.
 - b. Switch to the **Device IP Configuration** tab.
 - c. Select **Automatic Recovery (Force IP)** and wait for it to finish.
 - d. Select **Scan Network**.
If camera is blue, proceed to steps 4.
4. If the camera is blue, complete the following steps:
 - a. Select the blue camera.
 - b. Switch to the **Device IP Configuration** tab.
 - c. Under Persistent IP mode, enter the required IP and/or subnet.
 - d. Select **Apply** and wait for it to finish.
 - e. Power cycle the camera to confirm the settings are persistent.

Point Grey or FLIR camera performance is slow

The performance of Mystique with FLIR cameras in the configuration seems slow (or slower than before installing the Dalsa drivers).

Details

Occasionally, the Status Viewer shows warnings indicating the camera could not retrieve an image.

Resolution

If Dalsa cameras are not used in the configuration, disable the Teledyne DALSA Sopera GigE Vision Filter Driver.

- On your computer, open **Control Panel > Network and Sharing Center**.

- In the left pane, select **Change Adapter Settings**.
- Right-click the **Ethernet** or **Local Area Connection** icon and select **Properties**.
- Find Teledyne DALSA Sopera GigE Vision Filter Driver, right-click and **Disable**.

Point Grey or FLIR camera stops working after networking change

The Point Grey or FLIR camera has stopped working after a networking change.

Resolution

To restore camera functionality, *trigger a camera search* (on page 32) or restart Mystique.

Mystique cannot communicate with a connected device

If Mystique cannot connect to a camera or a Pandoras Box device, try the following.

Resolution

Disable the Windows Firewall on the computer while Mystique interfaces with the connected device.

1. On the computer, navigate to **Start > Control Panel > System and Security > Windows Firewall**.
2. In the left pane, select **Turn Windows Firewall on or off**.
3. Turn off Windows Firewall.
4. Select **OK**.

An intermittent camera connection issue is occurring

If the live camera preview is intermittently replaced by a checkerboard pattern, and the Mystique calibration is also failing, you might be experiencing an intermittent camera connection issue.

Resolving an intermittent camera connection issue if network (GigE) cameras are installed

If you experience an intermittent camera connection issue and network (GigE) cameras are installed, complete the following.

Before you begin, complete the *I cannot connect to a Point Grey or FLIR camera* (on page 100) procedure.

Resolution

Make sure that the Point Grey filter driver is installed.

1. On your computer, open **Control Panel > Network and Sharing Center**.
2. In the left pane, select **Change Adapter Settings**.
3. Right-click the **Ethernet** or **Local Area Connection** icon and select **Properties**.
If installed, the filter driver appears as **Point Grey Lightweight Filter Driver** and, if enabled, the checkbox next to the driver is selected.

If the the filter driver is not installed, from the Properties window, complete the following:

1. Select **Install**.
2. In the Select Network Feature Type window, select **Service > Add**.
3. In the Select Network Service window, select **Have Disk**.
4. In the Install From Disk window, select **Browse**.
5. Navigate to `C:\Program Files\Christie Digital Systems\Mystique 2.9\PointGrey`.
6. Select **pgrlwf.inf**, then select **Open**.
7. In the Install From Disk window, select **OK**.
The Select Network Service window is updated to indicate you selected the Point Grey Lightweight Filter Driver network service.
8. Select **OK**.
The Properties window is updated to indicate that the Point Grey Lightweight Filter Driver is installed.
9. Select **Done**.

If you cannot install the filter driver, complete the following:

1. Select **Start**.
2. In the Search Programs and Files field, enter `regedit` and select **Enter**.
3. Browse to `HKEY_LOCAL_MACHINE\SYSTEM\CurrentControlSet\Network`.
4. In the right pane, double-click **MaxNumFilters**.
5. In the Value Data field, enter `14`.
6. Select **OK**.

Related information

I cannot connect to a Point Grey or FLIR camera (on page 100)

Mystique unexpectedly terminated after connecting to a network (GigE Point Grey) camera

If Mystique unexpectedly terminates when a network (GigE Point Grey) camera is installed and the control computer is running Windows 8.1, Christie recommends the following.

Resolution

1. Install the update located here: <https://support.microsoft.com/en-us/help/2919355>.
2. Restart Mystique.

Resolving an intermittent camera connection issue if USB cameras are installed

Christie recommends restarting the computer after each troubleshooting attempt.

Resolution

- Verify the USB camera is not in use by the Point Grey Fly Capture application or another instance of Mystique.
- Move the USB cable side to side and up and down. If this causes dropped frames, verify the USB cable is correctly attached or replace it altogether.
- On the control computer, connect the USB cable to a different USB port.
- Replace the USB cable.
- Install a shorter USB cable.
- Install a USB hub between the control computer and the camera.

A camera has drifted out of position

If a camera drifts over time, and Mystique cannot recalibrate based on the existing reference image, you receive a dialog message indicating the camera must be repositioned.

Resolution

If you cannot physically access the camera, or cannot reposition it, try one of the following options.

- Disable automatic camera calibration. If you have a marked surface image, manually move the calibration points to fit the live camera image, and then run a manual calibration. This does not create a new reference image.
- Set new calibration points and then create a new reference image. This discards all settings associated with the previous reference image.

The projector is unresponsive

If the projector is unresponsive, try any of the following.

Resolution

- Check that the power source is turned on.
- Verify all cables are connected.
- Check that the control computer can search for projectors.

The calibration file is invalid

To verify a .cal file is valid, check the following.

Resolution

- The selected camera is connected to the network.
- The screen is defined.
- All projectors in the configuration are connected to the network.

High dx, dy values occur during camera calibration

If you experience high dx, dy values during camera calibration, do not attempt to lower the calibration error by moving calibration points away from the marker in the camera image.

Resolution

If the dx, dy values are greater than 1.0, try the following:

- In the image preview, adjust the 2D calibration points so they match the markers or screen corners.

If the tolerance remains greater than 1.0, try the following:

- Verify the screen dimensions are correct.
- Verify the 3D calibration points are correctly defined.

The alignment results are poor

If the alignment results are poor, try any of the following.

Resolution

- Verify the following:
 - There is adequate camera coverage on the screen.
 - The camera is successfully calibrated.
 - Review the exposure and binarization settings. If you selected automatic exposure and binarization, select manual and adjust the values.
 - All cameras are in focus.
 - The camera images aren't over exposed. Select the **Projector Control** tab and select **Show in Markers**. If necessary, adjust the camera aperture.
- In the left pane, expand **Camera**. Expand **Exposure & Binarization**, and then select **Automatic**.
- Ambient light or sunlight on the projected surface can result in the camera having trouble seeing the visible light pattern. Consider dimming the lights to see if results improved.

The camera performance is slow

For optimal results, you should have a minimum of a 1.0 Gigabits per second (Gbps) network connection.

Resolution

Mystique reports the network health of each Ethernet camera in a configuration. To identify which cameras are experiencing issues, or factors that might be contributing to poor camera performance, you can view the summary in the Mystique status bar, or view information specific to each camera under **Camera > Details > Network Health**.

To confirm the speed of the network connection:

1. Select **Start > Control Panel > Network and Sharing Center**.
2. To view the network settings, select a network connection.

The camera and reference image do not align

If the camera and reference images do not align, try any of the following.

Resolution

- Verify the camera image is not inverted.
- Turn off any test patterns in the Projector Control tab to verify Christie Mystique sees the true image and not the projected image.

Mystique test patterns appear as expected but alignment is poor

Test patterns generated by Christie Mystique appear as expected but alignment on the playing surface is poor.

Details

This can occur if the layout in the media server does not match the layout specified in Mystique. For example, if a 300 pixel overlap is specified in Mystique but the content is rendered with 295 pixels, a misalignment of at least five pixels occurs.

Resolution

- Confirm your layout, and update the layout information in either the media server or in Mystique.

I am receiving an error message

The following topics are common error messages might be received when installing or configuring Mystique.

Mystique failed to determine a channel ordering

Channel ordering is only required with the Wallpaper (Simple) layout.

Resolution

- Verify the layout settings are correct. The channel layout must match the projector output.
- Verify every projector is calibrated by the camera.
- Try High Contrast or Manual mode. In the left pane, select **Camera**. Expand the Exposure & Binarization area. In the list, select **High Contrast** or **Manual**.
- Try using the Wallpaper (Advanced) layout. The Wallpaper (Advanced) layout is not available with the Essentials edition of Mystique.

The mapper generated no data

If you receive an error indicating that the mapper generated no data, try any of the following.

Resolution

- Verify each projector is calibrated by at least one camera.
- Remove the lens cap from all cameras.
- If in a dark room, a low aperture setting can result in a black image. To increase or decrease light levels, adjust the camera aperture.
- Verify the camera is pointing at an illuminated surface.
- Try to view the camera image using the software provided by the camera vendor. For example, use FlyCapture with Point Grey cameras. The FlyCapture application is included with Mystique.
 - If you see a clear image with the camera software but not with Mystique, verify the camera and firmware are supported, and contact Christie Technical Support.
 - If the image is visible but unclear, manually focus the camera.

Warps have failed validation

If warps fail validation, try any of the following.

Resolution

- Open the .twistx file to determine which part of the system is problematic. To open a .twistx file, at the top of the screen, select **Home** > **Twist**.
 - Warps that are reasonably accurate are likely associated with projectors that are calibrated correctly.

- Warps that are reasonably linear but are off on the digital micromirror device can indicate an incorrect or swapped channel.
- Warps that are missing or distorted can indicate that the camera cannot see the corresponding projector as expected.
- Verify the layout settings are correct and that the orientation setting matches the projector orientation settings.
- Adjust the projector orientation and mirroring so the on-screen display appears correctly when viewed from the planned end-user position.

A .Net framework initialization error occurred

If a .Net framework initialization error occurs when running the Point Grey Driver Control Utility, complete the following.

Resolution

1. Navigate to `C:\Program Files\Christie Digital Systems\Mystique 2.9\PointGrey`.
2. Run the **dotNetFx40_Clientx86_x64.exe** file.

Projector undershooting is causing distorted blends

Projector undershooting can occur if a projector undershoots the screen or content boundary. This creates a region upon which only one projector can project an image.

Resolution

To correct this issue, in either the Wallpaper (Simple) or the Wallpaper (Advanced) layout, try one of the following:

- To ignore projector undershoot around the border when performing blend calculations and improve blend quality, in the left pane, expand **Options > Twist**. Select the **Smart Undershoot Handling** checkbox.
- If you have an irregular projector or content arrangement, in the left pane, expand **Options > Twist**. Clear the **Smart Undershoot Handling** checkbox. The other projector fills the undershoot area and modifies the blend so it transitions smoothly in to the undershoot region.

Points in alignment patterns are missing

The maximum number of points that a projector can draw is limited by the projector hardware. Some alignment patterns can appear to be missing points, especially if the channel extents are large. This is expected.

For example, a field of view alignment pattern displays a small colored box at every degree confluence point. Degree confluence points are points in the channel where the horizontal and vertical degree measurements are exact integers and occur where horizontal and vertical grid lines cross when placed one-degree apart. Larger channel extents require a greater number of points be drawn. This number could exceed the number that the projector is capable of displaying.

If the number of degree confluence points exceeds the maximum number of points that the projector can display, some points are removed from the pattern. The most relevant points, such as those on 90-degree grid lines, 5-degree major grid lines, or points that are closest to those grid lines are displayed. Less relevant points that fall on minor grid lines might be removed from the test pattern. Similar restrictions apply to projector centric test patterns. Points might be removed from the pattern if the projector has too many points to display or if the points are too close together.

An obstruction is appearing in the path of the projector image

If an obstruction appears between a projector and the projection surface, create a mask to hide the obstruction. Where possible, when creating a mask, Mystique blends the content around the obstruction.

Resolution

To create a mask:

1. Switch to the **Home** tab.
2. To open Twist, select **Twist**.
3. Switch to the **Mask** layer tab.
4. On the canvas, select the projector window for the projector that is obstructed.
5. To adjust the shape of the mask, move one or more points toward the center of the projector window.
6. To add a point, right-click on a grid line then select **Add Point**.
7. To send the mask to a projector, on the canvas, right-click a projector window then select **Send Mask**.
The updated setting is saved to the projector memory.
8. On the projection surface, verify the mask removes all projected light from the obstruction. If it does not, repeat steps 5-7.
9. Repeat steps 4-8 for any additional projector impacted by an obstruction.
10. To save the mask as a configuration file, select **File > Save**.

If the blend zone between two or more projectors is blocked by an obstruction, you can copy the Mask layers to the Blend Mask layers for all impacted projectors.

1. Switch to the **Mask** layer tab.
2. Right-click a projector window then select **Copy Mask**.
3. In the left pane, expand the **Blend Mask** layer tab.
4. Select **Blend Mask**.
5. Right-click a projector window then select **Paste Mask to Blend Mask**.
The Blend layers for each projector are updated when Blend Masks are changed.
6. To send the updated blend to a projector, in the left pane, select **Send**.

To avoid overwriting the mask the next time you run Mystique, do the following:

1. In the left pane, expand **Options**.

2. In the Masking list, select **Use Blend Mask and Mask from Twist file**.
3. To prevent Mystique from calibrating against masked out obstructions in a configuration, select **Use Masked Mappers**.

Technical support

Technical support for Christie Cinema products is available at:

- *Support.cinema@christiedigital.com*
- +1-877-334-4267
- Christie Professional Services: +1-800-550-3061 or *NOC@christiedigital.com*

Technical support for Christie Enterprise products is available at:

- North and South America: +1-800-221-8025 or *Support.Americas@christiedigital.com*
- Europe, Middle East, and Africa: +44 (0) 1189 778111 or *Support.EMEA@christiedigital.com*
- Asia Pacific (*support.apac@christiedigital.com*)
 - Australia: +61 (0)7 3624 4888 or *tech-Australia@christiedigital.com*
 - China: +86 10 6561 0240 or *tech-supportChina@christiedigital.com*
 - India: +91 (80) 6708 9999 or *tech-India@christiedigital.com*
 - Japan: 81-3-3599-7481
 - Singapore: +65 6877-8737 or *tech-Singapore@christiedigital.com*
 - South Korea: +82 2 702 1601 or *tech-Korea@christiedigital.com*
- Christie Professional Services: +1-800-550-3061 or *NOC@christiedigital.com*