The top half of the page features a complex, abstract background of overlapping, semi-transparent blue triangles and polygons in various shades of blue, creating a dynamic, crystalline effect. This pattern transitions into a clean white background at the bottom.

Installation and Setup Guide
020-103078-04

CP2309-RGB

CHRISTIE®

NOTICES

COPYRIGHT AND TRADEMARKS

Copyright © 2023 Christie Digital Systems USA Inc. All rights reserved.

All brand names and product names are trademarks, registered trademarks or trade names of their respective holders.

GENERAL

Every effort has been made to ensure accuracy, however in some cases changes in the products or availability could occur which may not be reflected in this document. Christie reserves the right to make changes to specifications at any time without notice. Performance specifications are typical, but may vary depending on conditions beyond Christie's control such as maintenance of the product in proper working conditions. Performance specifications are based on information available at the time of printing. Christie makes no warranty of any kind with regard to this material, including, but not limited to, implied warranties of fitness for a particular purpose. Christie will not be liable for errors contained herein or for incidental or consequential damages in connection with the performance or use of this material. Our centers of excellence for manufacturing in Kitchener, Ontario, Canada and in Shenzhen, China are ISO 9001:2015 Quality Management System-certified.

Christie is committed to making our documents free from language bias; however, we are not responsible for the language used on any linked or third-party documentation.

For the most current technical documentation and office contact information, visit <https://www.christiedigital.com/>.

Warranty

Products are warranted under Christie's standard limited warranty, the details of which are available at <https://www.christiedigital.com/help-center/warranties/> or by contacting your Christie dealer or Christie.

PREVENTATIVE MAINTENANCE

Preventative maintenance is an important part of the continued and proper operation of your product. Failure to perform maintenance as required, and in accordance with the maintenance schedule specified by Christie, voids the warranty. For preventative maintenance schedules, refer to www.christiedigital.com.

REGULATORY

The product has been tested and found to comply with the limits for a Class A digital device, pursuant to Part 15 of the FCC Rules. These limits are designed to provide reasonable protection against harmful interference when the product is operated in a commercial environment. The product generates, uses, and can radiate radio frequency energy and, if not installed and used in accordance with the instruction manual, may cause harmful interference to radio communications. Operation of the product in a residential area is likely to cause harmful interference in which case the user will be required to correct the interference at the user's own expense. Changes or modifications not expressly approved by the party responsible for compliance could void the user's authority to operate the equipment

CAN ICES-3 (A) / NMB-3 (A)

이 기기는 업무용(A급)으로 전자파적합등록을 한 기기이오니 판매자 또는 사용자는 이점을 주의하시기 바라며, 가정 외의 지역에서 사용하는 것을 목적으로 합니다.

ENVIRONMENTAL



The product is designed and manufactured with high-quality materials and components that can be recycled and reused. This symbol  means electrical and electronic equipment, at their end-of-life, should be disposed of separately from regular waste. Please dispose of the product appropriately and according to local regulations. In the European Union, separate collection systems are for used electrical and electronic products.

If printing this document, consider printing only the pages you need and select the double-sided option.

Please help us to conserve the environment we live in!

Notation

Learn the hazard and information symbols used in the product documentation.



Danger messages indicate a hazardous situation which, if not avoided, results in death or serious injury.



Warning messages indicate a hazardous situation which, if not avoided, could result in death or serious injury.



Caution messages indicate a hazardous situation which, if not avoided, could result in minor or moderate injury.



Notice messages indicate a hazardous situation which, if not avoided, may result in equipment or property damage.



Information messages provide additional information, emphasize or provide a useful tip.

Content

Introduction	5
Product documentation.	5
Related documentation.	5
Safety precautions.	6
General safety precautions.	6
Laser safety precautions.	6
AC power precautions.	7
Product labels.	7
Light intensity hazard distance.	10
List of components.	12
Key features.	12
CineMaster cinema calculator tool.	12
Contact your dealer.	12
Technical support.	13
Installing and setting up	14
Site requirements.	14
Projector components (front).	15
Projector components (rear).	16
Preparing the installation site.	16
Lifting and positioning the projector.	16
Connecting to power.	17
Connecting to an uninterruptable power supply.	20
Installing the lens.	21
Projection lens.	22
Installing the touch panel.	23
Projector power modes.	24
Turning on or off the projector.	25
Logging into the projector.	25
Turning on or off the light source.	25
Activating marriage.	25
Disposing of the product packaging.	26
Completing the installation checklist.	26

Connecting devices and establishing communication. 27

- Projector head connections and status LEDs. 27
 - Projector LED status indicators. 28
 - SM and FIPS LED status indicators. 28
 - LED status indicators. 29
- Connecting the projector to a network. 29
- Connecting the devices to the 3D port. 29

Managing the light source. 30

- Creating a new laser file. 30
- Modifying an existing laser file. 31
- Copying existing laser settings to a new file. 32
- Deleting a laser file. 32

Adjusting the image. 34

- Calibrating the Intelligent Lens System. 34
- Correcting vignetting. 34
- Adjusting tilt and leveling the projector. 34
- Correcting keystone effect. 35
- Displaying a test pattern. 36
- Adjusting the integrator rod and fold mirror. 36
- Adjusting vertical boresight. 39
- Adjusting horizontal boresight. 40
- Adjusting digital micromirror device (DMD) convergence. 41
- Correcting on-screen color. 42

Regulatory. 43

- Safety. 43
- Electro-magnetic compatibility. 43
 - Emissions. 43
 - Immunity. 43
- Environmental. 43

Introduction

This manual is intended for professionally trained operators of Christie high-brightness CP2309-RGB projection systems.

For complete product documentation and technical support, go to www.christiedigital.com.

Product documentation

For installation, setup, and user information, see the product documentation available on the Christie website. Read all instructions before using or servicing this product.

1. Access the documentation from the Christie website:
 - Go to <http://bit.ly/2V2E9wp> or <https://www.christiedigital.com/en-us/cinema/cinema-products/digital-cinema-projectors/christie-cp2309-rgb>
 - Scan the QR code using a QR code reader app on a smartphone or tablet.



2. On the product page, select the model and switch to the **Downloads** tab.

Related documentation

Additional information on the projector is available in the following documents.

- *CP2309-RGB User Guide (P/N: 020-103081-XX)*
- *CP2309-RGB Product Safety Guide (P/N: 020-103079-XX)*
- *Cinema 2K-RGB Service Guide (P/N: 020-102770-XX)*
- *CineLife Serial Commands Guide (P/N: 020-102774-XX)*
- *CP2309-RGB Specifications Guide (P/N: 020-103082-XX)*

Safety precautions

Learn about the safety precautions related to the Christie CP2309-RGB projector. This projector is intended for use in a cinema environment.

General safety precautions

Read all safety and warning guidelines before installing or operating the projector.



Warning! If not avoided, the following could result in death or serious injury.

- TRIP OR FIRE HAZARD! Position all cables where they cannot contact hot surfaces, be pulled, be tripped over, or damaged by persons walking on or objects rolling over the cables.
- This product must be installed within a restricted access location not accessible by the general public.
- Only personnel who are trained on the precautions for the restricted access location can be granted entry to the area.
- Install the product so users and the audience cannot enter the restricted area at eye level.
- ELECTRICAL and BURN HAZARD! Use caution when accessing internal components.
- High leakage current present when connected to IT power systems.
- FIRE AND SHOCK HAZARD! Use only the attachments, accessories, tools, and replacement parts specified by Christie.
- FIRE HAZARD! Do not use a power cord, harness, or cable that appears damaged.
- HAZARDOUS SUBSTANCE! Use caution when handling the product as it contains ethylene glycol. Do not ingest coolant. For information on safe handling, refer to the Safety Data Sheet (SDS) for the coolant.
- A minimum of four people or appropriately rated lift equipment is required to safely lift, install, or move the product.
- Do not install or operate the projector in any position that does not meet the stated product specifications for alignment and orientation.



Caution! If not avoided, the following could result in minor or moderate injury.

- Only Christie qualified technicians are permitted to open product enclosures.

Laser safety precautions

Read all safety and warning guidelines before operating the projector laser.



Warning! If not avoided, the following could result in death or serious injury.

- Do not operate the cinema projector without all of its covers in place.
- LASER RADIATION HAZARD! This projector has a built-in Class 4 laser module. Never attempt to disassemble or modify the laser module.
- Do not look directly into the lens when the light source is on. The extremely high brightness can cause permanent eye damage.
- Possible hazardous optical radiation emitted from this product. (Risk group 3)

AC power precautions

Read all safety and warning guidelines before connecting to AC power.



Warning! If not avoided, the following could result in death or serious injury.

- SHOCK HAZARD! Only use the AC power cord provided with the product or recommended by Christie.
- FIRE AND SHOCK HAZARD! Do not attempt operation unless the power cord, power socket, and power plug meet the appropriate local rating standards.
- SHOCK HAZARD! Do not attempt operation if the AC supply is not within the specified voltage and current, as specified on the license label.
- SHOCK HAZARD! The AC power cord must be inserted into an outlet with grounding.
- SHOCK HAZARD! Disconnect the product from AC before installing, moving, servicing, cleaning, removing components, or opening any enclosure.
- Install the product near an easily accessible AC receptacle.
- Always connect the ground or earth first to reduce shock hazard.
- A certified electrician must be present during installation to make sure the installation meets the local electrical code.



Caution! If not avoided, the following could result in minor or moderate injury.

- Use an appropriately sized strain relief connector with the knockout plate provided, to make sure adequate environmental sealing and to prevent the AC supply cable from accidentally being torn out or rubbing against the knockout plate.
- FIRE HAZARD! Do not use a power cord, harness, or cable that appears damaged.
- FIRE OR SHOCK HAZARD! Do not overload power outlets and extension cords.
- SHOCK HAZARD! Power supply uses double pole/neutral fusing.

Product labels

Learn about the labels that may be used on the product. Labels on your product may be yellow or black and white.

General hazards

Hazard warnings also apply to accessories once they are installed in a Christie product connected to power.

Fire and Shock Hazard	
	<p>To prevent fire or shock hazards, do not expose this product to rain or moisture. Do not alter the power plug, overload the power outlet, or use it with extension cords. Do not remove the product enclosure. Only Christie qualified technicians are authorized to service the product.</p>
Electrical Hazard	
	<p>Risk of electric shock. Do not remove the product enclosure. Only Christie qualified technicians are authorized to service the product.</p>



General hazard.



Electrocution hazard. To avoid personal injury, always disconnect all power sources before performing maintenance or service procedures.



Hot surface hazard. To avoid personal injury, allow the product to cool for the recommended cool down time before performing maintenance or service.



Burn hazard. To avoid personal injury, allow the product to cool for the recommended cool down time before performing maintenance or service.



Optical radiation hazard. To avoid personal injury, never look directly at the light source.



Moving parts hazard. To avoid personal injury, keep hands clear and loose clothing tied back.



Fan hazard. To avoid personal injury, keep hands clear and loose clothing tied back. Always disconnect all power sources before performing maintenance or service procedures.



Laser hazard. To avoid personal injury, avoid eye or skin exposure to direct or scattered radiations.



Voltage hazard. To avoid personal injury, always disconnect all power sources before performing maintenance or service procedures.



Not for household use.

Mandatory action



Consult the user manual.



Consult the service manual.



Disconnect all power sources before performing maintenance or service procedures.

Electrical labels



Indicates the presence of a protective earth ground.



Indicates the presence of an earth ground.

Additional hazards



Indicates high leakage current. Earth or ground connection essential before connecting the power supply.



Indicates a light hazard. Do not look directly into the lens. The extreme high brightness can cause permanent eye damage. RG2 IEC 62471-5:2015

Laser hazards

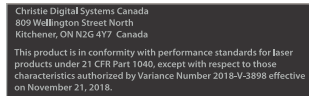

FDA laser variance (US projectors only)



CLASS 1 LASER PRODUCT IEC 60825-1:2014
Wavelengths: 450 nm - 661 nm

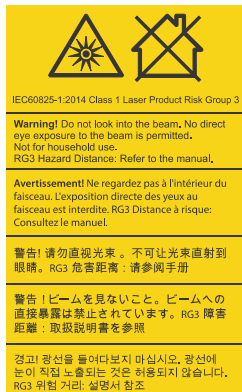

Indicates a light hazard. Do not look directly into the lens. The extreme high brightness can cause permanent eye damage.

Class 1 Laser Product - Risk Group 3 according to IEC 60825-1:2014 and IEC 62471-5:2015



Indicates Class 4 laser radiation when open. Avoid eye or skin exposure to direct or scattered radiation.

Light intensity hazard distance

This projector has been classified as Risk Group 3 as per the IEC 62471-5:2015 standard due to possible hazardous optical and thermal radiation being emitted.



Warning! If not avoided, the following could result in serious injury.

- PERMANENT/TEMPORARY BLINDNESS HAZARD! No direct exposure to the beam must be permitted. Class 1 Laser Product - Risk Group 3 according to IEC 60825-1:2014 and IEC 62471-5:2015.
- PERMANENT/TEMPORARY BLINDNESS HAZARD! Operators must control access to the beam within the hazard distance or install the product at the height that prevents exposure of spectators' eyes within the hazard distance. The hazard zone must be no lower than 2.5 meters/8.2 feet (US installations) or 2.0 meters/6.6 feet (global installations) above any surface upon which any persons are permitted to stand and the horizontal clearance to the hazard zone must be a minimum 1.0 meters.
- EXTREME BRIGHTNESS! Do not place reflective objects in the product light path.

The following show the zones for ocular and skin hazard distances.

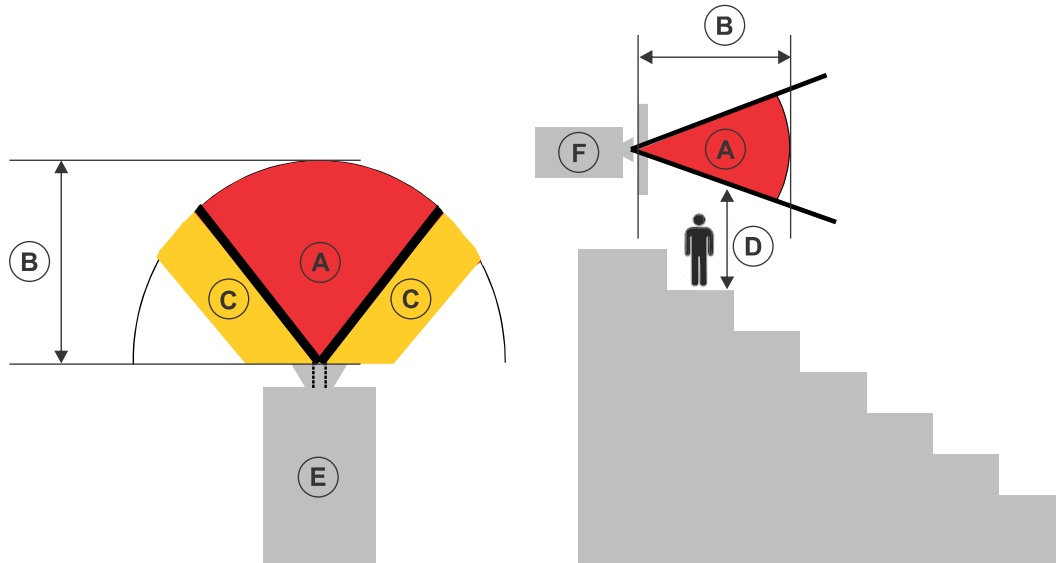

- A—Hazard zone. The region of space where the projection light from the laser-illuminated projector is above emission limits for Risk Group 2. The light intensity may cause eye damage after a momentary or brief exposure (before a person can avert their eyes away from the light source). The light may cause skin burns to occur.
- B—Hazard distance. Operators must control access to the beam within the hazard distance or install the product preventing potential exposure of the spectators' eyes from being in the hazard distance.
- C—No access zone. Horizontal clearance of the no access zone must be a minimum of 1.0 meters (3.3 feet).
- D—Vertical distance to hazard zone. The hazard zone must be no lower than 2.5 meters/8.2 feet (US installations) or 2.0 meters/6.6 feet (global installations) above any surface upon which any persons are permitted to stand.

If the vertical distance to hazard zone requirement (Zone D) is satisfied, the horizontal clearance distance (Zone C) is not needed.

- E—Represents the top view of the projector.
- F—Represents the side view of the projector.

The following table lists the hazard distance for the Christie projector lens with the zoom adjusted to its most hazardous position.

For US and international hazard distances based upon IEC 62471-5:2015, *Photobiological Safety of Lamps and Lamp Systems – Part 5: Image Projectors*.

Projection lens	Part number	Hazard distance (m)
1.2-1.72:1 .69" DLPCine zoom lens	108-494108-XX	1.1
1.33-2.1:1 .69" DLPCine zoom lens	108-495109-XX	1.4
1.62-2.7:1 .69" DLPCine zoom lens	108-496100-XX	1.8
2.09-3.9:1 .69" DLPCine zoom lens	108-497101-XX	2.7



The following graph is for reference only and the above hazard distance of the table must be followed.

CP2309-RGB lenses hazard distances

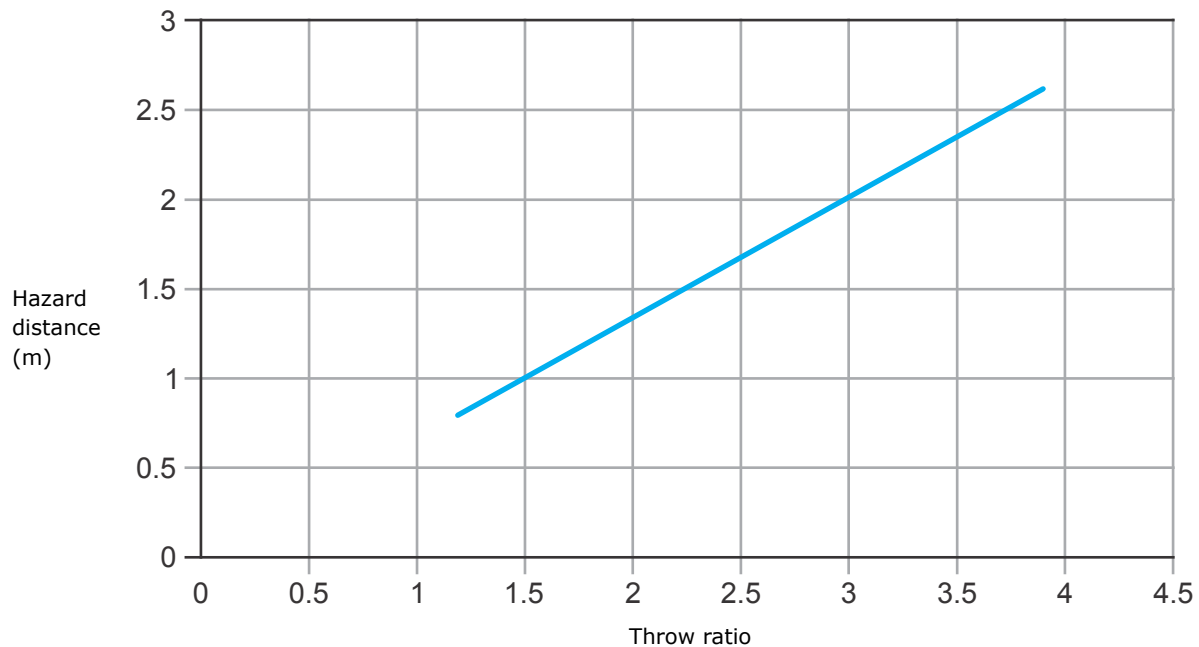

— CP2309-RGB lenses

For Installations in the United States

The following must be in place for laser-illuminated projector installations in the United States:

- The projection room shall be clearly identified by the posting of laser warning and restricted access signs, and by restricting entry through physical means. The projection room sign must display the warning "No direct exposure to beam shall be permitted".

- The Christie Laser Projection System Installation Checklist must be fully completed after the installation and sent to lasercompliance@christiedigital.com. A copy can remain on-site. This checklist can be found as a separate document in the accessory box with the manual.
- Certain US states have additional laser regulatory requirements. Contact lasercompliance@christiedigital.com for additional regulatory requirements.

List of components

Verify all components were received with the projector.

- Touch panel, touch panel harness, and panel mounting arm
- High security key to open the projector service access door
- Hex screwdriver

An optional UPS inlet power cord is also available. For information on available accessories, see *CP2309-RGB Specifications Guide (P/N: 020-103082-XX)*.

Key features

Understand the important features of the projector.

- Solid-state Christie RealLaser™ RGB laser illumination
- Three-chip 0.69 inch SFB DC2K light engine
- Christie CineLife™ Series 3 electronics
- LiteLOC™ color lock feature for constant image brightness and color
- Direct-coupled laser module integrated in the projector chassis
- Compact form to fit in existing projection booths
- Exhaust air extraction (using optional accessory)

CineMaster cinema calculator tool

The CineMaster cinema calculator tool helps you calculate and configure the optimal cinema set up. Use this tool to help determine the right projector, lens, and lamp based on the unique needs of your installation, as well as your preferred projector type, screen configuration, and brightness requirements.

<https://cinemaster.christiedigital.com/>

Contact your dealer

Record the information about your installation and keep this information with your records to assist with any servicing of your product. If you encounter a problem, contact your dealer.

Purchase record

Dealer:

Purchase record

Dealer or Christie Sales/Service contact phone number:

Serial number:

The serial number can be found on the license label.

Purchase date:

Installation date:

Technical support

Technical support for Christie Cinema products is available at:

- *Support.cinema@christiedigital.com*
- +1-877-334-4267
- Christie Professional Services: +1-800-550-3061 or *NOC@christiedigital.com*

Installing and setting up

Learn how to position and install the projector.

Site requirements

To safely install and operate the CP2309-RGB projector, the installation location must meet these minimum requirements.

Physical operating environment

- Ambient temperature (operating) 10 to 35°C (50 to 95°F)
- Humidity (non-condensing) 10% to 80%
- Operating altitude 0 to 3000 meters (0 to 9843 feet)
In China, the operating altitude is 0 to 2000 meters (0 to 6562 feet)

External exhaust ducting

Sufficient ventilation is required around the projector to regulate the temperature of the internal laser module. If necessary, air intake and exhaust HVAC ducts can be installed.

An exhaust duct is also available for purchase as an optional accessory (P/N: 163-112105-XX). Instructions for installing the exhaust duct are included with the accessory part.

The installation site must provide an airflow 450 cubic feet per minute (CFM) at 1 to 1000 meters elevation, and must accommodate a heat load of 4 kW.



For each additional 1000 meters above sea level, increase the airflow (CFM) value by 15%. If an extraction duct is not used, the operating temperature range is restricted to 10 to 25°C (50 to 77°F) at a maximum altitude of 3000 meters.

Permanent power connection

The projector must be connected to power using a hard-wired connection. The projector light source requires the permanent AC connection to operate. There is also an available connector for an uninterruptible power supply (UPS) to provide backup power for the projector electronics only.

Certified wall breakers are required as part of the installation. Breakers must be part of the building and easily accessible. The size of the breaker is determined from the power requirements of the projector and can be up to 30A maximum for the main input and up to 20A maximum for the UPS input.

Projector components (front)

Learn about the components on the front of the projector

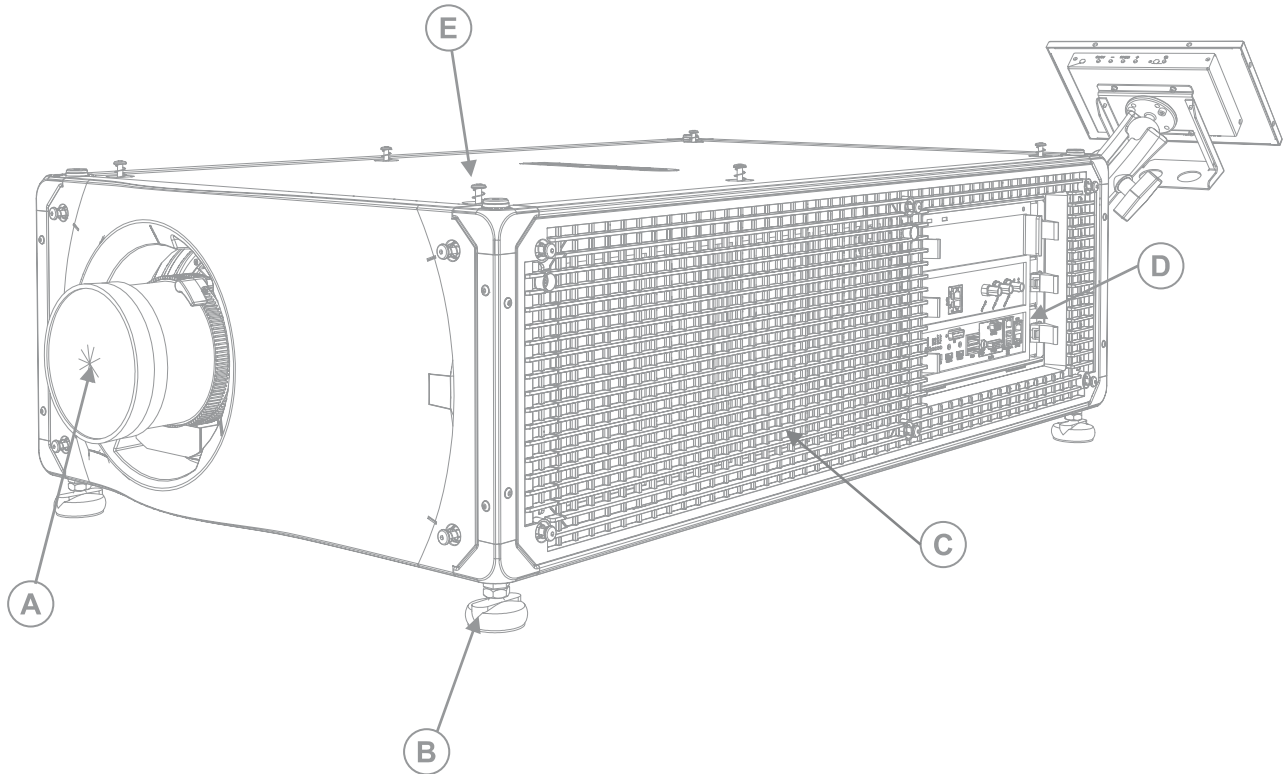

A	<p>Projector lens</p> <p>A list of available lenses is available in the projector specifications. For more information, see the <i>CP2309-RGB Specifications Guide (P/N: 020-103082-XX)</i>, <i>CP2315-RGB Specifications Guide (P/N: 020-102776-XX)</i>, or <i>CP2320-RGB Specifications Guide (P/N: 020-102777-XX)</i>.</p>
B	<p>Adjustable feet</p> <p>Turn the adjustable feet to increase or decrease the projector height.</p>
C	<p>Laser optical subsystem (LOS) air filter intake</p>
D	<p>Card cage</p> <p>External devices are connected here.</p>
E	<p>Top cover</p>

Projector components (rear)

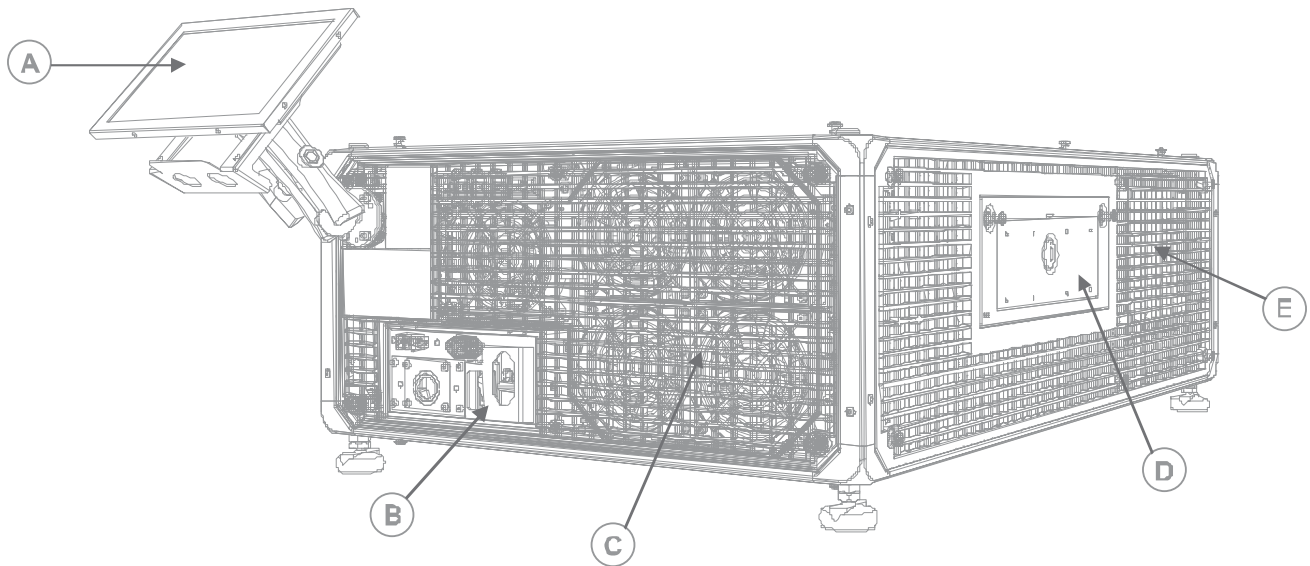

A	Touch panel A touch-sensitive screen used to control the projector.
B	Power cord, AC receptacle, and AC circuit breakers, and fire alarm interlock terminal
C	Air exhaust
D	Tool box and convergence access (CP2315-RGB and CP2320-RGB only)
E	Light engine air filter intake

Preparing the installation site

Make sure the installation area is ready for the components.

1. Clear the installation area.
2. Post laser hazard warning signs at all entry doors.
3. Place each component near its installation location.

Lifting and positioning the projector

Safely lift and position the projector in the location where it will be used.



Warning! If not avoided, the following could result in death or serious injury.

- A minimum of four people or appropriately rated lift equipment is required to safely lift, install, or move the product.
- Do not install or operate the projector in any position that does not meet the stated product specifications for alignment and orientation.

This product must be installed in a landscape orientation, with all four feet supported on a level surface. Do not install or operate the projector in an inverted position. If your site has any installation requirements other than a typical theater projection booth, contact Christie for assistance.



Before lifting and positioning the projector, refer to the light intensity hazard distances.

1. Position each person at the corners of the projector.
2. Place both hands under the corner, grasping the projector frame.
Do not lift the projector using any feature on the projector cover, such as the cover louvers or lens opening.
3. Lift up the projector and move it to the location where it will be used.
4. Position the projector so it is centered and parallel with the theater screen.
If space is limited, aim the projector slightly off-center and use lens offset to center the image on the screen.

Related information

Light intensity hazard distance (on page 10)

Connecting to power

The projector must be connected to power using a hard-wired connection.

The projector light source requires a permanent AC connection to operate. An uninterruptible power supply (UPS) to provide backup power for the projector electronics only is also available. When connecting the projector to AC power, follow all electrical codes for your location.



Warning! If not avoided, the following could result in death or serious injury.

- Always connect the ground or earth first to reduce shock hazard.
- FIRE HAZARD! Do not use a power cord, harness, or cable that appears damaged.
- FIRE AND SHOCK HAZARD! Do not attempt operation unless the power cord, power socket, and power plug meet the appropriate local rating standards.
- SHOCK HAZARD! Do not attempt operation if the AC supply is not within the specified voltage and current, as specified on the license label.
- SHOCK HAZARD! A dedicated, protected ground or earth wire must be installed on the product by Christie qualified technicians or electricians before it can be connected to power.
- A certified electrician must be present during installation to make sure the installation meets the local electrical code.



Caution! If not avoided, the following could result in minor or moderate injury.

- Use an appropriately sized strain relief connector with the knockout plate provided, to make sure adequate environmental sealing and to prevent the AC supply cable from accidentally being torn out or rubbing against the knockout plate.



- A certified wall circuit breaker is required. It must be part of the building and easily accessible.
- Use a minimum of 12 AWG copper wire, grounding included, for the connection of the main AC supply to the projector's ground lug.
- Either copper or aluminum is acceptable as conductor wiring material to the terminal block.

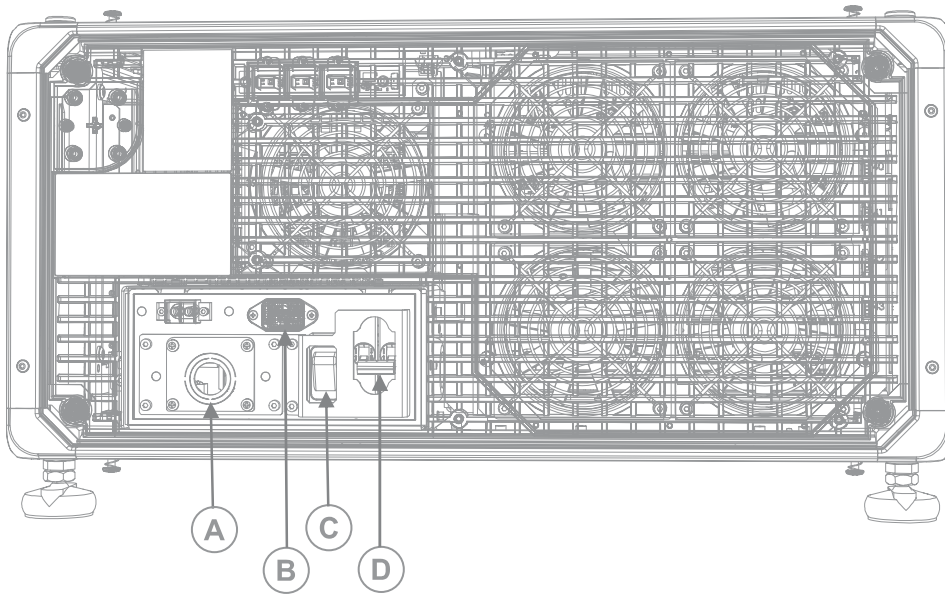

A	200-240 V main inlet
B	UPS inlet
C	UPS circuit breaker (10A)
D	MAIN input circuit breaker (15A)

1. Remove the four screws holding the AC receptacle knockout plate.

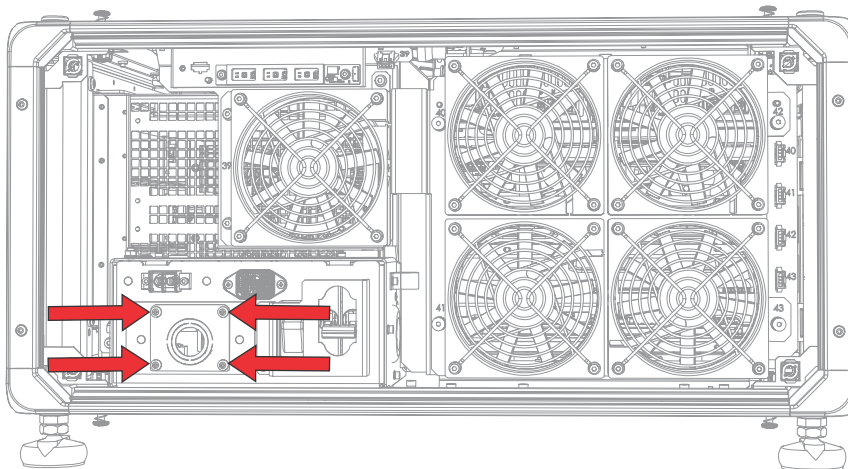

The AC supply is routed to the terminal block through an appropriate strain relief mounted on this knockout plate.

2. To open the AC input area of the projector, remove the four screws holding the cover and swing the cover downwards to open it.

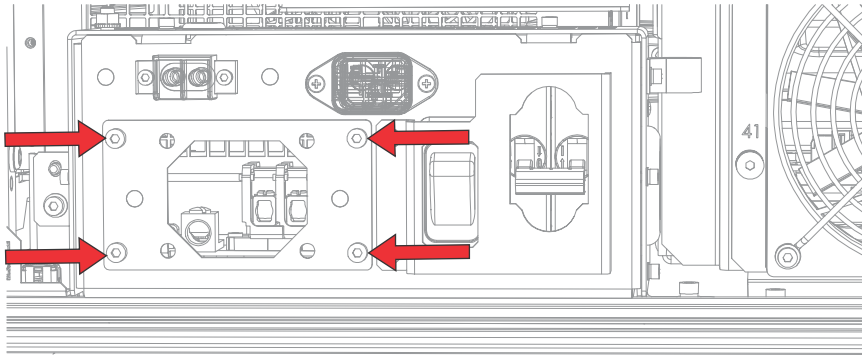

3. Taking the approved line cord for your location, strip the cable jacket to expose a 100 mm length of the bundled wires.
4. Cut the Line (black or brown) and Neutral (white or blue) wires to shorten them to a length between 60 to 70 mm.
5. Using a wire stripper, strip the insulation from each individual wire to expose 10 mm of bare wire on the end.
6. Pass the wires through the strain relief on the knockout plate and through the AC input cover.
7. Fasten the bare end of the wires into the Ground (G), Line (L), and Neutral (N) terminal block connectors, starting first with the Ground (green) connection, followed by the Line (black or brown) and Neutral (white or blue) connections.

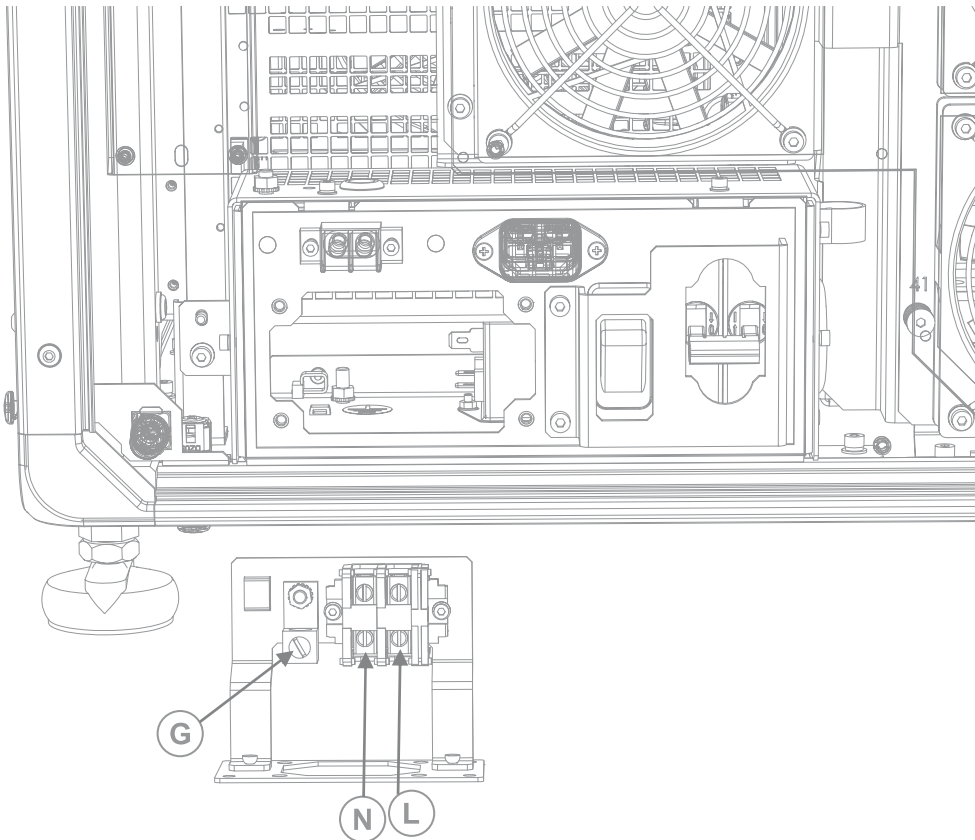

8. Lift the AC input cover into place and re-attach it using the four screws.

- Using the four screws, re-attach the knockout plate and make sure the appropriate strain relief is in place.

Related information

Connecting to an uninterruptable power supply (on page 20)

Connecting to an uninterruptable power supply

An uninterruptible power supply (UPS) allows the cinema projector head electronics to remain operable during a power failure.



Warning! If not avoided, the following could result in death or serious injury.

- SHOCK HAZARD! The AC power cord must be inserted into an outlet with grounding.

The following table lists the part numbers for the optional UPS power cords for each region.

Power cord description	Part number
North America 125V/15A	108-382104-XX
Japan 125V/12A	108-371102-XX
China 250V/10A	108-373104-XX
UK 250V/10A	108-388100-XX
EU/Korea 250V/10A	108-390103-XX
Australia 250V/10A	108-392105-XX
South Africa 250V/10A	108-487100-XX

- Remove the projector touch panel.
- Remove the rear cover of the projector by loosening the six screws.

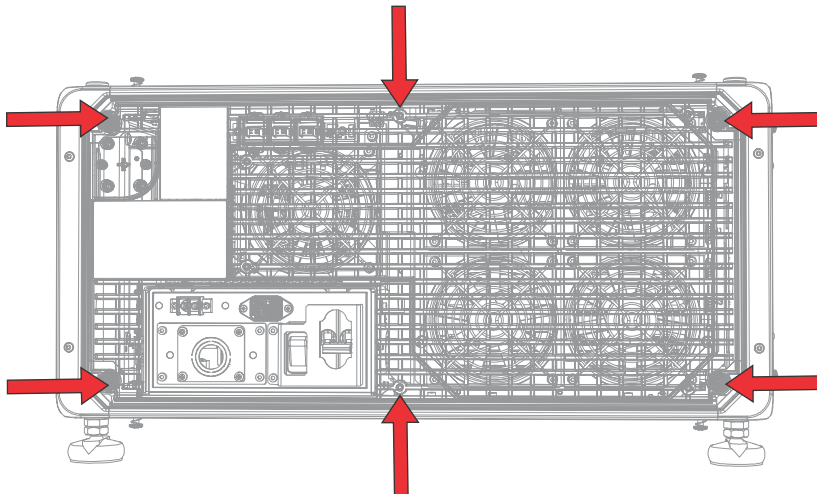

- Between the exhaust fans and the AC box assembly, disconnect the MAIN input plug from the IN-LINE receptacle.
- Remove the protective cap from the UPS input plug.

5. Connect the UPS input plug to the IN-LINE receptacle connector.

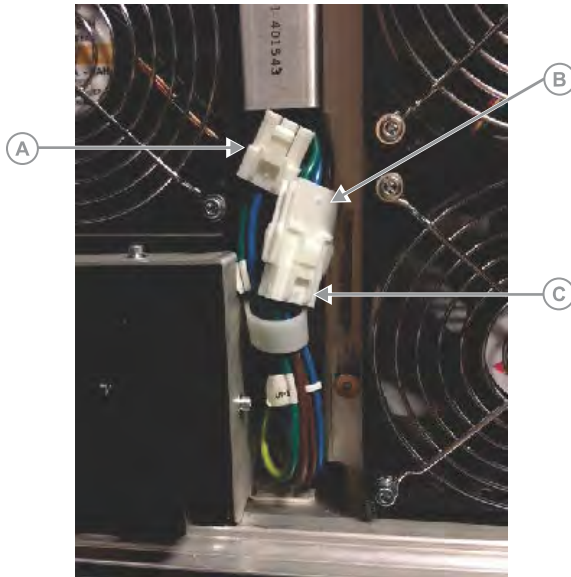

A	MAIN input plug
B	IN-LINE receptacle
C	UPS input plug

6. Place the protective cap from the UPS plug on the MAIN input plug.
7. Re-install the rear cover of the projector.
8. Re-install the projector touch panel.
9. Plug in the appropriate UPS power cord to the UPS and then into the UPS input (Input B) on the projector.

Installing the lens

The lens seals the projection head, preventing contaminants from entering the main electronics area.

Before installing the lens, make sure you turn off and unplug the projector.

Do not operate the projector without a lens installed. Install a lens plug when installing or transport the projector.

1. Remove the lens surround.
2. On the front of the projector, unlock the lens assembly with a hex key.

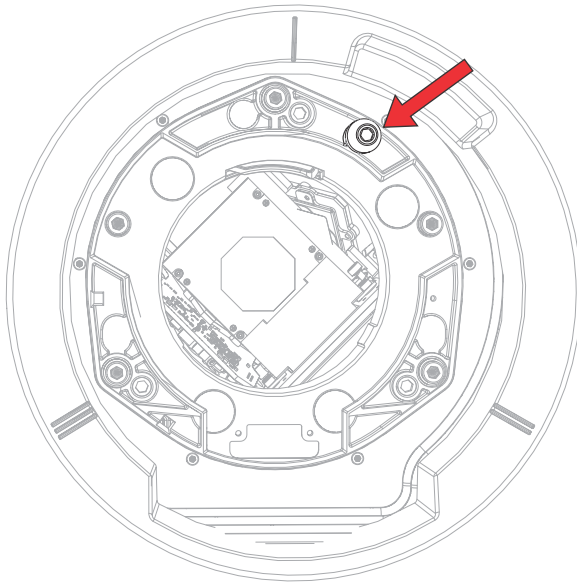

3. Position the lens so the lens retaining ring mounts align with the lens mount.
4. Remove the lens caps from the front and rear of the lens.



Lens caps must be removed or they can melt and damage the lens.

5. Insert the lens straight into the lens mount opening without turning. Magnets inside the lens mount help position the lens.
6. Lock the lens assembly in place with a hex key.
7. Replace the lens surround.

Projection lens

Use the correct method of removing the lens.

1. For motorized lens mounts, disconnect the lens zoom motor from the two zoom motor harness connectors.
2. On the front of the projector, unlock the lens assembly with a hex key.

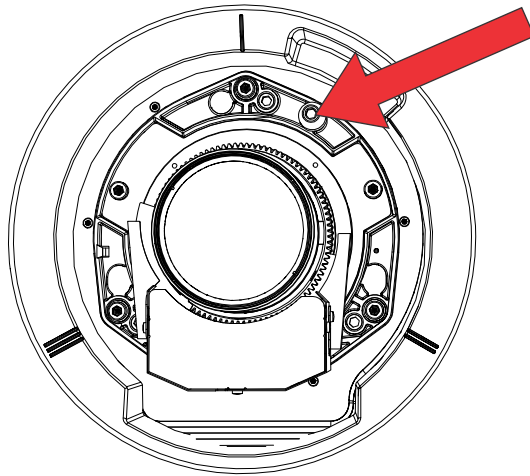

3. Slide the lens straight out of the projector.
If the lens does not slide out easily, reset the lens offset. Lock the lens before performing reset so it does not fall out.
4. Attach the lens cap to avoid damage to the lens.
5. To re-install, follow these steps in reverse order.

Installing the touch panel

The touch panel controls projector functions and provides quick access to projector information.

1. Remove the touch panel and the mounting arm from their packaging.
2. Attach one end of the touch panel mounting arm over the ball joint on the rear of the touch panel.

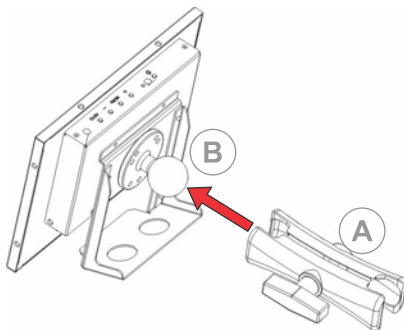

A	Mounting arm
B	Ball joint

3. While supporting the touch panel, fit the other end of the touch panel mounting arm over the ball joint on the rear panel or electronics side of the projector.
4. Tighten the mounting arm until it fits tightly on the ball joint.

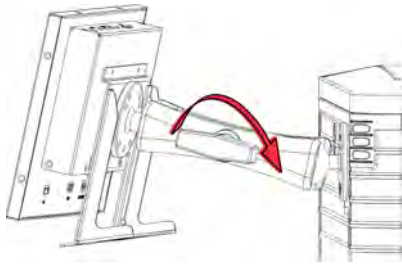

5. Connect the touch panel harness to the touch panel:
 - a) Connect one end of the USB cable to the USB port on the rear of the touch panel.
 - b) Connect one end of the touch panel power cable to the **DC IN 12V** port on the rear of the touch panel.
 - c) Connect one end of the VGA connector to the **VGA** port on the rear of the touch panel.
6. Connect the touch panel harness to the projector:
 - a) Connect the other end of the USB cable to a USB port on the projector communications panel.
 - b) Connect the other end of the touch panel power cable to the Screen Power port on the projector communications panel.
7. To turn on the touch panel, select the **Power** button on the top of the panel.
 If the projector is not connected to AC power with breakers in the ON position, you cannot turn on the touch panel.

Projector power modes

The CP2309-RGB projectors track laser operation hours for the laser optical subsystem (LOS).

The projector operates with the following power modes:

Mode	Description
Projector on	<ul style="list-style-type: none"> • CineLife+ electronics and light engine are on • Laser optical subsystem (LOS) is off • Thermo-electric cooler (TEC) devices for CP4415-RGB and CP4420-RGB are off • Integrated Media Block (IMB) is on
Light source on	<ul style="list-style-type: none"> • CineLife+ electronics and light engine are on • LOS is on • TEC devices for CP4415-RGB and CP4420-RGB are on • Fans run at full speed • IMB is on
Standby	<ul style="list-style-type: none"> • CineLife+ electronics remain on standby with the light engine off • Fans and LOS are off • TEC devices for CP4415-RGB and CP4420-RGB are off • IMB is off—IMB automation does not function

Mode	Description
IMB powered in Standby	<ul style="list-style-type: none"> • Turns on the IMB • Increases the air flow inside the projector to cool the card cage electronics

Turning on or off the projector

Turn on the projector to display content or turn off the projector to conserve energy or service the projector.

1. To operate the projector, make sure the circuit breakers are in the ON position.
If servicing the projector or removing the protective covers, make sure the MAIN and UPS circuit breakers are in the OFF position.
2. In the right toolbar, select and hold **Power**. 

If the light source is on when turning off the projector, the light source automatically enters a ten-minute cool-down period.

Logging into the projector

Log into the projector to access projector menus.

1. Select **Login**.
2. In the User list, select a username.
3. Enter your password.
4. Select **Login**.

Turning on or off the light source

Turn on the light source to display content or view test patterns. Turn off the light to extend the life of the light source.

- To turn on or off the light source, in the right toolbar, select and hold **Light**. 

If turning on the light source when the projector power is off, power is turned on automatically. Allow the projector to cool down for 10 minutes after turning it off.

Activating marriage

After selecting the Integrated Media Block (IMB) type, you must install the IMB and complete marriage to display secure content and to comply with the Digital Cinema Initiatives (DCI) specification. You cannot complete marriage remotely.

For more information on marriage, refer to *CP2309-RGB User Guide (P/N: 020-103081-XX)*.

You cannot complete marriage remotely because you must select the **Marriage** button on the input panel during the marriage process.

1. Verify the marriage ring is installed correctly and an anti-tamper alarm does not appear on the touch panel.
2. In the left navigation menu, select **Service Setup** > **Marriage Setup**.
3. Select **Start** and complete the Marriage Setup wizard.
At the Arming stage, enter the Marriage password.
4. Select **Finish**.

Disposing of the product packaging

Once the product has been installed and set up, Christie recommends reusing or recycling the product packaging according to your local regulations.

Completing the installation checklist

Complete the provided installation checklist (P/N: 020-103137-XX) and return it to Christie.

Connecting devices and establishing communication

To display content, you must connect a device capable of storing or playing content to the projector.

Projector head connections and status LEDs

Understand the inputs on the projector.

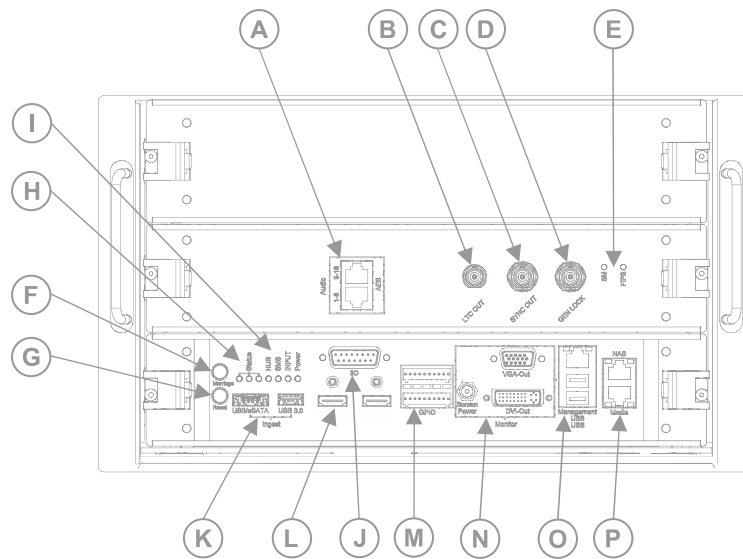

A	AES3 port for digital audio output.
B	Linear Time Code (LTC) output.
C	Output for multi-projector playback.
D	Input for multi-projector playback (Christie Integrated Media Block (IMB) to Christie IMB only).
E	SM and FIPS LED status indicators
F	Indicates marriage status. In full power mode, a green LED indicates the projector is properly married and encrypted content can be displayed. A red LED indicates marriage is broken and encrypted content cannot be displayed.
G	Resets the projector electronics. After restarting, the projector returns to its previous power mode.

H	Projector LED status indicators
I	LED status indicators
J	Connects the projector to 3D devices.
K	Connects the projector to ingest devices.
L	Connects the projector to input devices with an HDMI connection.
M	Connects the projector to external automation or automation devices.
N	Connects the projector to the touch panel (VGA-Out and Screen Power).
O	Management Ethernet port (10/100/1000 base-T) and connects the projector to USB devices, including the touch panel screen.
P	Two Ethernet ports connecting the projector to network-attached storage (NAS) devices and the Library Media Server (LMS) network, if applicable. The Media port can also be used for content transfer.

Projector LED status indicators

Identify the LED state colors and meaning.

LEDs	State		Description
Green	Flashes once per second	Standby mode	Light source is off. Video electronics are off. Projector status is OK.
	Flashes three times per second	Warm up	Projector is moving to light source on state. Light source is warming up. Video electronics are initializing.
	Solid	Startup	The power is on and the lamp is on or off
Yellow	Flashes once per second	Notification	A problem exists with the projector that does not prevent it from operating.
	Flashes three times per second	Non-critical alarm	A problem exists with the projector that does not prevent it from operating.
Red	Flashes three times per second	Unacknowledged critical error	An error with the projector exists and has not been acknowledged.
	Solid	Acknowledged critical error	An error with the projector exists and has been acknowledged.

SM and FIPS LED status indicators

Identify the LED state colors and meaning.

LED	Color	State	Description
SM	Green	Flashing	The security manager (SM) is running correctly.
FIPS	Green	Solid	FIPS (Federal Information Processing Standards Publication) security status is operating correctly.

LED	Color	State	Description
	Red	Solid	An error has occurred. Restart the Christie Integrated Media Block (IMB). If the LED remains red, return the Christie IMB to Christie

LED status indicators

Identify the LED state colors and meaning.

LED	Color	Description
HUB	Green	FPGA video processing is running correctly.
	Orange	FPGA video processing is not configured.
	Red	A failure exists with the FPGA video processing.
SMS	Green	Screen management system (SMS) is running correctly.
	Orange	The SMS or system controller has not booted.
	Red	A failure exists with the SMS or system controller.
INPUT	Green	FPGA video input is running correctly.
	Orange	FPGA video input is not configured.
	Red	A failure exists with the FPGA video input.
Power	Green	The low voltage power supply (LVPS) is operating.
	Red	A failure exists with the LVPS.
	No LED	The LED is not illuminated when the LVPS is not on.

Connecting the projector to a network

The CP2309-RGB projectors can be connected to various media devices and wired networks.

For detailed information on connecting the projector to a device or network, see the *CP2309-RGB User Guide (P/N: 020-103081-XX)*.

Connecting the devices to the 3D port

For information on connecting devices to the 3D port on the projector, refer to the product documentation for the device you are using.

Managing the light source

Learn how to configure a laser file and use the projector's LiteLOC™ feature.

Use the laser file to control the power settings of the red, green, and blue (RGB) lasers. The LiteLOC™ feature ensures that color and brightness are held at the level you set.

Create multiple laser files to manage varying screen sizes, brightness requirements, room temperatures in the projection booth, and types of content (such as 2D, 3D, and alternative content).

Creating a new laser file

Create a laser file to store the power settings for the RGB laser light source and the maximum expected room temperature for the projection booth.

The maximum (MAX) power limit for Red and Green changes according to the value set for the maximum expected room temperature. For Red, Green, and Blue power levels, system stability may be affected if levels are set below the minimum (MIN) power limit shown.

To make sure color and brightness are held at the required levels for your installation, Christie recommends enabling LiteLOC™ for each laser file you create.

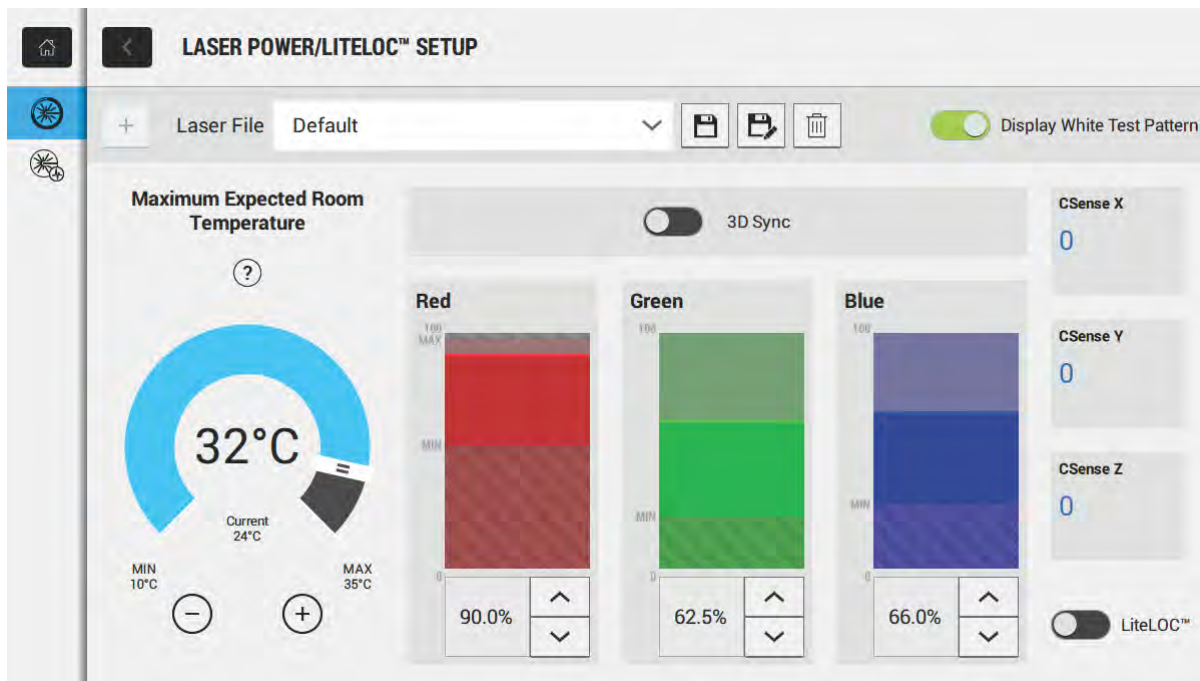

When refining the laser power settings, the amount of time required to re-stabilize the projector depends on the size of the adjustment. For small adjustments to the expected room temperature or

power settings, the projector requires only 1 or 2 minutes to re-stabilize. For larger adjustments, the projector may require up to 15 minutes to re-stabilize.

1. In the left navigation pane, select **Laser Settings > Laser Power/LiteLOC Setup**.
2. To activate the controls, select the **Display White Test Pattern** slider.
3. To create a new laser file, select **Create**. 
4. In the Create dialog, enter a name for the new laser file and select **Create**.
5. If the laser file will be associated with a 3D channel, select the **3D Sync** slider.
6. Under Maximum Expected Room Temperature, select the plus and minus signs (or drag the temperature slider) to indicate the maximum expected room temperature in the projection booth.

The system uses the maximum expected room temperature to calculate the light output. The default maximum expected room temperature setting is 25°C (77°F). A lower room temperature generally results in increased brightness and better efficiency. A higher room temperature reduces the maximum power setting available for the lasers. The maximum expected room temperature setting must reflect actual operating conditions.



If you set a maximum expected room temperature below the existing ambient room temperature, the system displays a warning.

7. Set the approximate Red, Green, and Blue power levels as required for your projection environment and allow the projector to stabilize for 15 minutes.
System stability may be affected if you set a power level below the minimum power level recommended.
When setting the Red or Green power level, Christie recommends setting a level below the maximum (MAX) limit shown. A value below the maximum limit ensures an optimal brightness that can be maintained over time.
8. If color or brightness is not at the target level, refine the Red, Green, and Blue power settings to achieve the target, and then allow the projector to re-stabilize for an additional 3 to 5 minutes.



The projector is considered stable when there are no further adjustments and you obtain the same screen state results after two sets of measurements, 5 minutes apart.

9. Once the correct color and brightness are achieved and the projector has stabilized, select the **LiteLOC** slider to lock the settings.
The color of the slider turns to green to indicate the settings are locked. The projector's LiteLOC™ system maintains the brightness and color levels.
 10. To save the new laser file, select **Save**. 
- Color sensor (CSense) data are displayed on the interface to provide feedback on the current color sensor information.

Modifying an existing laser file

Modify the settings in the laser file to change the laser power settings or the maximum expected room temperature.

When refining the laser power settings, the amount of time required to re-stabilize the projector depends on the size of the adjustment. For small adjustments to the expected room temperature or

power settings, the projector requires only 1 or 2 minutes to re-stabilize. For larger adjustments, the projector may require up to 15 minutes to re-stabilize.

1. Log in as service.
2. Turn on the laser.
3. Display a test pattern, such as DC4K 17 L Point, to locate the center of the screen.
4. In the left navigation menu, select **Laser Settings > Laser Power/LiteLOC Setup**.
5. To begin modifying the settings, select **Display White Test Pattern**.
6. From the Laser File list, select the laser file to edit.
7. Adjust the Maximum Expected Room Temperature.
8. In the White Coordinates dialog, set the required white point.
For a typical cinema setup, the white point is DCI white $x=0.314$ and $y=0.351$.
9. Select **Apply**.
10. Set the brightness levels as required for your projection environment and allow the projector to stabilize for a few minutes.
System stability may be affected if you set a power level below the minimum power level recommended.
11. If white or brightness is not at the target level, adjust the settings to achieve the target and allow the projector to re-stabilize for an additional three to five minutes.



The projector is considered stable when no further adjustments are required and you obtain the same screen state results after two sets of measurements, five minutes apart.

12. To save the new settings, select **Save**. 

Copying existing laser settings to a new file

Copy an existing laser file when creating a new file with similar settings.

1. In the left navigation menu, select **Laser Settings > Laser Power/LiteLOC Setup**.
2. Select the **Display White Test Pattern** slider.
3. From the Laser File list, select the file to copy.
4. To save the new laser file, select **Save As**. 
5. Enter a new name for the laser file and then select **Save**.
6. Adjust the settings as required for the new configuration.
7. Select **Save**.

Deleting a laser file

Delete a laser file when the configuration is no longer required.

1. In the left navigation menu, select **Laser Settings > Laser Power/LiteLOC Setup**.
2. Select the **Display White Test Pattern** slider.
3. In the Laser File list, select the file to delete.

4. Select **Delete**. 
5. To confirm the deletion, select **Delete**.

Adjusting the image

Learn how to adjust image geometry so it displays correctly.

Calibrating the Intelligent Lens System

On CP2309-RGB projectors, the Intelligent Lens System (ILS) is activated by default.

Use the Auto Calibrate feature of the ILS to find and compensate for motor backlash, and to determine the movement range for the currently installed lens.

1. In the left navigation menu, select **Image Settings > ILS File Setup**.
2. From the ILS File list, select an available ILS file.
3. Select **Auto Calibrate**.
4. Select **Continue**.
The system performs the lens calibration.

Correcting vignetting

An image that is brighter at the center than it is at the sides needs vignetting correction.

If your image suffers from vignetting, the lens has reached the end of its offset travel range.

If your installation does not allow the image to be centered with the center of the screen, move the entire projector in the direction of lens travel.

Adjusting tilt and leveling the projector

To ensure optimum performance, install the projector so it is centered and parallel with the screen.

To compensate for tilt or offset, you can adjust the projector feet and the lens mount position.

1. To adjust the height of the projector, loosen the lock nut on the adjustable feet on the bottom of the projector.

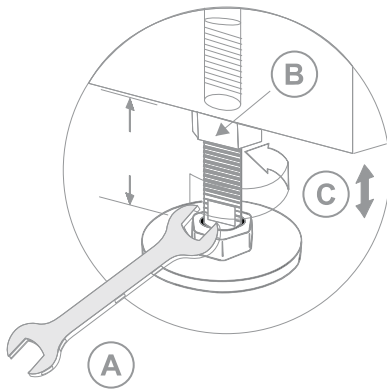

A	19 mm (0.75 in.) wrench
B	Lock
C	Turn to adjust height

2. Extend or retract the feet.
3. When the adjustment is correct, tighten the lock nut.

Correcting keystone effect

Keystone effect occurs when you project an image onto the screen at an angle. As a result, the image appears distorted and resembles a trapezoid.



When making the adjustments, set the light source to minimum power.

Horizontal keystone	Vertical keystone
Projector skewed horizontally to the screen	Projector tilted vertically to the screen

1. If the image suffers from slight keystone effect, it can be corrected with electronic cropping.
2. If the keystone effect is severe, unevenly adjust the feet to compensate for projector tilt.

Christie recommends using the lens offset to align the center of the image to the center of the screen before correcting the keystone effect.

3. If one side of the image is longer than another, adjust the tilt and level of the projector.

Displaying a test pattern

Display a test pattern to refine and adjust the projected image or to diagnose and correct image issues.

1. In the right toolbar, select **Test Patterns**. 
2. Select **Full Screen**.
3. Select a test pattern.
When a test pattern is active, a blue bar appears below the test pattern icon in the right pane.
4. To display a 2D test pattern in 3D mode, select the **3D Sync** option.
The **3D Sync** option is selected automatically for 3D test patterns. 3D test patterns cannot be displayed in 2D mode.
5. To change the frame rate of the test pattern display, select from the available Frame Rate options:
 - For 2D test patterns, the available frame rates are 24, 30, 48, and 60 Frames Per Second (FPS). The default value is 24 FPS.
 - For 3D test patterns, the available frame rates are 48 and 60 FPS. The default value is 48 FPS.

Changing the frame rate of the display can assist with color measurement when working with corrected colors.

When changing the frame rate option, the option is applied to the next test pattern you select unless it is not available for that pattern. If a selected frame rate is not available, the default frame rate is applied for the test pattern display.

Adjusting the integrator rod and fold mirror

Extreme misalignment of projection optics can cause permanent damage to critical optical components. Only Christie qualified technicians can perform internal optical adjustments.



Notice. If not avoided, the following could result in property damage.

- Misalignment of the fold mirror may cause permanent damage to the product.
1. From the Test Pattern menu, select **RGB-2K-Integrator Rod**.
The test pattern includes guided information for integrator focus and rotation adjustments.

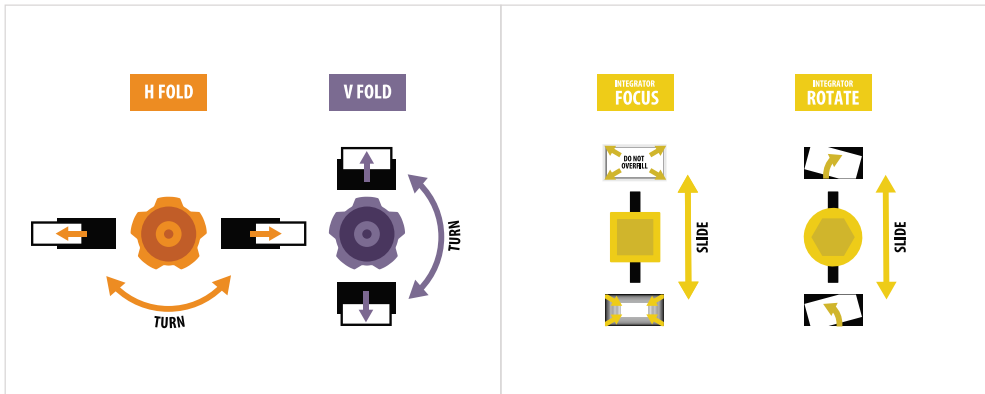

2. Set the projector brightness level to approximately 50% to 60%.
3. Retrieve the 3 mm hex driver supplied with the projector.
4. Remove the top cover of the projector.
5. Loosen the two integrator lock screws.

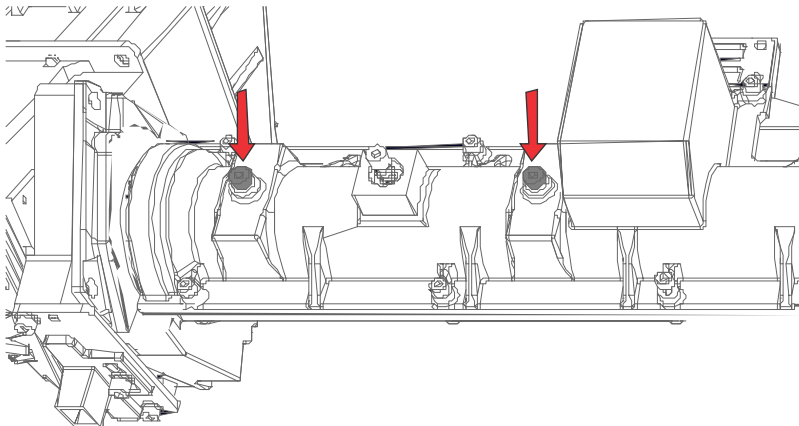

6. Loosen the lock screw located next to the Focus adjustment slider.

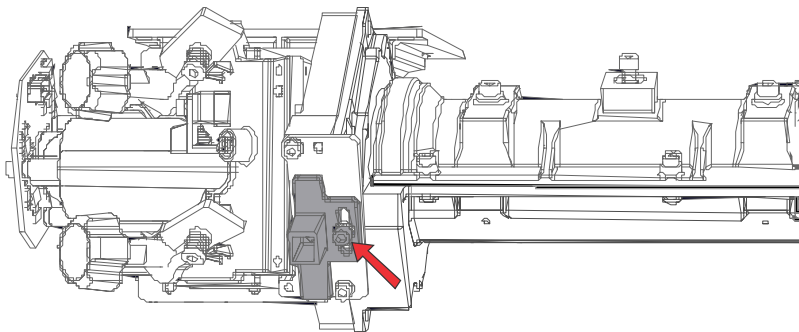

7. Unlock the fold mirror screws to unlock the adjustment knobs.

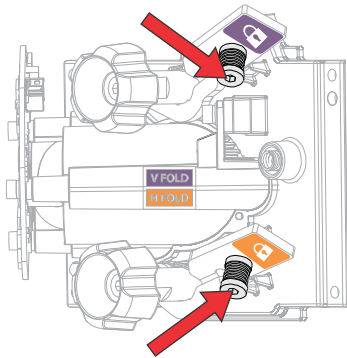

8. Using the V FOLD (purple) adjustment knob on the fold mirror, lower the image to expose the top of the active light area.
9. Using the Focus slider on the integrator, focus the top of the image at the center or slightly left of center.

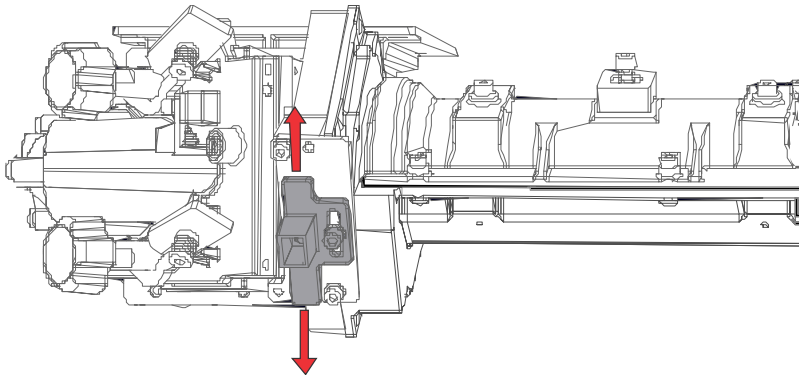

10. Using the V FOLD and H FOLD adjustment knobs on the fold mirror, bring the image back up and fill the active light area.
11. Using the Rotate slider on the integrator, rotate the integrator to reduce shadows in the image.

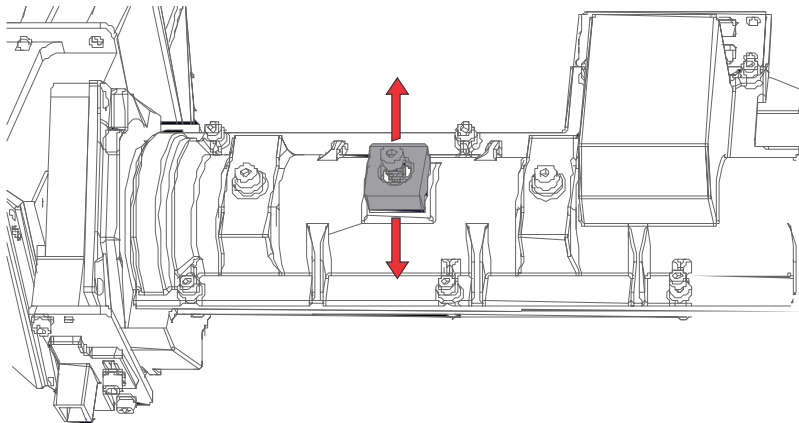

12. Check the image quality.
13. As required to fill the image, make fine adjustments to the fold mirror, integrator rotation, and integrator focus.
14. When the correct image quality is achieved, tighten all screws to hold the adjustments:

- The two integrator lock screws on the integrator.
- The Focus slider lock screw on the integrator.
- The V FOLD and H FOLD screws on the fold mirror.

15. Re-install the top cover of the projector.

Adjusting vertical boresight

Perform a top and bottom boresight adjustment to fix image focus issues that cannot be corrected by aligning the projector to the screen and focusing the lens.



Caution! If not avoided, the following could result in minor or moderate injury.

- This procedure must be performed by Christie qualified technicians.

Make sure the projector is perpendicular to the screen before adjusting boresight.

Christie recommends completing a top and bottom boresight adjustment before adjusting the horizontal boresight.

A boresight adjustment should only be made when the image cannot be focused uniformly on the screen by aligning the projector to the screen and focusing the lens. When adjusting boresight, you must maintain the boresight distance from the lens to the prism plane set by Christie. For example, when you move the top screw outward, turn the bottom two boresight screws to maintain the overall distance.

Make sure the boresight lockdown screws are adequately tightened. Inadequately tightening the boresight screws can result in excessive on-screen image vibration. After adjusting boresight, evaluate the on-screen image vibration and re-adjust if needed.

1. Remove the lens surround.
2. Display the DC2K Boresight test pattern.
3. Loosen the set screw (B in the image below).

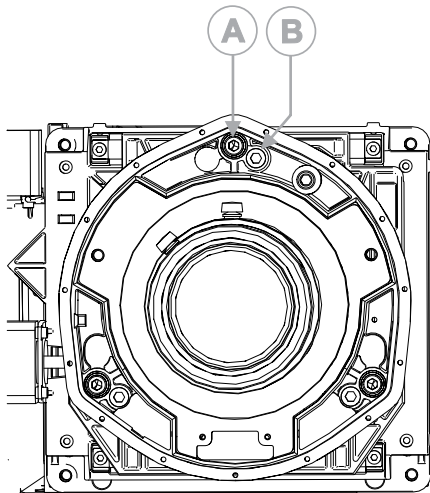

4. Turn the vertical cap screw (A in the image in step 3) 1/8 of a turn counter-clockwise. Only adjust vertical boresight 1/8 of a turn or less at one time to maintain optimal lens performance (factory setup of absolute lens distance to the prism). You must count each turn of the cap screws to ensure accurate adjustment.

5. Adjust both left and right horizontal adjusters by half the number of turns, in the opposite direction of the vertical adjust.
For example, if the vertical adjust cap screw was turned 1/8 of a turn, the left and right horizontal cap screws should be turned 1/16 of a turn in the opposite direction.
6. Check the screen each time an adjustment is made.
If the quality of the projected image has degraded, turn the vertical adjust cap screw 1/8 of turn clockwise.
Make sure the left and right horizontal adjusters are adjusted equally in the opposite direction to correct axial focus. The 1/8 of a turn is a suggestion only and can be less if needed; however, never exceed it. Always compensate both left and right horizontal adjustments according to the vertical adjustment.
7. Check the image after each adjustment.
8. Continue to make adjustments until both top and bottom are equally sharp.
To make sure the lens is in the same relative position, adjust the left and right horizontal adjusters in the opposite direction at the same time.
9. When the top and bottom of the image are equally in focus lock the set screw to hold it in position.
10. Recheck the image.
11. If additional adjustment is required, try adjusting horizontal boresight.
12. Replace the lens surround.

Adjusting horizontal boresight

Perform a horizontal boresight adjustment when the image cannot be focused uniformly on the screen by aligning the projector to the screen and focusing the lens.



Caution! If not avoided, the following could result in minor or moderate injury.

- This procedure must be performed by Christie qualified technicians.

Typically, horizontal boresight does not require adjustment. It should only be adjusted if a large horizontal angular offset to the screen is required.

When adjusting boresight, you must maintain the boresight distance from the lens to the prism plane set by Christie. For example, when you move the top screw outward, turn the bottom two boresight screws to maintain the overall distance.

Only adjust horizontal boresight 1/8 of a turn or less at one time to maintain optimal lens performance (factory setup of absolute lens distance to the prism). You must count each turn of the cap screws to ensure accurate adjustment.

Make sure the boresight lockdown screws are adequately tightened. Not adequately tightening the boresight screws can result in excessive on-screen image vibration. After adjusting boresight, evaluate the on-screen image vibration and re-adjust if needed.

1. Remove the lens surround.
2. Display the DC2K Boresight test pattern.
3. Loosen the right boresight set screw (B in the image below).

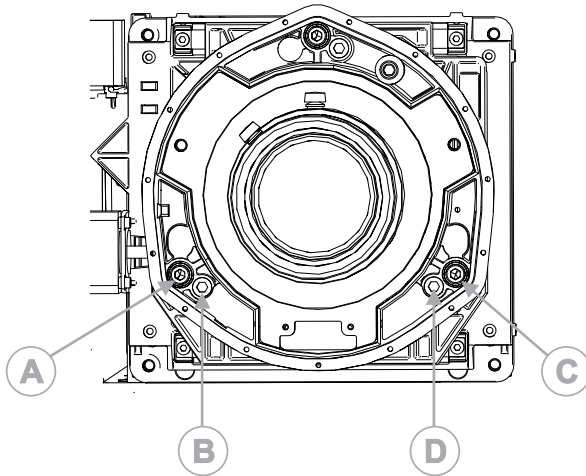

- A Right boresight cap screw
- B Right boresight set screw
- C Left boresight cap screw
- D Left boresight set screw

4. Turn the right boresight cap screw (A in the image in step 3) 1/16 of a turn clockwise.
5. Adjust the left boresight cap screw (C in the image in step 3) equally in the opposite direction.
6. If the quality of the projected image has not improved, turn the right boresight cap screw 1/16 of turn counter-clockwise.
Make sure the left adjuster is adjusted equally in the opposite direction.
7. Check the screen each time an adjustment is made.
The right-side adjustments affect the top right and bottom left points on the screen.
8. Once both cross hairs are in focus, lock the set screw for right boresight.
9. Repeat steps 5 to 8 for the left side.
10. Verify each corner of the screen is equally in focus.
If this is not the case, try adjusting vertical boresight.

Adjusting digital micromirror device (DMD) convergence

A convergence problem occurs when one or more projected colors (red, green, blue) appears misaligned when examined with a convergence test pattern.

Normally, the three colors should overlap precisely to form pure white lines throughout the image and one or more poorly converged individual colors may appear adjacent to some or all of the lines.

Contact your Christie qualified service technician to correct digital micromirror device (DMD) convergence issues.

Correcting on-screen color

After installation, further image adjustments may be required to correct color on the screen.

The next steps may include creating a Measured Color Gamut Data (MCDG) file and configuring a Pureformity Color™ Technology (PCT) file to achieve optimal color and brightness uniformity.

For more information on managing color settings, see the *CP2309-RGB User Guide (P/N: 020-103081-XX)*.

Regulatory

This product conforms to the latest regulations and standards related to product safety, environmental, and electromagnetic compatibility (EMC) requirements.

Safety

- ANSI/UL 60950-1 – Information Technology Equipment – Safety – Part 1: General Requirements
- CAN/CSA C22.2 No. 60950-1-07 – Information Technology Equipment – Safety – Part 1: General Requirements
- IEC/EN 60825-1 – Safety of Laser Products – Part 1: Equipment Classification and Requirements
- IEC/EN 60950-1 – Information Technology Equipment – Safety – Part 1: General Requirements
- IEC/EN 62471-5 – Photobiological Safety of Lamps and Lamp Systems – Part 5: Image projectors

Electro-magnetic compatibility

Emissions

- CAN ICES-003 (A)/NMB-003 (A) – Information Technology Equipment (Including Digital Apparatus) – Limits and Methods of Measurement
- CISPR 32:2012/EN 55032:2012, Class A – Electromagnetic Compatibility of Multimedia Equipment – Emission Requirements
- FCC CFR47, Part 15, Subpart B, Class A – Unintentional Radiators
- IEC 61000-3-2/EN61000-3-2: Limits for harmonic current emissions for equipment with input current ≤ 16 A
- IEC 61000-3-3/EN61000-3-3: Limitations of Voltage Changes, Voltage Fluctuations, and Flicker input current ≤ 16 A

Immunity

- CISPR 24:2010/EN55024:2010 EMC Requirements – Information Technology Equipment – Immunity Characteristics – Limits and Methods of Measurements

Environmental

- China Ministry of Information Industry (along with 7 other Government Agencies) Order No.32 (01/2016) on the control of pollution caused by electronic information products, hazardous

substances concentration limits (GB/T 26572 - 2011), and the applicable product marking requirement (SJ/T 11364 - 2014).

- EU Directive (2011/65/EU) on the restriction of the uses of certain hazardous substances (RoHS) in electrical and electronic equipment and the applicable official amendment(s).
- EU Directive (2012/19/EU) on waste and electrical and electronic equipment (WEEE) and the applicable official amendment(s).
- Regulation (EC) No. 1907/2006 on the registration, evaluation, authorization and restriction of chemicals (REACH) and the applicable official amendment(s).

International packaging recycling mark requirements.

- EU Directive (94/62/EC) on packaging and packaging waste
- China packaging recycling mark standard (GB18455-2001)
- EU Directive (2012/19/EU) on waste and electrical and electronic equipment (WEEE) and the applicable official amendment(s).

