The top half of the page features a complex, abstract background of overlapping, semi-transparent blue triangles and polygons in various shades of blue, creating a dynamic, crystalline effect. This pattern tapers off towards the bottom, meeting a white background.

User Guide  
020-103949-01

# CineLife+ 2K

**CHRISTIE®**

## NOTICES

### COPYRIGHT AND TRADEMARKS

Copyright © 2024 Christie Digital Systems USA Inc. All rights reserved.

All brand names and product names are trademarks, registered trademarks or trade names of their respective holders.

### GENERAL

Every effort has been made to ensure accuracy, however in some cases changes in the products or availability could occur which may not be reflected in this document. Christie reserves the right to make changes to specifications at any time without notice. Performance specifications are typical, but may vary depending on conditions beyond Christie's control such as maintenance of the product in proper working conditions. Performance specifications are based on information available at the time of printing. Christie makes no warranty of any kind with regard to this material, including, but not limited to, implied warranties of fitness for a particular purpose. Christie will not be liable for errors contained herein or for incidental or consequential damages in connection with the performance or use of this material. Our centers of excellence for manufacturing in Kitchener, Ontario, Canada and in Shenzhen, China are ISO 9001:2015 Quality Management System-certified.

Christie is committed to making our documents free from language bias; however, we are not responsible for the language used on any linked or third-party documentation.

For the most current technical documentation and office contact information, visit <https://www.christiedigital.com/>.

### Warranty

Products are warranted under Christie's standard limited warranty, the details of which are available at <https://www.christiedigital.com/help-center/warranties/> or by contacting your Christie dealer or Christie.

### PREVENTATIVE MAINTENANCE

Preventative maintenance is an important part of the continued and proper operation of your product. Failure to perform maintenance as required, and in accordance with the maintenance schedule specified by Christie, voids the warranty. For preventative maintenance schedules, refer to [www.christiedigital.com](http://www.christiedigital.com).

### REGULATORY

The product has been tested and found to comply with the limits for a Class A digital device, pursuant to Part 15 of the FCC Rules. These limits are designed to provide reasonable protection against harmful interference when the product is operated in a commercial environment. The product generates, uses, and can radiate radio frequency energy and, if not installed and used in accordance with the instruction manual, may cause harmful interference to radio communications. Operation of the product in a residential area is likely to cause harmful interference in which case the user will be required to correct the interference at the user's own expense. Changes or modifications not expressly approved by the party responsible for compliance could void the user's authority to operate the equipment

CAN ICES-3 (A) / NMB-3 (A)

이 기기는 업무용(A급)으로 전자파적합등록을 한 기기이오니 판매자 또는 사용자는 이점을 주의하시기 바라며, 가정 외의 지역에서 사용하는 것을 목적으로 합니다.

### ENVIRONMENTAL



The product is designed and manufactured with high-quality materials and components that can be recycled and reused. This symbol  means electrical and electronic equipment, at their end-of-life, should be disposed of separately from regular waste. Please dispose of the product appropriately and according to local regulations. In the European Union, separate collection systems are for used electrical and electronic products.

If printing this document, consider printing only the pages you need and select the double-sided option.

Please help us to conserve the environment we live in!

### Notation

Learn the hazard and information symbols used in the product documentation.



Danger messages indicate a hazardous situation which, if not avoided, results in death or serious injury.



Warning messages indicate a hazardous situation which, if not avoided, could result in death or serious injury.



Caution messages indicate a hazardous situation which, if not avoided, could result in minor or moderate injury.



Notice messages indicate a hazardous situation which, if not avoided, may result in equipment or property damage.



Information messages provide additional information, emphasize or provide a useful tip.

# Content

<b>Introduction. . . . .</b>	<b>9</b>
Models. . . . .	9
Product documentation. . . . .	9
Safety precautions. . . . .	10
General safety precautions. . . . .	10
AC power precautions. . . . .	10
Laser safety precautions. . . . .	11
Light intensity hazard distance. . . . .	11
CineMaster cinema calculator tool. . . . .	13
Technical support. . . . .	13
Contact your dealer. . . . .	13
<b>Operating the projector. . . . .</b>	<b>14</b>
Projector power modes. . . . .	14
Turning on or off the projector. . . . .	15
LED status indicators. . . . .	15
Logging into the projector. . . . .	15
Logging out of the projector. . . . .	16
Changing the session timeout. . . . .	16
Determining the projector IP address. . . . .	16
Resetting the projector IP address to the default. . . . .	17
Using the web user interface (Web UI). . . . .	18
Turning on or off the touch panel. . . . .	18
Understanding the Christie touch panel interface and web user interface. . . . .	19
Turning on or off the light source. . . . .	20
Opening or closing the shutter. . . . .	20
Adding a network time protocol server. . . . .	21
Deleting a network time protocol server. . . . .	21
Changing the time zone. . . . .	21
Changing the time format. . . . .	22
Changing the orientation of the projected image. . . . .	22
Changing the projector hostname. . . . .	22
Changing the temperature display. . . . .	23
Disabling serial authentication requirement. . . . .	23

Viewing system status information. . . . . 23

**Video Input panel. . . . . 24**

    HDMI video source. . . . . 25

        HDMI video formats. . . . . 25

    Integrated Media Block (IMB) video source. . . . . 26

        Series 2 Integrated Media Block (IMB) video formats. . . . . 27

        Series 4 Integrated Media Block (IMB) video formats. . . . . 29

        HDMI video source connection from an Integrated Media Block (IMB). . . . . 33

        SDI video source connection from an Integrated Media Block (IMB). . . . . 33

    GPIO connector. . . . . 34

**Hibernate mode. . . . . 37**

    Enabling hibernate mode. . . . . 37

    Waking up from hibernate mode. . . . . 37

**Managing the light source. . . . . 39**

    Creating a new laser file. . . . . 39

    Modifying an existing laser file. . . . . 40

    Copying existing laser settings to a new file. . . . . 40

    Deleting a laser file. . . . . 41

    LiteLOC™ sensor-to-screen calibration . . . . . 41

        LiteLOC™ sensor-to-screen calibration: Workflow. . . . . 41

        Creating a new calibration file. . . . . 42

        Recalibrating an existing calibration file. . . . . 43

        Editing the existing calibration file parameters. . . . . 44

        Verifying the sensor-to-screen calibration . . . . . 44

        Adding a calibration file to the Channel Setup. . . . . 45

**Managing user accounts. . . . . 46**

    Default user access permissions. . . . . 46

    Adding a user account. . . . . 46

    Changing user account permissions. . . . . 46

    Changing a user account password. . . . . 47

    Deleting a user account. . . . . 47

**Network settings. . . . . 48**

    Connecting the projector to the theater network. . . . . 48

    Activating SNMP. . . . . 48

    Downloading MIB information. . . . . 49

**Managing content, playlists, and storage. . . . . 50**

**Setting up an integrated media block. . . . . 51**

    Selecting Integrated Media Block (IMB) preferences. . . . . 51

    Activating marriage. . . . . 51

    Enabling Integrated Media Block (IMB) Powered in Standby mode. . . . . 51

**Working with channels. . . . . 53**

    Adding a channel for HDMI input. . . . . 53

    Adding a channel for Integrated Media Block (IMB) input. . . . . 54

    Selecting the active channel. . . . . 55

    Editing an existing channel. . . . . 56

    Renaming a channel. . . . . 56

    Copying existing channel settings to a new channel. . . . . 56

    Viewing the channel list. . . . . 56

    Moving a channel up or down the channel list. . . . . 57

    Deleting a channel. . . . . 57

**Managing color setting files. . . . . 58**

    Creating an MCGD file. . . . . 58

        Editing an existing MCGD file. . . . . 58

        Copying existing MCGD file settings to a new file. . . . . 59

        Deleting an MCGD file. . . . . 59

    Creating a TCGD file. . . . . 59

        Editing an existing TCGD file. . . . . 60

        Copying existing TCGD file settings to a new file. . . . . 60

        Deleting a TCGD file. . . . . 60

**Adjusting the image size and position. . . . . 61**

    Intelligent Lens System (ILS). . . . . 61

        Activating the Intelligent Lens System. . . . . 61

        Creating a new ILS file. . . . . 61

        Automatically calibrating the ILS. . . . . 62

        Editing ILS file settings. . . . . 62

        Copying existing ILS file settings. . . . . 62

        Deleting an ILS file. . . . . 62

        Resetting the lens. . . . . 62

    Electronic Color Correction (ECC). . . . . 63

        Electronically adjusting convergence. . . . . 63

Creating a source file. . . . .	65
Editing source file settings. . . . .	65
Copying existing source file settings to a new source file. . . . .	65
Deleting a source file. . . . .	65
Creating a screen file. . . . .	66
Editing screen file settings. . . . .	66
Copying existing screen file settings to a new screen file. . . . .	67
Deleting a screen file. . . . .	67
Activating a warp file. . . . .	67
<b>Adjusting the image. . . . .</b>	<b>68</b>
Correcting vignetting. . . . .	68
Correcting keystone effect. . . . .	68
Masking the screen edges. . . . .	69
<b>Test patterns. . . . .</b>	<b>71</b>
Displaying a test pattern. . . . .	71
Turning off a test pattern. . . . .	71
Importing a test pattern. . . . .	72
Deleting a test pattern. . . . .	72
<b>Working with the scheduler. . . . .</b>	<b>73</b>
Scheduling automation. . . . .	73
Editing a scheduled event. . . . .	73
Copying and pasting an existing scheduled event. . . . .	74
Copying and pasting scheduled events for an entire day. . . . .	74
Cutting and pasting a scheduled event. . . . .	74
Deleting a scheduled event. . . . .	75
Deleting scheduled events for an entire day. . . . .	75
Changing the day of the week the scheduler starts. . . . .	75
Turning off the scheduler. . . . .	75
<b>Automation. . . . .</b>	<b>76</b>
Available macro actions. . . . .	76
Fire alarm macro. . . . .	77
Christie ACT actions. . . . .	77
JNIOR actions. . . . .	77
Dolby cinema processor actions. . . . .	78
SKA-3D actions. . . . .	78

Creating a macro. . . . .	79
Running a macro. . . . .	79
Adding an action item to an existing macro. . . . .	79
Adding a macro to an existing macro. . . . .	80
Deleting a macro. . . . .	80
Creating, editing, and deleting playlist triggers. . . . .	80
Creating a new global trigger. . . . .	80
Editing existing global trigger settings. . . . .	81
Deleting a global trigger. . . . .	81
Adding an automation device to your auditorium. . . . .	81
Modifying automation device settings. . . . .	82
Removing an automation device from your auditorium. . . . .	82
Importing a device library. . . . .	82
Viewing a device library. . . . .	82
Deleting a device library. . . . .	83
<b>Rental mode. . . . .</b>	<b>84</b>
Applying a rental mode license file. . . . .	84
Viewing rental mode license expiry. . . . .	84
<b>Backing up, restoring, and upgrading files. . . . .</b>	<b>85</b>
Creating a new backup file. . . . .	85
Downloading a backup file. . . . .	85
Importing a backup file. . . . .	85
Sorting backup files by name and date created. . . . .	86
Deleting a backup file. . . . .	86
Restoring settings from a backup file. . . . .	86
Restoring factory default settings. . . . .	86
Upgrading the projector software. . . . .	86
<b>Accessing projector diagnostics. . . . .</b>	<b>88</b>
Retrieving and downloading system logs. . . . .	88
Running the projector interrogator. . . . .	88
Viewing laser diagnostic information. . . . .	89
Downloading a certificate. . . . .	89
<b>Regulatory. . . . .</b>	<b>90</b>
Safety. . . . .	90
Electro-magnetic compatibility. . . . .	90

---

Emissions. . . . .	90
Immunity. . . . .	90
California law on security. . . . .	91
Environmental. . . . .	91



# Introduction

This manual is intended for operators of Christie CineLife+ 2K projection systems.  
For complete product documentation and technical support, go to [www.christiedigital.com](http://www.christiedigital.com).

## Models

This guide applies to the following models.

- CP2406-RBe
- CP2409-RBe
- CP2411-RBe

## Product documentation

For installation, setup, and user information, see the product documentation available on the Christie Digital Systems USA Inc. website. Read all instructions before using or servicing this product.

1. Access the documentation from the Christie website:
  - Go to this URL: <https://bit.ly/3vxrm4Y> or <https://www.christiedigital.com/products/cinema/projection/cinelif-plus-series/>.
  - Scan the QR code using a QR code reader app on a smartphone or tablet.



2. On the product page, select the model and switch to the **Downloads** tab.

# Safety precautions

Learn about the safety precautions related to the Christie CineLife+ 2K projector. This projector is intended for use in a cinema environment.

## General safety precautions

Read all safety and warning guidelines before installing or operating the projector.



**Warning!** If not avoided, the following could result in death or serious injury.

- TRIP OR FIRE HAZARD! Position all cables where they cannot contact hot surfaces, be pulled, be tripped over, or damaged by persons walking on or objects rolling over the cables.
- This product must be installed within a restricted access location not accessible by the general public.
- Only personnel who are trained on the precautions for the restricted access location can be granted entry to the area.
- Install the product so users and the audience cannot enter the restricted area at eye level.
- ELECTRICAL and BURN HAZARD! Use caution when accessing internal components.
- High leakage current present when connected to IT power systems.
- FIRE AND SHOCK HAZARD! Use only the attachments, accessories, tools, and replacement parts specified by Christie.
- FIRE HAZARD! Do not use a power cord, harness, or cable that appears damaged.
- Do not install or operate the projector in any position that does not meet the stated product specifications for alignment and orientation.



**Caution!** If not avoided, the following could result in minor or moderate injury.

- Only Christie qualified technicians are permitted to open product enclosures.

## AC power precautions

Read all safety and warning guidelines before connecting to AC power.



**Warning!** If not avoided, the following could result in death or serious injury.

- SHOCK HAZARD! Only use the AC power cord provided with the product or recommended by Christie.
- FIRE AND SHOCK HAZARD! Do not attempt operation unless the power cord, power socket, and power plug meet the appropriate local rating standards.
- SHOCK HAZARD! Do not attempt operation if the AC supply is not within the specified voltage and current, as specified on the license label.
- SHOCK HAZARD! The optional UPS power cord must be inserted into an outlet with grounding.
- SHOCK HAZARD! Disconnect the product from AC before installing, moving, servicing, cleaning, removing components, or opening any enclosure.
- Install the product near an easily accessible AC receptacle.



**Caution!** If not avoided, the following could result in minor or moderate injury.

- FIRE HAZARD! Do not use a power cord, harness, or cable that appears damaged.
- FIRE OR SHOCK HAZARD! Do not overload power outlets and extension cords.
- SHOCK HAZARD! Power supply uses double pole/neutral fusing.

## Laser safety precautions

Read all safety and warning guidelines before operating the projector laser.



**Warning!** If not avoided, the following could result in death or serious injury.

- Do not operate the cinema projector without all of its covers in place.
- LASER RADIATION HAZARD! This projector has a built-in Class 4 laser module. Never attempt to disassemble or modify the laser module.
- Do not look directly into the lens when the light source is on. The extremely high brightness can cause permanent eye damage.
- Possible hazardous optical radiation emitted from this product. (Risk group 3)

## Light intensity hazard distance

This projector has been classified as Risk Group 3 as per the IEC 62471-5:2015 standard due to possible hazardous optical and thermal radiation being emitted.



**Warning!** If not avoided, the following could result in serious injury.

- PERMANENT/TEMPORARY BLINDNESS HAZARD! No direct exposure to the beam must be permitted.
- PERMANENT/TEMPORARY BLINDNESS HAZARD! Operators must control access to the beam within the hazard distance or install the product at the height that prevents exposure of spectators' eyes within the hazard distance. The hazard zone must be no lower than 2.5 meters/8.2 feet (US installations) or 2.0 meters/6.6 feet (global installations) above any surface upon which any persons are permitted to stand and the horizontal clearance to the hazard zone must be a minimum 1.0 meters (3.3 feet).
- EXTREME BRIGHTNESS! Do not place reflective objects in the product light path.

The following show the zones for ocular and skin hazard distances.

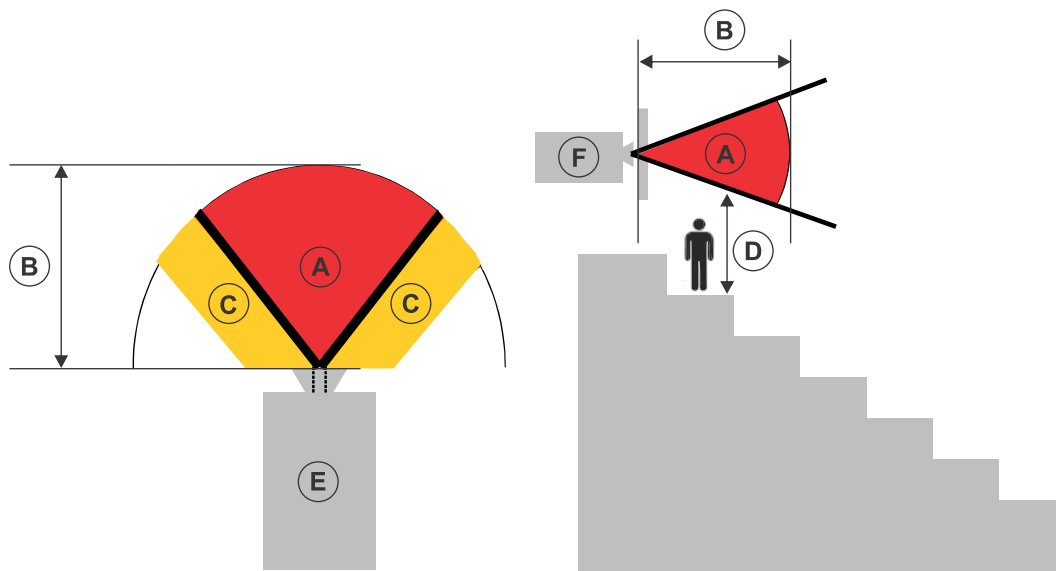

- A—Hazard zone. The region of space where the projection light from the laser-illuminated projector is above emission limits for Risk Group 2. The light intensity may cause eye damage after a momentary or brief exposure (before a person can avert their eyes away from the light source). The light may cause skin burns to occur.
- B—Hazard distance. Operators must control access to the beam within the hazard distance or install the product preventing potential exposure of the spectators' eyes from being in the hazard distance.
- C—No access zone. Horizontal clearance of the no access zone must be a minimum of 1.0 meters (3.3 feet).
- D—Vertical distance to hazard zone. The hazard zone must be no lower than 2.5 meters/8.2 feet (US installations) or 2.0 meters/6.6 feet (global installations) above any surface upon which any persons are permitted to stand.  
If the vertical distance to hazard zone requirement (Zone D) is satisfied, the horizontal clearance distance (Zone C) is not needed.
- E—Represents the top view of the projector.
- F—Represents the side view of the projector.

For information detailing the hazard distance for each lens, refer to the product's *Installation and Setup guide*.

## For Installations in the United States

The following must be in place for laser-illuminated projector installations in the United States:

- The projection room shall be clearly identified by the posting of laser warning and restricted access signs, and by restricting entry through physical means. The projection room sign must display the warning "No direct exposure to beam shall be permitted".
- The Christie Laser Projection System Installation Checklist must be fully completed after the installation and sent to [lasercompliance@christiedigital.com](mailto:lasercompliance@christiedigital.com). A copy can remain on-site. This checklist can be found as a separate document in the accessory box with the manual.
- Certain US states have additional laser regulatory requirements. Contact [lasercompliance@christiedigital.com](mailto:lasercompliance@christiedigital.com) for additional regulatory requirements.

## CineMaster cinema calculator tool

The CineMaster cinema calculator tool helps you calculate and configure the optimal cinema set up. Use this tool to help determine the right projector, lens, and lamp based on the unique needs of your installation, as well as your preferred projector type, screen configuration, and brightness requirements.

<https://cinemaster.christiedigital.com/>

## Technical support

Technical support for Christie Cinema products is available at:

- [Support.cinema@christiedigital.com](mailto:Support.cinema@christiedigital.com)
- +1-877-334-4267
- Christie Professional Services: +1-800-550-3061 or [NOC@christiedigital.com](mailto:NOC@christiedigital.com)

## Contact your dealer

Record the information about your installation and keep this information with your records to assist with any servicing of your product. If you encounter a problem, contact your dealer.

Purchase record
Dealer:
Dealer or Christie Sales/Service contact phone number:
Serial number: The serial number can be found on the license label.
Purchase date:
Installation date:

# Operating the projector

Learn how to operate the projector and adjust projector settings.

## Projector power modes

The CineLife+ 2K projectors track laser operation hours for the light source.

The projector operates with the following power modes:

Mode	Description
Standby	<ul style="list-style-type: none"> <li>• CineLife+ 2K electronics remain on standby with the light engine off.</li> <li>• Fans, light source, and thermo-electric cooler (TEC) devices are off.</li> <li>• Integrated Media Block (IMB) is off—IMB automation does not function.</li> <li>• Fire alarm does not function.</li> </ul>
Standby (IMB On)	<ul style="list-style-type: none"> <li>• CineLife+ 2K electronics and the IMB are powered on with the light engine off.</li> <li>• Power is available to the optional touch panel and light source.</li> <li>• Power is available to the TEC devices; however, the drivers are disabled.</li> <li>• Some fans are low speed (depending on projector type).</li> <li>• Pumps are off.</li> </ul> <p>This mode is set from <b>Service Setup &gt; Preferences &gt; IMB</b>.</p>
Hibernate	<ul style="list-style-type: none"> <li>• Ethernet PHY for Wake On LAN (WOL) magic packet and Hibernate Interface switch powered and enabled.</li> <li>• Other parts of the projector are off.</li> </ul>
Projector on	<ul style="list-style-type: none"> <li>• CineLife+ 2K electronics and light engine are on.</li> <li>• Light source and TEC devices are off.</li> <li>• IMB is on.</li> </ul>
Light source on	<ul style="list-style-type: none"> <li>• CineLife+ 2K electronics and light engine are on.</li> <li>• Light source and TEC devices are on.</li> <li>• Fans run at full speed.</li> <li>• IMB is on.</li> </ul>

## Turning on or off the projector

Turn on the projector to display content or turn off the projector to conserve energy or service the projector.

In the right toolbar, select and hold **Power.** 

## LED status indicators

Red, yellow, green, and blue LEDs on the top rear of the projector indicate the status of the projector.

The following table provides the status indicator LED action and its meaning. The LEDs can be solidly lit, flash frequently, or flash intermittently.

LED action	Projector state	Description
Solid green	Power on	Power is on, light source is on.
Flashing green one time per second	Standby mode	Power is off, light source is off. Power saving mode.
Solid blue	Hibernate mode	Hibernate mode is on, power and light source are off. Power saving mode.
Flashing blue one time per second	Boot-up mode	Projector is booting up when waking up from Hibernate mode.
Flashing green three times per second	Warming up mode	Projector is warming up.
Flashing green and yellow	Cool-down mode	Power is on, light source is off. The light source can be turned on when in this mode.
Flashing yellow	Warning	Warning exists but has not been acknowledged by the operator.
Flashing red	New critical alarm or warning	New critical alarm or warning has not been acknowledged by the operator.
Solid red	Existing critical alarm or warning	Critical alarm or warning exists, but has been acknowledged by the operator.

## Logging into the projector

Log into the projector to access projector menus.

1. From the login page, in the User list, select a username.
2. Enter your password.
3. Select **Login.**

## Logging out of the projector

Log out of the projector to restrict access to projector menus or to change access permissions.

- Select **Logout**.

## Changing the session timeout

Session Timeout automatically logs a user out after a pre-determined duration of inactivity when using the Touch Panel Control or the Web User Interface (UI).

1. In the navigation menu, select **Service Setup**.
2. Select **Preferences**.
3. Select **General**.
4. In the System area, select Session Timeout duration:
  - 30 minutes—this is the default duration for Web UI.
  - 1 hour
  - 2 hours
  - 5 hours
  - 12 hours—this is only available for Web UI.
  - Never—this is only available for the Touch Panel Control and is the default.

## Determining the projector IP address

Before accessing the projector user interface remotely, determine the IP address of the projector. Use the following method to determine the projector IP address when no touch panel is installed.

1. Connect the projector to the theater network using an Ethernet cable.
2. Make sure the projector is not in Standby mode by selecting the raised button between the Hibernate port and the Management port on the Video Input panel.  
Pressing the raised button transitions the projector from Standby to Power on.



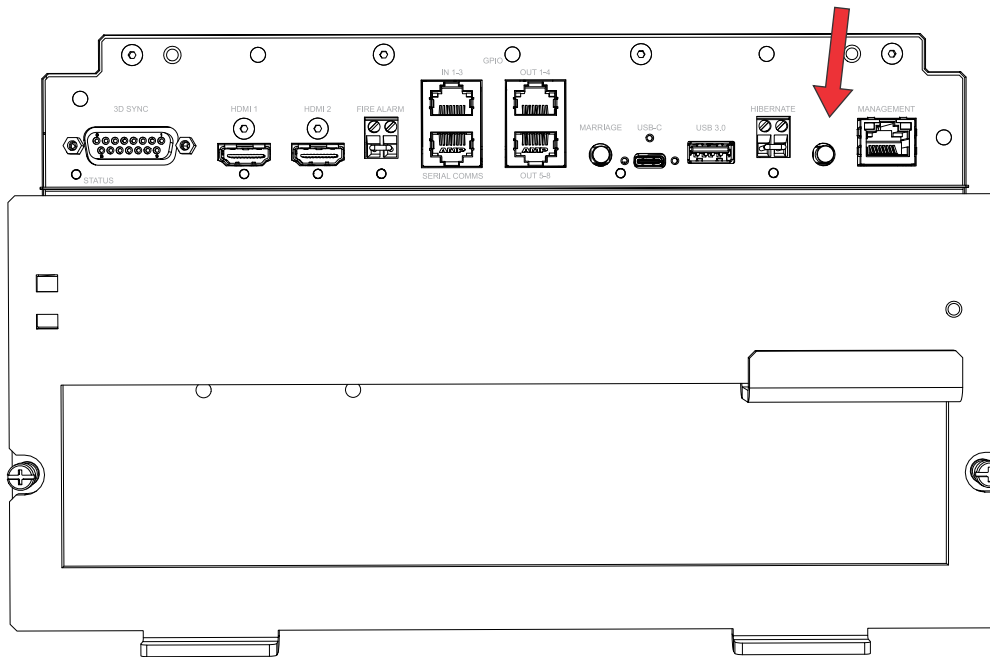

3. Make sure the path in front of the lens is clear and ready for the IP address to be projected as continuing to step 4 turns on the light source and projects the IP address on the screen.
4. Once the unit is powered on, select and hold the **Marriage** button on the projector for 5 to 25 seconds.  
The projector turns on the light source and displays a test pattern with the projector's IP address and any currently active alarms.  
The light source remains on.
5. To turn the light source off, select and hold the **Marriage** button for 5 to 25 seconds.

## Resetting the projector IP address to the default

Use the following method to reset the projector IP address to the default value (192.168.206.110) and the subnet is 255.255.255.0 when no touch panel is installed.

1. Connect the projector to the theater network using an Ethernet cable.
2. Make sure the projector is not in Standby mode by selecting the raised button between the Hibernate port and the Management port on the Video Input panel.  
Pressing the raised button transitions the projector from Standby to Power on.

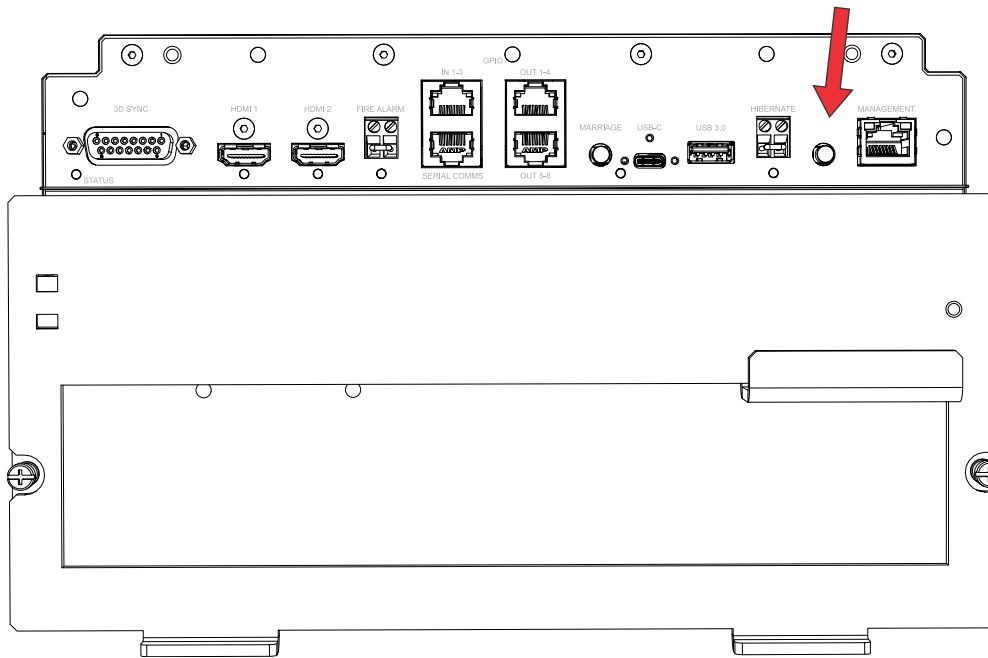

Before resetting the IP address to factory default, the light source turns on and remains on. The IP address is shown as described in *Determining the projector IP address* (on page 16).

3. Once the unit is powered on, select and hold the **Marriage** button on the projector for 30 seconds.  
The IP address of the projector is reset to the default.
4. Once you have reset the IP address, turn off the light source by selecting and holding the **Marriage** button for 5 to 25 seconds.

## Using the web user interface (Web UI)

Use a web browser to use the web UI to access projector functionality.

1. Log into the Web UI.  
The default IP address is 192.168.206.110.
2. To access the projector menu, select the left navigation menu.
3. To upload or download files from the projector, navigate to the feature.
4. If the projector has a GDC IMB SR-1000 installed and configured, access the GDC IMB Web UI by navigating to the left navigation menu and selecting **IMB**.

## Turning on or off the touch panel

Turn on the touch panel to view projector menus, or turn off the touch panel to conserve energy.

- To turn on or off the touch panel, select the **Power** button  (A) on the top of the touch panel.

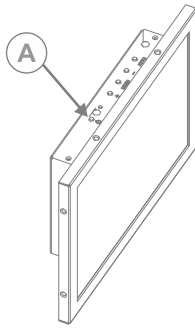

## Understanding the Christie touch panel interface and web user interface

Use the touch panel or web UI to control the projector and perform functions such as turning on or off the light, selecting channels, and viewing status information.



If no touch panel is installed, use the Web UI feature. See *Using the web user interface (Web UI)* (on page 18).

By default, the menu is not displayed. To access the menu, select the left navigation menu.

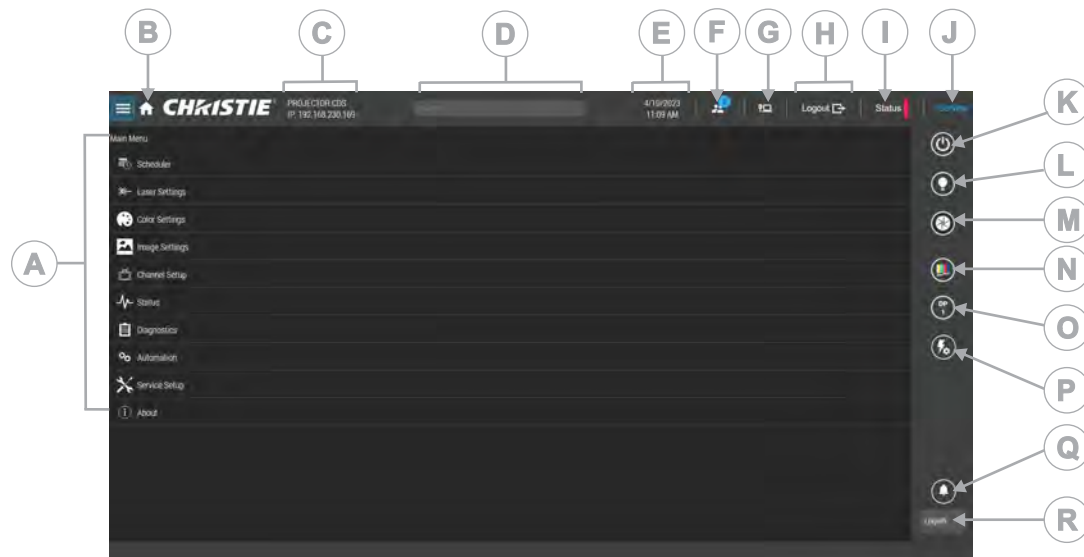

A	Left navigation menu Access permissions determine the available options.	J	Current access permissions
B	Dashboard Displays default dashboard. The dashboard displays Upcoming Events, Status, and Alarms (and Scheduler toggle).	K	Power Turns the projector on or off.
C	Projector name and IP address	L	Light Turns the light on or off.

D	Search bar	M	Douser Opens and closes the shutter.
E	Current date and time	N	Test Patterns Turns test patterns on or off.
F	Active users Displays how many users are logged into the projector.	O	All Channels Displays channels.
G	Network connection status	P	Macro Selection Displays automation macros.
H	Logout	Q	Notification history
I	System status To display all alarms, select the colored icon.	R	Language Displays current language preference.



## Turning on or off the light source

Turn on the light source to display content or view test patterns. Turn off the light to extend the life of the light source.

- To turn on or off the light source, in the right toolbar, select and hold **Light**. 
- If turning on the light source when the projector power is off, power is turned on automatically. Allow the projector to cool down for three minutes after turning it off.

## Opening or closing the shutter

Open the shutter (douser) to display light on the screen, or close the shutter to remove light from the screen.

- In the right toolbar, select and hold **Douser**. 
  - If the shutter was closed, the shutter opens. 
  - If the shutter was open, the shutter closes. 

The shutter sensor prevents light source activation when the shutter is closed.

- If the shutter is not functioning, use the **Permit light source activation when shutter is nonfunctional** option to permit activation of the light source. To enable this option, select **Service Setup > Preferences > Lens/ILS** and enable **Permit light source activation when shutter is nonfunctional**. To avoid damage to the projector, only enable this option when the shutter can be verified as open.

## Adding a network time protocol server

Add a network time protocol (NTP) server to synchronize the time on all installed projectors in the same region.

1. In the left navigation menu, select **Service Setup > Time Setup**.
2. Switch to the **Projector Time Settings** tab.
3. Select **Sync to NTP Server**.
4. Select **New NTP Server**.
5. In the Add New NTP Server dialog, select a local or a public NTP server:
  - To use a local NTP server, select **Local Server** and enter the IP address in the IP Address field.
  - To use a public NTP server, select **Public Server** and complete the Country and Server fields.
6. To test the connection, select **Test**.
7. Select **Add**.

## Deleting a network time protocol server

Remove a network time protocol (NTP) server if you do not need to synchronize the time on all installed projectors in the same region.

1. In the left navigation menu, select **Service Setup > Time Setup**.
2. Switch to the **Projector Time Settings** tab.
3. Select **Sync to NTP Server**.
4. In the NTP Server Address list, select an NTP server.
5. Select **Delete**. 
6. At the confirmation dialog, select **Delete**.

## Changing the time zone

Change the time zone settings to make the projector time match the local time zone.

1. In the left navigation menu, select **Service Setup > Time Setup**.
2. Select **Time Zone**.
3. In the Region list, select a region.
4. In the Time Zone list, select the time zone.
5. To automatically adjust the projector time to follow Daylight Saving Time, select **Automatically adjust for Daylight Saving Time**.  
The color of the slider changes to green to indicate it is active.
6. Select **Save**.

## Changing the time format



You can use the 12-hour or 24-hour format to display projector time. The 24-hour format reduces ambiguity.

1. In the left navigation menu, select **Service Setup > Preferences**.
2. Select **General**.
3. In the System area, select a time format option:
  - To use the 12-hour format, select **12 Hours**.
  - To use the 24-hour format, select **24 Hours**.

## Changing the orientation of the projected image

Change the orientation of the projected image from normal to inverted to support multi-projector installations where deflection mirrors are used.

1. In the left navigation menu, select **Service Setup > Preferences**.
2. Select **General**.
3. From the Projected Image Orientation list, select the required orientation for the projected image.

Orientation	Description
Normal Front	Projection from behind the audience with the projector in the normal, upright position.
Inverted Front	Projection from behind the audience with the projector in an inverted position (upside down).   Inverted positioning is not supported for CineLife+ 2K projectors. For more information, see the <i>Cinema 2K-RBe Installation and Setup Guide (P/N: 020-103907-XX)</i> .
Normal Rear	Projection from behind the screen with the projector in the normal, upright position.
Inverted Rear	Projection from behind the screen with the projector in an inverted position (upside down).   Inverted positioning is not supported for CineLife+ 2K projectors. For more information, see the <i>Cinema 2K-RBe Installation and Setup Guide (P/N: 020-103907-XX)</i> .

## Changing the projector hostname

Change the projector hostname to make it easier to identify.

1. In the left navigation menu, select **Service Setup > Preferences**.
2. Select **General**.
3. In the Projector Hostname field, enter a name.
4. Select **Update**.

The projector hostname is displayed above the IP address at the top of the screen.

## Changing the temperature display

Set the touch panel to display temperatures in Celsius or Fahrenheit degrees.

1. In the left navigation menu, select **Service Setup** > **Preferences**.
2. Select **General**.
3. In the Temperature Units list, select **Celsius** or **Fahrenheit**.

## Disabling serial authentication requirement

By default, Require Serial Authentication is turned on. If Require Serial Authentication is not required, you can manually disable this feature.

1. In the left navigation menu, select **Service Setup**.
2. Select **Preferences**.
3. Select **Automation**.
4. To disable serial authentication requirement, toggle off **Require Serial Authentication**.

## Viewing system status information

View alarms, warnings, and errors of the Christie CineLife+ 2K.

1. In the top right of the dashboard, select **Status**.  
You can also select **Status** from the left navigation menu.
2. Navigate to the status category you want to view and select it.

# Video Input panel

The Video Input panel, located on the projector side input panel (operator side), has a variety of ports that can supply alternative video content to the projector.

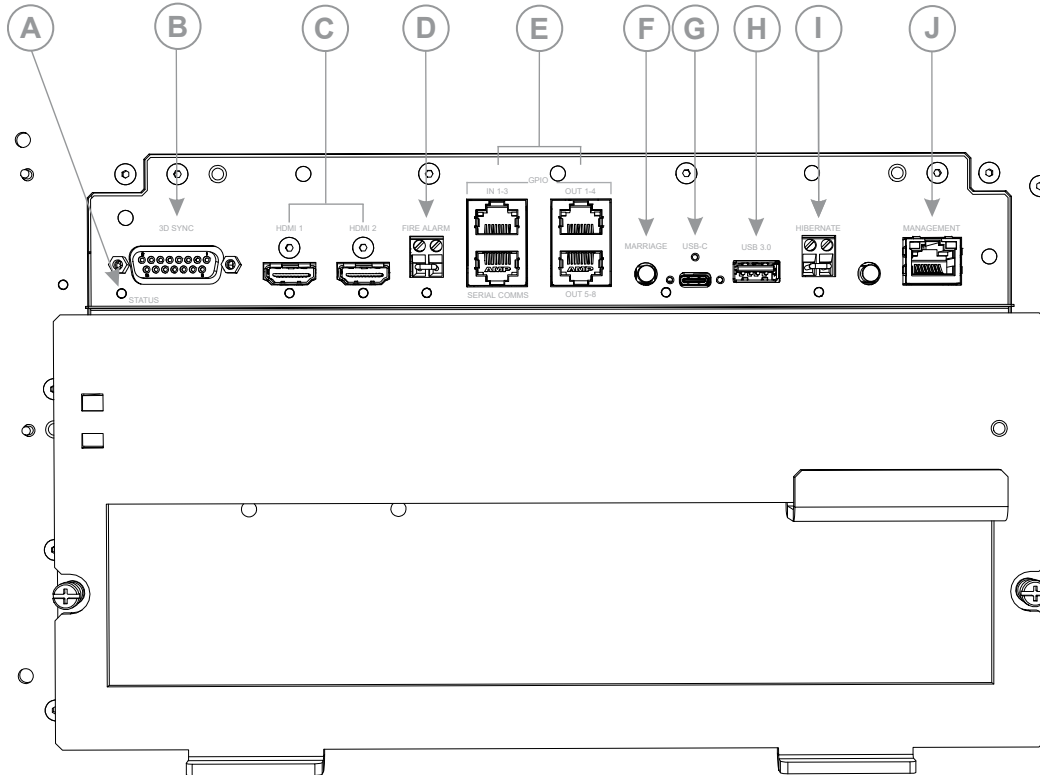

ID	Port	Description
A	Status	Provides a status indicator for the projector.
B	3D sync connector	Connects the projector to 3D devices.
C	HDMI input 1 and HDMI input 2	Type A connector Accepts digital video data from HDMI v2.0 input supporting EDID 1.3 with HDCP v1.4 and 2.2 support.
D	Fire alarm connection	Connects to the Theater Fire Management system for automatic shut down in emergency situations.
E	GPIO port	Connects the projector to external automation or automation devices.
F	Marriage button	Used during the Integrated Media Block (IMB) marriage setup process.



ID	Port	Description
		<ul style="list-style-type: none"> <li>Select and hold the button for 5 seconds to display the IP address and status information.</li> <li>Select and hold the button for 30 seconds to reset the IP address to the default address of 192.168.206.110.</li> </ul> <p>The marriage status LED indicator is located to the right of the Marriage button. In full power mode, a green LED indicates the projector is properly married and encrypted content can be displayed. A red LED indicates marriage is broken and encrypted content cannot be displayed.</p>
G	USB-C port	Connects the projector touch panel.
H	USB port	Connects to external memory device for import and export of projector software, configuration files, and status information.
I	Hibernate	Brings the projector out of Hibernate mode.
J	Management port	Connects to the local network and can send CineLife+ serial commands and used for Web UI access.

## HDMI video source

For the projector to accept digital video data from HDMI sources, plug the HDMI source directly into the Video Input panel.

The input configurations listed below are supported.

Input configuration	Description
Single-input	Accepts connection of one HDMI cable. Supports both 2D and 3D frame-packed, top and bottom. In this configuration, the HDMI input supplies the entire video raster.

## HDMI video formats

The following image formats are supported by the two HDMI inputs.



Fractional 1/1.001 frame rates, 1920 x 1080 (HD), and 3840 x 2160 (UHD) formats are also supported.

### Single-input 2D HD/2K and UHD/4K HDMI 2.0 image formats

Each HDMI input supports the following single-input (one cable) 2D HDMI 2.0 image formats.



4K image formats are downsampled to 2048x1080 in the projector video processing. 4K image formats at frame rates greater than 60Hz are not supported and the display performance is undefined.

	Format	Cables	Frame rate (Hz)	Sampling	Bit-depth
HD	1920x1080	1	24, 25, 30, 50, 60, 120	Y'C <sub>B</sub> C <sub>R</sub> /RGB/4:4:4 Y'C <sub>B</sub> C <sub>R</sub> /4:2:2	8/10/12 bpc

	Format	Cables	Frame rate (Hz)	Sampling	Bit-depth
	2048x1080	1	24, 25, 30, 50, 60, 120	Y'C <sub>B</sub> C <sub>R</sub> /RGB/4:4:4 Y'C <sub>B</sub> C <sub>R</sub> /4:2:2	8/10/12 bpc
4K	3840x2160	1	24, 25, 30	Y'C <sub>B</sub> C <sub>R</sub> /RGB/4:4:4	8/10 bpc
	3840x2160	1	24, 25, 30	Y'C <sub>B</sub> C <sub>R</sub> /4:2:2	8/10/12 bpc
	3840x2160	1	50, 60	Y'C <sub>B</sub> C <sub>R</sub> /RGB/4:4:4	8 bpc
	3840x2160	1	50, 60	Y'C <sub>B</sub> C <sub>R</sub> /4:2:2	8/10/12 bpc
	4096x2160	1	24, 25, 30	Y'C <sub>B</sub> C <sub>R</sub> /RGB/4:4:4	8/10 bpc
	4096x2160	1	24, 25, 30	Y'C <sub>B</sub> C <sub>R</sub> /4:2:2	8/10/12 bpc
	4096x2160	1	50, 60	Y'C <sub>B</sub> C <sub>R</sub> /RGB/4:4:4	8 bpc
	4096x2160	1	50, 60	Y'C <sub>B</sub> C <sub>R</sub> /4:2:2	8/10/12 bpc

### Single-input 2D HD HDMI 2.0 image formats

Each HDMI input supports the following single-input (one cable) 2D HD HDMI 2.0 image formats.

	Format	Cables	Frame rate (Hz)	Sampling	Bit-depth	Notes
HD	1280x720	1	24, 25, 30, 50, 60	Y'C <sub>B</sub> C <sub>R</sub> /RGB/4:4:4 Y'C <sub>B</sub> C <sub>R</sub> /4:2:2	8/10/12 bpc	—
	1920x1080i	1	25, 30	Y'C <sub>B</sub> C <sub>R</sub> /RGB/4:4:4 Y'C <sub>B</sub> C <sub>R</sub> /4:2:2	8/10/12 bpc	1920x1080 interlaced (50/60 Hz field rate)

### Single-input 3D 2K/HD HDMI 2.0 image formats

Each HDMI input supports the following single-input (one cable) 3D 2K/HD HDMI 2.0 image formats.

	Format	Cables	Frame rate (Hz)	Sampling	Bit-depth	Notes
3D	1280x720	1	50, 60	Y'C <sub>B</sub> C <sub>R</sub> /RGB/4:4:4 Y'C <sub>B</sub> C <sub>R</sub> /4:2:2	8/10/12 bpc	Frame-packing/top-and-bottom
	1920x1080	1	24, 25, 30, 50, 60	Y'C <sub>B</sub> C <sub>R</sub> /RGB/4:4:4 Y'C <sub>B</sub> C <sub>R</sub> /4:2:2	8/10/12 bpc	Frame-packing

## Integrated Media Block (IMB) video source

Christie Series 4 projectors support both the legacy Series 2 (S2) and newer Series 4 (S4) HDRConnect™ IMB interfaces to send digital video data from an IMB to the projector.

Contact Christie Technical Support to learn which S2 and S4 IMB devices are compatible with Christie projectors.

## Series 2 Integrated Media Block (IMB) video formats

S2 Integrated Media Block (IMB) video format support is determined by the IMB make and model. Refer to the associated IMB documentation to understand which of the following video signals are supported.

All MPEG-2 content is converted in the media block to RGB 4:4:4 8-bit before play out.

### MPEG image formats

Format	Resolution	Max frame rate 2D	Max frame rate 3D	Min frame rate	Bit-depth
VGA	640x480	120.0	120.0	23.0	8-bits
4CIF	704x576	120.0	120.0	23.0	8-bits
525 SD	720x480	120.0	120.0	23.0	8-bits
625 SD	720x568	120.0	120.0	23.0	8-bits
XGA	1024x768	79.6	79.6	23.0	8-bits
720p HD	1280x720	68.0	68.0	23.0	8-bits
4VGA	1280x960	51.0	51.0	23.0	8-bits
SXGA	1280x1024	47.8	N/A	23.0	8-bits
525 16SIF	1408x960	46.3	N/A	23.0	8-bits
16CIF	1408x1152	38.6	N/A	23.0	8-bits
4SVGA	1600x1200	32.6	N/A	23.0	8-bits
1080 HD	2048x1080	30.0	N/A	23.0	8-bits

### MPEG-2 MXF interop 2D image formats

Format	Resolution	Max frame rate 2D	Max frame rate 3D	Min frame rate	Bit-depth
VGA	640x480	120.0	120.0	23.0	8-bits
525 4SIF	704x480	120.0	120.0	23.0	8-bits
525 SD	720x480	120.0	120.0	23.0	8-bits
4CIF	704x576	120.0	120.0	23.0	8-bits
625 SD	800x600	120.0	120.0	23.0	8-bits
SVGA	1024x768	79.6	79.6	23.0	8-bits
XGA	1024x768	79.6	79.6	23.0	8-bits
720p HD	1280x720	68.0	68.0	23.0	8-bits
4VGA	1280x960	51.0	51.0	23.0	8-bits
SXGA	1280x1024	47.8	N/A	23.0	8-bits
525 16SIF	1408x960	46.3	N/A	23.0	8-bits

Format	Resolution	Max frame rate 2D	Max frame rate 3D	Min frame rate	Bit-depth
16CIF	1408x1152	38.6	N/A	23.0	8-bits
4SVGA	1600x1200	32.6	N/A	23.0	8-bits
1080 HD	2048x1080	30.0	N/A	23.0	8-bits

### SMPTTE-compatible 2D (JPEG 2000) cinema image formats



4K image formats are downscaled to 2048x1080 in the projector video processing. 4K image formats at frame rates greater than 30Hz are not supported and the output image is undefined.

Specification	Resolution	Frame rate	Color format	Bit-depth
SMPTE 428-1-2006	2048x1080	24.0	X'Y'Z' (4:4:4)	12-bits
SMPTE 428-11-2009	2048x1080	25.0	X'Y'Z' (4:4:4)	12-bits
SMPTE 428-11-2009	2048x1080	30.0	X'Y'Z' (4:4:4)	12-bits
SMPTE 428-1-2009	2048x1080	48.0	X'Y'Z' (4:4:4)	12-bits
SMPTE 428-11-2009	2048x1080	50.0	X'Y'Z' (4:4:4)	12-bits
SMPTE 428-11-2009	2048x1080	60.0	X'Y'Z' (4:4:4)	12-bits
SMPTE 428-11-2009	2048x1080	96.0	X'Y'Z' (4:4:4)	12-bits
SMPTE 428-11-2009	2048x1080	100.0	X'Y'Z' (4:4:4)	12-bits
SMPTE 428-11-2009	2048x1080	120.0	X'Y'Z' (4:4:4)	12-bits
SMPTE 428-1-2006	4096x2160	24.0	X'Y'Z' (4:4:4)	12-bits
SMPTE 428-11-2009	4096x2160	25.0	X'Y'Z' (4:4:4)	12-bits
SMPTE 428-11-2009	4096x2160	30.0	X'Y'Z' (4:4:4)	12-bits
SMPTE 2048-1-2011	4096x2160	48.0	X'Y'Z' (4:4:4)	12-bits
SMPTE 2048-1-2011	4096x2160	50.0	X'Y'Z' (4:4:4)	12-bits
SMPTE 2048-1-2011	4096x2160	60.0	X'Y'Z' (4:4:4)	12-bits

### SMPTTE-compatible single 3D (JPEG 2000) cinema image formats



4K image formats are downscaled to 2048X1080 in the projector video processing. 4K image formats at frame rates greater than 30Hz per eye are not supported and the output image is undefined.

Specification	Resolution	Frame rate (per eye)	Color format	Bit-depth
SMPTE 428-1-2006	2048x1080	24.0	X'Y'Z' (4:4:4)	12-bits
SMPTE 428-11-2009	2048x1080	25.0	X'Y'Z' (4:4:4)	12-bits
SMPTE 428-11-2009	2048x1080	30.0	X'Y'Z' (4:4:4)	12-bits
SMPTE 428-11-2009	2048x1080	48.0	X'Y'Z' (4:4:4)	12-bits

Specification	Resolution	Frame rate (per eye)	Color format	Bit-depth
SMPTE 428-11-2009	2048x1080	50.0	X'Y'Z' (4:4:4)	12-bits
SMPTE 428-11-2009	2048x1080	60.0	X'Y'Z' (4:4:4)	12-bits
SMPTE 428-1-2006	4096x2160	24.0	X'Y'Z' (4:4:4)	12-bits
SMPTE 428-11-2009	4096x2160	25.0	X'Y'Z' (4:4:4)	12-bits
SMPTE 428-11-2009	4096x2160	30.0	X'Y'Z' (4:4:4)	12-bits

### SMPTE-compatible dual 3D (JPEG 2000) cinema image formats



4K image formats are downscaled to 2048x1080 in the projector video processing.

Specification	Resolution	Frame rate	Color format	Bit-depth
SMPTE 428-1-2006	2048x1080	24.0	X'Y'Z' (4:4:4)	12-bits
SMPTE 428-11-2009	2048x1080	25.0	X'Y'Z' (4:4:4)	12-bits
SMPTE 428-11-2009	2048x1080	30.0	X'Y'Z' (4:4:4)	12-bits
SMPTE 428-11-2009	2048x1080	48.0	X'Y'Z' (4:4:4)	12-bits
SMPTE 428-11-2009	2048x1080	50.0	X'Y'Z' (4:4:4)	12-bits
SMPTE 428-11-2009	2048x1080	60.0	X'Y'Z' (4:4:4)	12-bits
SMPTE 428-11-2009	2048x1080	96.0	X'Y'Z' (4:4:4)	12-bits
SMPTE 428-11-2009	2048x1080	100.0	X'Y'Z' (4:4:4)	12-bits
SMPTE 428-11-2009	2048x1080	120.0	X'Y'Z' (4:4:4)	12-bits
SMPTE 428-1-2006	4096x2160	24.0	X'Y'Z' (4:4:4)	12-bits
SMPTE 428-11-2009	4096x2160	25.0	X'Y'Z' (4:4:4)	12-bits
SMPTE 428-11-2009	4096x2160	30.0	X'Y'Z' (4:4:4)	12-bits
SMPTE 2048-1-2011	4096x2160	48.0	X'Y'Z' (4:4:4)	12-bits
SMPTE 2048-1-2011	4096x2160	50.0	X'Y'Z' (4:4:4)	12-bits
SMPTE 2048-1-2011	4096x2160	60.0	X'Y'Z' (4:4:4)	12-bits

### Series 4 Integrated Media Block (IMB) video formats

S4 Integrated Media Block (IMB) video format support is determined by the IMB make and model. Refer to the associated IMB documentation to understand which of the following video signals are supported.

All MPEG-2 content is converted in the media block to RGB 4:4:4 8-bit before play out.

**MPEG image formats**

Format	Resolution	Max frame rate 2D	Max frame rate 3D	Min frame rate	Bit depth
VGA	640x480	120.0	120.0	23.0	8-bits
525 4SIF	704x480	120.0	120.0	23.0	8-bits
525 SD	720x480	120.0	120.0	23.0	8-bits
4CIF	704x576	120.0	120.0	23.0	8-bits
625 SD	800x600	120.0	120.0	23.0	8-bits
SVGA	1024x768	79.6	79.6	23.0	8-bits
XGA	1024x768	79.6	79.6	23.0	8-bits
720p HD	1280x720	68.0	68.0	23.0	8-bits
4VGA	1280x960	51.0	51.0	23.0	8-bits
SXGA	1280x1024	47.8	N/A	23.0	8-bits
525 16SIF	1408x960	46.3	N/A	23.0	8-bits
16CIF	1408x1152	38.6	N/A	23.0	8-bits
4SVGA	1600x1200	32.6	N/A	23.0	8-bits
1080 HD	2048x1080	30.0	N/A	23.0	8-bits

**MPEG-2 MXF interop 2D image formats**

Format	Resolution	Max frame rate 2D	Max frame rate 3D	Min frame rate	Bit depth
VGA	640x480	120.0	120.0	23.0	8-bits
525 4SIF	704x480	120.0	120.0	23.0	8-bits
525 SD	720x480	120.0	120.0	23.0	8-bits
625 SD	720x568	120.0	120.0	23.0	8-bits
4CIF	704x576	120.0	120.0	23.0	8-bits
XGA	1024x768	79.6	79.6	23.0	8-bits
720p HD	1280x720	68.0	68.0	23.0	8-bits
4VGA	1280x960	51.0	51.0	23.0	8-bits
SXGA	1280x1024	47.8	N/A	23.0	8-bits
525 16SIF	1408x960	46.3	N/A	23.0	8-bits
16CIF	1408x1152	38.6	N/A	23.0	8-bits
4SVGA	1600x1200	32.6	N/A	23.0	8-bits
1080 HD	2048x1080	30.0	N/A	23.0	8-bits

### SMPTE-compatible 2D (JPEG 2000) cinema image formats



4K image formats are downscaled to 2048x1080 in the projector video processing.

Specification	Resolution	Frame rate	Color format	Bit depth	Notes
SMPTE 428-1-2006	2048x1080	24.0	X'Y'Z' (4:4:4)	12-bits	—
SMPTE 428-11-2009	2048x1080	25.0	X'Y'Z' (4:4:4)	12-bits	—
SMPTE 428-11-2009	2048x1080	30.0	X'Y'Z' (4:4:4)	12-bits	—
SMPTE 428-1-2009	2048x1080	48.0	X'Y'Z' (4:4:4)	12-bits	—
SMPTE 428-11-2009	2048x1080	50.0	X'Y'Z' (4:4:4)	12-bits	—
SMPTE 428-11-2009	2048x1080	60.0	X'Y'Z' (4:4:4)	12-bits	—
SMPTE 428-11-2009	2048x1080	96.0	X'Y'Z' (4:4:4)	12-bits	—
SMPTE 428-11-2009	2048x1080	100.0	X'Y'Z' (4:4:4)	12-bits	—
SMPTE 428-11-2009	2048x1080	120.0	X'Y'Z' (4:4:4)	12-bits	—
SMPTE 428-1-2006	4096x2160	24.0	X'Y'Z' (4:4:4)	12-bits	—
SMPTE 428-11-2009	4096x2160	25.0	X'Y'Z' (4:4:4)	12-bits	—
SMPTE 428-11-2009	4096x2160	30.0	X'Y'Z' (4:4:4)	12-bits	—
SMPTE 2048-1-2011	4096x2160	48.0	X'Y'Z' (4:4:4)	12-bits	—
SMPTE 2048-1-2011	4096x2160	50.0	X'Y'Z' (4:4:4)	12-bits	Requires 96 Hz video license in IMB-S4
SMPTE 2048-1-2011	4096x2160	60.0	X'Y'Z' (4:4:4)	12-bits	Requires 96 Hz video license in IMB-S4

### SMPTE-compatible single 3D (JPEG 2000) cinema image formats



4K image formats are downscaled to 2048X1080 in the projector video processing. 4K image formats at frame rates greater than 30Hz per eye are not supported and the output image is undefined.

Specification	Resolution	Frame rate (per eye)	Color format	Bit depth	Notes
SMPTE 428-1-2006	2048x1080	24.0	X'Y'Z' (4:4:4)	12-bits	—
SMPTE 428-11-2009	2048x1080	25.0	X'Y'Z' (4:4:4)	12-bits	—
SMPTE 428-11-2009	2048x1080	30.0	X'Y'Z' (4:4:4)	12-bits	—
SMPTE 428-11-2009	2048x1080	48.0	X'Y'Z' (4:4:4)	12-bits	—
SMPTE 428-11-2009	2048x1080	50.0	X'Y'Z' (4:4:4)	12-bits	—
SMPTE 428-11-2009	2048x1080	60.0	X'Y'Z' (4:4:4)	12-bits	—
SMPTE 428-1-2006	4096x2160	24.0	X'Y'Z' (4:4:4)	12-bits	—
SMPTE 428-11-2009	4096x2160	25.0	X'Y'Z' (4:4:4)	12-bits	Requires 96 Hz video license in IMB-S4
SMPTE 428-11-2009	4096x2160	30.0	X'Y'Z' (4:4:4)	12-bits	Requires 96 Hz video license in IMB-S4

### SMPTE-compatible dual 3D (JPEG 2000) cinema image formats



4K image formats are downscaled to 2048X1080 in the projector video processing.

Specification	Resolution	Frame rate (per eye)	Color format	Bit depth	Notes
SMPTE 428-1-2006	2048x1080	24.0	X'Y'Z' (4:4:4)	12-bits	—
SMPTE 428-11-2009	2048x1080	25.0	X'Y'Z' (4:4:4)	12-bits	—
SMPTE 428-11-2009	2048x1080	30.0	X'Y'Z' (4:4:4)	12-bits	—
SMPTE 428-11-2009	2048x1080	48.0	X'Y'Z' (4:4:4)	12-bits	—
SMPTE 428-11-2009	2048x1080	50.0	X'Y'Z' (4:4:4)	12-bits	—
SMPTE 428-11-2009	2048x1080	60.0	X'Y'Z' (4:4:4)	12-bits	—
SMPTE 428-11-2009	2048x1080	96.0	X'Y'Z' (4:4:4)	12-bits	—



Specification	Resolution	Frame rate (per eye)	Color format	Bit depth	Notes
SMPTE 428-11-2009	2048x1080	100.0	X'Y'Z' (4:4:4)	12-bits	—
SMPTE 428-11-2009	2048x1080	120.0	X'Y'Z' (4:4:4)	12-bits	—
SMPTE 428-1-2006	4096x2160	24.0	X'Y'Z' (4:4:4)	12-bits	—
SMPTE 428-11-2009	4096x2160	25.0	X'Y'Z' (4:4:4)	12-bits	—
SMPTE 428-11-2009	4096x2160	30.0	X'Y'Z' (4:4:4)	12-bits	—
SMPTE 2048-1-2011	4096x2160	48.0	X'Y'Z' (4:4:4)	12-bits	—
SMPTE 2048-1-2011	4096x2160	50.0	X'Y'Z' (4:4:4)	12-bits	Requires 96 Hz video license in IMB-S4
SMPTE 2048-1-2011	4096x2160	60.0	X'Y'Z' (4:4:4)	12-bits	Requires 96 Hz video license in IMB-S4

## HDMI video source connection from an Integrated Media Block (IMB)

The projector can accept digital video data from HDMI sources connected to applicable Integrated Media Block (IMB) devices. The input configurations supported are determined by the IMB device directly.

Contact Christie Technical Support to learn which IMB devices provide HDMI source selection from the projector user interface.

HDMI input selection directly from the IMB may also be possible using the IMB user interface. The input configurations supported are determined by the IMB make and model.

## SDI video source connection from an Integrated Media Block (IMB)

The projector can accept digital video data from SDI sources connected to applicable Integrated Media Block (IMB) devices.

The input configurations supported are determined by the IMB device directly. Contact Christie Technical Support to learn which IMB devices provide SDI source selection from the projector user interface.

SDI input selection directly from the IMB may also be possible using the IMB user interface. The input configurations supported are determined by the IMB make and model.

## GPIO connector

The Generic Purpose Input Output (GPIO) connectors provide a flexible method of interfacing with the projector. There are three GPIO connectors with one connector reserved for serial communications.

The GPIO connectors are located on the input panel (*E in the Video Input panel image (on page 24)*).

### Left-side GPI pins

The top six GPI pins are available for inputs with the other two pins reserved for ground and power. The bottom pins are reserved for serial communications.

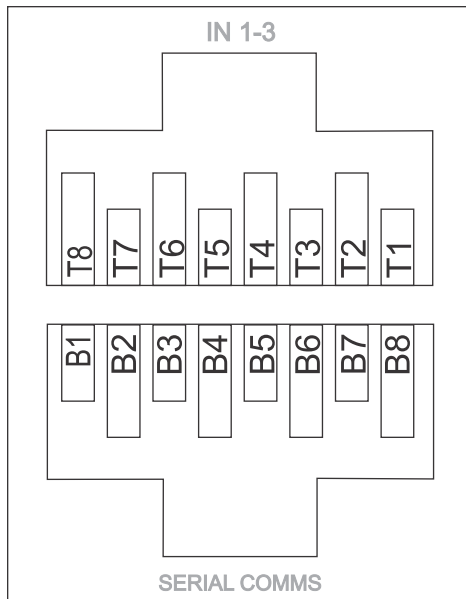

Pin number	Signal name	Direction
T1	+5V	—
T2	GND	—
T3	GPI1_POS	In
T4	GPI1_NEG	In
T5	GPI2_POS	In
T6	GPI2_NEG	In
T7	GPI3_POS	In
T8	GPI3_NEG	In
B1 to B8	Serial Communications Reserved for future use.	—

### Right-side GPO pins

The 16 pins are available for output.

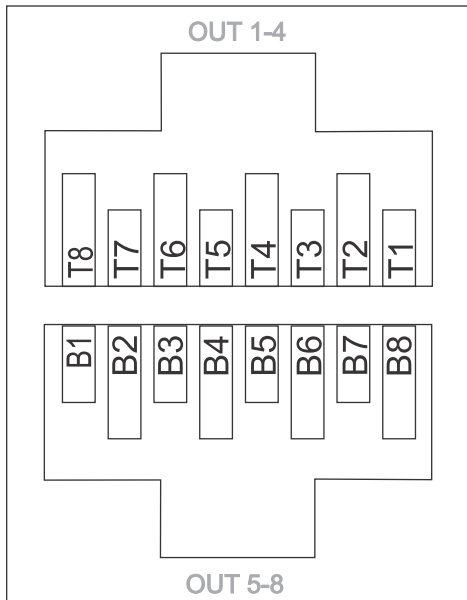

Pin number	Signal name	Direction
T1	GPO1_SRC	Out
T2	GPO1_RTN	Out
T3	GPO2_SRC	Out
T4	GPO2_RTN	Out
T5	GPO3_SRC	Out
T6	GPO3_RTN	Out
T7	GPO4_SRC	Out
T8	GPO4_RTN	Out
B1	GPO5_SRC	Out
B2	GPO5_RTN	Out
B3	GPO6_SRC	Out
B4	GPO6_RTN	Out
B5	GPO7_SRC	Out
B6	GPO7_RTN	Out
B7	Health_SRC	Out
B8	Health_RTN	Out

### GPIO inputs

The 5 VDC (pin T1 and pin T2 in the left-hand GPI) is intended for use to supply the inputs.

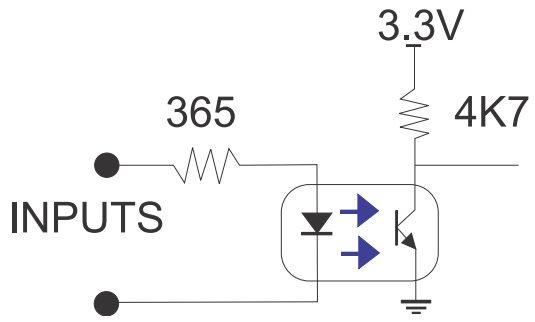

**GPIO outputs**

Outputs are solid state relays with a 1 A AC/DC rating at up to 48 V.

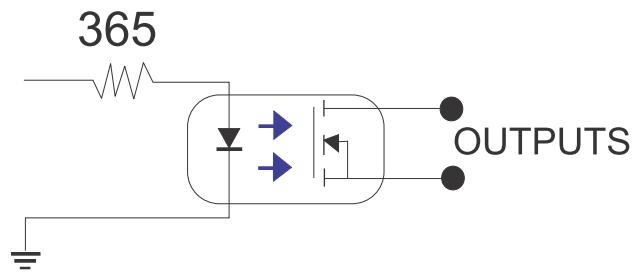

# Hibernate mode

Hibernate mode achieves extremely low standby power with restricted operational capability. Hibernate mode is disabled by default and only available through serial or Ethernet commands.

## Enabling hibernate mode

Enable hibernate mode through the projector Ethernet port to allow for restricted standby power.

When hibernate mode is enabled, the touch panel control and web user interface are unavailable. For more information, see the *CineLife+ Serial Commands Guide (P/N: 020-103075-XX)*.

1. To connect to the projector Ethernet port, change the IP address of your computer to place your computer on the same subnet as the projector.
2. Connect to the projector using port 5000 from your computer.  
Use a Telnet client, such as Net-Terminal, Kore Librarian, or PuTTY, to connect to the projector.
3. Log in as operator:  
(UID "operator" "operator")
4. Send the following serial command:  
(PWR -2)

A blue light appears underneath the Hibernate port when hibernate mode is on.

## Waking up from hibernate mode

Learn how to wake up the projector from hibernate mode.

Once the projector wakes up from hibernate mode, it goes into standby mode or a pre-configured mode for initial power-on. To wake up from hibernate mode, choose one of the following methods.

Option	Steps
Raised button	<ol style="list-style-type: none"> <li>1. Access the Video Input panel on the electronics side of the projector.</li> <li>2. Press the raised button located between the Hibernate port and the Management port.</li> </ol>
Hibernate port	<ol style="list-style-type: none"> <li>1. Access the Video Input panel on the electronics side of the projector.</li> <li>2. Connect a relay or automation device to the Hibernate port.</li> </ol>
Wake-on-LAN (WoL) Magic Packet program This option requires the IP address and MAC address of your projector.	<ol style="list-style-type: none"> <li>1. Make sure the projector is on a local subnet.</li> <li>2. Open a WoL program.</li> <li>3. Follow the prompts.</li> </ol>

<b>Option</b>	<b>Steps</b>
AC power breaker switch	<ol style="list-style-type: none"> <li>1. Access the rear of the projector.</li> <li>2. Move the MAIN breaker switch to the OFF position.</li> <li>3. Move the MAIN breaker switch to the ON position.</li> </ol>

# Managing the light source

Learn how to configure a laser file and use the projector's LiteLOC™ feature.

Use the laser file to control the power settings of the lasers. The LiteLOC™ feature ensures that color and brightness are held at the level you set.

Create multiple laser files to manage varying screen sizes, brightness requirements, and types of content (such as 2D, 3D, and alternative content).

## Creating a new laser file

Create a laser file to store the power settings for the laser light source.

If you make significant change to the brightness level when refining the laser power settings, it takes a few minutes for the color and brightness to stabilize.

1. Log in as service.
2. Turn on the laser.
3. *Set a channel to use the appropriate calibration file (on page 53) and activate the channel (on page 55).*
4. Display a test pattern, such as DC2K 17 L Point, to locate the center of the screen.
5. Set up the color meter to aim at the center of the screen.
6. In the left navigation menu, select **Laser Settings** > **Laser Power/LiteLOC Setup**.
7. Select **Display White Test Pattern**.
8. To create a new laser file, select **Create**. 
9. In the Create dialog, enter a name for the new laser file and select **Create**.
10. In the White Coordinates dialog, set the required white point.  
For a typical cinema setup, the white point is Digital Cinema Initiative (DCI) white  $x=0.314$  and  $y=0.351$ .
11. Select **Apply**.
12. Adjust the brightness level until you achieve the required brightness at the specified white point.
13. If the laser file will be associated with a 3D channel, complete the following steps:
  - a) Engage the 3D system in the light path by enabling **3D Sync** when selecting the test pattern.
  - b) Mount a 3D glass or filter on the color meter to measure the brightness.
  - c) Select **3D Sync** on the LiteLOC™ setup page.

- d) Adjust the brightness level until you achieve the required brightness while the 3D system is engaged.

14. To save the new laser file, select **Save**. 

## Modifying an existing laser file

Modify the settings in the laser file to change the laser power settings.

If you make significant change to the brightness level when refining the laser power settings, it takes a few minutes for the color and brightness to stabilize.

1. Log in as service.
2. Turn on the laser.
3. Display a test pattern, such as DC4K 17 L Point or DC2K 17 L Point, to locate the center of the screen.
4. In the left navigation menu, select **Laser Settings > Laser Power/LiteLOC Setup**.
5. To begin modifying the settings, select **Display White Test Pattern**.
6. From the Laser File list, select the laser file to edit.
7. In the White Coordinates dialog, set the required white point.  
For a typical cinema setup, the white point is DCI white  $x=0.314$  and  $y=0.351$ .
8. Select **Apply**.
9. Set the brightness levels as required for your projection environment and allow the projector to stabilize for a few minutes.  
System stability may be affected if you set a power level below the minimum power level recommended.
10. If white or brightness is not at the target level, adjust the settings to achieve the target and allow the projector to re-stabilize for an additional three to five minutes.



The projector is considered stable when no further adjustments are required and you obtain the same screen state results after two sets of measurements, five minutes apart.

11. To save the new settings, select **Save**. 

## Copying existing laser settings to a new file

Copy an existing laser file when creating a new file with similar settings.

1. In the left navigation menu, select **Laser Settings > Laser Power/LiteLOC Setup**.
2. From the Laser File list, select the file to copy.
3. To save the new laser file, select **Save As**. 
4. Enter a new name for the laser file and then select **Save**.
5. Adjust the settings as required for the new configuration.
6. Select **Save**.



## Deleting a laser file

Delete a laser file when the configuration is no longer required.

1. In the left navigation menu, select **Laser Settings > Laser Power/LiteLOC Setup**.
2. In the Laser File list, select the file to delete.
3. Select **Delete**. 
4. To confirm the deletion, select **Delete**.

## LiteLOC™ sensor-to-screen calibration

The LiteLOC™ sensor-to-screen calibration is performed in the factory under specific setup conditions which include the type of lens, screen, and the spectroradiometer used for measuring screen color and brightness.

Your projector's setup conditions may not match the factory setup which may result in a discrepancy in color accuracy. Upon first installation, check the accuracy of the color point and if unsatisfactory, perform this calibration. Doing this calibration captures all the variables of your setup and achieves the best results. By doing this calibration, you do not overwrite the factory calibration. Once satisfied, some scenarios may exist in which you may need to re-do the calibration in the future.

Re-doing this calibration is required if the following is replaced:

- Color sensor board

Christie recommends re-doing this calibration if any of the following are replaced:

- Light engine
- Lens
- Light source
- Screen
- Port window
- Any other optical components in the optical path between the light source and the screen

After replacing these components, check the accuracy of the color point and if unsatisfactory, re-do this calibration.

## LiteLOC™ sensor-to-screen calibration: Workflow

Identify the recommended order for performing the sensor-to-screen calibration.



LiteLOC™ sensor-to-screen calibration requires the following:

- Spectroradiometer
- Service user is the minimum level user access
- *Create a new calibration file* (on page 42).
- Recalibrate the calibration file, if required.
- *Edit the existing calibration file parameters* (on page 44) on the Sensor-to-screen menu, if required.

- *Verify the calibration* (on page 44), if required.
- *Add the calibration file to the Channel Setup* (on page 45).

## Creating a new calibration file

The Sensor-to-screen Calibration wizard guides you through the steps required to create a new calibration file.

1. Set up a spectroradiometer to obtain screen measurements later in the process.
2. In the left navigation menu, select **Color Settings > Sensor-to-screen Calibration**.
3. To create a new calibration file, select **Create** .

The projector checks if the light source is on and the douser is open. If either condition is not met, a warning dialog is displayed prompting you to make sure these conditions are met before starting the wizard.

4. In the Create dialog, enter a name for the new calibration file and select **Create**.
5. In step 1 of the Sensor-to-screen Calibration wizard, set the maximum brightness and color point.
  - a) Enable the **Display White Test Pattern** option.
  - b) Adjust the RGB sliders to set the brightness and color point.
  - c) Select **Next**.

6. Wait 20 minutes for the projector to stabilize or select **Skip** during the stabilization time period.

7. In step 2 of the Sensor-to-screen Calibration wizard, measure and enter the screen values.
  - a) To trigger the measurement at a specific operating point, under Sensor to screen, select **Capture**.

The Capture button changes color to indicate the capture process is activated. Only one Capture button is active at a time but the buttons can be selected in any order.

The projector automatically sets the red, green, and blue output laser powers to the pre-determined settings calculated and displayed in the Drive Percentage (Calculated) area of the wizard.

A 10 second countdown begins to allow the projector white point and brightness to stabilize and no changes can be made. At the end of the countdown period, the Color Sensor values fields are automatically populated by the projector for the currently selected drive percentage value.

- b) When the countdown ends, take x, y, and fL measurements using the spectroradiometer. Christie recommends taking meter readings from the center of the screen to obtain accurate screen measurements.

- c) Under Measured Values, using the numeric keypad record the associated spectroradiometer values for x, y, and fL.

The projector holds the on-screen color and brightness level until the same or another Capture button is selected.

- d) Repeat steps a to c for the remaining drive percentage set points until all x, y, and fL values are entered.

Spectroradiometer measurements can be captured in any order but all three x, y, and fL measurements must be entered before moving onto the next capture. You can recapture a specific measurement at any time during the process by selecting the Capture button. In this case, the measured spectroradiometer and color sensor values are reset.

- e) Once all the color sensor and measured values are entered for all rows, select **Apply and Save**.
8. Verify and complete the calibration.
  - a) Select a white point to measure by selecting either the **DCI**, **D65**, or **Custom** white point buttons.

Once selected, the projector automatically enables LiteLOC™, selects a White test pattern with uncorrected colors at the white point specified, and sets the brightness to 80%.
  - b) Using a spectroradiometer, measure screen x and y values at the center of the screen.

To verify the calibration has been successfully applied, the measured white point must be within the expected tolerance.
  - c) When complete, select **Finish**.

The projector output is configured according to the currently selected calibration file and you are returned to the Sensor-to-screen Calibration menu.

## Recalibrating an existing calibration file

The Sensor-to-screen Calibration wizard guides you through the steps required to re-calibrate an existing calibration file, if required.

1. Select **Menu > Color Settings > Sensor-to-screen Calibration**.
2. Select a user-defined calibration file to recalibrate.
3. Select **Recalibrate**.

The projector checks if the light source is on and the douser is open. If either condition is not met, a warning dialog is displayed prompting you to make sure these conditions are met before starting the wizard.
4. In step 1 of the Sensor-to-screen Calibration wizard, set the maximum brightness and color point.
  - a) Enable the **Display White Test Pattern** option.
  - b) Adjust the RGB sliders to set the brightness and color point.
  - c) Select **Next**.
5. Wait 20 minutes for the projector to stabilize or select **Skip** during the stabilization time period.
6. In step 2 of the Sensor-to-screen Calibration wizard, measure and enter the screen values.
  - a) To trigger the measurement at a specific operating point, under Sensor to screen, select **Capture**.

The Capture button changes color to indicate the capture process is activated. Only one Capture button is active at a time but the buttons can be selected in any order.

The projector automatically sets the red, green, and blue output laser powers to the pre-determined settings calculated and displayed in the Drive Percentage (Calculated) area of the wizard.

A 10 second countdown begins to allow the projector white point and brightness to stabilize and no changes can be made. At the end of the count down period, the Color Sensor values fields are automatically populated by the projector for the currently selected drive percentage value.
  - b) When the countdown ends, under Measured Values, using the numeric keypad capture and record the associated spectroradiometer values for x, y, and fL.

- The projector holds the on-screen color and brightness level until the same or another Capture button is selected.
- c) Repeat steps a and b for the remaining drive percentage set points until all x, y, and fL values are entered.
 

Spectroradiometer measurements can be captured in any order but all three x, y, and fL measurements must be entered before moving onto the next capture. You can recapture a specific measurement at any time during the process by selecting the Capture button. In this case, the measured spectroradiometer and color sensor values are reset.
  - d) Once all the color sensor and measured values are entered for all rows, select **Apply and Save**.
7. Verify and complete the calibration.
- a) Select a white point to measure by selecting either the **DCI**, **D65**, or **Custom** white point buttons.
 

Once selected, the projector automatically enables LiteLOC™, selects a White test pattern with uncorrected colors at the white point specified, and sets the brightness to 80%.
  - b) Using a spectroradiometer, measure screen x and y values at the center of the screen.
 

To verify the calibration has been successfully applied, the measured white point must be within the expected tolerance.
  - c) When complete, select **Finish**.
 

The projector output is configured according to the currently selected calibration file and you are returned to the Sensor-to-screen Calibration menu.

## Editing the existing calibration file parameters

Make corrections to the existing calibration file parameters, when the values from the spectroradiometer were entered in error.

1. Select **Menu > Color Settings > Sensor-to-screen Calibration**.
2. Select a user-defined calibration file.
3. Edit any of the x, y, or fL values by selecting the field under Measured Values and using the numeric keypad to enter the updated value.
  - x and y value range: 0.0001 to 0.9999
  - fL value range: 0.01 to 9999.99.
4. To save the updated file to the projector, select **Save**.

## Verifying the sensor-to-screen calibration

Check the integrity of the calibration, if required.

1. Navigate to **Menu > Color Settings > Sensor-to-screen Calibration**.
2. In the right toolbar, select **Test Patterns**. 
3. Select the **White** test pattern.
4. Close the Test Patterns window.
5. Select **Verify Calibration**.

If the douser is closed and/or the light source is off, a dialog is displayed informing the user that the douser must be open and the light source turned on before verification can occur.

Step 3 of the Calibration wizard opens.

6. Verify and complete the calibration.
  - a) Select a white point to measure by selecting either the **DCI**, **D65**, or **Custom** white point buttons.

Once selected, the projector automatically enables LiteLOC™, selects a White test pattern with uncorrected colors at the white point specified, and sets the brightness to 80%.
  - b) Using a spectroradiometer, measure screen x and y values at the center of the screen.

To verify the calibration has been successfully applied, the measured white point must be within the expected tolerance.
  - c) When complete, select **Finish**.

The projector output is configured according to the currently selected calibration file and you are returned to the Sensor-to-screen Calibration menu.

## Adding a calibration file to the Channel Setup

Select any of the available calibration files stored on the projector system by accessing the 2D Sensor-to-Screen Calibration File or 3D Sensor-to-Screen Calibration File list in the Channel Setup menu.

By default, the 2D and 3D sensor-to-screen calibration files are set to the factory or field calibration data identified as Default in the list. The Default selection references the factory calibration data as long as no field calibration data is available. If field calibration data is available, it is selected as the Default. When a 2D and 3D Sensor-to-screen Calibration file is selected in the Channel Setup, the active channel automatically applies the calibration data according to the 2D or 3D operation of the projector.

1. In the left navigation menu, select **Channel Setup**.
2. Select the channel you want to add the calibration file to.
3. From either the **2D Sensor-to-Screen Calibration File** or **3D Sensor-to-Screen Calibration File** list, select the calibration file.
4. Select **Save**.

# Managing user accounts

Learn how to create new user accounts, modify the properties of those accounts, and remove the accounts. A user account is a set of credentials consisting of both a username and password allowing access to projector settings.

## Default user access permissions

The following table lists the Christie touch panel access permissions.

Permission	Description
installer	Can define Ethernet settings (IP network address), restore backup files, and upgrade the system software.
manager	Can activate channels and test patterns, view detailed diagnostic logs for in-depth troubleshooting and view server errors. This is the default level.
marriage	Can access all user interface windows. Can authorize projector marriage.
operator	Can view basic projector status, diagnostic information and software version information. This is the default level for serial communication sessions.
service	Can access all user interface windows. Cannot authorize projector marriage.

## Adding a user account

Adding a user account allows users to access projector menus.

1. In the left navigation menu, select **Service Setup > User Accounts**.
2. Select **+**.
3. Complete the Name, Permissions, Password, and Confirm Password fields.
4. Select **Save**.

## Changing user account permissions

Change user account permissions to limit or increase access to projector menus and functionality.

1. In the left navigation menu, select **Service Setup > User Accounts**.
2. In the left pane, select a user account.
3. Select **Edit**.
4. In the Permissions list, select a new permissions setting.

5. Select **Save**.

## Changing a user account password

Periodically change a user account password to limit access to projector menus and functionality to authorized users.

1. In the left navigation menu, select **Service Setup > User Accounts**.
2. In the left pane, select a user account.
3. Select **Edit**.
4. Select **Change password**.
5. Complete the New Password and Confirm Password fields.
6. Select **Save**.

## Deleting a user account

Delete a user account to prevent access to projector menus and functionality.

1. In the left navigation menu, select **Service Setup > User Accounts**.
2. In the left pane, select a user account.
3. Select **Delete**. 
4. To confirm the deletion, select **Delete**.

# Network settings

Learn how to connect the projector to media devices and wired networks.



The system provides the MAC address of the projector automatically.

## Connecting the projector to the theater network

Connect the projector to the theater network to control it remotely and allow it to communicate with other network devices.

1. Connect the Ethernet cable from the theater network to the **Management** port on the input panel.
2. In the left navigation menu, select **Service Setup > Network Settings**.
3. Select the **Ethernet Settings** tab.
4. In the Port list, select **Management**.
5. Enter the network settings:
  - To obtain the network settings automatically, select **Automatic**.
  - To enter the settings manually, select **Manual** and complete these fields:

Field	Description
IP Address	IP address of the projector
Subnet Mask	Subnet mask to which the IP address belongs
Gateway	IP address for the network gateway
Primary DNS	IP address of the primary DNS server
Secondary DNS	IP address of the secondary DNS server

6. Select **Save**.

## Activating SNMP

Activate the Simple Network Management Protocol (SNMP) to monitor the theater network for conditions that indicate communication or hardware failures.

On CineLife+ 2K projectors, SNMP is enabled by default.

1. In the left navigation menu, select **Service Setup > Network Settings**.
2. Select the **SNMP** tab.
3. Select the **SNMP** slider.  
The color of the slider changes to blue to indicate it is active.



4. In the SNMP Settings area, select the SNMP version.
5. Complete the Trap Receiver IP fields.  
A trap receiver captures, displays, and logs SNMP traps. Traps are event notices sent immediately to the trap receiver from a network device. The SNMP device does not need to use resources to poll for these event notices.
6. In the Blocked SNMP Traps area, select the SNMP traps you want to block.
7. Select **Save**.

## Downloading MIB information

A Management Information Base (MIB) file contains the definitions for the device being managed by the SNMP protocol.

1. In the left navigation menu, select **Service Setup > Network Settings**.
2. Select the **SNMP** tab.
3. Select **Download MIB**.
4. Depending on your browser settings, browse to the location where you want to save the MIB file.
5. In the Name field, enter a name for the MIB file.
6. Select **Accept**.
7. Select **OK**.

# Managing content, playlists, and storage

Content, playlists, storage, and audio settings are managed through the Integrated Media Block (IMB). For detailed information on installing and operating the IMB, refer to the documentation provided with your IMB device. Tasks include the following:

- Installing the IMB in the projector
- Connecting portable or enterprise storage
- Managing content, including key delivery message (KDM) and security keys
- Managing and scheduling playback
- Setting up audio
- Setting up playback automation

# Setting up an integrated media block

Configure the CineLife+ 2K projector to work with an Integrated Media Block (IMB).

## Selecting Integrated Media Block (IMB) preferences

Choose from the available options to set the type of Integrated Media Block (IMB).

1. In the left navigation menu, select **Service Setup** > **Preferences**.
2. Select **IMB**.
3. In the Type list, select the manufacturer of the IMB model.
4. When the system prompts you to reboot the projector, select **Reboot**.
5. After the projector has restarted, log in with your user account.

## Activating marriage

After selecting the Integrated Media Block (IMB) type, you must install the IMB and complete marriage to display secure content and to comply with the Digital Cinema Initiatives (DCI) specification. You cannot complete marriage remotely.

You cannot complete marriage remotely because you must select the **Marriage** button on the input panel during the marriage process.

1. Verify the marriage ring is installed correctly and an anti-tamper alarm does not appear on the touch panel.
2. In the left navigation menu, select **Service Setup** > **Marriage Setup**.
3. Select **Start** and complete the Marriage Setup wizard.  
At the Arming stage, enter the Marriage password.
4. Select **Finish**.

## Enabling Integrated Media Block (IMB) Powered in Standby mode

Enable the projector to turn on the Integrated Media Block (IMB) to allow ingesting of content to the IMB when the projector is in Standby Mode.

1. To set the type of IMB, select **Service Setup** > **Preferences**.

2. Select **IMB**.
3. Enable the **IMB Powered in Standby** option.

# Working with channels

Create channels to store customized projector settings for different inputs.

## Adding a channel for HDMI input

Create a channel to store customized projector settings for input devices connected to the HDMI port.

1. In the left navigation menu, select **Channel Setup**.
2. Select **+ Create New Channel**.
3. In the Enter a new file name field, enter the channel name.
4. Select **Create**.
5. Complete these fields:

Field Name	Description
Input Type	Select the input signal sources from one of the following: <ul style="list-style-type: none"> <li>• HDMI Input - 1</li> <li>• HDMI Input - 2</li> </ul>
Data Format	Bit-depth, sampling format, and color space of the input signal are automatically determined from the metadata carried in the source. Auto (Default)
Scan Type	Scanning format of the input signal (interlaced or progressive) is automatically determined from the metadata carried in the source or by measuring scanning parameters of the source. Auto (Default)
3D Sync Input Mode	Specifies whether a specific frame of input data has left eye or right eye data. Auto (Default)
Color Space	The method of color decoding for the current source. Auto (Default)
ILS File	Intelligent Lens System™ (ILS) file associated with the channel.
2D Light Source File	2D light source file associated with the channel. Any changes made to the file settings are applied to all channels using this file.
3D Light Source File	3D light source file associated with the channel. Any changes made to the file settings are applied to all channels using this file.
2D Sensor-to-screen Calibration File	2D sensor-to-screen calibration file associated with the channel.
3D Sensor-to-screen Calibration File	3D sensor-to-screen calibration file associated with the channel.

Field Name	Description
2D MCGD File	Measured Color Gamut Data file associated with the 2D image.
3D MCGD File	Measured Color Gamut Data file associated with the 3D image.
TCGD File	Target Color Gamut Data file associated with the channel.
Screen File	Screen type, masking, cropping, and lens settings for the channel.
Gamma File	Gamma correction required for the proper tonal range of the source material.
3D File	3D settings files associated with the channel.
Source File	Resolution and aspect ratio for the channel.
Christie Pureformity Color™ Correction Files	Color correction file associated with the channel. Bypass (Default)
Warp File	Warp file associated with the channel. Bypass (Default)

6. Select **Create**.

## Adding a channel for Integrated Media Block (IMB) input

Create a channel to store customized projector settings for input devices connected to the Integrated Media Block (IMB).

1. In the left navigation menu, select **Channel Setup**.
2. Select **+ Create New Channel**.
3. In the Enter a new file name field, enter the channel name.
4. Select **Create**.
5. Complete these fields:

Field Name	Description
Input Type	Select IMB.
3D Sync Input Mode	For Christie IMB, specifies how 3D input data is encoded. <ul style="list-style-type: none"> <li>• Auto (Default)—Automatically encodes 3D input data.</li> <li>• 2D Mode—No 3D synchronization is applied.</li> </ul> 3D Sync Input Mode is not required when using the Christie IMB.
	For third-party IMBs, specifies how 3D input data is encoded. <ul style="list-style-type: none"> <li>• 2D Mode (Default)—No 3D synchronization is applied.</li> <li>• 3D Frame Interleaved—For input that contains left-eye data followed by right eye data.</li> <li>• 3D Frame Interleaved Inverted—For input containing right-eye data followed by left-eye data.</li> </ul>

Field Name	Description
	<ul style="list-style-type: none"> <li>• 3D White Line/Blue Line—For input including metadata describing the 3D encoding.</li> <li>• 3D White Line/Blue Line Inverted—For inverted input including metadata describing the 3D encoding.</li> <li>• 3D Line Interleaved—The left-eye and right-eye data are sent on alternating lines.</li> </ul> <p>For GDC IMB devices, the recommended setting is 3D Line Interleaved.</p>
ILS File	Intelligent Lens System™ (ILS) file associated with the channel.
2D Light Source File	2D light source file associated with the channel. Any changes made to the file settings are applied to all channels using this file.
3D Light Source File	3D light source file associated with the channel. Any changes made to the file settings are applied to all channels using this file.
2D Sensor-to-screen Calibration File	2D sensor-to-screen calibration file associated with the channel.
3D Sensor-to-screen Calibration File	3D sensor-to-screen calibration file associated with the channel.
2D MCGD File	Measured Color Gamut Data file associated with the 2D image.
3D MCGD File	Measured Color Gamut Data file associated with the 3D image.
TCGD File	Target Color Gamut Data file associated with the channel.
Screen File	Screen type, masking, cropping, and lens settings for the channel.
Gamma File	The gamma correction required for the proper tonal range of the source material.
3D File	3D settings file associated with the channel.
Source File	The resolution and aspect ratio for the channel.
Christie Pureformity Color™ Correction Files	The color correction file associated with the channel. Bypass (Default)
Warp File	Warp file associated with the channel. Bypass (Default)

6. Select **Create**.

## Selecting the active channel

Select a channel to use customized projector settings for different inputs.

1. In the right toolbar, select **All Channels**.  
The All Channels window displays the available channels and the active channel is highlighted.
2. Select a channel.  
In the Channel Setup panel, a green checkmark  indicates the active channel.
3. Select **Close**.

## Editing an existing channel

Edit an existing channel when the parameters of the input device change.

1. In the left navigation menu, select **Channel Setup**.
2. In the left pane, select a channel.
3. Edit the channel settings.
4. Select **Save**.

## Renaming a channel

Rename an existing channel.

1. In the left navigation menu, select **Channel Setup**.
2. In the left pane, select a channel.
3. Select **Rename Channel**.
4. Enter a new name.
5. Select **Rename**.

## Copying existing channel settings to a new channel

Copy a channel to create a new channel with similar settings.

1. In the left navigation menu, select **Channel Setup**.
2. In the left pane, select a channel.
3. Select **Save As**.
4. Enter a name for the new channel and select **Save**.
5. If input type changes, check all settings.

## Viewing the channel list



The channel list displays all of the available channels.

- In the left navigation menu, select **Channel Setup**.  
Under Channel Setup, the available channels are displayed in the left pane. A green checkmark  indicates the active channel.  
Alternatively in the right toolbar, select **All Channels**.  
The Channels window displays the available channels and the active channel is highlighted.



## Moving a channel up or down the channel list

If a channel is selected frequently, move it to the top of channel list for convenient access. If not selected frequently, move it to the bottom of the channel list.

1. In the left navigation menu, select **Channel Setup**.
2. In the left pane, select a channel.
3. To move the channel up or down the list, select  or .

## Deleting a channel

Delete a channel when the settings for the input device are no longer required.

1. In the left navigation menu, select **Channel Setup**.
2. In the left pane, select a channel.
3. Select **Delete**. 
4. To confirm the deletion, select **Delete**.

# Managing color setting files

Use the procedures in this section to manage color setting files. When associated with a channel, a color setting file defines the color output for the content.

## Creating an MCGD file

Create Measured Color Gamut Data (MCGD) files to correct on-screen colors. A colorimeter is required to complete this procedure.

1. Activate the channel using the light source file the MCGD file is being created for.
2. Turn on the light source and allow it to operate for 20 minutes.
3. In the left navigation menu, select **Color Settings > MCGD File Setup**.
4. Select **Create**.
5. Enter a name for the MCGD file and select **Create**.
6. If the MCGD file will be associated with a 3D channel, select the **3D Sync** slider.
7. In the red area of the chromaticity image, select the empty circle.  
The test pattern is automatically displayed.
8. Measure the red chromaticity with the colorimeter.
9. Enter the red chromaticity value in the **x** field.
10. Select **Next** and enter the red chromaticity value in the **y** field.
11. For the green, blue, white (center circle), and black chromaticity measurements, repeat steps 7 to 10.
12. Select **Save**. 

## Editing an existing MCGD file

Edit an existing Measured Color Gamut Data (MCGD) file when on-screen color readings change.

1. In the left navigation menu, select **Color Settings > MCGD File Setup**.
2. In the MCGD File list, select a MCGD file.
3. Edit the measured color values.
4. Select **Save** .

## Copying existing MCGD file settings to a new file

Copy an existing Measured Color Gamut Data (MCGD) file when you want to create a new MCGD file with similar settings.

1. In the left navigation menu, select **Color Settings > MCGD File Setup**.
2. In the MCGD File list, select a MCGD file.
3. Select **Save As.** 
4. Enter a name for the MCGD file and select **Save**.

## Deleting an MCGD file

Delete a Measured Color Gamut Data (MCGD) file when it is no longer required.

1. In the left navigation menu, select **Color Settings > MCGD File Setup**.
2. In the **MCGD File** list, select a MCGD file.
3. Select **Delete.** 
4. To confirm the deletion, select **Delete**.

## Creating a TCGD file

Typically, Target Color Gamut Data (TCGD) file settings are defined by the content provider and are not modified. A colorimeter is required to complete this procedure.

1. Turn on the light source and allow it to operate for 20 minutes.
2. In the left navigation menu, select **Color Settings > TCGD File Setup**.
3. Select **Create**.
4. Enter a name for the TCGD file and select **Create**.
5. To display test clips automatically when selecting a color in the chromaticity image, select **Automatically Display Test Clip**.
6. To modify the white clipping values and improve image detail in bright areas of the image, select **Use White Clip**.
7. Select the option button in the red area of the chromaticity image to display the red test pattern.
8. Measure the red chromaticity with the colorimeter.
9. Enter the red chromaticity values in the **Red x** and **Red y** fields.
10. Adjust the **Gain** value to modify the color brightness.
11. For the magenta, blue, cyan, white, yellow, and green chromaticity measurements, repeat steps 7 to 10.
12. To adjust the color of the white light in a specific area of the screen, select **White Tolerance** and a screen area.
13. Select **Save.** 

## Editing an existing TCGD file

Edit an existing Target Color Gamut Data (TCGD) file when color readings change.

1. In the left navigation menu, select **Color Settings > TCGD File Setup**.
2. In the **TCGD File** list, select a TCGD file.
3. Edit the TCGD file settings.
4. Select **Save**. 

## Copying existing TCGD file settings to a new file

Copy an existing Target Color Gamut Data (TCGD) file when you want to create a new TCGD file with similar settings.

1. In the left navigation menu, select **Color Settings > TCGD File Setup**.
2. In the TCGD File list, select a TCGD file.
3. Select **Save As**. 
4. Enter a name for the TCGD file and select **Save**.

## Deleting a TCGD file

Delete a Target Color Gamut Data (TCGD) file when it is no longer required.

1. In the left navigation menu, select **Color Settings > TCGD File Setup**.
2. In the TCGD File list, select a TCGD file.
3. Select **Delete**. 
4. To confirm the deletion, select **Delete**.

# Adjusting the image size and position

Learn how to enable and modify projector image settings.

## Intelligent Lens System (ILS)

The Intelligent Lens System™ (ILS) automatically recognizes and calibrates a lens.



Warping is disabled when entering the ILS Setup page.

## Activating the Intelligent Lens System



Activate the Intelligent Lens System™ (ILS) to automatically adjust the position of the lens.

On CineLife+ 2K projectors, the ILS is enabled by default.

1. In the left navigation menu, select **Service Setup** > **Preferences**.
2. Select **Lens/ILS**.
3. In the right pane, select the **ILS Installed** slider.  
The color of the slider changes to blue to indicate the ILS is active.

## Creating a new ILS file

Create an Intelligent Lens System™ (ILS) file to set the X, Y, zoom, and focus positions of the lens.

1. In the left navigation menu, select **Image Settings** > **ILS File Setup**.
2. Select **Create**. 
3. Enter a name for the ILS file and select **Create**.
4. In the Lens position area, select the forward, backward, left, or right arrow icons to move the position of the image on the screen.
5. In the **Focus** area, select **Up** (^) or **Down** (v) to increase or decrease image focus.
6. In the **Zoom** area, select **Up** (^) or **Down** (v) to increase or decrease image zoom.
7. Select **Save**. 

## Automatically calibrating the ILS

Use the Auto Calibrate feature of the Intelligent Lens System™ (ILS) to find and compensate for motor backlash, and to determine the movement range for the currently installed lens.

1. In the left navigation menu, select **Image Settings > ILS File Setup**.
2. Select **Auto Calibrate**.
3. In the confirmation dialog, select **Continue**.

## Editing ILS file settings

Edit Intelligent Lens System™ (ILS) file settings when content requirements change.

1. In the left navigation menu, select **Image Settings > ILS File Setup**.
2. On the right side, in the ILS File list, select an ILS file.
3. Modify the ILS file settings.
4. Select **Save**. 

## Copying existing ILS file settings

To duplicate Intelligent Lens System™ (ILS) file settings quickly, copy the settings of an existing file to a new ILS file.

1. In the left navigation menu, select **Image Settings > ILS File Setup**.
2. In the ILS File list, select the ILS file you want to copy.
3. Select **Save As**. 
4. Enter a name for the ILS file and select **Save**.

## Deleting an ILS file

Delete an Intelligent Lens System™ (ILS) file when it is no longer required.

1. In the left navigation menu, select **Image Settings > ILS File Setup**.
2. In the ILS File list, select the ILS file you want to delete.
3. Select **Delete**. 
4. To confirm the deletion, select **Delete**.

## Resetting the lens

Use the Reset Lens feature to have the Intelligent Lens System™ (ILS) find the home position flags that allow the ILS to compensate for drift over time, or move to its proper position after it has been manually adjusted.

1. In the left navigation menu, select **Image Settings > ILS File Setup**.
2. Select **Reset Lens**.
3. In the confirmation dialog, select **Continue**.

## Electronic Color Correction (ECC)

A lateral convergence error occurs when the red, green, and blue (RGB) primary colors are not converged through projected lenses and is most noticeable at the edges of the screen. To address this, use ECC.

Electronic Color Correction (ECC) is accomplished by aligning a red, green, and blue sprite, which is displayed at the four corners of the displayed image. For electronic convergence all three colors can be adjusted.

Always align the color components of the sprite to the inner most line color (for each axis). When converged, the three colors should overlap to form white lines. Applying the sprite alignment settings to the screen results in the three colors overlapping to form white lines throughout the image.

One or more poorly converged individual colors may appear adjacent to some or all of the lines.

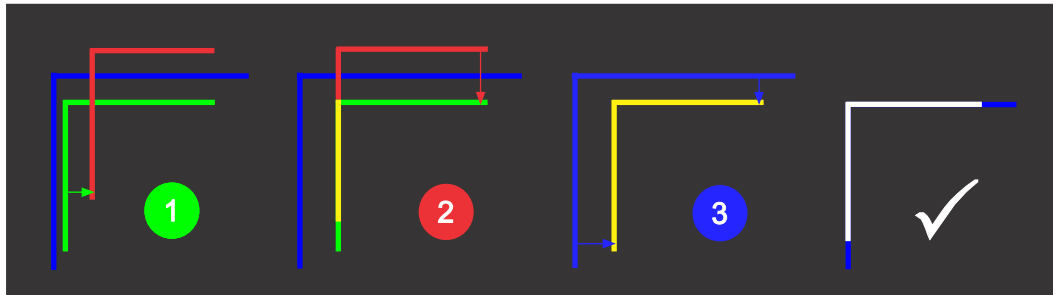

If you wear glasses with corrective lenses when performing this adjustment, make sure you are viewing the test pattern on a straight angle through the optical axis of your glasses and not from a tilted or angled perspective. This avoids a prismatic effect that can appear to shift convergence when viewing at an angle.

## Electronically adjusting convergence

Use the electronic color correction (ECC) feature in the menu to adjust convergence. Only perform electronic convergence when satisfied with the position of the image on the screen.

1. In the left navigation menu, select **Image Settings > ILS File Setup**.
2. Use the arrow to select an ILS file to store the ECC settings.
3. On the ILS File Setup page, select **ECC**.  
Each corner of the screen displays three separate sprites, one for each primary color. The user interface displays the Test Pattern controls.
4. Set the Screen Type to **Flat** or **Scope**.  
This sets the test pattern and the location of the sprites on the screen. Each sprite appears as the letter L.
5. Set the Sprite Color to **Move** and **Show**.  
When first opening the ECC, all Show and all Move colors are selected, so all three sprites are displayed and all three sprites are moved by the directional pad.
6. Select a **Step Size** to control the granularity of the steps from coarse (1/8 pixel per step) to fine (1/64 pixel per step) when using the directional pad.  
Sprites can be moved a maximum of 20 pixels.
7. Choose a corner by selecting the circle at a corner of the dashed rectangle.  
The selected corner is indicated by a green circle. The X/Y pixel offset (from no correction) displays in red, green, and blue text corresponding to each sprite.

8. Use the directional pad to move the sprites towards the center of the screen.
9. Adjust each sprite so they overlap to create a single white sprite.  
 In the example below, the red sprite (in image 1 below) was moved down and the blue sprite (in image 1 below) was moved to the right so they overlap to create the single white sprite (image 2 below).

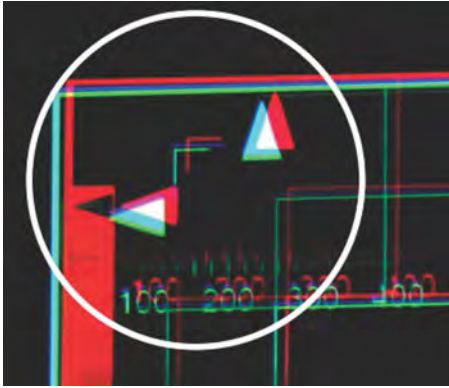

1

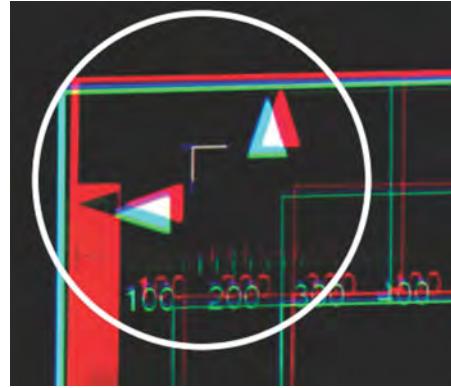

2

10. To set the convergence for that corner of the screen, select **Apply**.





11. Repeat steps 7 to 10 for the remaining corners.
12. If necessary, reset the correction back to zero (no correction) or the previously saved correction by selecting **Reset**.  
 In the Reset dialog, reset the current corner or all four corners. When the locations and value are set, select **Reset**.
13. To save the current ECC settings, when the convergence is complete, select **Save** beside the ILS file named at the top of the panel.



## Creating a source file

Create source files to store resolution, offset, and aspect ratio settings for input devices. When the Auto Square Pixels file is selected, the incoming video format is automatically detected.

1. In the left navigation menu, select **Image Settings > Source File Setup**.
2. Select **Create**. 
3. Enter a name for the source file and select **Create**.
4. In the Source Media Resolution area, adjust the width and height of the source media.
5. Select an aspect ratio or enter a custom aspect ratio for the source media.
6. In the Position area, adjust the horizontal and vertical position of the source media.
7. Select **Save** .

## Editing source file settings

Edit source file settings when the settings of the input device change.

1. In the left navigation menu, select **Image Settings > Source File Setup**.
2. In the Source File list, select a source file.
3. Modify the source file settings.
4. Select **Save**. 

## Copying existing source file settings to a new source file

To duplicate existing source file settings quickly, copy the settings of an existing file to a new source file.

1. In the left navigation menu, select **Image Settings > Source File Setup**.
2. In the Source File list, select the source file you want to copy.
3. Select **Save As**. 
4. Enter a name for the source file and select **Save**.

## Deleting a source file

Delete a source file when it is no longer required.

1. In the left navigation menu, select **Image Settings > Source File Setup**.
2. In the Source File list, select the source file you want to delete.
3. Select **Delete**. 
4. To confirm the deletion, select **Delete**.

## Creating a screen file

Use screen files to define the size of the display panel and image cropping. You can assign the same screen file to multiple input devices.

1. In the left navigation menu, select **Image Settings > Screen File Setup**.
2. Select **Create Screen File**. 
3. Enter a name for the screen file and select **Create**.
4. To crop the image in a specific location, select one of the screen icons.

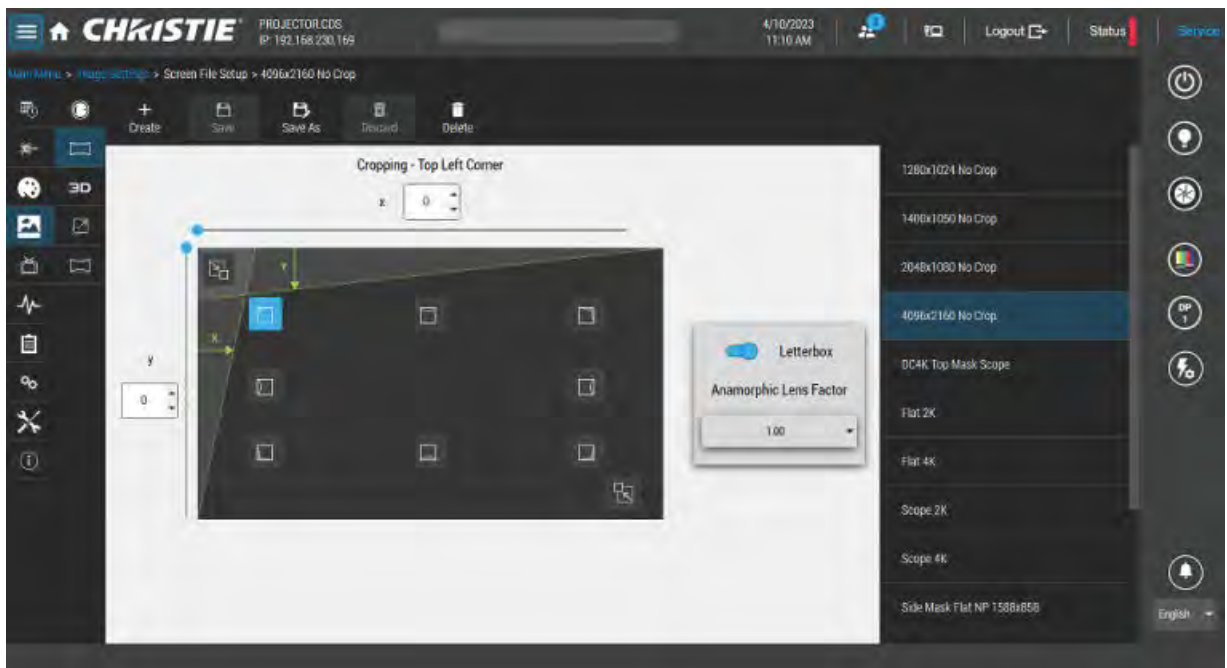

5. To adjust the amount of cropping on the X or Y axis, move the slider up or down.
6. To display all image data and maintain the aspect ratio, select the **Letterbox** slider. The color of the slider changes to blue to indicate it is active.
7. If required, adjust the **Anamorphic Lens Factor** value to match the lens installed.
8. Select **Save**. 

## Editing screen file settings

Edit screen file settings when the image parameters change.

1. In the left navigation menu, select **Image Settings > Screen File Setup**.
2. In the Screen File list, select a screen file.
3. Modify the screen file settings.
4. Select **Save**. 

## Copying existing screen file settings to a new screen file

To duplicate screen file settings quickly, copy the settings of an existing file to a new screen file.

1. Select **Image Settings > Screen File Setup**.
2. In the Screen File list, select the screen file you want to copy.
3. Select **Save As** .
4. Enter a name for the source file and select **Save**.

## Deleting a screen file

Delete a screen file when it is no longer required.

1. In the left navigation menu, select **Image Settings > Screen File Setup**.
2. In the Screen File list, select the screen file you want to delete.
3. Select **Delete**. .
4. To confirm the deletion, select **Delete**.

## Activating a warp file

Activate a warp file to use with a selected channel.

Warp files provide image configuration information to support projection in environments with multiple projectors and complex screen shapes. Warp files are created using an automated process through Christie Mystique.

For more information on using Christie Mystique in a cinema environment, see the *Mystique User Guide—Cinema Edition (P/N: 020-001240-XX)*.

1. Using Christie Mystique, create the required warp file.
2. Using Mystique, upload the warp file to the projector.
3. On the projector touch panel, navigate to **Image Settings > Warp File Setup**.
4. To activate the warp file, find the file name in the Warp File list and select **Activate**.



If you no longer require a warp file, remove it by selecting **Image Settings > Warp File Setup**. Find the warp file in the list and select **Delete**. .

# Adjusting the image

Adjust the projector image. Christie recommends warming the lens before completing these procedures as focus may change as the lens warms.

## Correcting vignetting

An image that is brighter at the center than it is at the sides needs vignetting correction.

If your image suffers from vignetting, the lens has reached the end of its offset travel range.

If your installation does not allow the image to be centered with the center of the screen, move the entire projector in the direction of lens travel.

## Correcting keystone effect

Keystone effect occurs when you project an image onto the screen at an angle. As a result, the image appears distorted and resembles a trapezoid.



When making the adjustments, set the light source to minimum power.

Horizontal keystone	Vertical keystone
<p>Projector skewed horizontally to the screen</p>	<p>Projector tilted vertically to the screen</p>

1. If the image suffers from slight keystone effect, it can be corrected with electronic cropping.
2. If the keystone effect is severe, unevenly adjust the feet to compensate for projector tilt.  
Christie recommends using the lens offset to align the center of the image to the center of the screen before correcting the keystone effect.

3. If one side of the image is longer than another, adjust the tilt and level of the projector.

## Masking the screen edges

Conceal the unused edges of a screen with top or side masking.

Typically, you install top and side masking to allow a greater range of adjustment.

1. To create top masking:
  - a) Install movable flat black panels or curtains along the top edge of the screen.
  - b) Raise the curtain for flat images or lower the curtain for scope images.

**Top masking theater (1.85 screens)**

A	1.85 image
B	2.39 image
C	Masking moved up
D	Top masking to hide screen top

2. To create side masking:
  - a) Install movable flat black panels or curtains along each side of the screen.
  - b) Close the curtain for flat images or open the curtain and zoom for scope images.

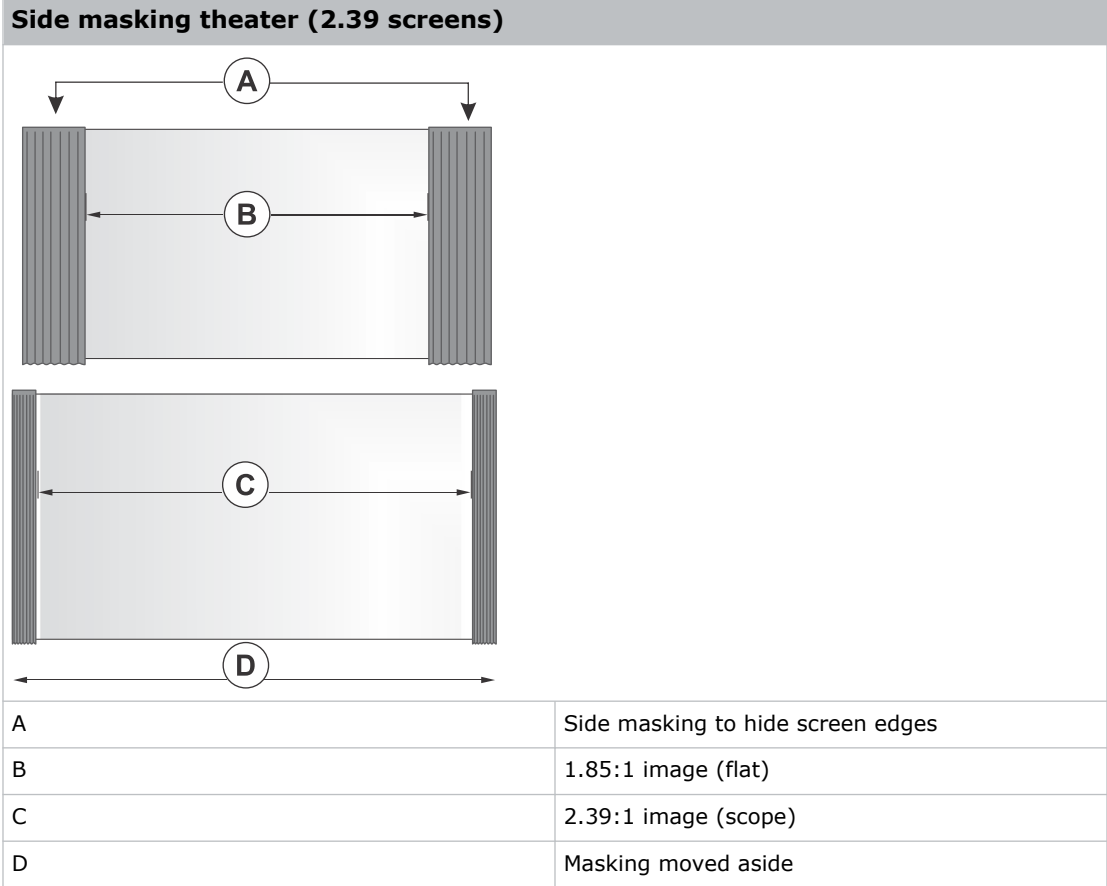

# Test patterns

Use the available test patterns to assist with configuration of the projector and to diagnose any issues that may occur.

## Displaying a test pattern

Display a test pattern to refine and adjust the projected image or to diagnose and correct image issues.

1. In the right toolbar, select **Test Patterns**. 
2. Select **Full Screen** or **Uncorrected Colors**.
3. Select a test pattern.  
When a test pattern is active, a blue bar appears below the test pattern icon in the right pane.
4. To display a 2D test pattern in 3D mode, select the **3D Sync** option.  
The **3D Sync** option is selected automatically for 3D test patterns. 3D test patterns cannot be displayed in 2D mode.
5. To change the frame rate of the test pattern display, select from the available Frame Rate options:
  - For 2D test patterns, the available frame rates are 24, 30, 48, and 60 Frames Per Second (FPS). The default value is 24 FPS.
  - For 3D test patterns, the available frame rates are 48 and 60 FPS. The default value is 48 FPS.

Changing the frame rate of the display can assist with color measurement when working with corrected colors.

When changing the frame rate option, the option is applied to the next test pattern you select unless it is not available for that pattern. If a selected frame rate is not available, the default frame rate is applied for the test pattern display.

## Turning off a test pattern

Turn off a test pattern when adjustment of the projected image is complete.

1. In the right toolbar, select **Test Patterns**. 
2. Select **Test Pattern Off**.

## Importing a test pattern

Import custom test patterns to meet the specific requirements of your viewing environment.

1. In the right toolbar, select **Test Patterns**. 
2. In the upper right corner, select **Edit**.
3. Select **Import**.
4. Browse to the location of the test pattern file.
5. Select the test pattern file.
6. Select **Open**.
7. In the upper right corner, select **Done**.

## Deleting a test pattern

Delete a test pattern no longer required. A test pattern with **RGB** in the name cannot be deleted.

1. In the right toolbar, select **Test Patterns**. 
2. In the upper right corner, select **Edit**.
3. Select a test pattern.
4. Select **Delete**.
5. To confirm the deletion, select **Delete**.
6. In the upper right corner, select **Done**.





# Working with the scheduler

Use the scheduler to schedule automated events that play automatically on a specific date at a specific time.

## Scheduling automation

Schedule automation to run automatically on a specific date and time.

On CineLife+ 2K projectors, the scheduler is enabled by default.

1. In the left navigation menu, select **Scheduler**.
2. To enable scheduled events, move the **Scheduler is off** slider to the right. The color of the slider changes to blue to indicate it is active.
3. To select a date for the scheduled event, select **Calendar**. 
4. Select the week.
5. Select a square below the date and next to the time you want the event to run.
6. Select **+ New Event**.
7. In the Macros tab, select a macro.
8. Select the start time.
9. Select the start date.
10. To repeat the event daily, weekly, or monthly:
  - a) Select the **Recurrence** slider.
  - b) Select the frequency of the recurrence. The options are daily, weekly, or monthly.
  - c) Select the days or months you want the playlist, content, or automation event to play.
  - d) To select an end date for the schedule, select **Calendar**. 
11. To prevent the scheduled event from being overwritten, select the **Lock Event** slider. Locked events cannot be overwritten by pasted events.
12. Select **Create Event**.

## Editing a scheduled event

Edit a scheduled event to modify the run time and date.

1. In the left navigation menu, select **Scheduler**.

2. In the calendar view, select the scheduled event.
3. Select **Edit**.
4. Edit the scheduled event settings.
5. Select **Update Event**.

## Copying and pasting an existing scheduled event

To run a scheduled event at a different date and time, copy and paste it.

1. In the left navigation menu, select **Scheduler**.
2. In the calendar view, select the scheduled event.
3. Select **Copy**.
4. Select a square below the date and next to the time you want the event to run.
5. Select **Paste**.
6. Adjust the settings for the scheduled event.
7. Select **Paste Event**.

## Copying and pasting scheduled events for an entire day

To run an existing full day of scheduled events on a different date, copy and paste the entire day of scheduled events.

1. In the left navigation menu, select **Scheduler**.
2. At the top of the calendar, select the day with the events you want to copy.
3. Select **Copy**.
4. At the top of the calendar, select the new target day.
5. Select **Paste**.  
Only unlocked events are copied to the new day.

## Cutting and pasting a scheduled event

To move an existing scheduled event to a different date and time, cut and paste it.

1. In the left navigation menu, select **Scheduler**.
2. In the calendar view, select the scheduled event.
3. Select **Cut**.
4. Select the new date in the calendar.
5. Select **Paste**.
6. Adjust the settings for the scheduled event.

7. Select **Paste Event**.  
Only unlocked events are copied.

## Deleting a scheduled event

Delete an individual scheduled event when it is no longer required.

1. In the left navigation menu, select **Scheduler**.
2. In the calendar view, select the scheduled event.
3. Select **Delete**.
4. To confirm the deletion, select **Delete**.

## Deleting scheduled events for an entire day

Delete the scheduled events for an entire day when they are no longer required.

1. In the left navigation menu, select **Scheduler**.
2. At the top of the calendar, select the target day.
3. Select **Clear Day**.
4. To confirm the change, select **Clear Day**.

## Changing the day of the week the scheduler starts

Change the start day of the scheduler to match the schedule of the theater.

1. In the left navigation menu, select **Service Setup > Preferences**.
2. Select **General**.
3. In the Scheduler area, select the day of the week to start the scheduler.

## Turning off the scheduler

Turn off the scheduler when you do not want scheduled events to run automatically on a specific date and time.

1. In the left navigation menu, select **Scheduler**.
2. To disable scheduled events, move the **Scheduler is on** slider to the left.  
The color of the slider changes to grey to indicate it is inactive.

# Automation

Use automation to control playback, the projector, and external devices.

- **Macros**—A macro is a list of actions you define. For example, opening the curtains or turning on the house lights at the end of playback. A macro can be activated by a global trigger or it can be added to a playlist.
- **Device Input Triggers**—Input cues wait for events, such as a general purpose input (GPI) state change or an Ethernet message received on the projector management IP address port 5111. An input cue in a playlist delays playback until an event occurs.
- **Global Triggers**—A global trigger combines an input cue with a macro. When the predefined event for the input cue occurs, the output macro is triggered. For example, a fire alarm input signal could cause playback to stop and the house lights to come on. A global trigger is always active and is not dependent on specific playlist definitions.

## Available macro actions

The following macro actions are available to control automated events.

Action item	Available actions	Description
Automation	Set Global	Sets a global variable to be used in automation scripting (intended for advanced scripting by Christie).
	Print	Generates a projector log entry when an automation macro runs.
	Get Global	Allows the automation script to read the value of a global variable (intended for advanced scripting by Christie).
	Set GPO	Sets the specified GPO pin to high or low.
	Pulse GPO	Pulses the specified GPO pin.
	Get GPI	Allows an automation script to read the GPI state (intended for advanced scripting by Christie).
	Delay	Delays macro execution.
	Wait On GPI	Pauses the automation script and waits for the specified GPI event to enter the specified state.
Projector	Douser Open	Opens the douser (shutter).
	Douser Close	Closes the douser (shutter).
	Light On	Turns the light on.
	Light Off	Turns the light off.
	Standby	Puts the projector in standby mode.
	Channel	Selects a specific projector channel.

Action item	Available actions	Description
	Revert Warp File	Reverts the active warp file to its previous settings.
	Full Power	Places the projector in full power mode.
	Wait	Delays the execution of a macro.

## Fire alarm macro

By default, the projector is configured with a macro using a building fire alarm as the trigger.

If the projector is connected the building's fire alarm system (recommended installation), the default FIRE\_ALARM macro puts the projector into Standby mode if a fire alarm occurs.

You can also create a custom macro that uses the fire alarm trigger or edit the default fire alarm macro to perform other actions as needed.

## Christie ACT actions

The following built-in commands are available for Christie ACT.

Command	Description
Buzzer	Activates the buzzer for the specified time (in milliseconds).
Button	Simulates pressing or holding the ACT button.
Pulse Relay	Sends a pulse to a specific relay.
Open Relay	Opens a specific relay.
Close Relay	Closes a specific relay.
Pulse GPO	Sends a pulse to a specific GPO pin.
Set All GPOs	Sets the values for all GPO pins.
Run Script	Runs a script on the Christie ACT.
Flash LED	Causes a specific LED to flash.
Set All LEDs	Sets values for all of the LEDs.

## JNIOR actions

The following built-in commands are available for JNIOR devices.

Command	Description
Open Relay	Opens a specific JNIOR relay
Close Relay	Closes a specific JNIOR relay
Pulse Relay	Sends a pulse to a specific JNIOR relay for the specified time (in milliseconds)
Execute Macro	Executes a JNIOR macro

Christie provides three JNIOR libraries.

Christie library	Relay outputs	JNIOR model supported
JNIOR	8	JNIOR 310, JNIOR 410
JNIORx12	12	JNIOR 312, JNIOR 412
JNIORx16	16	JNIOR 412 with a 4-relay output expansion model

Note the following:

- You can create macros on the JNIOR device and call them using the `Execute Macro` command. Make sure you use `\\0D` for a carriage return and `\\0A` for a line feed. To create and run macros on the JNIOR, use the JNIOR Support Tool to enable and configure the Cinema.JNIOR application. For additional information, see INTEG Process Group (<https://jnior.com>). Port 9200 is the default Ethernet port for sending automation commands to the JNIOR.
- The jnior login must be disabled on the JNIOR device and the jnior username and password removed in the Christie software to allow the cues to pass over the network.

## Dolby cinema processor actions

The following built-in commands are available for Dolby CP650, CP750, CP850, CP950, and CP950A devices:

Command	Description
Mute On/Mute Off	Enables or disables muting.
Set Format (CP650 only)	Selects the format.
Set Fader Level	Sets the fader level.
Send Message	Sends the specified message.

If you need to control additional functions and a built-in command is not available, send a command string in a macro. For example, send this command to enable surround boost on the Dolby CP750: `cp750.sys.surround_boost 1\\0D`

Make sure you include a carriage return (`\\0D`) at the end of each command. For more information about controlling other features with serial commands, see the Dolby CP750 documentation.

The default Ethernet port for sending automation commands to the Dolby CP650 is port 61412. For Dolby CP750, CP850, CP950, and CP950A, the default Ethernet port is port 61408.

## SKA-3D actions

The following built-in commands are available for SKA-3D devices:

Command	Description
Set Audio Input Channel	Sets the audio input channel.
Mute On/Mute Off	Enables or disables muting.
Set Main Volume	Sets the overall volume for the system.

Command	Description
Set Video Input Channel	Sets the video input channel.
Active Trigger Input	Controls eight SKA-3D presets. To use this command, a trigger input must be associated with each of the SKA-3D presets.

## Creating a macro

Create a macro to make the projector perform a specific list of actions.

1. In the left navigation menu, select **Automation > Macro Editor**.
2. Select **+ Create New Macro**.
3. Enter a name for the macro.  
The Name field cannot contain spaces.
4. Select the macro type.
5. Select **Create**.
6. Add an action item to the macro:
  - a) In the right pane, select **+**.
  - b) In the Add New Action Item dialog, select My Auditorium.
  - c) Under Automation or Projector, select an action item.
7. Select **Create**.
8. To save the macro, select **Save**.
9. To test the macro, select **Test**.

## Running a macro

Run a macro to have the projector perform a specific list of actions.

1. In the right pane, select **Macro Selection**. 
2. Select a macro.

## Adding an action item to an existing macro

Add an action item to a macro to have the projector perform an additional action when the macro runs.

1. In the left navigation menu, select **Automation > Macro Editor**.
2. In the left pane, select a macro from the list.
3. Add an action item to the macro:
  - a) In the right pane, select **+**.
  - b) Under Automation, Playback, or Projector, select the action item.
4. Select **Create**.

5. To save the macro, select **Save**.
6. To test the macro, select **Test**.

## Adding a macro to an existing macro

Combine macros to have the projector complete a complex set of actions.

1. In the left navigation menu, select **Automation > Macro Editor**.
2. In the left pane, select a macro.
3. In the right pane, select **+**.
4. In the Add New Action Item dialog, select **Macros**.
5. Select a macro.
6. Select **Create**.
7. To save the macro, select **Save**.
8. To test the macro, select **Test**.

## Deleting a macro

Delete macros when they are no longer required.

1. In the left navigation menu, select **Automation > Macro Editor**.
2. In the left pane, select a macro.
3. Select **Delete**. 
4. To confirm the deletion, select **Delete**.

## Creating, editing, and deleting playlist triggers

Playlist triggers are configured and managed through the Integrated Media Block (IMB).

For more information, refer to the documentation provided with your IMB device.

### Creating a new global trigger

Create a global trigger to trigger an output macro. For example, a fire alarm input signal could cause playback to stop and the house lights to come on. A global trigger is always active and is not dependent on specific playlist definitions.

1. In the left navigation menu, select **Automation > Device Input Triggers**.
2. Select **+ New Global Trigger**.
3. Complete the Name, Source, and Trigger Event fields.  
The Name field cannot contain spaces.
4. In the Macro Name list, select the macro that will run on trigger detection.
5. Select **Add**.



## Editing existing global trigger settings

Edit the settings of an existing global trigger to change its behavior.

1. In the left navigation menu, select **Automation > Device Input Triggers**.
2. To the right of the global trigger you want to edit, select **Edit**.
3. Edit the global trigger settings.
4. Select **Save**.

## Deleting a global trigger

Delete a global trigger when it is no longer required.

1. In the left navigation menu, select **Automation > Device Input Triggers**.
2. To the right of the global trigger, select **Delete**.
3. To confirm the deletion, select **Delete**.

## Adding an automation device to your auditorium

Add an automation device so it can be controlled remotely and can communicate with other theater hardware.

1. In the left navigation menu, select **Automation > My Auditorium Devices**.
2. Select **+ New Device**.
3. In the Name field, enter a name for the device.  
The Name field cannot contain spaces.
4. In the Device Type list, select the device type.
5. In the Select Device list, select the device.
6. Select **Add**.
7. Complete these fields:
  - **IP Address**—The IP address of the automation device.
  - **Port**—The port used by the automation device to communicate with the projector.
  - **Username**—The username used to access the automation device.
  - **Password**—The password used to access the automation device.
  - **Keep Alive Message**—The message value sent to the automation device to make sure the projector is not disconnected when inactive.
  - **Keep Alive Interval (ms)**—The time interval (in milliseconds) for sending the Keep Alive Message to the automation device.
8. Select **Save**.  
The added device is displayed in the list of auditorium devices in the Macro Editor.

## Modifying automation device settings

Modify the settings of automation devices when parameters such as the username or password change. If the settings are not updated, the automation device might not be able to communicate with other theater hardware or be controlled remotely.

1. In the left navigation menu, select **Automation > My Auditorium Devices**.
2. In the left pane, select an automation device.
3. Modify these fields:
  - **IP Address**—The IP address of the automation device.
  - **Port**—The port used by the automation device to communicate with the projector.
  - **Username**—The username used to access the automation device.
  - **Password**—The password used to access the automation device.
  - **Keep Alive Message**—The message value sent to the automation device to make sure the projector is not disconnected when inactive.
  - **Keep Alive Interval (ms)**—The time interval (in milliseconds) for sending the Keep Alive Message to the automation device.
4. Select **Save**.

## Removing an automation device from your auditorium

Remove an automation device when it is no longer required, or it has been physically removed from the theater.

1. In the left navigation menu, select **Automation > My Auditorium Devices**.
2. In the left pane, select an automation device.
3. Select **Delete**.
4. To confirm the deletion, select **Delete**.

## Importing a device library

A device library contains commands used to control a specific device.

1. In the left navigation menu, select **Automation > Device Libraries**.
2. Select **Import Device Library**.
3. Browse to the location of the device library file.
4. Select the file and select **Open**.

## Viewing a device library

View device libraries to determine if a library exists for the network device.

1. If the device library is not in the list, import it.

2. In the left navigation menu, select **Automation > Device Libraries**.
3. To the right of the device in the View Library column, select **View Library**.  
Review the list of actions available for the device.
4. To exit the dialog, select **OK**.

## Deleting a device library

Delete a device library when it is no longer required.

1. In the left navigation menu, select **Automation > Device Libraries**.
2. To the right of the device library, select **Delete**.
3. To confirm the deletion, select **Delete**.

# Rental mode

Rental Mode licenses are applied to the projector and control the operation of the projector. Rental Mode supports all CineLife+ 2K projectors. The Brightness Restriction functionality is only available for CineLife+ projectors running v1.3.0 or later.

## Applying a rental mode license file

If your projector is a rental unit provided by a vendor, you must apply a rental license to enable certain features.

1. Save the license file in one of the following ways.
  - Using the touch panel control—Save the file to a USB flash drive.
  - Using the web user interface—Save the file to a location on your computer.
2. If using the touch panel control, insert the USB flash drive in the USB port on the projector faceplate.
3. In the right toolbar, select **Rental Mode**. 
4. In the Rental Licenses window, select **Import License**.
5. In the Open File dialog, navigate to the folder containing the license ZIP file and select the file from the list.
6. Select **Open**.  
The system displays the rental licenses information.

## Viewing rental mode license expiry

View the days remaining and expiry date of the applied rental license.

1. In the right toolbar, select **Rental Mode**. 
2. In the Rental Licenses window, view the following information:
  - Days remaining
  - Expiry date

When a license is nearing expiration, the license information box changes color and the system displays an alert on the Rental Mode icon. 

Warning/alarm	Threshold
Hours warning	140 hours (14 days @ 10 hours/day)
Hours alarm	30 hours (3 days @ 10 hours/day)
Duration warning	14 days
Duration alarm	3 days

# Backing up, restoring, and upgrading files

Learn how to back up, restore, and upgrade files.

## Creating a new backup file

Create a new backup file to restore projector settings if a failure occurs.

1. In the left navigation menu, select **Service Setup** > **Backup and Restore**.
2. Select **New Backup**.
3. Enter a name for the backup file and select **Backup**.

## Downloading a backup file

A disaster recovery plan can include exporting backup files to another location.

1. In the left navigation menu, select **Service Setup** > **Backup and Restore**.
2. If using the web user interface (UI), select a backup file and select **Download**.  
The file automatically downloads to the computer's Downloads folder.
3. If using the touch panel control, insert a USB flash drive into the **USB** port on the projector faceplate.
4. Select a backup file and select **Download**.
5. Select  to move up through the file directory.
6. In the Name field, enter a name for the backup file.
7. Select **Accept**.

## Importing a backup file

Import a backup file to restore projector settings.

1. In the left navigation menu, select **Service Setup** > **Backup and Restore**.
2. If using the touch panel control, insert a USB flash drive into the **USB** port on the projector faceplate.
3. Select **Import Backup**.
4. Browse to the location of the file or enter a name for the backup file in the Name field.
5. Select the file and select **Open**.

6. If the file already exists, in the confirmation dialog select **Overwrite**.

## Sorting backup files by name and date created

Locate a backup file with a specific name or creation date.

1. In the left navigation menu, select **Service Setup > Backup and Restore**.
2. Sort the backup files:
  - To sort the backup files by name, select the **Backup File Name** heading.
  - To sort the files by the date they were created, select the **Date Created** heading.

## Deleting a backup file

Delete a backup file if it is no longer required or is uploaded in error.

1. In the left navigation menu, select **Service Setup > Backup and Restore**.
2. Select a backup file and select **Delete** .
3. To confirm, select **Delete**.

## Restoring settings from a backup file

Restore projector settings from a backup file.

1. In the left navigation menu, select **Service Setup > Backup and Restore**.
2. Select a backup file and select **Restore**.
3. Select the settings you want to restore and select **Restore**.
4. When the restore is complete, select **OK**.

## Restoring factory default settings

Restoring factory settings removes all custom projector settings.

1. In the left navigation menu, select **Service Setup > Backup and Restore**.
2. Select **Factory Restore**.
3. Select the settings you want to restore and select **Restore**.
4. Select **OK**.

## Upgrading the projector software

An upgrade package is used to upgrade the projector software to the latest version. The upgrade package is installed from a USB key, the projector's `ftpuser` directory, or from your computer.

To obtain the upgrade package, contact Christie Technical support. Christie recommends backing up your files before installing an upgrade package.

1. Power on the projector and place it in Standby mode.
2. Upload the required upgrade package using one of the following methods:
  - Using the touch panel—Upload the required upgrade package to a USB key or navigate to the projector's `ftpuser` directory.



NTFS-formatted USB drives are not supported for this release.

- Using the web user interface (UI)—Upload the required upgrade package to your computer.
3. If using the USB method, insert the USB key into the projector.
  4. In the left navigation menu, select **Service Setup > System Upgrade**.  
The available upgrade packages are displayed on screen.
  5. If you uploaded the upgrade package to your computer, select **+ New Upgrade File**.
  6. Select the upgrade package file from the list.
  7. Select **Open**.
  8. In the right pane, navigate to the upgrade file and select **Upgrade**.
  9. To begin the upgrade, select **Upgrade** in the confirmation dialog.  
The projector restarts automatically when the upgrade is complete.

# Accessing projector diagnostics

Learn how to access projector system logs and run diagnostic utilities.

## Retrieving and downloading system logs

System logs can aid with the identification and correction of projector faults.

1. In the left navigation menu, select **Diagnostics > System Logs/Interrogator**.
2. In the From list, select a start date for the logs.
3. In the To list, select an end date for the logs.
4. Select **Search Logs**.
5. To sort log files by type, message, or date, select a column heading.

## Running the projector interrogator

Run the interrogator to identify and correct projector faults.

1. If using the touch panel control, insert a USB flash drive into the **USB** port on the projector faceplate.
2. In the left navigation menu, select **Diagnostics > System Logs/Interrogator**.
3. Select **Run Interrogator**.
4. In the confirmation dialog, select **Interrogate**.

By default, the interrogator excludes the following to limit the size of the log file output:

- Warp files
- Light source data (for warranty purposes)
- Cinema sensor files beyond the 5 most recent
- Core snapshots beyond the 5 most recent
- Test patterns

To include the above files in the interrogator log, select the option for **Enhanced**. Including these files significantly increases the size of the interrogator log file (ZIP).

5. If using the web user interface, in the Interrogator dialog, select **Download File**.
6. If using the touch panel control, browse to the location where you want the interrogator file to be saved.
7. In the Name field, enter a name for the interrogator file.
8. Select **Accept**.



## Viewing laser diagnostic information

Find diagnostic information on the light source.

1. In the left navigation menu, select **Laser Settings > Laser Diagnostics**.
2. Review the detailed information for the following:
  - Model
  - Version
  - Serial numbers
  - Power health
  - Drivers
  - Temperature

## Downloading a certificate

Follow these steps to download a required certificate.

1. If using the touch panel control, insert a USB flash drive into the **USB** port on the projector faceplate.
2. In the left navigation menu, select **About**.
3. Select a certificate type.
4. Select **Download**.  
If using the web user interface, the certificate automatically downloads to your computer's Downloads folder.
5. If using the touch panel control, browse to the location where you want to save the certificate.
6. Select **Accept**.

# Regulatory

This product conforms to the latest regulations and standards related to product safety, environmental, and electromagnetic compatibility (EMC) requirements.

## Safety

- IEC 62368-1:2018 - Audio/Video, Information And Communication Technology Equipment - Part 1: Safety Requirements
- BS EN 62368-1:2014 - Audio/Video, Information And Communication Technology Equipment - Part 1: Safety Requirements
- UL 62368-1:2018 - Audio/Video, Information And Communication Technology Equipment - Part 1: Safety Requirements
- CSA CAN/CSA-22.2 No. 62368-1:2018 - Audio/Video, Information And Communication Technology Equipment - Part 1: Safety Requirements
- IEC 62471-5:2015 – Photobiological Safety of Lamps and Lamp Systems – Part 5: Image projectors
- IEC 60825-1:2014 - Safety of Laser Products - Part 1: Equipment Classification and Requirements
- ANSI Z136.1 (2014) – Safety of Lasers

## Electro-magnetic compatibility

### Emissions

- CAN ICES-003 (A)/NMB-003 (A) – Information Technology Equipment (Including Digital Apparatus) – Limits and Methods of Measurement
- CISPR 32/EN 55032, Class A – Electromagnetic Compatibility of Multimedia Equipment – Emission Requirements
- FCC CFR47, Part 15, Subpart B, Class A – Unintentional Radiators
- IEC 61000-3-2/EN61000-3-2: Limits for harmonic current emissions for equipment with input current  $\leq 16$  A
- IEC 61000-3-3/EN 61000-3-3: Limitations of Voltage Changes, Voltage Fluctuations, and Flicker input current  $\leq 16$  A per phase and not subject to conditional connection

### Immunity

- CISPR 35/EN 55035 Electromagnetic compatibility of multimedia equipment - Immunity requirements

## California law on security

- California Law Requiring Internet Connected Devices To Include Reasonable Security Features (California Civil Code Section 1798.91.04)

## Environmental

- China Ministry of Information Industry (along with 7 other Government Agencies) Order No.32 (01/2016) on the control of pollution caused by electronic information products, hazardous substances concentration limits (GB/T 26572 - 2011), and the applicable product marking requirement (SJ/T 11364 - 2014).
- EU Directive (2011/65/EU) on the restriction of the uses of certain hazardous substances (RoHS) in electrical and electronic equipment and the applicable official amendment(s).
- EU Directive (2012/19/EU) on waste and electrical and electronic equipment (WEEE) and the applicable official amendment(s).
- Regulation (EC) No. 1907/2006 on the registration, evaluation, authorization and restriction of chemicals (REACH) and the applicable official amendment(s).

International packaging recycling mark requirements.

- EU Directive (2012/19/EU) on waste and electrical and electronic equipment (WEEE) and the applicable official amendment(s).
- EU Directive (94/62/EC) on packaging and packaging waste
- China packaging recycling mark standard (GB18455-2010)