

The top half of the page features a complex, abstract background of overlapping, semi-transparent blue polygons in various shades, creating a dynamic, crystalline effect. This pattern transitions into a clean white background at the bottom.

User Manual  
020-001919-03

# Christie Captiva Series

## DWU500S

**CHRISTIE®**

## NOTICES

### COPYRIGHT AND TRADEMARKS

Copyright ©2024 Christie Digital Systems USA Inc. All rights reserved.

All brand names and product names are trademarks, registered trademarks or trade names of their respective holders.

### GENERAL

Every effort has been made to ensure accuracy, however in some cases changes in the products or availability could occur which may not be reflected in this document. Christie reserves the right to make changes to specifications at any time without notice. Performance specifications are typical, but may vary depending on conditions beyond Christie's control such as maintenance of the product in proper working conditions. Performance specifications are based on information available at the time of printing. Christie makes no warranty of any kind with regard to this material, including, but not limited to, implied warranties of fitness for a particular purpose. Christie will not be liable for errors contained herein or for incidental or consequential damages in connection with the performance or use of this material. Canadian manufacturing facility is ISO 9001 and 14001 certified.

### WARRANTY

Products are warranted under Christie's standard limited warranty, the details of which are available at <https://www.christiedigital.com/help-center/warranties/> or by contacting your Christie dealer or Christie.

### PREVENTATIVE MAINTENANCE

Preventative maintenance is an important part of the continued and proper operation of your product. Failure to perform maintenance as required, and in accordance with the maintenance schedule specified by Christie, will void the warranty.

### REGULATORY

The product has been tested and found to comply with the limits for a Class A digital device, pursuant to Part 15 of the FCC Rules. These limits are designed to provide reasonable protection against harmful interference when the product is operated in a commercial environment. The product generates, uses, and can radiate radio frequency energy and, if not installed and used in accordance with the instruction manual, may cause harmful interference to radio communications. Operation of the product in a residential area is likely to cause harmful interference in which case the user will be required to correct the interference at the user's own expense. Changes or modifications not expressly approved by the party responsible for compliance could void the user's authority to operate the equipment.

### CAN ICES-3 (A)/NMB-3 (A)

이 기기는 업무용 (A 급) 으로 전자파적합등록을 한 기기이오니 판매자 또는 사용자는 이점을 주의하시기 바라며, 가정 외의 지역에서 사용하는 것을 목적으로 합니다.

### ENVIRONMENTAL



The product is designed and manufactured with high-quality materials and components that can be recycled and reused. This  symbol means

electrical and electronic equipment, at their end-of-life, should be disposed of separately from regular waste. Please dispose of the product appropriately and according to local regulations. In the European Union, separate collection systems are for used electrical and electronic products.

If printing this document, consider printing only the pages you need and select the double-sided option.

Please help us to conserve the environment we live in!

### Notation

Learn the hazard and information symbols used in the product documentation.



Danger messages indicate a hazardous situation which, if not avoided, results in death or serious injury.



Warning messages indicate a hazardous situation which, if not avoided, could result in death or serious injury.



Caution messages indicate a hazardous situation which, if not avoided, could result in minor or moderate injury.



Notice messages indicate a hazardous situation which, if not avoided, may result in equipment or property damage.



Information messages provide additional information, emphasize or provide a useful tip.

# Content

<b>Introduction .....</b>	<b>5</b>
Safety and warning guidelines .....	5
AC/power precautions .....	6
Installation safety and warning guidelines .....	6
Laser safety precautions .....	6
Product labels .....	7
Projector components .....	9
Front view .....	9
Top view .....	10
Rear view .....	10
Left view .....	11
Right view .....	11
Built-in keypad .....	12
Input/Output (I/O) panel .....	13
IR remote keypad .....	14
LED status indicators .....	16
Product documentation .....	17
Related documentation .....	17
Technical support .....	17
<b>Installation .....</b>	<b>18</b>
Connecting to a computer .....	18
Connecting to video equipment .....	19
Powering the projector on/off .....	20
Powering on the projector .....	20
Powering the projector off .....	21
Adjusting the projector position .....	22
Installing the ceiling mount .....	23
<b>Operation .....</b>	<b>24</b>
Picture menu .....	25
Screen menu .....	27
Geometry Correction .....	29
Settings Menu .....	30
Volume menu .....	32

Options Menu . . . . .	33
SSI Settings . . . . .	35
3D menu . . . . .	36
LAN menu . . . . .	37
Using web user interface . . . . .	39
System requirements . . . . .	39
Logging on to the web user interface . . . . .	39
<b>Troubleshooting . . . . .</b>	<b>41</b>
No image appears on screen . . . . .	41
Incorrectly displayed image . . . . .	41
Presentation is not displayed . . . . .	42
Unstable or flickering images . . . . .	43
Vertical flickering bar . . . . .	43
Image is out of focus . . . . .	43
Image is stretched . . . . .	43
Image is not the correct size . . . . .	44
Connection fail when DHCP on . . . . .	44
Connection fail with new IP address . . . . .	45
<b>Specifications . . . . .</b>	<b>46</b>
Inputs . . . . .	46
Key features . . . . .	49
List of components . . . . .	50
Physical specifications . . . . .	50
Physical operating environment . . . . .	51
Power requirements . . . . .	51
Regulatory . . . . .	52
Safety . . . . .	52
Laser Safety . . . . .	52
Electro-Magnetic Compatibility . . . . .	52
Environmental . . . . .	52
Marking . . . . .	53
Federal Communications Commission (FCC) warning . . . . .	53
Notice: Canadian users . . . . .	53
Remarque à l'intention des utilisateurs canadiens . . . . .	53
Declaration of Conformity for EU countries . . . . .	53
CE Notice . . . . .	54
On-screen display tree . . . . .	55

# Introduction

This manual is intended for Christie qualified installers and trained operators of DWU500S projection systems.

For complete DWU500S product documentation and technical support, go to [www.christiedigital.com](http://www.christiedigital.com).

## Safety and warning guidelines

This projector must be operated in an environment that meets the operating range specification. Use only the attachments and/or accessories recommended by Christie. Use of others may result in the risk of fire, shock, or personal injury.



**Warning!** If not avoided, the following could result in death or serious injury.

- Do not expose the product to moisture.
- Do not operate the product without all of its covers in place.
- FIRE HAZARD! Keep hands, clothes, and all combustible material away from the concentrated light beam of the projector.
- TRIP OR FIRE HAZARD! Position all cables where they cannot contact hot surfaces, be pulled, be tripped over, or damaged by persons walking on or objects rolling over the cables.
- SHOCK HAZARD! Disconnect the product from AC before installing, moving, servicing, cleaning, removing components, or opening any enclosure.
- OPTICAL RADIATION HAZARD! Disconnect the power plug from the AC outlet if the product is not being used for an extended period of time.
- Do not allow anything to rest on the power cord.
- Always provide proper ventilation for the product to prevent overheating.



**Caution!** If not avoided, the following could result in minor or moderate injury.

- Only Christie qualified technicians are permitted to open product enclosures.
- All procedures must be performed by Christie qualified technicians.



**Notice.** If not avoided, the following may result in equipment or property damage.

- Always use a lens plug when installing or moving the product. This prevents contaminants from entering the product.
- Only use cleaning solutions recommended by Christie. All other cleaning solutions may cause product damage and will void the warranty.

## AC/power precautions

Read all safety and warning guidelines before powering on the projector.



**Warning!** If not avoided, the following could result in death or serious injury.

- FIRE HAZARD! Do not use a power cord, harness, or cable that appears damaged.
- FIRE OR SHOCK HAZARD! Do not overload power outlets and extension cords.
- SHOCK HAZARD! Only use the AC power cord provided with the product or recommended by Christie.
- FIRE AND SHOCK HAZARD! Do not attempt operation unless the power cord, power socket, and power plug meet the appropriate local rating standards.
- SHOCK HAZARD! Do not attempt operation if the AC supply is not within the specified voltage and current, as specified on the license label.
- SHOCK HAZARD! The AC power cord must be inserted into an outlet with grounding.
- SHOCK HAZARD! Disconnect the product from AC before installing, moving, servicing, cleaning, removing components, or opening any enclosure.
- Install the product near an easily accessible AC receptacle.

## Installation safety and warning guidelines

Read all safety and warning guidelines before installing the projector.



**Warning!** If not avoided, the following could result in death or serious injury.

- High leakage current present when connected to IT power systems.



**Caution!** If not avoided, the following could result in minor or moderate injury.

- ELECTRICAL and BURN HAZARD! Use caution when accessing internal components.
- Only Christie qualified technicians are authorized to use the tools provided in the toolbox.

## Laser safety precautions

This product is classified as Class 1 Laser Product-Risk Group 2 according to IEC 60825-1:2014 complies with 21 CFR 1040.10 and 1040.11 except for conformance as a Risk Group 2 LIP as defined in IEC 62471-5:Ed. 1.0. For more information see Laser Notice No. 57, dated May 8, 2019.



**Warning!** If not avoided, the following could result in death or serious injury.













- This projector has a built-in Class 4 laser module. Never attempt to disassemble or modify the projector.
- Any operation or adjustment not specifically instructed in the User manual creates the risk of hazardous laser radiation exposure.
- Do not open or disassemble the projector as this may cause damage or exposure to laser radiation.
- Do not stare into beam when the projector is on. The bright light may result in permanent eye damage.
- When turning on the projector, make sure no one within projection range is looking into the lens.
- Follow the control, adjustment, or operation procedures to avoid damage or injury from exposure of laser radiation.
- The instructions for the assembly, operation, and maintenance include clear warnings concerning precautions to avoid possible exposure to hazardous laser radiation.

## Product labels

Learn about the labels that may be used on the product. Labels on your product may be yellow or black and white.

### General hazards

Hazard warnings also apply to accessories once they are installed in a Christie product that is connected to power.

Fire and Shock Hazard	
 	<p>To prevent fire or shock hazards, do not expose this product to rain or moisture.</p> <p>Do not alter the power plug, overload the power outlet, or use it with extension Cords.</p> <p>Do not remove the product enclosure.</p> <p>Only Christie qualified technicians are authorized to service the product.</p>
Electrical Hazard	
	<p>Risk of electric shock.</p> <p>Do not remove the product enclosure.</p> <p>Only Christie qualified technicians are authorized to service the product.</p>
	<p>General hazard.</p>
	<p>Electric shock hazard. To avoid personal injury, disconnect all power sources before performing maintenance or service.</p>
	<p>Electrocution hazard. To avoid personal injury, always disconnect all power sources before performing maintenance or service procedures.</p>
	<p>Fire hazard. To avoid personal injury and property damage, follow the instructions provided in this document.</p>
	<p>Hot surface hazard. To avoid personal injury, allow the product to cool for the recommended cool down time before performing maintenance or service.</p>
	<p>Burn hazard. To avoid personal injury, allow the product to cool for the recommended cool down time before performing maintenance or service.</p>
	<p>Moving parts hazard. To avoid personal injury, keep hands clear and loose clothing tied back.</p>
	<p>Fan hazard. To avoid personal injury, keep hands clear and loose clothing tied back. Always disconnect all power sources before performing maintenance or service procedures.</p>
	<p>Voltage hazard. To avoid personal injury, always disconnect all power sources before performing maintenance or service procedures.</p>
	<p>Not for household use.</p>

### Mandatory action



Consult the service manual.



Disconnect all power sources before performing maintenance or service procedures.

### Electrical labels



Indicates the presence of an earth ground.

### Laser labels

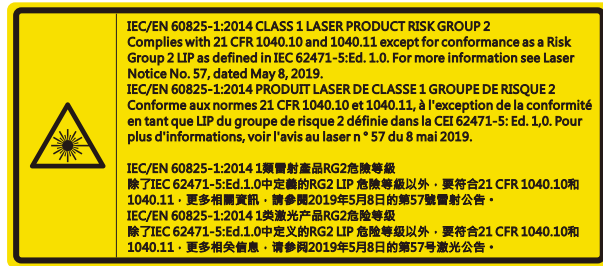

This projector has been classified as Class 1 Laser Product-Risk Group 2 according to the IEC 60825-1:2014 and IEC 62471-5:2015 standard.

Indicates a light hazard. Do not look directly into the lens. The extreme high brightness can cause permanent eye damage. Class 1 Laser Product-Risk Group 2 according to Class 1 IEC 60825-1:2014 and IEC 62471-5:2015.



Do not look directly into the lens. The extremely high brightness can cause permanent eye damage.



Do not mount above the heads of children. When within 1 m of the product, avoid eye exposure to avoid temporary or permanent eye damage.



## Projector components

Identify the main components of the projector.

### Front view

Identify the main components on the front of the projector.

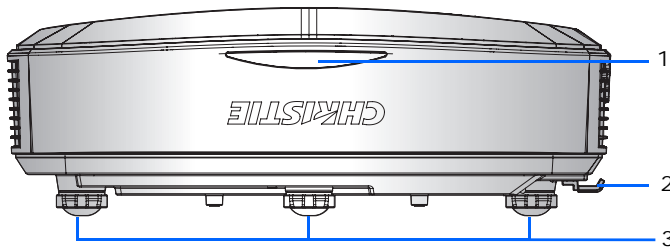

ID	Part name	Description
1	Front IR sensor	Receives signals from the IR remote keypad. Keep the signal path to the sensor unobstructed for uninterrupted communication with the projector.
2	Focus switch	Adjusts the focus.
3	Adjustable feet	Raises or lowers the feet to level the projector.

## Top view

Identify the main components on the top of the projector.

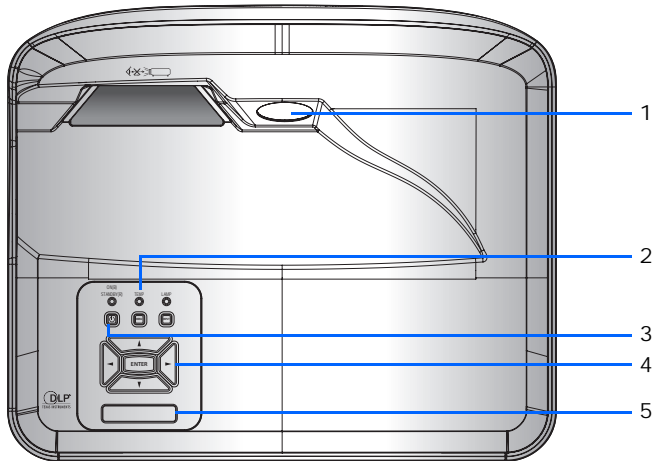

ID	Part name	Description
1	Projection lens	Fixed lens
2	LED Status Indicators	Displays the status of the projector.
3	Power button	Turns the projector on or off.
4	Built-in keypad	Controls the projector.
5	Top IR sensor	Receives signals from the IR remote keypad. Keep the signal path to the sensor unobstructed for uninterrupted communication with the projector.

## Rear view

Identify the main components on the rear of the projector.

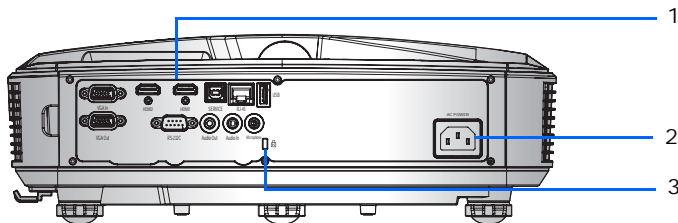

ID	Part name	Description
1	Input/Output (I/O) panel	Connects the projector to external devices.
2	AC input	Connects to the supplied power adapter (100-240V).

ID	Part name	Description
3	Kensington Security Slot	Secures the projector to help prevent theft or unauthorized removal.

## Left view

Identify the main components on the left side of the projector.

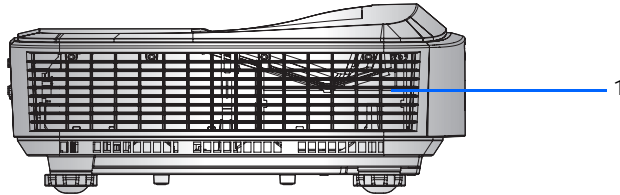

ID	Part name	Description
1	Cooling air vents (intake)	Provides cooling to the projector. Keep these vents unobstructed to prevent the projector from overheating.

## Right view

Identify the main component on the right side of the projector.

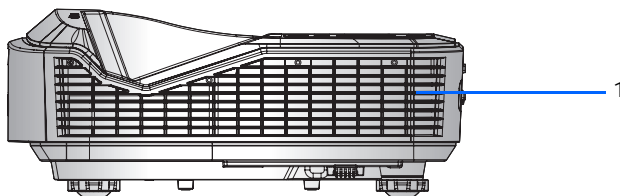

ID	Part name	Description
1	Cooling air vents (exhaust)	Provides cooling to the projector. Keep these vents unobstructed to prevent the projector from overheating.

## Built-in keypad

The built-in keypad controls the projector.

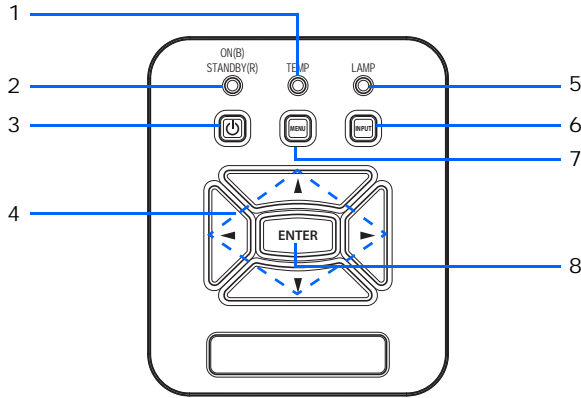

ID	Part name	Description
1	Temp LED	Indicates the projector temperature status.
2	Power LED	Indicates the projector power status.
3	Power	Turns the projector on or off.
4	Arrow keys	Selects an item or makes the adjustment to your selection.
5	Lamp LED	Indicates the projector light source status.
6	Input	Selects an input signal.
7	Menu	Displays the on-screen display (OSD) menu.
8	Enter	Confirms your item selection.

# Input/Output (I/O) panel

Identify the components of the Input/Output (I/O) panel.

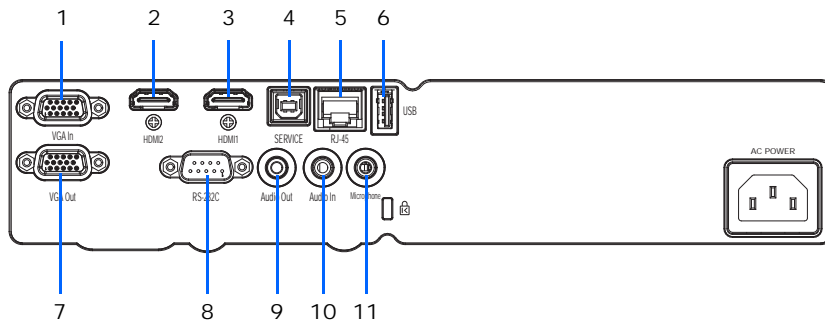

ID	Connector name	ID	Connector name
1	VGA In	7	VGA Out
2	HDMI2	8	RS-232C
3	HDMI1	9	Audio Out
4	SERVICE (USB Type B)	10	Audio In
5	RJ-45	11	Microphone
6	USB Type A		

# IR remote keypad

The IR remote keypad communicates with the projector by way of wireless communications.

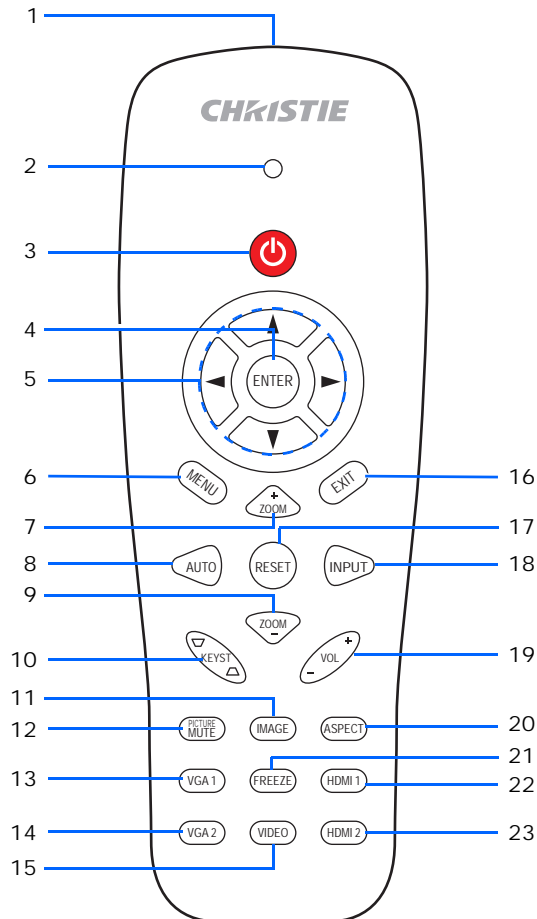

ID	Button	Description
1	Infrared transmitter	Sends signals to the projector.
2	LED	LED Indicator
3	Power	Turns the projector on.
4	ENTER	Confirms your item selection.
5	Arrow keys	Selects an item or makes the adjustment to your selection.
6	MENU	Displays the on-screen display (OSD) menu.
7	ZOOM +	Zooms in the projector display.
8	AUTO	Automatically synchronizes the projector to the input source.

<b>ID</b>	<b>Button</b>	<b>Description</b>
9	ZOOM -	Zooms out the projector display.
10	KEYST +/-	Adjusts the image distortion caused by tilting the projector.
11	IMAGE	Selects the color mode from Bright, Presentation, Movie, Game, and User.
12	PICTURE MUTE	Momentarily turns off/on the audio and video.
13	VGA1	Press this button to choose VGA In connector.
14	VGA2	No function
15	VIDEO	Selects the Composite video source.
16	EXIT	Closes the OSD menu.
17	RESET	Returns the adjustments and settings to the factory default values.
18	INPUT	Selects an input signal.
19	VOL +/-	Adjusts the volume.
20	ASPECT	Selects your required aspect ratio.
21	FREEZE	Pauses the screen image. Press it again to resume the screen image.
22	HDMI1	Selects the HDMI1 connector.
23	HDMI2	Selects the HDMI2 connector.

## LED status indicators

LEDs are defined below.

<b>Projector state</b>	<b>Power LED (Blue)</b>	<b>Power LED (Red)</b>	<b>TEMP LED (Red)</b>	<b>LAMP LED (Red)</b>
Standby	N/A	Solid	N/A	N/A
Warming Up	N/A	Flashing (1s/1s)	N/A	N/A
Power On	Solid	N/A	N/A	N/A
Cooling	N/A	Flashing (0.5s/0.5s)	N/A	N/A
Burn-In On	Flashing (1s/1s)	Flashing (1s/1s)	N/A	N/A
Burn-In Off	Flashing (1s/1s)	Flashing (1s/1s)	N/A	N/A
Scalar Download mode	Solid	Solid	Solid	Solid
POWERGOOD NG	N/A	N/A	Solid	Solid
Overheat	N/A	N/A	Solid	N/A
LD Overheat	N/A	N/A	Solid	N/A



## Product documentation

For installation, setup, and user information, see the product documentation available on the Christie Digital Systems USA Inc. website at [www.christiedigital.com](http://www.christiedigital.com). Read all instructions before using or servicing this product.

1. Access the documentation from the Christie website:

- Go to this URL: <https://bit.ly/2Sjn7Ld> or <https://www.christiedigital.com/products/projectors/all-projectors/captivadwu500s>
- Scan the QR code using a QR code reader app on a smartphone or tablet.



2. On the product page, select the model and switch to the **Downloads** tab.

## Related documentation

Additional information on the projector is available in the following documents.

- Christie-LIT-MAN-SAFETY GUIDE-Captiva-DWU500S (P/N: 020-001938-XX)
- Christie-LIT-MAN-SERV-Captiva-DWU500S (P/N: 020-001920-XX)
- Christie-LIT-GUID-TECH-Captiva-DWU500S-API (P/N: 020-103535-XX)

## Technical support

Technical support for Christie Enterprise products is available at:

- North and South America: +1-800-221-8025 or [Support.Americas@christiedigital.com](mailto:Support.Americas@christiedigital.com)
- Europe, Middle East, and Africa: +44 (0) 1189 778111 or [Support.EMEA@christiedigital.com](mailto:Support.EMEA@christiedigital.com)
- Asia Pacific ([support.apac@christiedigital.com](mailto:support.apac@christiedigital.com)):
  - Australia: +61 (0)7 3624 4888 or [tech-Australia@christiedigital.com](mailto:tech-Australia@christiedigital.com)
  - China: +86 10 6561 0240 or [tech-supportChina@christiedigital.com](mailto:tech-supportChina@christiedigital.com)
  - India: +91 (80) 6708 9999 or [tech-India@christiedigital.com](mailto:tech-India@christiedigital.com)
  - Japan: 81-3-3599-7481
  - Singapore: +65 6877-8737 or [tech-Singapore@christiedigital.com](mailto:tech-Singapore@christiedigital.com)
  - South Korea: +82 2 702 1601 or [tech-Korea@christiedigital.com](mailto:tech-Korea@christiedigital.com)
- Christie Professional Services: +1-800-550-3061 or [NOC@christiedigital.com](mailto:NOC@christiedigital.com)

# Installation

Learn how to install, connect, and optimize the projector display.

## Connecting to a computer

Learn what cables/connectors that may be used to connect to various devices.

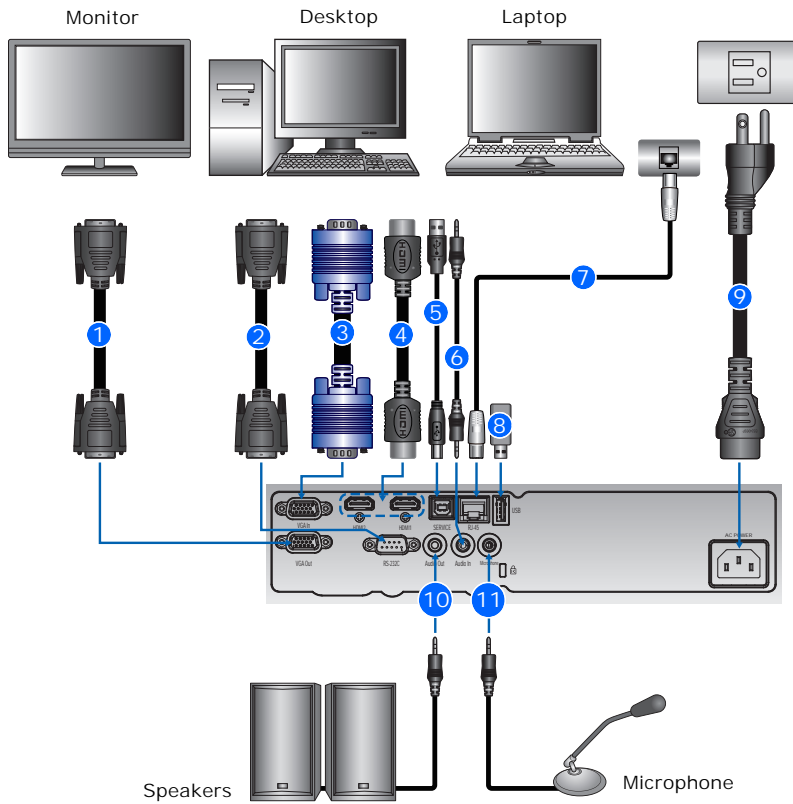

ID	Connector name	ID	Connector name	ID	Connector name
1	VGA out cable	5	USB cable	9	Power cord
2	RS-232 cable	6	Audio input cable	10	Audio output cable
3	VGA in cable	7	RJ45 cable	11	Microphone cable
4	HDMI cable	8	USB disk drive		



- Due to the difference in applications for each country, the accessories required in some regions may differ from those shown.
- This diagram is for illustrative purposes only and does not indicate the accessories supplied with the projector.

## Connecting to video equipment

Learn what cable/connectors may be used to connect to various devices.

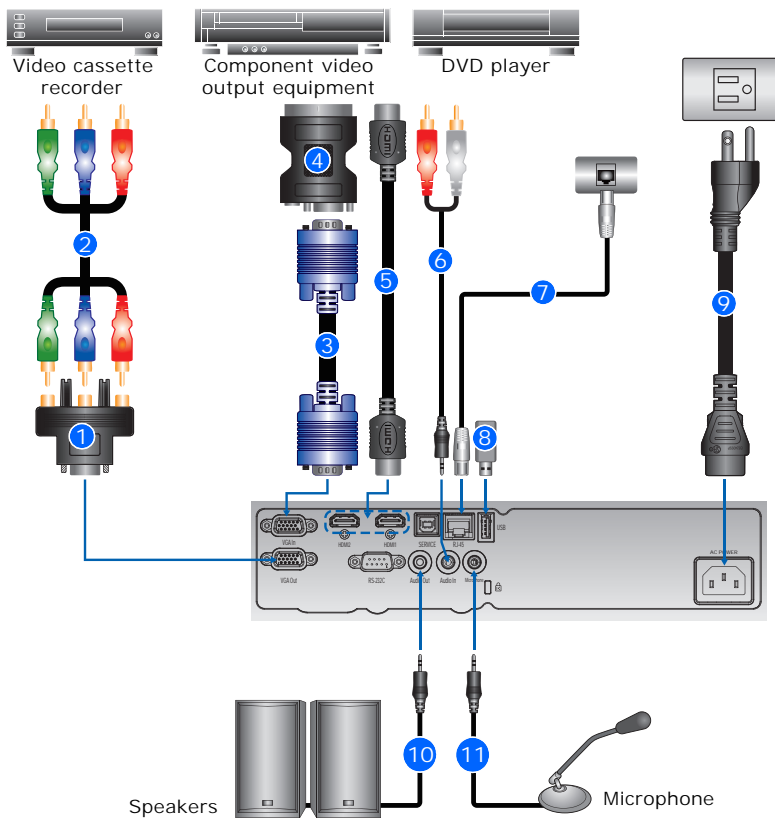

ID	Connector name	ID	Connector name	ID	Connector name
1	15-pin to 3 RCA Component/HDTV Adapter	5	HDMI cable	9	Power cord
2	3 RCA Component cable	6	Audio input cable	10	Audio output cable
3	VGA in cable	7	RJ45 cable	11	Microphone cable
4	VGA to Component	8	USB disk drive		



- Due to the difference in applications for each country, the accessories required in some regions may differ from those shown.
- This diagram is for illustrative purposes only and does not indicate the accessories supplied with the projector.

## Powering the projector on/off

Learn how to turn on or off the projector.

### Powering on the projector

To turn on the projector, do the following:

1. Securely connect the power cord and signal cable.

When connected, the Power LED turns red.

2. Turn on the projector by pressing the  button either on the built-in keypad or on the IR remote keypad.

The Power LED turns blue. The startup screen displays in approximately five seconds.

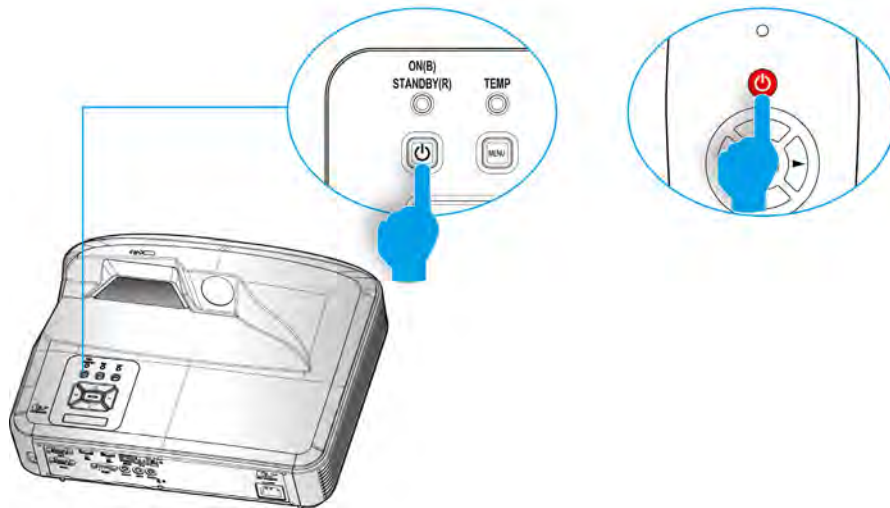

3. The first time you use the projector, you are asked to select the preferred language and power saving mode.
4. Turn on and connect the source you want to display on the screen (computer, notebook, video player, and so on).



The projector detects the source automatically. If not, press **MENU** and go to **Options**.



- If connecting multiple sources at the same time, press **INPUT** on the built-in keypad or direct source keys on the IR remote keypad to switch between inputs.
- When the power mode is in Standby mode (power consumption < 0.5W), the VGA output/input and audio are deactivated when the projector is in standby.

## Powering the projector off

To turn off the projector, do the following:

1. Press the  button either on the built-in keypad or on the IR remote keypad to turn off the projector.
2. At the confirmation prompt, press the  button again.

Otherwise, the message disappears after 10 seconds. When pressing the  button for the second time, the fan starts cooling the system and the projector shuts down. The cooling fans continue to operate for approximately four seconds for the cooling cycle and the Power LED flashes red.

When the Power LED is solid red, the projector has entered Standby mode.

To turn the projector back on, you must wait until the projector has completed the cooling cycle and has entered Standby mode. Once in Standby mode, press the  button to restart the projector.

3. Disconnect the power cord from the electrical outlet and the projector.

## Adjusting the projector position

When selecting a position for the projector, consider the size and shape of your screen, the location of your power outlets, and the distance between the projector and the rest of your equipment. Follow these general guidelines:

**Case A**

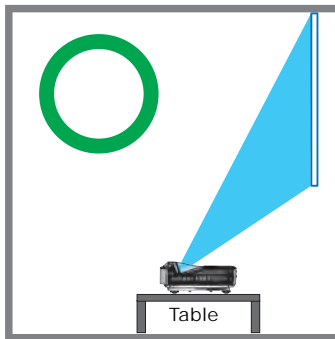

**Table Top Projection**

**Case B**

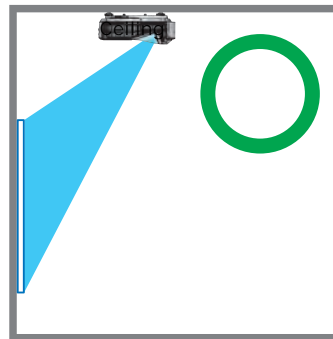

**Ceiling Mount Projection**

**Case C**

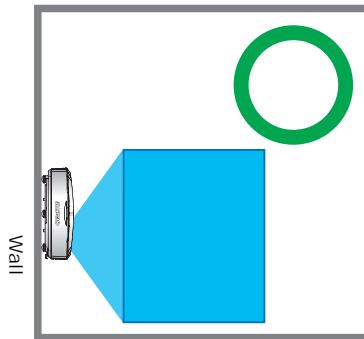

**Portrait Projection (Left)**

**Case D**

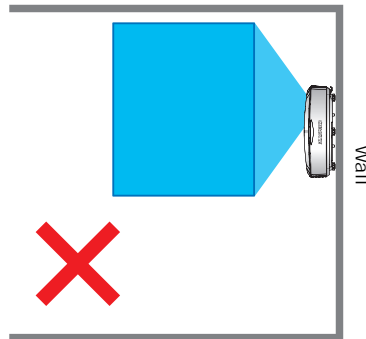

**Portrait Projection (Right)**

**Case E**

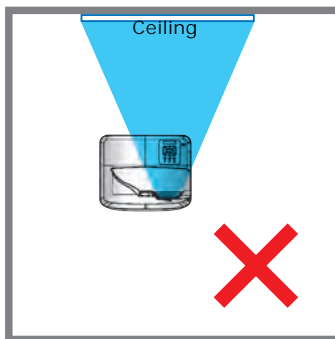

**Upward Projection**

**Case F**

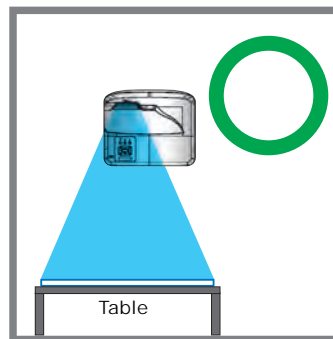

**Downward Projection**

## Installing the ceiling mount

Mount the projector with a Christie-approved mount, using the four mounting points on the underside of the projector.

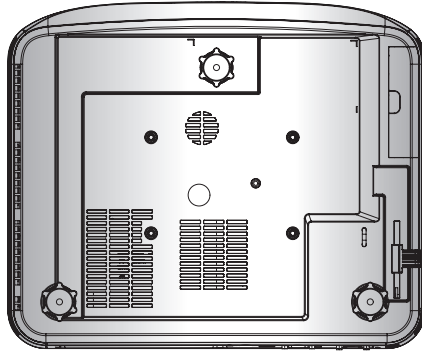

Refer to the installation instructions and safety guidelines provided in the kit. See [List of components](#) on page 50.

# Operation

The projector has multilingual on-screen display (OSD) menus so you can make image adjustments and change a variety of settings.

Most of the projector controls are accessed from within the projector menu system. Several groups of related functions are selectable from the Main menu as shown below.

1. To display the Main menu, on the IR remote keypad or on the built-in keypad, press **MENU**.
2. To navigate within the menu and adjust a setting up or down, use the arrow keys.
3. To select a highlighted menu item or use it to change or accept a value, press **ENTER**.

You can then select the next item to adjust in the menu and adjust it.

4. To exit menus if at top level, press **EXIT**.



## Picture menu

The Picture menu sets the color mode, wall color, and other settings for images.

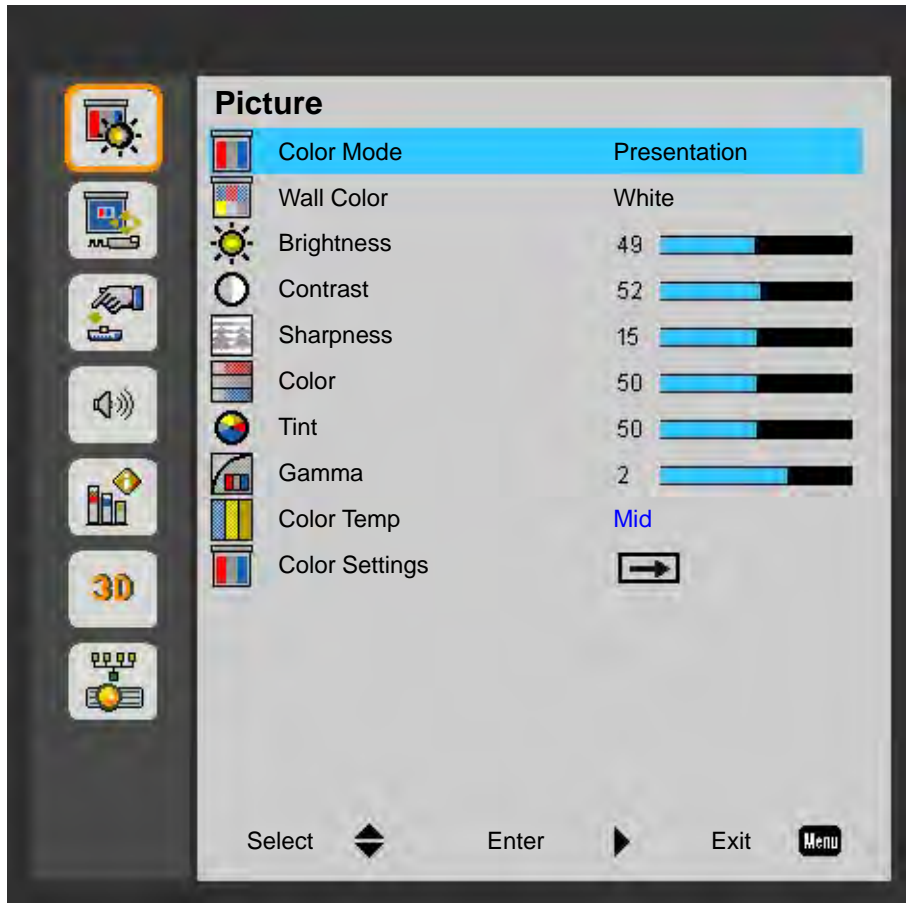

Menu item	Description	Options
Color Mode	Optimizes the projector for displaying images under certain conditions.	<ul style="list-style-type: none"> <li>• Bright</li> <li>• Presentation</li> <li>• Movie</li> <li>• Game</li> <li>• User</li> </ul>
Wall Color	Sets the wall color so that the projector can enhance the color performance customized for the specific wall.	<ul style="list-style-type: none"> <li>• White</li> <li>• Light Yellow</li> <li>• Light Blue</li> <li>• Pink</li> <li>• Dark Green</li> </ul>
Brightness	Adjusts the intensity of the image.	0 to 100

<b>Menu item</b>	<b>Description</b>	<b>Options</b>
Contrast	Adjusts the degree of difference between the lightest and darkest parts of the image and changes the amount of black and white in the image.	0 to 100
Sharpness	Adjusts the sharpness of the image. (VGA component sources only).	0 to 31
Color	Adjusts a video image from black and white to fully saturated color. (VGA component sources only).	0 to 100
Tint	Adjusts the red-green color balance in the image. (VGA component sources only).	0 to 100
Gamma	Adjusts the gamma value to obtain the better image contrast for the input.	0 to 4
Color Temp	Adjusts the color temperature. At higher temperature, the screen looks colder; at lower temperature, the screen looks warmer.	<ul style="list-style-type: none"> <li>• Low</li> <li>• Mid</li> <li>• High</li> </ul>
Color Settings	Use these settings for advanced adjustment of the individual color: <ul style="list-style-type: none"> <li>• Red</li> <li>• Green</li> <li>• Blue</li> <li>• Cyan</li> <li>• Magenta</li> <li>• Yellow</li> <li>• White</li> </ul>	<ul style="list-style-type: none"> <li>• Hue (Red for White)(-99 to 99) (W: 0 to 199)</li> <li>• Saturation (Green for White)(0 to 199)</li> <li>• Gain (Blue for White)(0 to 199)</li> </ul>

## Screen menu

The Screen menu determines the size and position of the image on the screen.



Menu item	Description	Options
Aspect Ratio	Displays an image with the detected size, or resizes the image by maximizing either the height, width, both, or resizes to the maximum size possible while keeping the original aspect ratio.	<ul style="list-style-type: none"> <li>• Auto—Displays with the detected size.</li> <li>• 4:3—Retains 4:3 aspect ratio.</li> <li>• 16:9—Retains 16:9 aspect ratio.</li> <li>• 16:10—Retains 16:10 aspect ratio.</li> </ul>
Phase	Adjust the pixel phase when the image shows shimmer or noise after pixel tracking is optimized. Pixel phase can adjust the phase of the pixel-sampling clock relative to the incoming signal. (Analog RGB signals only.)	Defined by signal

<b>Menu item</b>	<b>Description</b>	<b>Options</b>
Clock	Ensures that the image quality is consistent across the screen, the aspect ratio is maintained, and the pixel phase can be optimized. Steady flickering or several soft vertical stripes or bands across the entire image indicates poor pixel tracking. (Analog RGB signals only).	Defined by signal
H. Position	Moves the image right or left within the area of available pixels.	Defined by signal
V. Position	Moves the image up or down within the area of available pixels.	Defined by signal
Digital Zoom	Reduces or magnifies an image on the projection screen.	0 to 10
Geometry Correction	Adjusts the scaler geometry parameters. For more information on geometry correction, see <a href="#">Geometry Correction</a> on page 29.	<ul style="list-style-type: none"> <li>• V. Keystone—Adjusts the keystone vertically and make a more square image. (0 to 40)</li> <li>• H. Keystone—Adjusts the keystone horizontally and make a more square image. (0 to 40)</li> <li>• 4 Corner On/Off—Enables/disables the 4 Corner adjustment function.</li> <li>• Grid Color—Choose the color of 4 corner, white, green, red, or purple.</li> <li>• 4 Corner Adjust—Allows the image to be squeezed to fit an area defined by moving each of the four corners' x and y position.</li> <li>• 4 Corner Reset—Restore the settings to its default value.</li> </ul>
Orientation	Selects the preferred projection.	<ul style="list-style-type: none"> <li>• Front</li> <li>• Front Ceiling</li> <li>• Rear</li> <li>• Rear Ceiling</li> </ul>
Size	Resizes the projected image with the same scale.	-25,0
Image Shift	Adjusts the projected image position horizontally or vertically.	<ul style="list-style-type: none"> <li>• H. Position (-200 to 200)</li> <li>• V. Position (60 to 60)</li> </ul>

## Geometry Correction

Adjusts the scaler geometry parameters, including horizontal keystone, vertical keystone, and 4-corner adjustments.

### H. Keystone

Adjust the keystone horizontally and make a more square image. Horizontal keystone is used to correct a keystoneed image shape in which the left and right borders of the image are unequal in length, and the top and bottom are slanted to one of the sides. This is intended for use with horizontally on-axis applications.

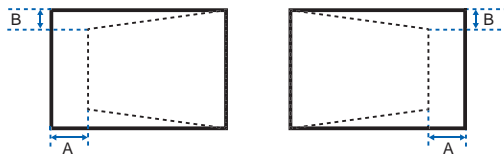

### V. Keystone

Adjust the keystone vertically and make a more square image. Vertical keystone is used to correct a keystoneed image shape in which the left and right borders of the image are unequal in length, and the top and bottom are slanted to one of the sides. This is intended for use with vertically on-axis applications.

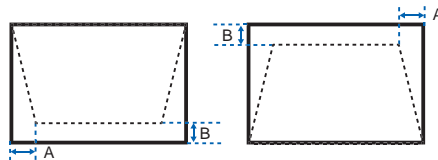

### 4 Corner Adjust

Allow the image to be squeezed to fit an area defined by moving each of the four corners' x and y position.

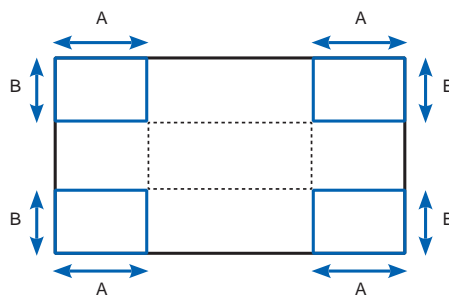

# Settings Menu

The Settings menu sets the language, screen type, menu location, LAN (standby), and other preferences for the projector.



Menu item	Description	Options
Language	Selects an available language for the on-screen display.	<ul style="list-style-type: none"> <li>• English</li> <li>• German</li> <li>• Swedish</li> <li>• French</li> <li>• Arabic</li> <li>• Dutch</li> <li>• Norwegian</li> <li>• Danish</li> <li>• Simplified Chinese</li> <li>• Polish</li> <li>• Korean</li> <li>• Russian</li> <li>• Spanish</li> <li>• Traditional Chinese</li> <li>• Italian</li> <li>• Portuguese</li> <li>• Turkish</li> <li>• Japanese</li> </ul>
Screen Type	Selects the screen type.	<ul style="list-style-type: none"> <li>• 16:9</li> <li>• 16:10</li> </ul>

Menu item	Description	Options
Menu Location	Sets up the on-screen display menu location.	<ul style="list-style-type: none"> <li>• Left Top</li> <li>• Right Top</li> <li>• Center</li> <li>• Left Bottom</li> <li>• Right Bottom</li> </ul>
LAN (Standby)	Enables or disables the LAN connection.	<ul style="list-style-type: none"> <li>• On</li> <li>• Off</li> </ul>
VGA Out (Standby)	Enables or disables the VGA Out connection.	<ul style="list-style-type: none"> <li>• On</li> <li>• Off</li> </ul>
Test Pattern	Displays or hides the test pattern.	<ul style="list-style-type: none"> <li>• On</li> <li>• Off</li> </ul>
Signal Power On	Once enabled, the system will automatically turn the projector on when a signal is detected.	<ul style="list-style-type: none"> <li>• On</li> <li>• Off</li> </ul>
Direct Power On	Once enabled, the system will automatically turn the projector on when the electrical power is connected.	<ul style="list-style-type: none"> <li>• On</li> <li>• Off</li> </ul>
Security	Protects your projector with a password. Once enabled, you must enter the password before you can project an image.	<ul style="list-style-type: none"> <li>• Security—Enables this function to prompt for a password before using the projector.</li> <li>• Security Timer—Sets the number of hours the projector can be used.</li> <li>• Change password—Sets or modifies the password that is prompted when turning the projector on.</li> </ul>
Remote Sensor	Selects the default location of the remote sensor if more than 1 remote sensor.	<ul style="list-style-type: none"> <li>• Front</li> <li>• Top</li> </ul>
Reset	Restores all settings to their default value.	<ul style="list-style-type: none"> <li>• Yes</li> <li>• No</li> </ul>

# Volume menu

The Volume menu configures the volume settings.



Menu item	Description	Options
Output	Sets the audio output.	<ul style="list-style-type: none"> <li>• Speaker</li> <li>• Line Out</li> </ul>
Microphone	Enables or disables the microphone.	<ul style="list-style-type: none"> <li>• On</li> <li>• Off</li> </ul>
Mute	Enables or disables the mute function.	<ul style="list-style-type: none"> <li>• On</li> <li>• Off</li> </ul>
Volume	Adjusts the volume.	0 to 30
Microphone Volume	Adjusts the microphone volume.	0 to 30



# Options Menu

The Options menu allows to select the logo, auto source, HDMI settings, configure auto shutdown parameters, set sleep timer, and configure other options for the projector.



Menu item	Description	Options
Logo	Sets the required startup screen.	<ul style="list-style-type: none"> <li>• Default</li> <li>• User</li> </ul>
Auto Source	Enables this function to let the projector automatically finds an available input source.	<ul style="list-style-type: none"> <li>• On</li> <li>• Off</li> </ul>
HDMI Settings	Configure the HDMI port settings.	<ul style="list-style-type: none"> <li>• HDMI1(1.4/2.0)</li> <li>• HDMI2(1.4/2.0)</li> </ul>
Auto Power Off (Min)	Automatically turns the projector off after no signals are detected for a preset number of minutes. If an active signal is received before the projector powers down, the image is displayed.	0 to 120 mins
Sleep Timer (Min.)	Allows the projector to automatically power off after it has been on for a specified amount of time.	0 to 990 mins

Menu item	Description	Options
SSI Settings	Configure the SSI settings. Refer to <a href="#">SSI Settings</a> on page 35.	—
High Altitude	Enables or disables high altitude mode.	<ul style="list-style-type: none"> <li>• On—Enables high altitude mode for altitudes <math>\geq 2000</math> m. The fan operates at high speed to ensure sufficient air flow for high altitudes.</li> <li>• Off—Disables high altitude mode. For altitudes below 2000m.</li> </ul>
Filters Remind (Hour)	Configures the filters settings.	<ul style="list-style-type: none"> <li>• Filter Reminder—Sets the filter reminder time.</li> <li>• Cleaning up reminder—Selects <b>Yes</b> to reset the dust filter hour counter after replacing or cleaning the dust filter.</li> </ul>
Information	Displays the projector settings. (Read-only)	—
Projector ID	Sets the projector ID.	—

## SSI Settings

Configure the SSI settings.

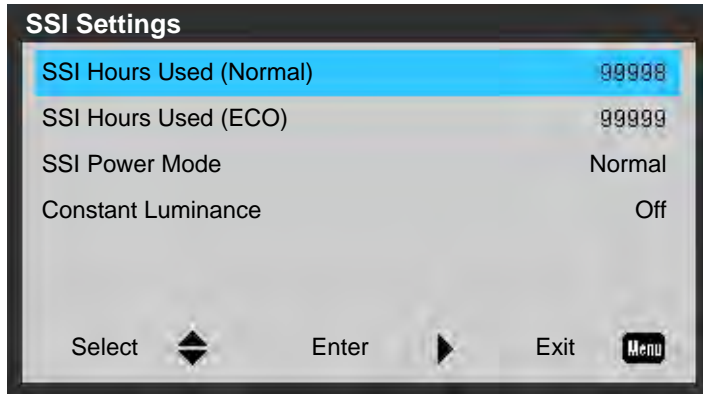

Menu item	Description	Options
SSI Hours Used (Normal)	Displays the projection time of normal mode. (Read-only)	—
SSI Hours Used (ECO)	Displays the projection time of ECO mode. (Read-only)	—
SSI Power Mode	Sets the SSI power mode.	<ul style="list-style-type: none"> <li>• Normal—Normal mode.</li> <li>• ECO—Use this function to dim the projector laser diode which will lower power consumption and extend the laser diode life.</li> </ul>
Constant Luminance	Once enabled, the system will vary the strength of LD luminance such that the brightness maintains consistent with time.	<ul style="list-style-type: none"> <li>• On</li> <li>• Off</li> </ul>

## 3D menu

The 3D menu sets the usage of 3D function and its settings.



Menu item	Description	Options
3D	Enables 3D content detection.	<ul style="list-style-type: none"> <li>• On</li> <li>• Off</li> <li>• Auto</li> </ul>
3D Tech.	Selects 3D technology.	<ul style="list-style-type: none"> <li>• DLP-Link</li> <li>• Off</li> </ul>
3D Invert	Inverts the 3D sync signal when using a single projector.	<ul style="list-style-type: none"> <li>• On</li> <li>• Off</li> </ul>
3D Format	Sets the 3D format. Supports mandatory 3D formats and frame sequential 3D@120Hz.	<ul style="list-style-type: none"> <li>• Frame Packing</li> <li>• Side-by-Side (Half)</li> <li>• Top and Bottom</li> <li>• Frame Sequential</li> <li>• Field Sequential</li> </ul>

Menu item	Description	Options
1080p@24	Sets the 3D resolution 1080p@24 frequency.	<ul style="list-style-type: none"> <li>• 96Hz</li> <li>• 144Hz</li> </ul>

## LAN menu

The LAN menu configure the network parameters for the projector.



Menu item	Description	Options
Status	Displays the network connection status. (Read-only)	—
DHCP	Turns the DHCP on or off.	<ul style="list-style-type: none"> <li>• On</li> <li>• Off</li> </ul>
IP Address	Assigns the network IP address.	—
Subnet Mask	Assigns the network subnet mask.	—

<b>Menu item</b>	<b>Description</b>	<b>Options</b>
Gateway	Assigns the network default gateway.	—
DNS	Assigns the DNS number.	—
Store	Stores the adjusted network configurations.	<ul style="list-style-type: none"> <li>• Yes</li> <li>• No</li> </ul>
MAC Address	Displays the network MAC address value. (Read-only)	—
Group Name	Displays the group name. (Read-only)	—
Projector Name	Displays the projector name. (Read-only)	—
Location	Displays the projector location. (Read-only)	—
Contact	Displays the contact information. (Read-only)	—
Reset	Performs factory reset on the network settings.	<ul style="list-style-type: none"> <li>• Yes</li> <li>• No</li> </ul>

## Using web user interface

The web user interface provides an alternate way to access the menu functionality on the projector. You can log on to the web user interface from a computer or mobile devices.

### System requirements

To use the web user interface, make sure your devices and software meet the minimum system requirements.

Minimum system requirements	
Hardware	<ul style="list-style-type: none"> <li>• Projector</li> <li>• Power cord, provided with the projector and appropriately rated for your region</li> <li>• RJ45 cable (CAT-5e) or wireless dongle</li> <li>• PC, laptop, mobile phone, or tablet installed with a web browser</li> </ul>
Software	<ul style="list-style-type: none"> <li>• Firmware upgrade program</li> <li>• Web browser                             <ul style="list-style-type: none"> <li>• Internet Explorer 11</li> <li>• Microsoft Edge 89.0/90.0/91.0</li> <li>• Firefox 87.0/88.0/89.0</li> <li>• Chrome 81.0/83.0/84.0</li> <li>• Safari 12.0/13.0/14.0</li> </ul> </li> <li>• Operating system of mobile devices                             <ul style="list-style-type: none"> <li>• iOS 10</li> <li>• Android 5</li> </ul> </li> </ul>

### Logging on to the web user interface

Log on to the web user interface by following the steps below.

1. Connect the projector to AC and power it on.
2. When a network is available, connect the projector and computer to the same network.
  - a. To check the projector address in a wired network, press **MENU** and go to **LAN > IP Address**.
  - b. To check the projector address in a wireless network, press **MENU** and go to **LAN > Gateway**.
3. If a network is not available, connect the projector to the computer with an RJ45 cable.
  - a. Set the Gateway and Subnet Mask of the computer to match the projector.
  - b. Set the IP address of the computer to match the first three numbers of the projector.  
 For example, if the projector IP address is 192.168.000.100, set the computer IP address to 192.168.000.xxx, where xxx is not 100.
4. Open a web browser and type the projector address in the browser address bar.

5. In the Username field, type the username.  
The default username is admin.
6. In the Password field, type the password.  
The default password is admin.
7. Click **Login**.



# Troubleshooting

If you cannot resolve an issue using the information provided in this section, contact your reseller or service center.

## No image appears on screen

The image does not appear on the screen.

### Resolution

- Make sure all the cables and power connections are correctly and securely connected. See [Installation](#) on page 18 for more details.
- Make sure the projector is switched on. Check if the Power LED is in Blue.

## Incorrectly displayed image

The image is partial, is scrolling, or is otherwise incorrectly displayed.

### Resolution

If using a PC:

1. On the built-in keypad or the IR remote keypad, press **AUTO**.
2. Select **My Computer > Control Panel**.
3. Double-click **Display**.
4. Select the **Settings** tab.
5. Verify your display resolution setting is lower than or equal to WUXGA (1920 × 1200).
6. Click **Advanced Properties**.
7. If the projector is still not projecting the entire image, change the monitor display:
  - a. Verify the resolution setting is lower than or equal to WUXGA (1920 × 1200).
  - b. Switch to the **Monitor** tab.
  - c. Click **Change**.

- d. Click **Show all devices**.
- e. Under the SP box, select **Standard monitor types**.
- f. Under the Models box, select the appropriate resolution mode.
- g. Verify that the resolution setting of the monitor display is lower than or equal to WUXGA (1920 × 1200).

If using a Notebook:

- 1. On the built-in keypad or the IR remote keypad, press **AUTO**.
- 2. Adjust resolution of the computer.
- 3. To send signal out from notebook to projector, press the keys listed below for your Notebook manufacturer (for example, [Fn]+[F4]):

<b>Notebook brand</b>	<b>Function keys</b>
Acer	[Fn]+[F5]
Asus	[Fn]+[F8]
Dell	[Fn]+[F8]
Gateway	[Fn]+[F4]
IBM/Lenovo	[Fn]+[F7]
HP/Compaq	[Fn]+[F4]
NEC	[Fn]+[F3]
Toshiba	[Fn]+[F5]
Mac Apple	System Preference > Display > Arrangement > Mirror display

- 4. If you experience difficulty changing resolutions or your monitor freezes, restart all equipment including the projector.

## Presentation is not displayed

The screen of the Notebook or PowerBook computer is not displaying your presentation.

### Details

Some Notebook computers may deactivate their own screens when a second display device is in use. Each has a different method of reactivation.

### Resolution

Refer to your computer manual for information on changing the method of reactivation.

## Unstable or flickering images

The image is unstable or is flickering when projected.

### Resolution

- To correct the pixels, use the Phase and Clock options.
- Change the monitor color setting on your computer.

## Vertical flickering bar

The image has a vertical, flickering bar when projected.

### Resolution

- Check and reconfigure the display mode of your graphic card to make it compatible with the projector.

## Image is out of focus

The image is out of focus on the screen.

### Resolution

- Adjust the lens focus to fit the screen.
- Make sure the projection screen is between the required distance.

## Image is stretched

The image is stretched when displaying a 16:9 DVD title.

### Details

When you play anamorphic DVD or 16:9 DVD, the projector shows the best image if the projector display mode is set to 16:9 in the on-screen display.

## Resolution

- If you play 4:3 format DVD titles, change the format to 4:3 in the projector on-screen display.
- If the image is still stretched, adjust the aspect ratio by setting the display format as 16:9 (wide) aspect ratio type on your DVD player. For more details, see [Screen menu](#) on page 27.

## Image is not the correct size

The image is too small or too large.

### Resolution

- Adjust the lens zoom to fit.
- Change the position of the projector.

## Connection fail when DHCP on

IP address shows 0.0.0.0 when DHCP is on.

### Resolution

- Make sure RJ45 cable is connected correctly and securely to the projector and the network device.
- Check if there is a DHCP server in this network.
- After checking the steps above, refresh the network setting by turning DHCP off and turning back on.
- Contact your IT engineer if the steps above cannot resolve the network issue.



- Turning off DHCP returns back to default setting if DHCP on fails.

## Connection fail with new IP address

User cannot control the projector after setting up the new IP address manually.

### Resolution

- Make sure RJ45 cable is connected correctly and securely to the projector and the network device.
- Make sure the IP address of projector and the controlling device are set to the same region with different IP addresses.
- Connect the projector directly to the computer. If it is successfully connected, check the network environment.
- Make sure every device has a unique IP address.
- Contact your network engineer if the steps above cannot resolve the network issue.

# Specifications

Learn about the product specifications. Due to continuing research, specifications are subject to change without notice.

## Inputs

The following table details the inputs for DWU500S. RB in the Resolution column indicates reduced blanking.

Resolution	Frame rate (Hz)	VGA	HDMI
640x480	60	V	V
640x480	67	N/A	N/A
640x480	72	V	V
640x480	75	V	V
640x480	85	N/A	N/A
720x400	70	V	N/A
720x480	59.94(29.97)	N/A	N/A
720x576	50(25)	N/A	N/A
800x600	56	V	V
800x600	60	V	V
800x600	72	V	V
800x600	75	V	V
800x600	85	V	N/A
832x624	75	V	V
848x480	50	N/A	N/A
848x480	60	N/A	N/A
848x480	75	N/A	N/A
848x480	85	N/A	N/A
1024x768	60	V	V
1024x768	70	V	V
1024x768	75	V	V

<b>Resolution</b>	<b>Frame rate (Hz)</b>	<b>VGA</b>	<b>HDMI</b>
1024x768	85	V	N/A
1024x768	120	V	V
1152x720	50	N/A	N/A
1152x720	60	N/A	N/A
1152x720	75	N/A	N/A
1152x720	85	N/A	N/A
1152x864	60	N/A	N/A
1152x864	70	N/A	N/A
1152x864	75	N/A	N/A
1152x864	85	N/A	N/A
1152x870	75	V	V
1280x720	50	N/A	V
1280x720	60	N/A	V
1280x720	75	N/A	N/A
1280x720	85	N/A	N/A
1280x720	120	V	V
1280x768	60	N/A	N/A
1280x768	75	N/A	N/A
1280x768	85	N/A	N/A
1280x800	50	N/A	N/A
1280x800	60	V	V
1280x800	75	N/A	N/A
1280x800	85	N/A	N/A
1280x960	50	N/A	N/A
1280x960	60	V	V
1280x960	75	N/A	N/A
1280x960	85	N/A	N/A
1280x1024	50	N/A	N/A
1280x1024	60	V	N/A
1280x1024	72	N/A	N/A
1280x1024	75	V	V
1280x1024	85	N/A	N/A
1360x768	50	N/A	N/A
1360x768	60	N/A	N/A

<b>Resolution</b>	<b>Frame rate (Hz)</b>	<b>VGA</b>	<b>HDMI</b>
1360x768	75	N/A	N/A
1360x768	85	N/A	N/A
1366x768	60	N/A	N/A
1400x1050	50	N/A	N/A
1400x1050	60	V	V
1400x1050	75	N/A	N/A
1440x900	60	V	V
1440x900	75	N/A	N/A
1600x900	60	N/A	N/A
1600x1200	60	V	V
1680x1050	60	N/A	V
1920X1080	24	N/A	N/A
1920X1080	50(25)	N/A	V
1920X1080	60(30)	N/A	V
1920X1200RB	60	N/A	V
1920X1200RB	50	N/A	V
3840x2160	24	N/A	V
3840x2160	25	N/A	V
3840x2160	30	N/A	V
3840x2160	50	N/A	V
3840x2160	60	N/A	V
4096x2160	25	N/A	V
4096x2160	30	N/A	V
4096x2160	50	N/A	V
4096x2160	60	N/A	V



## Key features

- WUXGA 0.67" 1920 × 1200 resolution
- Uses Digital Light Processing (DLP) technology from Texas Instruments
- 4,500 ANSI lumens (typical)
- f/2.4 with Concave mirror, with throw-ratio TR0.25
- Laser-phosphor (LaPh) light source
- The projector can be operated using any of the following:
  - Built-in keypad
  - Infrared (IR) remote control
  - 4-corner adjustment in the on-screen display (OSD)
- Maximum product weight: 5.8 kg (12.8 lbs)

## List of components

This projector comes with all the items listed below. Check to make sure your package is complete. If anything is missing, contact your dealer.

- IR remote control (P/N: 003-005519-XX)
- AC power cord
- Product Safety Guide

Due to the difference in applications for each country, some regions may have different accessories. The following accessory is available for the projector:

- Wall Mount - Silver + white (P/N: 140-147103-XX)

## Physical specifications

Learn the dimensions and weight of the projector.

Description	Dimensions
<b>Projector size</b>	
Overall size (L x W x H) (excluding feet)	383 mm (15.1 in) x 318 mm (12.5 in) x 88 mm (3.5 in)
Overall size, shipping without lens (L x W x H) (includes packaging)	518 mm (20.4 in) x 420 mm (16.5 in) x 328 mm (12.9 in)
<b>Projector Weight</b>	
With Standard lens installed	5.8 kg (12.8 lbs)
Shipping without lens (includes packaging)	7.8 kg (17.2 lbs)
<b>Operating position</b>	
Fixed installation	Static mount in specified orientations with occasional re-location between rooms

## Physical operating environment

Provides specifications for the operating environment.

Item	Specification
Ambient temperature (operating)	0 to 40°C (32 to 104°F) for 0 to 762 meters (0 to 2500 feet)
	5 to 35°C (41 to 95°F) for 762 to 1524 meters (2500 to 5000 feet)
	5 to 30°C (41 to 86°F) for 1524 to 3048 meters (5000 to 10,000 feet)
Storage temperature range	-10 to 60°C (14 to 140°F)
Humidity range	10% to 85% RH (maximum), non condensing
Storage humidity range	5% to 90% RH (maximum), non condensing
Operating altitude	3048 meters (10,000 feet) maximum

## Power requirements

Learn the power requirements for the projector.

Parameter	Requirement
<b>Rated voltage</b>	
Input	100-240V
<b>Rated current</b>	
Input	3.2A maximum
Line frequency	50/60Hz
<b>AC input coupler</b>	
Inrush current	80A maximum
<b>Maximum power consumption</b>	
Input	350W
<b>Maximum power consumption, ECO mode</b>	
Input	250W
<b>Maximum power consumption, LAN mode</b>	
Input	< 2W
<b>Maximum power consumption, Standby mode</b>	
Input	< 0.5W

## Regulatory

This product conforms to the following regulations related to product safety, environmental requirements and electromagnetic compatibility (EMC).

### Safety

- CAN/CSA-C22.2 No. 62368-1-14
- UL 63268-1
- IEC 60950-1 and IEC 62368-1
- EN 62368-1

### Laser Safety

- EU - IEC 60825-1 2014 (3rd)
- EU - IEC 62471-5 2015
- FDA CDRH CFR 1040.10
- FDA CDRH CFR 1040.11

## Electro-Magnetic Compatibility

### Emissions

- FCC CFR47, Part 15, Subpart B/ANSI C63.4, Class A - Unintentional Radiators
- CISPR32/EN55032 Class A - Information Technology Equipment
- ICES/NMB003 (A) - Information Technology Equipment

### Immunity

- CISPR 35/EN55035 EMC Requirements - Information Technology Equipment

## Environmental

- The product conforms to:
  - EU Directive (2011/65/EU) on the restriction of the use of certain hazardous substances (RoHS) in electrical and electronic equipment and the applicable official amendment(s).
  - EU Regulation (EC) No. 1907/2006 on the registration, evaluation, authorization and restriction of chemicals (REACH) and the applicable official amendment(s).
  - EU Directive (2012/19/EU) on waste and electrical and electronic equipment (WEEE) and the applicable official amendment(s).
  - China Ministry of Information Industry Order No.39 (02/2006) on the control of pollution caused by electronic information products, the hazardous substances concentration limits (SJ/T11363-2006), and the applicable product marking requirement (SJ/T11364-2006).

## Marking

- This product conforms to all relevant Canadian, US, and European directives, standards, safety, health and environmental concerns. International packaging recycling marks conform to:
  - EU Directive (2012/19/EU) on waste and electrical and electronic equipment (WEEE).
  - EU Directive (94/62/EC) on packaging and packaging waste.
  - China packaging recycling mark standard (GB18455-2001).

## Federal Communications Commission (FCC) warning

- The product has been tested and found to comply with the limits for a Class A digital device, pursuant to Part 15 of the FCC Rules. These limits are designed to provide reasonable protection against harmful interference when the product is operated in a commercial environment. The product generates, uses, and can radiate radio frequency energy and, if not installed and used in accordance with the instruction manual, may cause harmful interference to radio communications. Operation of the product in a residential area is likely to cause harmful interference in which case the user will be required to correct the interference at the user's own expense.

## Notice: Canadian users

- This Class A digital apparatus complies with Canadian ICES-003.

## Remarque à l'intention des utilisateurs canadiens

- Cet appareil numérique de la classe A est conforme à la norme NMB-003 du Canada.

## Declaration of Conformity for EU countries

- EMC Directive 2014/30/EU (including amendments)
- Low Voltage Directive 2014/35/EU
- Radio Equipment Directive (RED) 2014/53/EU (if product has RF function)
- RoHS Directive 2011/65/EU

## CE Notice

- This product is herewith confirmed to comply with the requirements set out in the Council Directives on the Approximation of the laws of the Member States relating to Electromagnetic Compatibility Directive 2004/108/EEC.

### **Warning**

- This product must not be used in residential areas.
- This product may cause interference if used in residential areas.
- Such use must be avoided unless the user takes special measures to reduce electromagnetic emissions to prevent interference to the reception of radio and television broadcasts.

## On-screen display tree

The following table provides the on-screen display menu.

1st level	2nd level	3rd level	4th level
Picture	Color mode	Bright	
		Presentation	
		Movie	
		Game	
		User	
	Wall Color	White	
		Light Yellow	
		Light Blue	
		Pink	
		Dark Green	
	Brightness	0 to 100	
	Contrast	0 to 100	
	Sharpness	0 to 31	
	Color	0 to 100	
	Tint	0 to 100	
	Gamma	0 to 4	
	Color Temp	Low	
		Mid	
		High	
	Color Setting	Red/Green/Blue/Cyan/Magenta/Yellow/White	
		Hue (Red for White)	H: -99 to 99; W: 0 to 199
		Saturation (Green for White)	0 to 199
		Gain (Blue for White)	0 to 199
	Aspect Ratio	Auto	
		4:3	
		16:9	
		16:10	
	Phase	Defined by signal	
	Clock	Defined by signal	
	H.Position	Defined by signal	
	V.Position	Defined by signal	

1st level	2nd level	3rd level	4th level	
Picture	Digital Zoom	0 to 10		
	Geometric Correction	V. Keystone		-40 to 40
		H. Keystone		-40 to 40
		4 Corner On/Off		On
				Off
		Grid Color		White
				Green
				Red
			Purple	
	4 Corner Adjust		Pattern for adjust	
	4 Corner Reset		Yes	
			No	
	Orientation	Front		
		Front Ceiling		
		Rear		
		Rear Ceiling		
	Size	-25, 0		
Image Shift	H. Position		-200 to 200	
	V. Position		-60 to 60	
Settings	Language	English		
		German		
		Swedish		
		French		
		Arabic		
		Dutch		
		Norwegian		
		Danish		
		Simplified Chinese		
		Polish		
		Korean		
		Russian		
		Spanish		
		Traditional Chinese		
Italian				



<b>1st level</b>	<b>2nd level</b>	<b>3rd level</b>	<b>4th level</b>
Settings	Language	Portuguese	
		Turkish	
		Japanese	
	Screen type	16:9	
		16:10	
	Menu Location	Left Top	
		Right Top	
		Center	
		Left Bottom	
		Right Bottom	
	LAN (Standby)	On	
		Off	
	VGA OUT (Standby)	On	
		Off	
	Test Pattern	On	
		Off	
	Signal Power On	On	
		Off	
	Direct Power On	On	
		Off	
	Security	Security	
			Off
Security Timer			Input time
	Change password		Input password
Remote Sensor	Front		
	Top		
Reset	Yes		
	No		
Volume	Output	Speaker	
		Line Out	
	Microphone	On	
		Off	
	Mute	On	
		Off	

1st level	2nd level	3rd level	4th level
Volume	Volume	0 to 30	
	Microphone Volume	0 to 30	
Options	Logo	Default	
		User	
	Auto Source	On	
		Off	
	HDMI settings	HDMI1	1.4
		HDMI1	2.0
		HDMI2	1.4
		HDMI2	2.0
	Auto Power Off (min)	0 to 120	
	Sleep Timer	0 to 990	
	SSI Settings	SSI Hours Used (Normal)	
		SSI Hours Used (ECO)	
		SSI Power Mode	Normal ECO
		Constant Luminance	On Off
	High Attitude	Popup On/Off	
Filter Remind(Hour)	Filter Reminder (0 to 1000)		
	Cleaning up reminder	Yes No	
Information	(Display only)		
Projector ID	Value adjust		
3D	3D	On	
		Off	
		Auto	
	3D Tech.	DLP-Link	
		Off	
	3D Invert	On	
Off			

1st level	2nd level	3rd level	4th level
3D	3D Format	Frame Packing	
		Side-by-Side (Half)	
		Top and Bottom	
		Frame Sequential	
		Field Sequential	
	1080P@24	96Hz	
		144Hz	
LAN	Status	(Display only)	
	DHCP	On	
		Off	
	IP Address	Editable	
	Subnet Mask	Editable	
	Gateway	Editable	
	DNS	Editable	
	Store	Yes	
		No	
	MAC Address	(Display only)	
	Group Name	(Display only)	
	Projector Name	(Display only)	
	Location	(Display only)	
	Contact	(Display only)	
Reset	Yes		
	No		