

Christie CP2208

Digital cinema
Alternative/local content
Post production



A compact digital cinema projection solution with global appeal

Investing in a new digital cinema projection system that meets DCI standards can be a significant investment - especially if distributor-backed financing isn't available. Christie® has created an affordable and compact DCI-compliant solution to deliver audience-captivating content in theaters around the world.

The Christie CP2208 gives theater owners a choice of lens and Xenon lamp options, as well as an optional integrated media block (IMB-S2) with easy-to-operate Screen Management Software (SMS). As a compact solution, the CP2208 projector provides the lowest cost of ownership on the market for affordable digital conversion.

CHRISTIE®

Christie CP2208

With the ability to display DCI, 3D, High Frame Rate (HFR), alternative and local content, this projector takes superior performance coupled with flexibility and affordability to a new level. Feature film content can be displayed using the optional Christie integrated media block (IMB-S2)¹ or another popular Series-2 integrated media block (IMB) system² using the open IMB slot. This will help to reduce your overall system cost and increase overall system reliability. The Christie CP2208 also offers HFR upgrade capabilities and support for advertising and alternative content. For external alternative content sources, the Christie CP2208 has dual DVI/HDMI inputs, configurable for both 2D and 3D operation.

Christie CP2208 supports all external 3D systems. If you require higher brightness for 3D presentations, Christie CP2208 projectors can be stacked for a stunning 3D presentation.

Specifications		Christie CP2208
Brightness	lamps	<ul style="list-style-type: none"> • CDXL-14M (003-003066-01) • CDXL-16M (003-003900-01) • CDXL-19SC (003-005366-01) • CDXL-21S1 (003-004258-01)
	nominal	• Up to 9000 DCI lumens; 10,000 native lumens
	maximum screen size	• 35ft/10.67m @ 1.0 screen gain
Contrast ratio		• >1700:1 full field on/off
Digital micromirror device		<ul style="list-style-type: none"> • 0.69" S2K 3-chip DMD DLP Cinema* • 2048 x 1080 pixels
Number of colors		• 35.2 trillion
Lens mount configuration		• Fully motorized intelligent lens system (ILS)
Lenses		<ul style="list-style-type: none"> • 1.2-1.72 (108-494108-01) • 1.33-2.1 (108-495109-01) • 1.62-2.7 (108-496100-01) • 2.09-3.9 (108-497101-01)
Input line voltage		• Single phase 220V
Lamp power supply		• 700W-2.3kW low-ripple switch mode lamp power supply
Weight		• As installed: 119lbs (53.75kg)
Size		• (LxWxH): 27.4 x 27.1 x 15.6" (697 x 688 x 395 mm)
Accessories		<ul style="list-style-type: none"> • Christie IMB-S2 (108-384107-03) • NAS-S2 4TB storage (108-502108-02) • HFR software upgrade • 90-degree extraction duct adapter (119-103105-01) • Rack mount stand (108-416102-01)

¹ DCI-compliant NAS storage systems available through your Christie sales representative.
² Dolby, Doremi or GDC IMB systems.

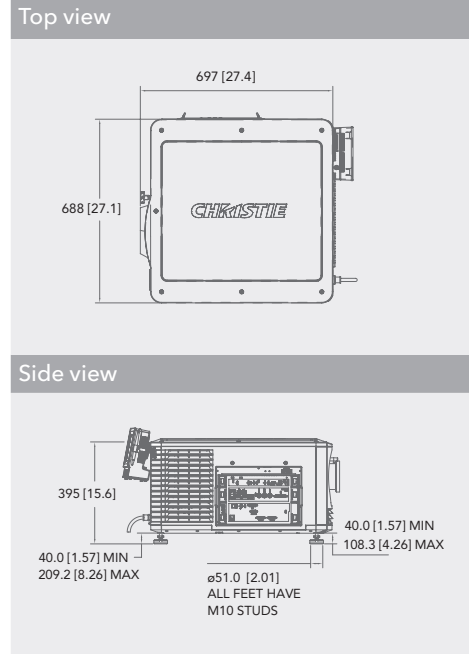

Key features:

- Fully DCI-compliant
- Choose from 5 Xenon lamp options
- 3D ready
- Low cost of ownership
- Motorized lens mount
- Open IMB slot
- Optional integrated media block with SMS and high-performance NAS storage
- Touch panel controller with intuitive Graphical User Interface (GUI)
- HFR capable
- Standard support for HDCP
- Quick, easy rear access to the lamp
- Washable/reusable filters
- Backed by a dedicated technical support team

United Kingdom
 Branch & EMEA
 Head Office
 ViewPoint
 200 Ashville Way
 Wokingham
 Berkshire, U.K.
 RG41 2PL
 PH: +44 (0) 118 977 8000

Middle East
 Light Industrial Unit (LIU-17)
 Nad Al Shibba
 Sheikh Mohammed Bin Zayed Road
 Dubai Silicon Oasis
 PO Box: 293762
 Dubai - U.A.E
 PH: +971 (0) 4 503 6800

Africa
 Unit C3
 Northlands Deco Park
 New Market Road
 Northriding
 Randburg
 2164
 Johannesburg
 Gauteng
 South Africa
 PH: +27 71 335 8667

Other EMEA offices

Germany
 Branch Office
 PH: +49 2161 566 200

France
 Branch Office
 PH: +33 (0) 1 41 21 44 04

Eastern Europe
 Representative Office
 PH: +36 (0)1 47 48 138

Spain
 Branch Office
 PH: +34 91 633 9990

Italy
 Independent Sales Consultant Office
 PH: +39 (0) 2 9902 1161

Russia
 Independent Sales Consultant Office
 PH: +7 (495) 930-8961



For the most current specification information, please visit www.christieemea.com