

Christie G Series

Boardrooms
Conference rooms
Education
Government

Houses of worship
Museums
Training rooms



CHRISTIE®

Unsurpassed value, versatility and long-life performance

What does value mean to you? We think it's the fine balance between quality, performance, support and cost. The Christie® G Series offers you unsurpassed value – with energy saving features, low maintenance costs, numerous standard features, and the best warranty and support in the industry.

Built with proven DLP® technology, the Christie G Series gives you excellent image quality and reliability. At 6000 lumens, this is the brightest platform in its category.

Ideal for 24/7 operation, the filter-free, dust-sealed design prevents dust and dirt from affecting the projector, ensuring that image quality is preserved and maintenance costs are minimal.

Shipping with standard zoom lens, the Christie G Series is packed with ProAV features, including three resolution options, built-in color matching for a more uniform image in a multi-projector configuration, and blending and warping capabilities to handle curved surfaces.

High brightness

The brightest in its class, the Christie G Series delivers exceptional images.

Christie DWX600-G - 6150 ANSI lumens (6400 center lumens)
Christie DHD600-G - 5950 ANSI lumens (6200 center lumens)
Christie DWU600-G - 6050 ANSI lumens (6300 center lumens)

Six-segment color wheel

Comes with high-brightness color wheel for standard applications and uses.

Three resolution options

WXGA model	Amazing performance value
Native HD model	Maintain and maximize your brightness
WUXGA model	Ideal for graphic intensive applications

Color matching

When used with multiple projectors, this feature ensures accurate color matching and uniformity across the entire image.

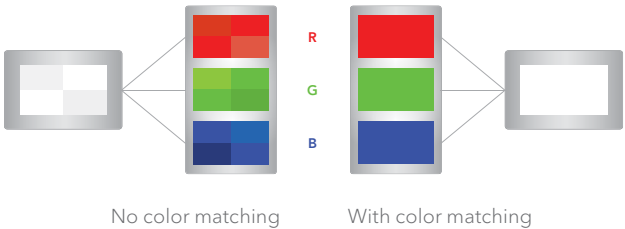

Constant intensity mode

For tiled arrays, the constant intensity mode automatically increases brightness as the lamps wear out over time in order to maintain the overall brightness and image consistency across the display.

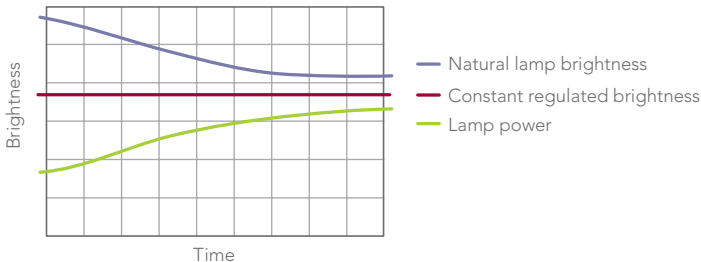



Dynamic Contrast

The Dynamic Contrast feature further enhances the image quality of the Christie G Series by increasing the contrast ratio to 4800:1. This series ships standard with a high-brightness, six-segment color wheel for maximum brightness and excellent color range.

Ideal for video applications, the Dynamic Contrast automatically adjusts an internal iris to extend the range of blacks and provide richer details during dark content for true image reproduction.

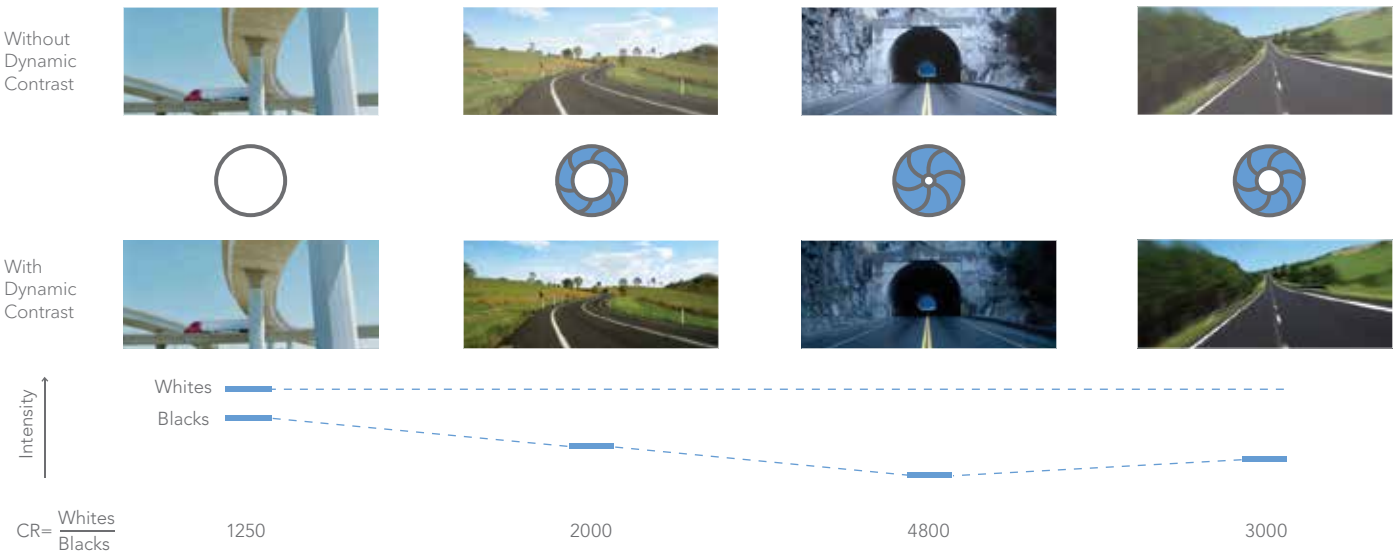

We understand the unique needs of your application

No application requirements are the same. We strive to pack all the features crucial to the success of your display into one compact chassis minimizing the expense of purchasing additional “out of projector” technologies. The Christie G Series is the full package.

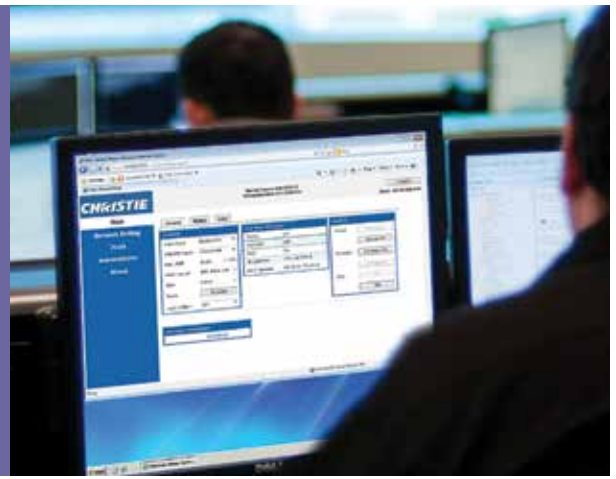

24/7 use capability

The Christie G Series offers sealed, dust-free housing and heat-pipe cooling system that enables the projector to run 24 hours a day, 7 days a week in continuous operation.

360 degree projection

The Christie G Series can project from a table top, be ceiling mounted, straight down or straight up. However you spin it, the Christie G Series will fit your needs.

Christie Presenter

The Christie Presenter application allows up to four remote desktops from host PC's to be displayed on the network through Ethernet, USB, or wireless transports. It can adapt to different network settings (DHCP, fixed IP, and direct link by USB/Ethernet cable).

Wireless projection

- Easy connectivity
- Less cluttered meeting space
- Cable-free management

Projector control

- Control the projector through a web-user interface
- SNMP (simple network management protocol) lets you remotely monitor a Christie projector and get status changes on various parameters

Motorized zoom, focus and lens shifts

For easy installation and configuration, the Christie G Series comes with motorized zoom, focus and lens shift to ensure your image is aligned tight within the desired viewing area for every presentation. The mechanical shutter allows for quick pauses in your display when the need arises to shutter the image.

Picture-in-picture/picture-by-picture functions offer different layout options

A30H PIP/PBP Matrix	Main									
	HDMI	VGA	Component	S-video	CVBS	RJ45	USB type B (mini)	USB type A	DisplayPort	DVI-D
HDMI	-	-	-	-	-	•	•	•	•	•
VGA	-	-	-	-	-	•	•	•	•	•
Component	-	-	-	-	-	•	•	•	•	•
S-video	-	-	-	-	-	•	•	•	•	•
CVBS	-	-	-	-	-	•	•	•	•	•
RJ45	•	•	•	•	•	-	-	-	-	-
USB type B (mini)	•	•	•	•	•	-	-	-	-	-
USB type A	•	•	•	•	•	-	-	-	-	-
DisplayPort	•	•	•	•	•	-	-	-	-	-
DVI-D	•	•	•	•	•	-	-	-	-	-

• = PIP/PBP combinations are enabled

- = PIP/PBP combinations are disabled

- 1 Remote in
- 2 Remote out
- 3 Red/Pr
- 4 Blue/Pb
- 5 Green/Y
- 6 CVBS
- 7 S-video
- 8 RS-232
- 9 Ethernet
- 10 Mini USB
- 11 USB
- 12 DisplayPort
- 13 HDMI
- 14 VGA-IN
- 15 VGA-OUT
- 16 DVI



Blending and warping capabilities (optional)

Coupled with the internal color matching functions, blend and warp capabilities enable the projector to be used in high-end applications where large images are needed. An optional dual processor warp module is required to blend and warp displays.



▲ Dual processor warp module

Warp modes: Keystone, 4-Corner, Curve, Pincushion, Barrel and Rotation¹

Projection surface	Warping capabilities
<p>Curved screens</p>	
<p>Tilted screen</p>	

¹ Reference User Manual for combination compatibility of warp modes.

A suite of lens options to choose from

Our suite of lenses for HD and WUXGA resolutions increases installation flexibility. Christie G Series ships with a standard 1.22-1.52:1 zoom lens.

Accessories and options

Description	Part Number	
Lenses	0.95-1.22 zoom	140-101103-01
	1.22-1.52 zoom	140-100102-01
	1.52-2.89 zoom	140-102104-01
	2.90-5.50:1 zoom	104-107109-01
Ceiling mount	140-105107-01	
Ceiling mount extension	104-101001-XX	
Dual processor warp module	133-111104-01	
Wireless dongle	133-113106-01	
Cable cover	140-103105-01	
Lamp	003-004808-01	



▲ Full suite of lenses

▲ Christie G Series cable cover

Front view

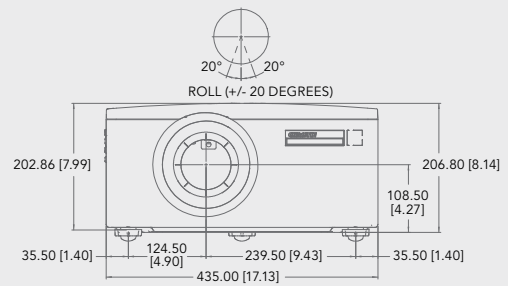

Side view¹

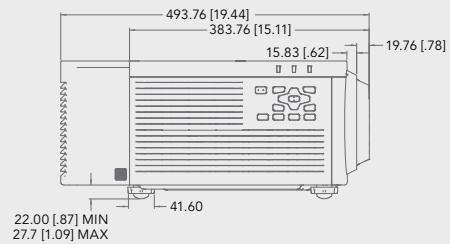

Top view¹

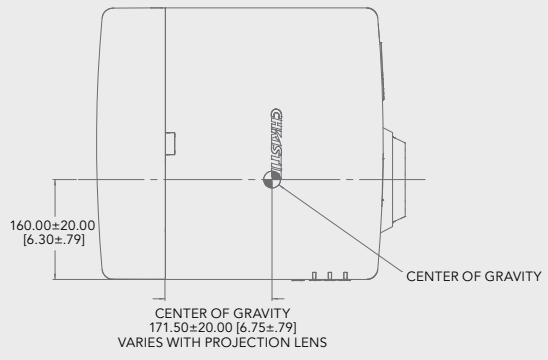

Underneath view¹

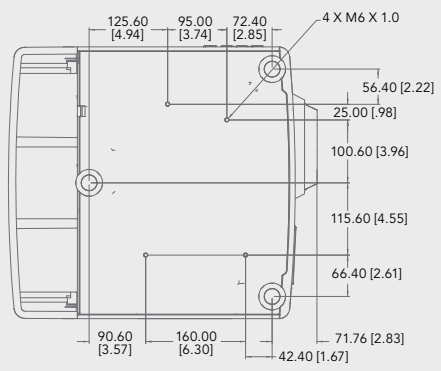

¹ Projector shown with optional cable cover.

Going above and beyond

We care about our customers. Your satisfaction is our ultimate goal. We stand behind our products with our second-to-none warranty and service programs.

Christie support and service

All Christie products are backed by industry-leading warranties and our renowned service. We ensure you have all the training, service and technical support you need. Christie has local technicians on five continents for international installations and global deployments.



Environmental responsibility

At Christie® we recognize our responsibility to control the impact of our business on the environment. We take pride in offering eco-friendly features in our products that are not only good for the environment, but also translate to a lower total cost of ownership for our customers.

		Christie DWX600-G	Christie DHD600-G	Christie DWU600-G
Image	brightness	• 6150 ANSI lumens (6400 center lumens)	• 5950 ANSI lumens (6200 center lumens)	• 6050 ANSI lumens (6300 center lumens)
	color wheel	• 6 Segment (RGBCYW)		
	contrast	• 4000:1 (Dynamic Contrast Enabled); 1000:1 (full on/off); 250:1 ANSI	• 4800:1 (Dynamic Contrast Enabled); 1200:1 (full on/off); 250:1 ANSI	
Display	type	• 1-chip 0.65" DMD		• 1-chip 0.67" DMD
	native resolution	• 1280 x 800 (1,024,000 pixels) 16:10	• 1920 x 1080 (2,073,600 pixels) 16:9	• 1920 x 1200 (2,304,000 pixels) 16:10
Lamp	type	• 465W NSH		
	typical lifetime	• 2000 hrs typical @ 465W • 2500 hrs typical @ 360W		
Inputs	standard	• HDMI x 1 • DVI-D x 1 (Digital only) • DisplayPort x 1 • HD15 x 1 • Composite video x 1 (RCA) • S-Video x 1 (mini DIN) • Component video (RCA) • USB x 1 (type B mini) - Display over USB • USB x 1 (type A) - Image viewer or Wi-Fi dongle (optional) • RJ45 x 1		
	signals	• HDTV formats VGA through to WUXGA (1920 x 1200) • Horizontal and vertical scaling while maintaining aspect ratio, all inputs		
	pixel clock	• 162 MHz		
	scan rates	• Horizontal: 15-100kHz • Vertical: 24-85Hz		
Outputs	monitor out	• HD15 x 1		
Control and networking		• RS-232 in • Ethernet (10/100) RJ45 with ChristieNET™ connectivity • Built-in backlit keypad • Wired remote control (3.5mm stereo)		
Accessories	standard	• IR Remote with wired remote jack (wire not included) • AC Line cord for projector head • User manual		
	optional	• 1DWUSB-BGN (wireless dongle for video and control) • Warp module • Cable cover • Ceiling mount • Ceiling mount extension		
Lens mount	type	• Tool-free lens insertion system • Boresight adjustable • Motorized horizontal and vertical lens offset • Motorized zoom and focus adjustment		
Lenses	zoom	• 1.22-1.52:1 HD (included) • 0.95-1.22:1 HD (optional) • 1.52-2.89:1 HD (optional) • 2.90-5.50:1 HD (optional)		
	offsets	• Vertical: ± 100% (± 400 pixels)	• Vertical: ± 120% (± 648 pixels)	• Vertical: ± 100% (± 600 pixels)
		• Horizontal: ± 20% (± 128 pixels)	• Horizontal: ± 20% (± 192 pixels)	• Horizontal: ± 20% (± 192 pixels)
Power requirements	operating voltage	• 100-240 VAC 50/60Hz		
	consumption	• 580W maximum • 450W eco mode		
	operating current	• 6.5A maximum		
	dissipation	• 1979 BTU/hr maximum • 1535 BTU/hr eco mode		
Physical	size	• (LxWxH) 15.28 x 17.13 x 8.15" (388 x 435 x 207mm) without feet		
	shipping size	• (LxWxH) 23.27 x 23.03 x 17.44" (591 x 501 x 443mm)		
	weight	• 33.7lbs (15.3kg)		
	shipping weight	• 45.2lbs (20.5kg)		
Operating environment		• Temperature: 40-95°F (5-35°C) • Humidity: 10-85% non-condensing		
Regulatory ²		• UL/CSA/IEC 60950-1 • FCC Class A, CE, CCC, KC, EAC, PSE, CU, SABS, BIS, and RCM • This product conforms to all relevant European directives, standards, safety, health and environmental concerns • This product is designed to comply to the rules and regulations required for the product to be sold in various regional markets, including USA/Canada, EU, Norway, Australia/New Zealand, Kuwait, China, Korea, Japan, Mexico, Ukraine, India, Russia, South Africa and Saudi Arabia • RoHS, REACH, WEEE		
Limited warranty		• Three years parts and labor (including light engine) • Lamp: 500 hours or one year (whichever comes first) • Contact an authorized Christie representative for full details of our limited warranty		

² Some certifications are pending. Please contact Christie for currently approved certifications.



United Kingdom
Branch & EMEA
Head Office
ViewPoint
200 Ashville Way
Wokingham
Berkshire, U.K.
RG41 2PL
PH: +44 (0) 118 977 8000

Middle East
Light Industrial Unit (LIU-17)
Nad Al Shibba
Sheikh Mohammed Bin Zayed Road
Dubai Silicon Oasis
P.O. Box: 293762
Dubai - U.A.E
PH: +971 (0) 4 503 6800

Africa
Unit C3
Northlands Deco Park
New Market Road
Northriding
Randburg
2164
Johannesburg
Gauteng
South Africa
PH: +27 71 335 8667

Other EMEA offices

Germany
Branch Office
PH: +49 2161 566 200

France
Branch Office
PH: +33 (0) 1 41 21 44 04

Eastern Europe
Representative Office
PH: +36 (0)1 47 48 138

Spain
Branch Office
PH: +34 91 633 9990

Italy
Independent Sales Consultant Office
PH: +39 (0) 2 9902 1161

Russia
Independent Sales Consultant Office
PH: +7 (495) 930-8961



For the most current specification information, please visit www.christieemea.com

Copyright 2016 Christie Digital Systems USA, Inc. All rights reserved. All brand names and product names are trademarks, registered trademarks or tradenames of their respective holders. Christie Digital Systems Canada Inc.'s management system is registered to ISO 9001 and ISO 14001. Performance specifications are typical. Due to constant research, specifications are subject to change without notice. Printed in Canada on recycled paper. 4397 Nov-16

CHRISTIE®